

Pine Trunk

By Al Krogh



Rip Boards

Step 1 - Use four 1" x 4" x 8' pine boards for the box sides and ends (A, B). Select boards with tight knots and a pleasing grain pattern. Cut two 32" lengths from each of the boards. You will have 8 side pieces total. However, do not cut the 14" lengths for the box ends from the remainder of the boards at this time.



Make Spacer Jig

Step 2 - Joint one edge of the eight 32" side pieces, as well as the 2 remaining lengths of boards.
Step 3 - You may find quite a bit of width variation between boards. Because of the interlocking corner construction (finger joints) of the box carcass, the lumber must be identical in width. Rip the boards to a common width on the table saw, but take



Assemble Jig

off as little as possible, using the narrowest board as the standard, as shown in photo A.
Step 4 - Cut two 14" sections from each of the four remaining lengths. Do not discard the waste cutoffs. These cutoffs will be used to make a jig for gluing up the sides and ends in step 5.

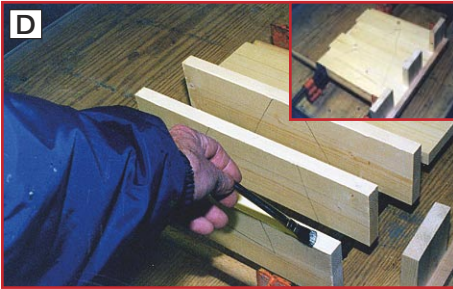

Glue and Clamp

Step 5 - To make the spacer jig, lay a box end out on a surface, and insert 3 waste pieces between every other board, as shown in photo B. Take a scrap piece of $\frac{3}{4}$ " x $\frac{3}{4}$ " x 17" lumber, and screw from the back into the spacer jig pieces, as shown in photo C. This jig will ensure the proper amount of overlap for the finger joints and will keep the assembly square during the gluing process.

Step 6 - Apply wood glue (N) to the edges of the boards, as shown in photo D, taking care not to apply glue to the surfaces of the sides and ends that overlap to form the finger joints. Loosely clamp the assembly together. Insert the spacer jig in between

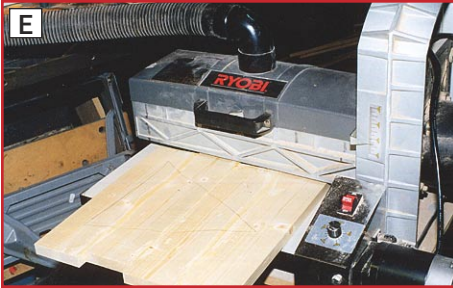

Plane Surface

the boards, making sure that everything is tight, and tighten the clamps, as shown in photo D inset. Remove the spacer jig before the glue sets up, and move on to the next assembly.

Step 7 - After the glue has set up, flatten the surfaces of the sides and ends using a belt sander or a planer, as shown in photo E. Assemble the box for a test fit, making sure the box is square and the finger joints fit. Because of the sanding, the interlocking fingers of the corners may "stand proud" of the box surface, but that will be taken care of after the final assembly. Perform the final finish sanding on the interior surfaces of the box at this time.

Material List		T x W x L
A	box ends (8) <i>pine</i>	$\frac{3}{4}$ " x $3\frac{1}{2}$ " x 14"
B	box sides (8) <i>pine</i>	$\frac{3}{4}$ " x $3\frac{1}{2}$ " x 32"
C	box corner braces (4) <i>pine</i>	$\frac{3}{4}$ " x $\frac{3}{4}$ " x 12"
D	end lid frame cleats (2) <i>pine</i>	$\frac{3}{4}$ " x $\frac{7}{8}$ " x $11\frac{1}{2}$ "
E	back lid frame cleat <i>pine</i>	$\frac{3}{4}$ " x $\frac{7}{8}$ " x 29"
F	lid frame back <i>pine</i>	$\frac{3}{4}$ " x 3" x $28\frac{1}{2}$ "
G	lid frame sides (2) <i>pine</i>	$\frac{3}{4}$ " x $2\frac{1}{2}$ " x 15"
H	top upright* <i>pine</i>	$\frac{3}{4}$ " x $5\frac{1}{2}$ " x $33\frac{1}{2}$ "
I	box bottom <i>plywood</i>	$\frac{1}{4}$ " x $13\frac{1}{4}$ " x $31\frac{1}{4}$ "
J	base front and back (2) <i>pine</i>	$\frac{3}{4}$ " x $3\frac{1}{2}$ " x $30\frac{1}{2}$ "
K	base ends (2) <i>pine</i>	$\frac{3}{4}$ " x $3\frac{1}{2}$ " x $12\frac{1}{2}$ "
L	base corners (4) <i>pine</i>	$\frac{3}{4}$ " x $\frac{3}{4}$ " x $3\frac{1}{2}$ "
M	lid (4) <i>pine</i>	$\frac{3}{4}$ " x $3\frac{1}{2}$ " x $28\frac{1}{2}$ "

Supply List	
N	wood glue
O	liquid hide glue
P	panhead face frame screws (50) #6 x $1\frac{1}{4}$ "
Q	biscuits (2) #0
R	piano hinge $1\frac{1}{2}$ " x $28\frac{1}{2}$ "
S	paint, stain, and varnish **

*Pattern needed for this project is located in the pattern packet starting on page 35.

**Items are listed in our Buyers Guide on page 78.

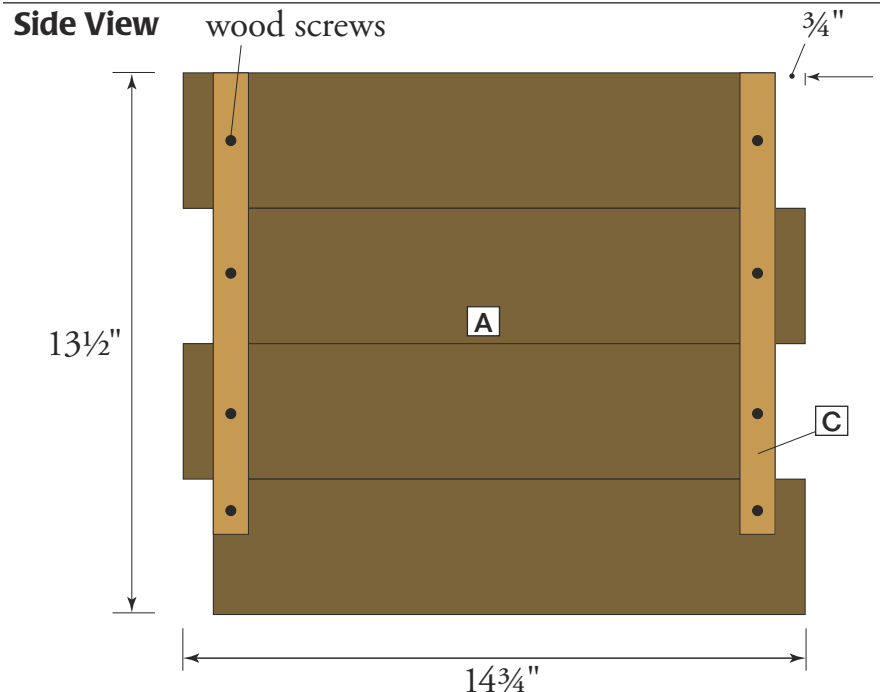

Pine Trunk



Round Over Edges

Step 8 - Cut the box corner braces (C) to the dimensions given in the material list. Round one edge of each length using a router and a $\frac{3}{8}$ " round-over bit, as shown in photo F. Pre-drill four $\frac{1}{8}$ " holes on the sides that mate with the box sides and ends, making sure that each one of the

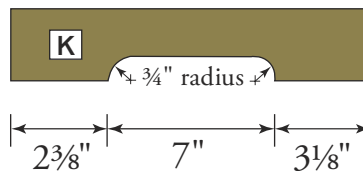
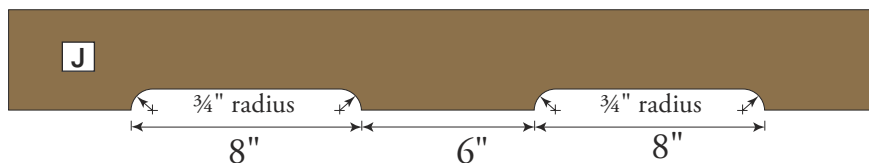

Base Front, Back and Ends Front View



Pre-Drill

four screws (P), will drive into a different board on the sides and ends, as shown in photo G.

Step 9 - Fasten the strips onto the end units, making sure that the edges line up with the indented portion of the corner and that the top of the strip is flush with the top of the box corner, as shown in photo H.



Fasten Strips

Step 10 - Apply glue to the mating surfaces and assemble, as shown in photo I. We used liquid hide glue (O) for this step because of the extended set-up time. Use as many clamps as necessary to square the structure before screwing it together, as shown in photo I insets. After the glue has cured, move to another end.

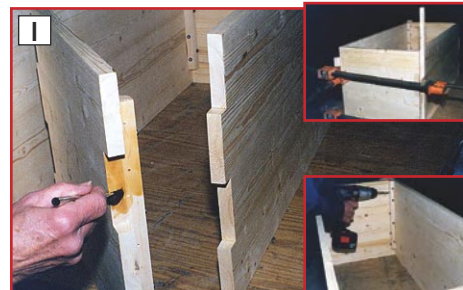

Glue and Assemble

Step 11 - When the box joints are cured, sand the finger joint extension flush with the surfaces of the sides and ends if needed. Use a $\frac{3}{8}$ " round-over router bit to round over the corners and bottom edge of the box, as shown in photo J.



Sand Finger Joints

Step 12 - Cut the end and back lid frame cleats (D, E) to the dimensions given in the material list. Install the cleats flush with the top edge, using glue and screws, as shown in photos K and K inset. These cleats will be used to fasten the lid frame to the box carcass.



Attach Framing Cleats

Step 13 - Cut the lid frame back (F) and lid frame sides (G) to the dimensions given in the material list. Refer to the lid frame drawing for the biscuit locations. Cut the #0 biscuit slots (Q), as shown in photo L. Glue and clamp, making sure the frame is square. When the glue joints have cured,



Insert Biscuits

round the outside front corner of the frame ends, and run a $\frac{1}{8}$ " round-over bit along the outside top edges of the lid frame. Then sand the exposed portions.

Step 14 - Cut the top upright (H) to the dimensions given in the material list. Locate the pattern for the top upright in

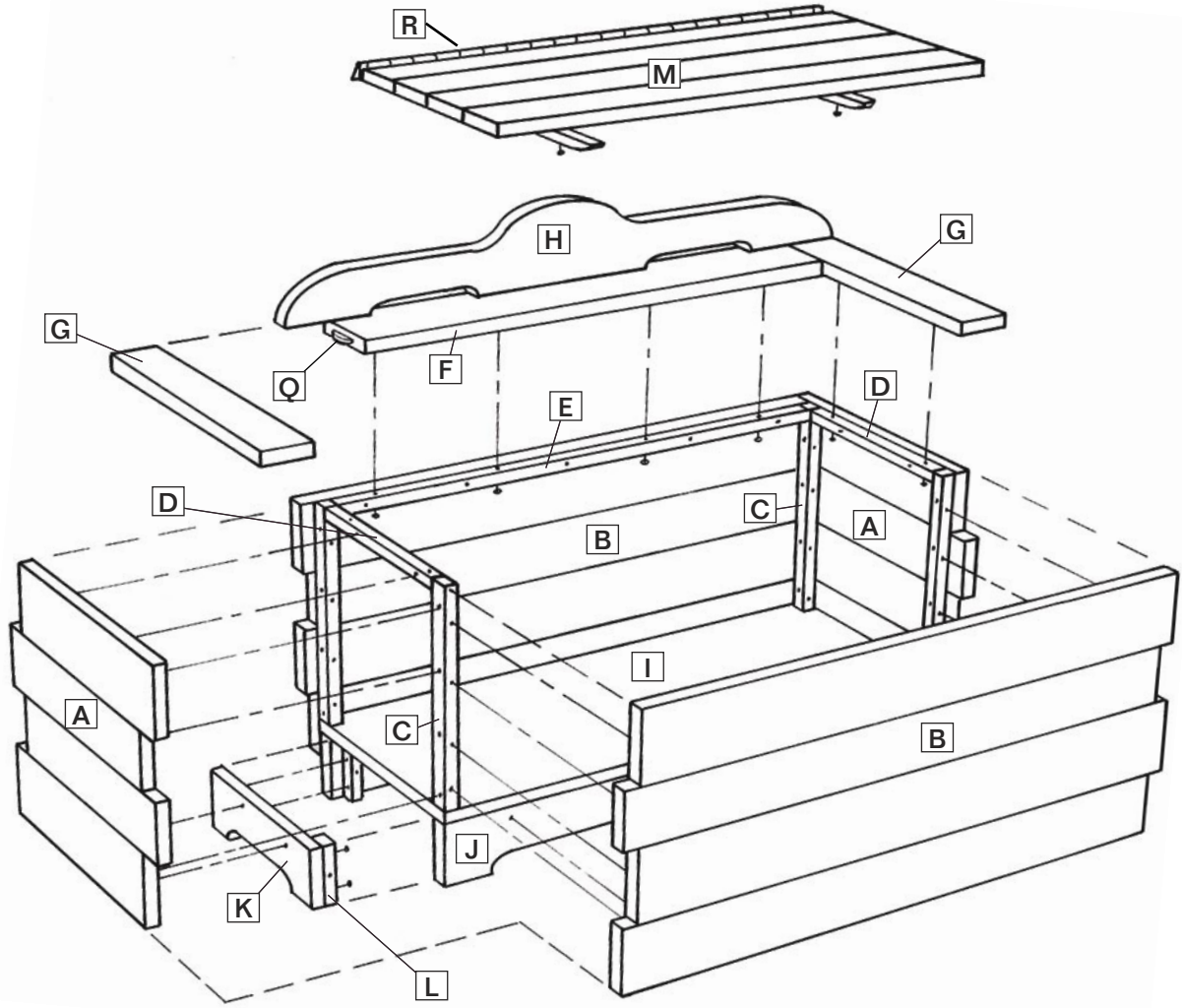

Exploded View



Cut Top Upright

the pattern packet and trace pattern onto the blank. Cut along pattern lines using a band saw or a jig saw, as shown in photo M. Sand the edges smooth. Use a router with a 3/8" round-over router bit on both sides of the curved portions of the upright, as shown in photo N.



Rout Top Upright

Step 15 - Mount the top upright to the lid frame by pre-drilling through the frame piece, as shown in photo O.



Pre-Drill Lid Frame

Step 16 - Flip piece over and apply glue to the mating surfaces. Screw through the bottom of the lid frame into the top upright, as shown in photo P.

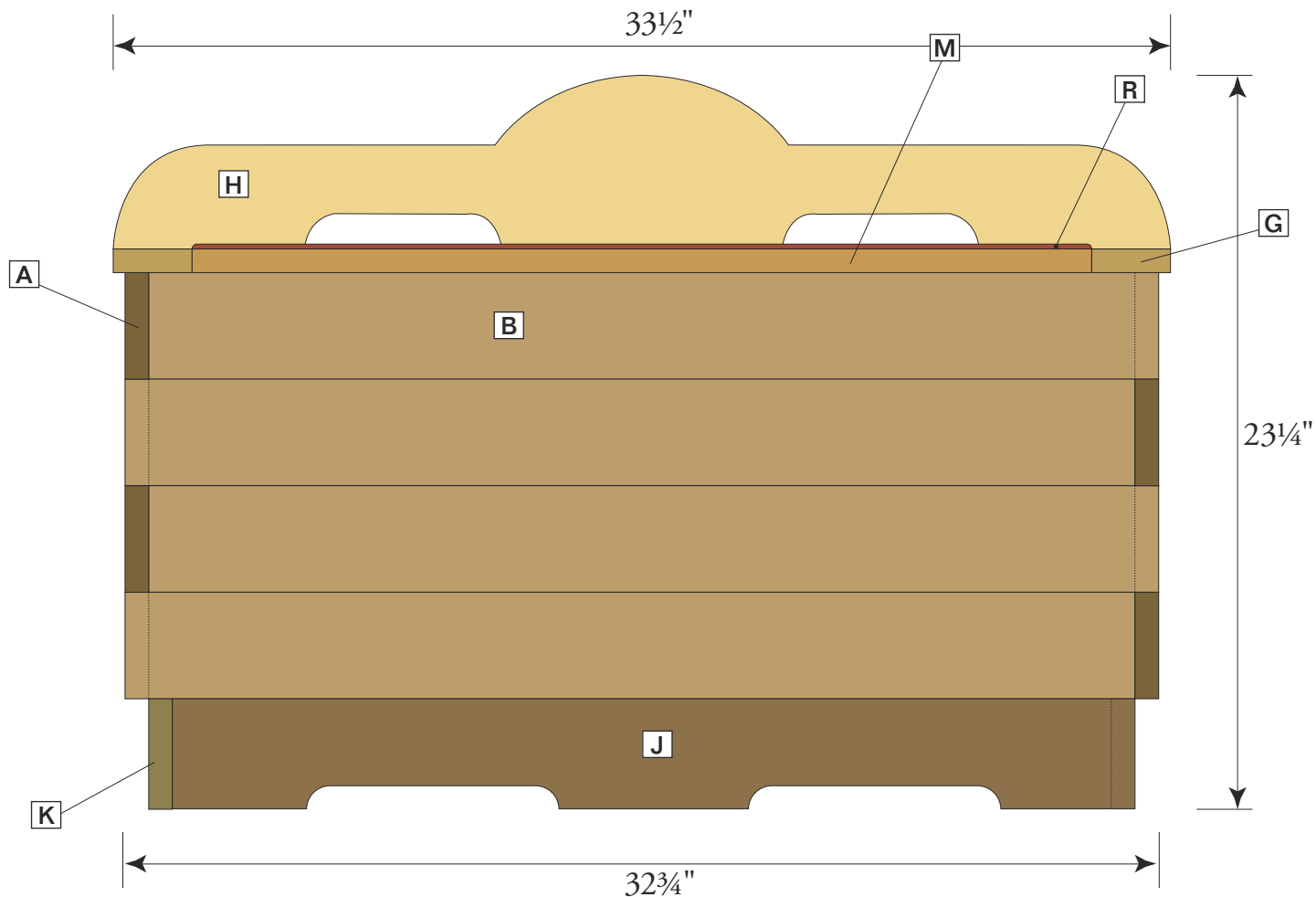

Front View



Mount Top Upright

Step 17 - Turn the box carcass upside down on a flat surface, and slide the frame unit underneath. It should extend $\frac{3}{8}$ " beyond the front and sides of the box and should be flush at the back. Mark the position, remove the frame, and apply glue to the mating surfaces. Place the frame back into position, and drive screws (N) through



Attach the Frame

the bottom of the cleats into the frame, as shown in photo Q.
Step 18 - Cut the box bottom (I) to the dimensions given in the material list, and set it in place, as shown in photo R. The floor should sit against the bottom of the corner cleats.



Place Box Bottom

Step 19 - Cut the base front, back and end pieces (J, K) to the dimensions given in the material list. Refer to the drawing on page 18 for the cut outs and lay out the cutout portions on each piece, keeping in mind that the base construction will be the same as the box; that is, alternating end grain

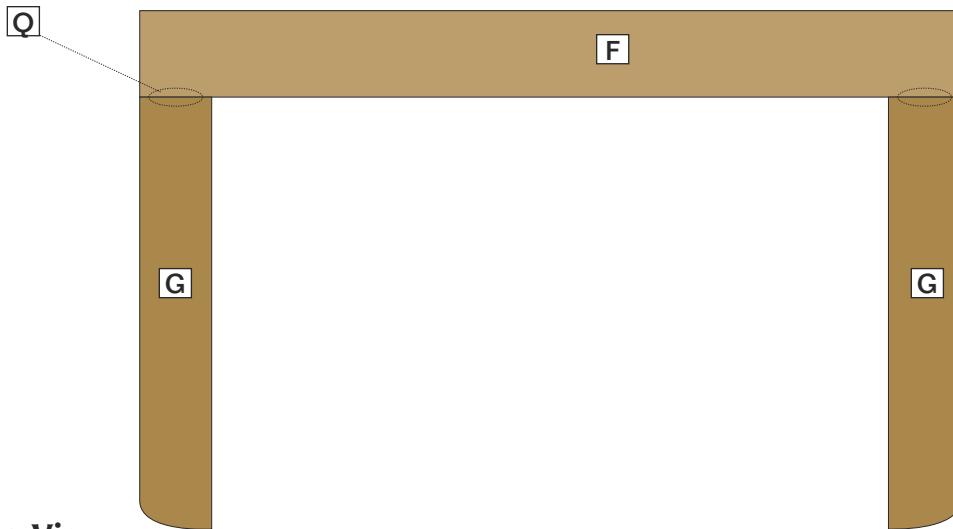

Lid Frame Top View



Cut Base Pieces

and face grain will be at the corners. In laying out the center line of the base pieces, add $\frac{3}{4}$ " to one end to compensate for the mating piece. After making the cutouts with a band saw or jig saw and sanding, use a $\frac{1}{4}$ " round-over router bit to roundover the edges of the cutouts. Save two of the cutout portions to use as braces for the lid.



Attach the Base

Step 20 - Cut the base corners (L) to the dimensions given in the material list. Mount the corners using the same techniques used in step 17, as shown in photo S.

Step 21 - Apply glue to the mating surface of the base, and insert the base into the bottom of the box until it meets the box floor.



Mount Braces on Lid

Drive screws through the base sides and into the box carcass, as shown in photo T.

Step 22 - Glue four $3\frac{1}{2}$ " boards together to make the lid (M). After the glue has been cured and the surfaces have been flattened and sanded, trim the lid to the final size. The front edge of the lid should have the same amount of overhang as the lid frame



Attach Piano Hinge

sides. Rout the front edge of the lid with a $\frac{1}{4}$ " router bit.

Step 23 - Use two of the cutouts from the base for lid braces. Glue and mount the braces on the lid bottom, as shown in photo U.

Step 24 - Cut the piano hinge (R) to the length given in the material list using a



Attach Lid to Box

hack saw, and attach the hinge to the lid, as shown in photo V.

Step 25 - Attach the lid to the box along the piano hinge, as shown in photo W.

Step 26 - Sand the box through 220-grit sandpaper. Apply your favorite finish (S).



Finish

We used DecoArt Americana Acrylic Satin Enamel in Tuscany Red and DecoArt Americana Water-based Stain in Chestnut. A DecoArt Americana Polyurethane Varnish in Satin was used over the stained portion, as shown in photo X. www