



Jewelry Box

Plan No. 906

Copyright U-Build, Inc., 2000.
All rights reserved. Printed in the U.S.A.

Even costume jewelry shines when it's housed in an elegant, handcrafted jewelry box. That's what makes this jewelry box project ideal for any collection. Made of maple for its beauty and durability, the box features a lock for security and a convenient lift-out tray.

Utilizing all straight cuts and simple joinery techniques, the jewelry box is a good project for beginners. Just cut the pieces to size, assemble, finish and install the hardware. The inside may be flocked or lined, or simply finished like the outside.

The completed jewelry box measures 13 inches wide by 10 inches deep by 5 inches tall.

Bill of Material

Quantity	Size	Material	Item
1	3/4" x 6" x 6'	Maple	A, B, D
1	3/8" x 6" x 6'	Maple	C, G, H, I, J, K
1	1/2" x 3/4" x 5'	Maple Molding	E, F
1 Pair	1 1/2"	Butt Hinges	
1		Small Box Lock	
1	Small Bottle	Wood Glue	
1	Pint	Finish	

Cutting Schedule

Part	Qty	T	W	L	Material
A	2	3/4"	4 1/4"	8 1/4"	Maple
B	2	3/4"	4 1/4"	12"	Maple
C	1	3/8"	7 1/2"	10 1/2"	Maple
D	1	3/4"	9"	12"	Maple
E	2	1/2"	3/4"	10"	Maple
F	2	1/2"	3/4"	13"	Maple
G	2	3/8"	1 3/4"	7"	Maple
H	2	3/8"	1 3/4"	10 3/8"	Maple
I	2	3/8"	6 5/8"	9 5/8"	Maple
J	1	3/8"	1 3/8"	6 5/8"	Maple
K	2	3/8"	1 1/2"	7 1/2"	Maple

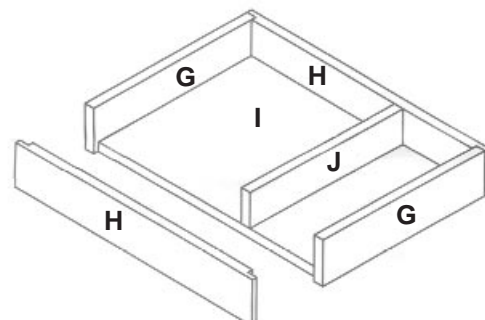
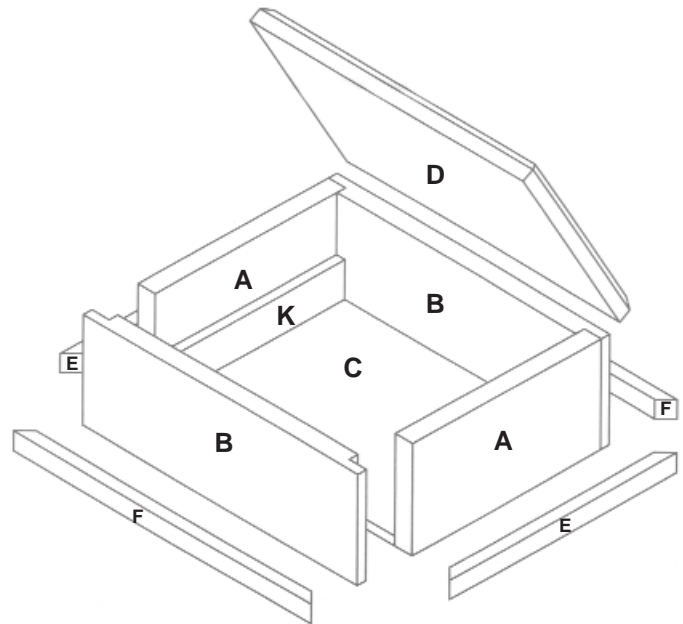

NOTES

1. Although maple is preferred for this project, other wood may be substituted.
2. You may add more partitions to or relocate board (J) in the removable tray.
3. Read manufacturer's instructions before operating equipment.
4. Always wear safety glasses.

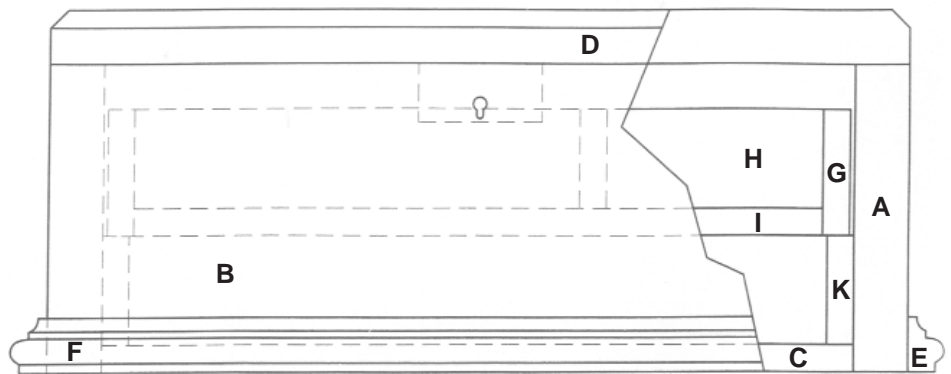
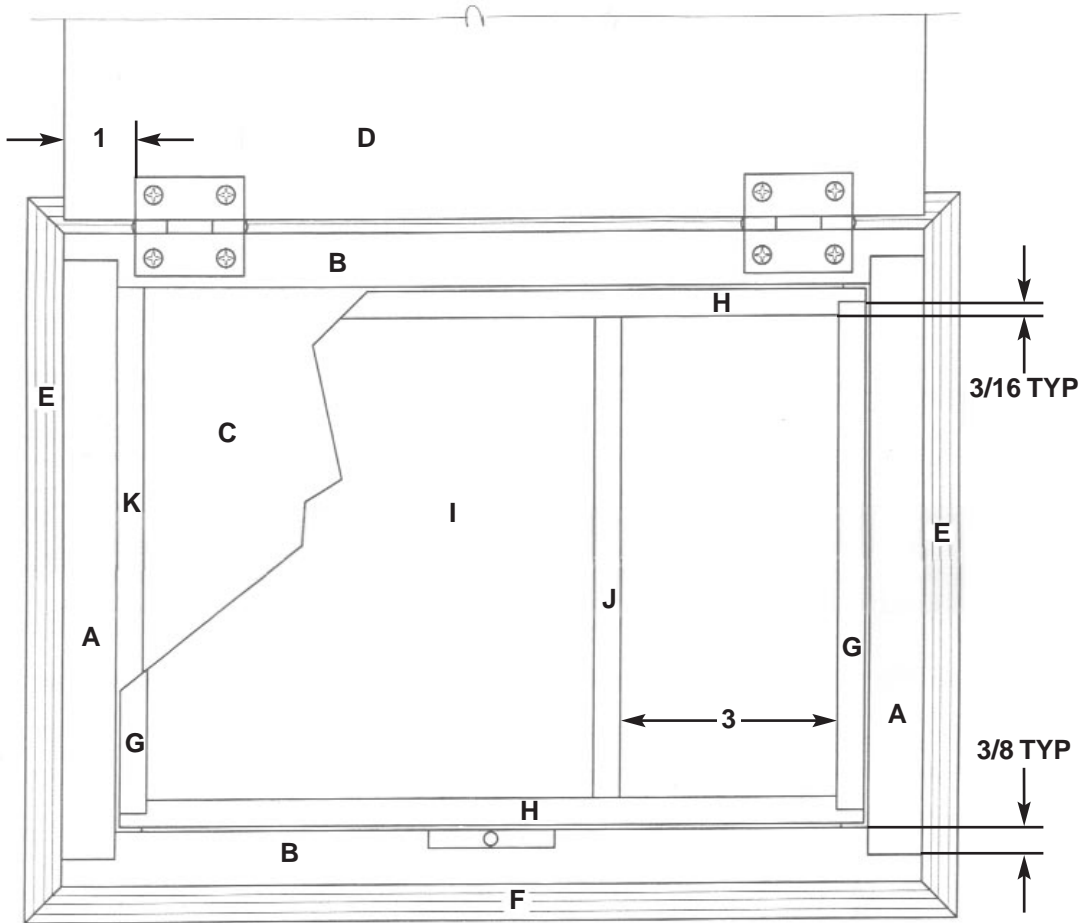

Assembly Instructions

1. Read all instructions before beginning any work.
2. Cut all material to sizes shown in cutting schedule. (This is a good time to cut out the area for installing a lock.)
3. Glue and clamp boards (B) to boards (A). Check assembly for squareness.
4. Glue the bottom of the box (C) to assembly (A, B).
5. Glue and clamp boards (G) to boards (H). Check assembly for squareness. Glue the bottom of the box (I) to assembly (G, H).
6. Install board (J) with glue to tray assembly. Cut tray supports (K) to fit box assembly.
7. Cut 45 degree miter on molding pieces (E) and (F) and glue to box.
8. Sand, apply finish and install hardware.