

18 WAYS TO BECOME A BETTER (AND SAFER) WOODWORKER

NOVEMBER 2007
ISSUE #165

POPULAR WOODWORKING

Learn How. Discover Why. Build Better.

Table Saw Shootout

We Test 6
Top Hybrids
& Find the Best

World-Class
Finish From a
Home Center

Sexy Results With
Common Materials

Workbench
Upgrades

11 Easy Ways to
Ease Your Work

Shaker Oval
Music Box
An Instant Heirloom



popularwoodworking.com

fw F+W PUBLICATIONS, INC. US \$5.99
CAN \$7.99

11

0 74470 01355 6

Display until November 13, 2007



Grizzly Industrial®

PURVEYORS OF FINE MACHINERY®, SINCE 1983!

THE 12" EXTREME SERIES TABLE SAW w/RIVING KNIFE!



This Extreme Table Saw is ideally suited to handling large panels and big jobs without blinking an eye. Front and rear mounted extension tables are included and support the widest panels before, during and after the cut. Ample storage shelves, a user friendly blade guard, a riving knife, a digital readout for blade angle and an efficient dust management system that includes an internal dust port. The left-tilting blade moves up and down, allowing the riving knife to remain at a constant height just under the blade.

AN INCREDIBLE SAW!

- Motor: 5 HP, 220V, single-phase
- Precision ground cast iron table
- Table size with extension: 30^{11/16}" x 78^{13/16}"
- Arbor size: 1" • Arbor speed: 3600 RPM
- Max. dado width: 1"
- Max. depth of cut: 4" @ 90°, 2^{3/4}" @ 45°
- Max. rip capacity: 52"
- 3/8" x 3/4" T-slots & miter gauge
- Cast iron trunnions
- Quick release steel splitter
- Digital readout for bevel angle
- Dimensions: 91"W x 93"D x 42^{1/2}"H
- Approx. shipping weight: 966 lbs.



EXTREME SERIES

G0605X

INTRODUCTORY PRICE

ONLY \$1995⁰⁰

\$169^{shipping}
ANYWHERE IN LOWER 48 STATES

G0606X
7^{1/2} HP,
3-Phase
also available

2 HP, 10" HYBRID CABINET SAW

- Motor: 2 HP, 110V/220V, single-phase
- Precision ground cast iron table
- Table size w/wings: 27" x 39^{1/2}"
- Arbor: 5/8" • Rip capacity: 30"
- Cutting capacity 3" @ 90°, 2^{1/8}" @ 45°
- Approx. shipping weight: 439 lbs.

TOTALLY ENCLOSED CABINET WITH 4" DUST PORT



INCLUDES SHOP FOX® ALUMA-CLASSIC™ FENCE & CAST IRON MITER GAUGE

G0478

ONLY \$725⁰⁰

\$89^{shipping}
ANYWHERE IN LOWER 48 STATES

10" TILTING ARBOR HEAVY-DUTY TABLE SAW

- Motor: 3 HP, 220V, single-phase
- Precision ground cast iron table w/ 2 cast iron extension wings
- Table size w/ wings attached: 27" x 40"
- Arbor: 5/8" (accepts dado blades up to 1^{3/16}")
- Cutting capacity: 8" left & 26" right of blade
- Approx. shipping weight: 420 lbs.



INCLUDES SHOP FOX® CLASSIC™ FENCE & CAST IRON MITER GAUGE

G1023S

ONLY \$975⁰⁰

\$89^{shipping}
ANYWHERE IN LOWER 48 STATES

10" LEFT-TILTING TABLE SAW W/CAST IRON ROUTER TABLE

- Motor: 3 HP, 220V, single-phase
- Precision ground cast iron table
- Table size (with 2 solid extension wings attached): 48" x 27"
- Arbor: 5/8" diameter (accepts dado blades up to 1^{3/16}")
- Cutting capacity: 8" left & 26" right
- Max. depth of cut @ 90°: 3"
- Max. depth of cut @ 45°: 2^{1/8}"
- Approx. shipping weight: 503 lbs.

ROUTER NOT INCLUDED



48" x 27" TABLE W/ WINGS

INCLUDES SHOP FOX® CLASSIC™ FENCE & CAST IRON MITER GAUGE

G1023SLW

ONLY \$1050⁰⁰

\$159^{shipping}
ANYWHERE IN LOWER 48 STATES

THE ULTIMATE 14" BANDSAW

MADE IN ISO 9001 FACTORY!

- Motor: 1 HP, 110V/220V, single-phase, TEFC
- Precision ground cast iron table
- Deluxe extruded aluminum fence
- Cutting capacity/throat: 13^{1/2}"
- Max. cutting height: 6"
- Blade size: 92^{1/2}" - 93^{1/2}" long (1/8" - 3/4" wide)
- 2 blade speeds: 1500 & 3200 FPM
- Approx. shipping weight: 198 lbs.

INCLUDES FENCE, MITER GAUGE, 3/8" BLADE & QUICK BLADE RELEASE SYSTEM



G0555

ONLY \$435⁰⁰

\$69^{shipping}
ANYWHERE IN LOWER 48 STATES

17" HEAVY-DUTY EXTREME SERIES BANDSAW

- Motor: 2 HP, 110V/220V, single-phase, TEFC, 1725 RPM
- Precision ground cast iron table
- Table size: 24" x 17" x 1^{1/2}"
- Max. cutting height: 12"
- Blade length: 131^{1/2}"
- Blade sizes: 1/8" - 1"
- Blade speeds: 1700 & 3500 FPM
- Dust port: (2) 4"
- Approx. shipping weight: 414 lbs.

INCLUDES 1/2" BLADE, FENCE & HEAVY-DUTY MITER GAUGE

MADE IN ISO 9001 FACTORY!

EXTREME SERIES



G0513X ONLY \$975⁰⁰

\$89^{shipping}
ANYWHERE IN LOWER 48 STATES

3 HP CYCLONE DUST COLLECTOR



55 GAL. STEEL COLLECTION DRUM

- Motor: 3 HP, 220V, single phase, TEFC Class "F"
- Amps: 19.5
- Cycle/RPM: 60 Hertz/ 3450 RPM
- Intake hole: 8"
- Impeller: 15" steel
- Suction capacity: 1654 CFM @ 2.0" SP
- Max. static pressure: 14.2"
- Filtration: 0.2-2 micron, 99.9% efficiency
- Filter surface area: 108 sq. ft.
- Approx. shipping weight: 421 lbs.



G0441 ONLY \$1195⁰⁰

H7509 STAND ONLY \$169⁹⁵

\$89^{shipping}
ANYWHERE IN LOWER 48 STATES

\$59^{shipping}
ANYWHERE IN LOWER 48 STATES

BELLINGHAM, WA • MUNCY, PA • SPRINGFIELD, MO

MEDIA CODE
POP0711

CUSTOMER SERVICE:
570-546-9663
FAX: 1-800-438-5901

1-800-523-4777



8590R

- A MILLION SQUARE FEET PACKED TO THE RAFTERS WITH MACHINERY & TOOLS
- 2 OVERSEAS QUALITY CONTROL OFFICES STAFFED WITH QUALIFIED GRIZZLY ENGINEERS
- HUGE PARTS FACILITY WITH OVER 1 MILLION PARTS IN STOCK AT ALL TIMES
- TRAINED SERVICE TECHNICIANS AT ALL 3 LOCATIONS
- MOST ORDERS SHIPPED THE SAME DAY
- 24 HOUR ORDERING BY PHONE OR ONLINE

FREE
GRIZZLY CATALOG
THOUSANDS OF
MACHINES, TOOLS &
ACCESSORIES!



NO DEALERS • NO MIDDLEMEN • BUY DIRECT & SAVE!

New!

6" PARALLELOGRAM JOINTER

- Motor: 1 HP, 110V, single-phase
- Precision ground cast iron table
- Table size: 6" x 55 1/2"
- Max. depth of cut: 1/8"
- Rabbeting capacity: 1/2"
- Cutterhead diameter: 3"
- Knife size: 6" x 3/4" x 1/8"
- Cutterhead speed: 4850 RPM
- Cuts per minute: 19,400
- 4" dust port
- Approx. shipping weight: 347 lbs.



4 KNIFE CUTTERHEAD
BUILT IN ADJUSTMENT ASSURES THAT TABLES ALWAYS REMAIN PARALLEL



G0604
INTRODUCTORY PRICE
ONLY \$525⁰⁰

\$89 ANYWHERE IN LOWER 48 STATES

BUILT-IN MOBILE BASE

1 1/2 HP SHAPER

- Motor: 1 1/2 HP, 110V/220V, single-phase
- Precision ground cast iron table
- Table size: 20 1/4" x 18"
- Spindle travel: 3"
- 2 interchangeable spindles: 1/2" & 3/4"
- Spindle openings on table: 1 1/4", 3 1/2" & 5"
- Spindle speeds: 7000 & 10,000 RPM
- Max. cutter diameter: 5"
- Approx. shipping weight: 221 lbs.

SHOWN W/ OPTIONAL G1706 WING

INCLUDES MITER GAUGE & FENCE WITH SAFETY GUARD & HOLD-DOWN SPRINGS



G1035 ONLY **\$515⁰⁰**

\$69 ANYWHERE IN LOWER 48 STATES

8" X 76" JOINTER

- Motor: 3 HP, 220V, single phase, TEFC
- Table size: 8" x 76 3/8"
- Infeed table size: 8" x 43 3/8"
- Cutterhead knives: 4 HSS, 8" x 3/4" x 1/8"
- Cutterhead speed: 5350 RPM
- Cuts per minute: 21,400
- Cutterhead diameter: 3 3/16"
- Max. depth of cut: 1/8"
- Max. rabbeting depth: 1/2"
- Approx. shipping weight: 597 lbs.

INCLUDES CAST IRON FENCE



BUILT-IN MOBILE BASE



PARALLELOGRAM TABLE ADJUSTMENT SYSTEM!

G0490 ONLY **\$795⁰⁰**

\$159 ANYWHERE IN LOWER 48 STATES

3 HP SHAPER

- Motor: 3 HP, 220V, single-phase w/ reversing switch
- Precision ground cast iron table
- Table size w/ standard wing attached: 30 1/2" x 28 1/4"
- 3 interchangeable spindles: 1/2", 3/4" & 1"
- Spindle travel: 3"
- Spindle openings on table: 1 3/8", 2 3/4", 4 & 5 1/2"
- Spindle speeds: 7000 & 10,000 RPM
- Approx. shipping weight: 357 lbs.

INCLUDES MITER GAUGE & FENCE WITH HOLD-DOWN SPRINGS

MAGNETIC SWITCH



G1026 ONLY **\$975⁰⁰**

\$89 ANYWHERE IN LOWER 48 STATES

12" x 83 1/2" PARALLELOGRAM JOINTER

- Motor: 3 HP, 220V, single-phase
- Precision ground cast iron table
- Table size: 12 3/4" x 83 1/2"
- Max. depth of cut: 1/8"
- Rabbeting capacity: 3/4"
- Cutterhead dia.: 3 3/4"
- Cutterhead speed: 4950 RPM
- Dust port: 5"
- Approx. shipping weight: 1036 lbs.

4 KNIFE CUTTERHEAD

New!



HANDLES FOLD IN FOR ADDED SAFETY

INTRODUCTORY PRICE
ONLY \$1595⁰⁰

\$225 ANYWHERE IN LOWER 48 STATES

18" OPEN END DRUM SANDER

- Motor: 1 1/2 HP, 110V, single-phase
- Drum surface speed: 4000 FPM
- Feed rate: variable, 2-12 FPM
- Max. stock size: 4 1/2" thick x 18" wide
- Min. board length: 6"
- Min. board thickness: 1/8"
- Drum size: 6"
- Conveyor belt size: 18" x 44 1/2"
- Approx. shipping weight: 350 lbs.

SANDS BOARDS UP TO 36" WIDE!



INDEPENDENT DUST COLLECTION W/ DUST BAG



G0458 ONLY **\$850⁰⁰**

\$89 ANYWHERE IN LOWER 48 STATES

15" PLANER/MOULDER

- Motor: 2 1/2 HP, 110V, single-phase
- Table size: 15" x 16"
- Max. cutting width: 15"
- Max. cutting height: 6"
- Min. stock thickness: 1/8"
- Min. stock length: 17"
- Max. cutting depth: 3/64"
- Feed rate: 11 FPM & 22 FPM
- Cutterhead dia.: 3 15/64"
- Cutterhead speed: 5500 RPM
- Approx. shipping weight: 181 lbs.

LIGHTWEIGHT & PORTABLE YET INCREDIBLY RUGGED!



G0477 ONLY **\$725⁰⁰**

\$69 ANYWHERE IN LOWER 48 STATES

15" PLANER

- Motor: 3 HP, 220V, single-phase
- Precision ground cast iron table size: 15" x 20"
- Max. cutting width: 15"
- Max. cutting height: 8"
- Min. stock thickness: 3/16"
- Min. stock length: 8"
- Max. cutting depth: 1/8"
- Feed rate: 16 FPM & 30 FPM
- Cutterhead dia.: 3"
- Knives: 3 HSS
- Cutterhead speed: 5000 RPM
- Approx. shipping weight: 675 lbs.

PRECISION GROUND CAST IRON BED & INFEEED OUTFEED TABLES!



BUILT-IN MOBILE BASE

G0453 ONLY **\$850⁰⁰**

\$159 ANYWHERE IN LOWER 48 STATES

20" PLANER

- Motor: 5 HP, 220V, single-phase
- Table size: 20" x 25 3/4" (20" x 55 5/8" w/ extension)
- Max. cutting width: 20"
- Max. cutting height: 8"
- Min. stock thickness: 3/16"
- Min. stock length: 7 1/2"
- Max. cutting depth: 1/8"
- Feed rate: 16 FPM & 20 FPM
- Cutterhead dia.: 3 1/8"
- Knives: 4 HSS
- Cutterhead speed: 5000 RPM
- Approx. shipping weight: 920 lbs.

PRECISION GROUND CAST IRON BED & INFEEED OUTFEED TABLES!



BUILT-IN MOBILE BASE

G0454 ONLY **\$1250⁰⁰**

\$169 ANYWHERE IN LOWER 48 STATES

OVER 12,000 PRODUCTS ONLINE!



grizzly.com



Introducing the new FEIN MULTIMASTER: the next generation of multi-purpose power tools.



AS SEEN ON TV!

**One tool, a few attachments...
Thousands of projects!**



NOW 40% more powerful!
The universal tool for renovation and remodeling is more powerful, versatile and ergonomically designed than ever. Replace windows, flooring, and tile; repair furniture, refinish molding; work on cars and boats and hobbies...the list is endless! A wide range of accessories are available.
MADE IN GERMANY



NEW QuickIN accessory changing! Now you can change any FEIN accessory quickly and easily...without tools!



NEW star arbor mounting system locks accessories tightly in place for increased productivity.



What's the difference? It oscillates. The MULTIMASTER oscillates for smooth running.



NEW!



NEW!



For more information or a dealer near you, call **1-800-441-9878** or visit us at **www.feinus.com**.

Look for the new FEIN informational commercial starring Jodi Marks and Pat Simpson of HGTV!

FEIN. Powered by innovation.





38 Hybrid Table Saws

Are hybrid saws the answer for the small shop, or are they a compromise? We test six premium models in a working shop to find the best.

BY TROY SEXTON

45 A Better Way to Work: Skills for Safety

WOODWORKING ESSENTIALS

Safety is not a set of rules, it's a way of working. This new manual will develop the skills you need to work accurately and safely.

BY MARC ADAMS

57 Upgrade Your Workbench

Eleven easy additions increase the capability of any workbench, allowing you to hold work of almost any size or thickness.

BY ROB PORCARO

62 Greene & Greene: A Mystery Table

Exactly who designed this library table (that was later cut down to make a coffee table) is unclear. But its lines and proportions are excellent.

BY DARRELL PEART

70 From Concept to Completion, Part 2

How to take your completed prototype into the shop and create the finished piece.

BY TED BROWN

74 Shaker Music Box

This simple project, based on a traditional oval box, makes an easy and wonderful gift.

BY JOHN WILSON



Number 165, November 2007. *Popular Woodworking* (ISSN 0884-8823, USPS 752-250) is published 7 times a year in February, April, June, August, October, November and December by F+W Publications, Inc. Editorial and advertising offices are located at 4700 E. Galbraith Road, Cincinnati, Ohio 45236; tel.: 513-531-2222. Unsolicited manuscripts, photographs and artwork should include ample postage on a self-addressed, stamped envelope (SASE); otherwise they will not be returned. Subscription rates: A year's subscription (7 issues) is \$19.96; outside of the U.S. add \$7/year • Canada Publications Mail Agreement No. 40025316. Canadian return address: 2835 Kew Drive, Windsor, ON N8T 3B7 • Copyright 2007 by *Popular Woodworking*. Periodicals postage paid at Cincinnati, Ohio, and additional mailing offices. Postmaster: Send all address changes to *Popular Woodworking*, P.O. Box 420235, Palm Coast, FL 32142-0235. Canada GST Reg. #R122594716 • Produced and printed in the U.S.A.

This \$15,000 DREAM



Enter for your chance to win a complete shop that features all you see here.

**ENTER
ONLINE
TODAY!**

popwood.com/winshop

Entry Deadline: Midnight, Eastern Standard Time, April 30, 2008

(Complete prizes and contest rules are also available at www.popwood.com/winshop)



The All-Star Workshop Giveaway is sponsored by:



TEAM could be yours!

BACK BY POPULAR DEMAND!



37-350A



36-L31X-BC50



GR450



35-7640



17-959L



22-580



28-475X

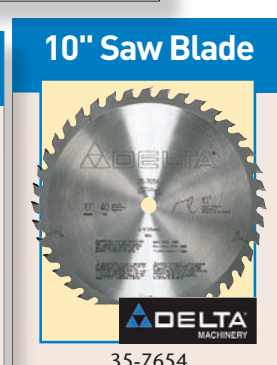

35-7654



Polyurethane Glue



HiPURformer™
Advanced Bonding System



Molding & Trim Glue



Titebond Original



Titebond III
Ultimate Wood Glue

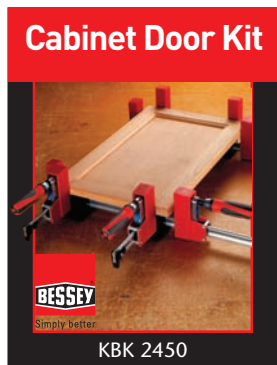

KBK 2450



BTB30A

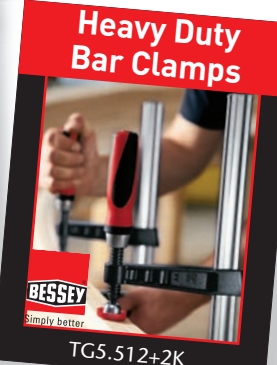

TG5.512+2K

POPULAR WOODWORKING'S "ALL-STAR WORKSHOP GIVE-AWAY" SWEEPSTAKES These are only abbreviated rules. The "All-Star Workshop Giveaway" Sweepstakes is subject to Official Rules available during promotion period (8/20/07 - 4/30/08) at www.popwood.com/winshop. See Official Rules for complete entry details and prize descriptions. **NO PURCHASE OR SUBSCRIPTION NECESSARY TO ENTER OR WIN.** Must be legal resident of the U.S. or Canada (excluding Quebec) who has reached the age of majority in the participant's jurisdiction of residence to enter. One Grand Prize—Woodworker's Home Workshop valued at US\$15,000. Odds of winning depend on number of entries. Void in Quebec and where prohibited. Sponsor: F+W Publications, Inc., 4700 E. Galbraith Road, Cincinnati, OH 45236 USA

popwood.com/winshop



12 It's Almost Always User Error
OUT ON A LIMB
BY CHRISTOPHER SCHWARZ

14 Horns on Doors
LETTERS
FROM OUR READERS

20 Versatile Assembly Bench
TRICKS OF THE TRADE
FROM OUR READERS

26 Period Details
ARTS & MYSTERIES
BY ADAM CHERUBINI

30 13" Ridgid Planer
TOOL TEST
BY OUR STAFF

36 Shaker Step Stool
I CAN DO THAT
BY MEGAN FITZPATRICK

80 Great Work from A Small Shop
GREAT WOODSHOPS
BY GLEN HUEY

86 Bench Hook
JIG JOURNAL
BY CHRISTOPHER SCHWARZ

96 Home Center Finishing
FLEXNER ON FINISHING
BY BOB FLEXNER

100 Project no. 3—er, Project no. 4
OUT OF THE WOODWORK
BY CHRIS HEDGES

ON THE NOVEMBER COVER



Hybrid table saws look like a cabinet saw but have the heart of a contractor's saw. Is this style of hybrid machine a good cross or will it just make you cross? Page 38.

COVER PHOTO BY AL PARRISH



It's all in the details



BOSTITCH® 23 Gauge Pin Nailer Kit

- Adjustable high/low power control sets pin depth without changing compressor settings
- Low profile nosepiece tapers down to contact point for a clear line-of-site
- Increased pin capacity accepts a wider range of fasteners (1/2" to 1-3/16" in length)
- Ultra quiet rear exhaust directs air away from user



CIRCLE #108 ON FREE INFORMATION CARD.

www.bostitch.com

STANLEY

BOSTITCH®



Video



Blogs

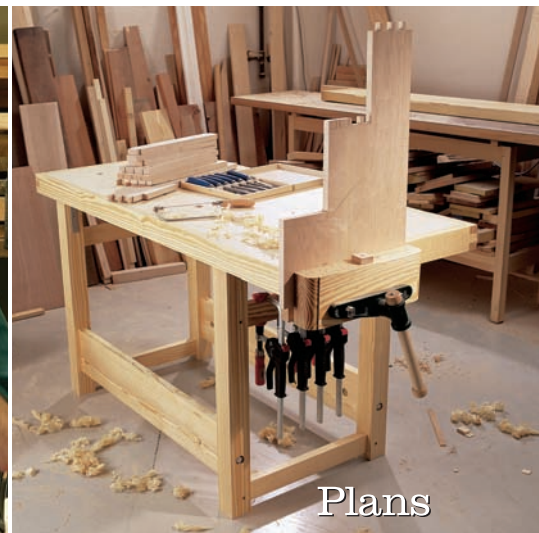

Plans

Video Gallery

Hybrid Saw Features

Join us as we take a look at our likes and gripes of the six table saws tested in this issue.

Holding Wide Boards

Rob Porcaro, author of "Upgrade Your Workbench," demonstrates the use of some of his unique workholding solutions. You'll find these free videos online at popularwoodworking.com/video

popularwoodworking.com

- [Contact Customer Service](http://popularwoodworking.com/customerservice)
- [Free Project Plans](http://popularwoodworking.com/projectplans)
- [Article Index](http://popularwoodworking.com/articleindex)
- [Tool Reviews](http://popularwoodworking.com/toolreviews)
- [Magazine Extras](http://popularwoodworking.com/magazineextras)
- [Editor Blogs](http://popularwoodworking.com/blogs)
- [Writer's Guidelines](http://popularwoodworking.com/writersguidelines)
- [Contact the Staff](http://popularwoodworking.com/contactus)

On the Blogs

PW Editors Blog

Exclusive tool reviews, the latest news, works in progress and more. Find out what we're up to between issues.

popularwoodworking.com/blogs

Woodworking Blog

Editor Christopher Schwarz maintains a blog for our sister publication, *Woodworking Magazine*.

woodworking-magazine.com/blog

Online Extras

Greene & Greene Table

Additional text, drawings and step photos for making the router jigs shown in the article, building the finger-joined drawers, shaping the handle and cutting and fitting the ebony plugs are available in pdf format. In addition, there is a slide show of detail photographs from the original table.

popularwoodworking.com/nov07

Home Center Finishing

We've expanded the finishing section of our web site even more this month, including half a dozen new articles from Bob Flexner.

popularwoodworking.com/nov07

Project Plans

Martha's Vineyard Cupboard

This hanging wall cabinet with two doors is a perennial favorite with readers.

popularwoodworking.com/projectplans

24-hour Workbench

You can have a rock-solid bench for less than \$200 in materials and just 24 hours of working time in the shop.

popularwoodworking.com/projectplans

Master the Mortise & Tenon

Frank Klausz shows three ways to create this traditional joint and make a small stool.

popularwoodworking.com/projectplans

And More!

Visit popularwoodworking.com/nov07 to find a complete list of all the online resources for this issue – including videos, additional drawings and photos.





"VERSATILE"



DO MORE, MORE ACCURATELY

A drill press is no longer just a drill press thanks to the robust features incorporated into the POWERMATIC PM2800 Variable Speed 18" Drill Press. Do more with a digital readout for accurate speed setting, two lasers in an X-Y axis to pinpoint the drilling center point, an extra large cast iron table with sliding extension wings, variable speeds from 300 to 3000, as well as a 5/8" keyless drill chuck for quick bit changes. Find more about the PM2800 at a local POWERMATIC dealer or at www.powermatic.com/pw



SELECTED
**HOT
NEW
TOOL**
for 2007
by
WOOD Magazine



DIGITAL
READOUT



LASER GUIDE
SYSTEM



5/8" KEYLESS
DRILL CHUCK



EXTENSION
WINGS

©2006 WMH TOOL GROUP, INC. The color GOLD is a registered trademark of WMH Tool Group, Inc.

Marc Adams has been a professional woodworker for almost three decades, during which he's won numerous awards, worked with the U.S. government on woodworking-related issues, and been featured in several books and many magazines. Fourteen years ago, Marc was the sole instructor when he opened the Marc Adams School of Woodworking in Franklin, Ind., to 160 students. Now, every year more than 2,500 students choose from almost 100 classes, all taught by world-renowned instructors. Needless to say, with so many people using the facility Marc is concerned with safety and accuracy. He shares his rules and procedures for achieving both in a new seven-part series.



Darrell Peart began his woodworking career making small wooden items to sell at Seattle's Pike Place Market, and worked for many years in various high-end custom shops throughout the Puget Sound, Wash., region. In 1989, he discovered the American Arts & Crafts movement and was captivated by the work of Charles and Henry Greene. His first book, "Greene and Greene: Design Elements for the Workshop" (Linden), was published in 2006.



Chris Hedges A former college sociology instructor, Chris decided to leave academia and recently completed a two-year furniture-making program at the University of Rio Grande in south central Ohio. The fourth woodworking project he's ever built, a near-flawless Philadelphia-style secretary, won the "Best of Show" award in the Fresh Wood competition at the 2007 Association of Woodworking & Furnishings Suppliers show (AWFS). He now plans to build furniture full time.



Rob Porcaro has been a woodworker for more than 25 years. You can see his work online at rpwoodwork.com. Rob is a doctor of optometry by day and a master's track competitive sprinter. He lives in Medfield, Mass., with his wife, Julie; son, Mark; and daughter, Stefanie. In this issue, he writes about workbench upgrades on page 57.

Troy Sexton A long-time professional cabinetmaker, Troy is in the middle of rearranging his shop in Sunbury, Ohio. He says he's going to get rid of one of his five (five!) table saws and replace that with a panel-saw system. But before he does that, Troy has more pressing business: A trip to Canada to fish for pike and walleye.

PUBLISHER & GROUP EDITORIAL DIRECTOR
Steve Shanesy

EDITOR Christopher Schwarz
x1407 ■ chris.schwarz@fwpubs.com

ART DIRECTOR Linda Watts
x1396 ■ linda.watts@fwpubs.com

SENIOR EDITOR Robert W. Lang
x1327 ■ robert.lang@fwpubs.com

SENIOR EDITOR Glen D. Huey
x1293 ■ glen.huey@fwpubs.com

MANAGING EDITOR Megan Fitzpatrick
x1348 ■ megan.fitzpatrick@fwpubs.com

PHOTOGRAPHER Al Parrish

CONTRIBUTING EDITORS
Adam Cherubini, Bob Flexner, Troy Sexton

F+W PUBLICATIONS INC.

CHAIRMAN & CEO David H. Steward

CFO John Speridakos

EXECUTIVE VP, INTERACTIVE MEDIA John Lerner

VP, MANUFACTURING Barbara Schmitz

DIRECTOR, IT Mike Kuehn

F+W PUBLICATIONS INC.
MAGAZINE GROUP

PRESIDENT Colin Ungaro

VP, CONSUMER MARKETING Sara DeCarlo

BUSINESS PLANNING DIRECTOR Tom Wiandt

CONFERENCE DIRECTOR Sara Dumford

CIRCULATION DIRECTOR Linda Engel

NEWSSTAND DIRECTOR Susan Rose

DIRECTOR, DIGITAL MEDIA SOLUTIONS Michael Kushner

PRODUCTION

PRODUCTION MANAGER Vicki Whitford

PRODUCTION COORDINATOR Katherine Seal

ADVERTISING

ADVERTISING DIRECTOR Don Schroder

331 N. Arch St., Allentown, PA 18104

TEL. 610-821-4425; FAX 610-821-7884

d.schroder@verizon.net

ADVERTISING PRODUCTION COORDINATOR

Nancy Miller, 513-531-2690 x1228

nancy.miller@fwpubs.com

SUBSCRIPTION SERVICES: Subscription inquiries, orders and address changes can be made at popularwoodworking.com (click on "Customer Service"). Or by mail: *Popular Woodworking*, P.O. Box 420235, Palm Coast, FL 32142-0235. Or call toll-free 877-860-9140 or 386-246-3369. Include your address with all inquiries. Allow 6 to 8 weeks for delivery.

NEWSSTAND DISTRIBUTION: Curtis Circulation Co., 730 River Road, New Milford, NJ 07646

ATTENTION RETAILERS: To carry *Popular Woodworking* in your store, call 800-894-4656 or write Magazine Retail Sales, P.O. Box 5014, Iola, WI 54945-5014.

BACK ISSUES are available. Call 800-258-0929 for pricing or visit popularwoodworking.com. Send check or money order to: *Popular Woodworking* Back Issues, F+W Publications Products, 700 E. State St., Iola, WI 54990. Please specify publication, month and year.



What's The Secret To Flawless Edge Profiles With NO REWORK?

Quadra-Cut™

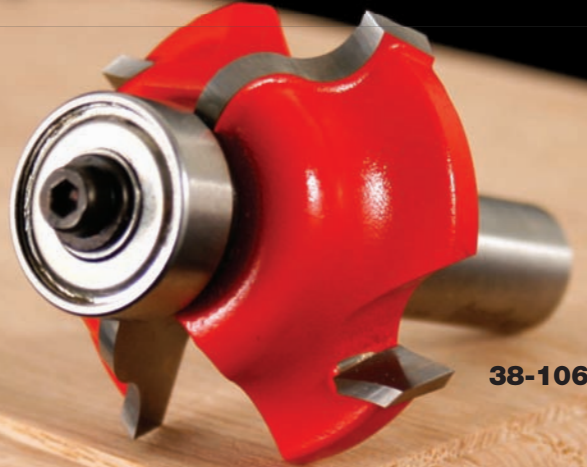

38-106

Freud's New Quadra-Cut™ 4 Cutter Design



How It Works!

Two large cutter wings shear upward to remove most of the stock for fast, extremely smooth cuts.

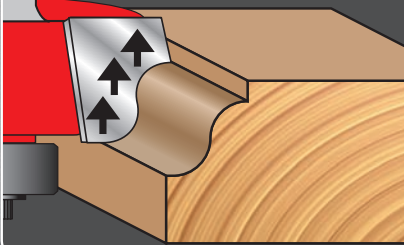

Two small cutter wings shear downward for an ultra-fine finish, even when routing crossgrain in delicate materials!

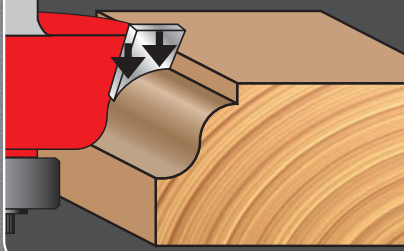

U.S. Patent No. 8,899,252

For A Smooth Sanded Finish...

...Without The Rework!

Freud's Exclusive 4 Cutter Design

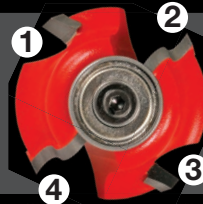

All Other Router Bit 2 Cutter Design



"Mirror-smooth finish with sharp, clean details!"

— Chris Marshall, *Woodworker's Journal*

"Super-smooth cuts!"

— Glen Huey, *Popular Woodworking*

Look For These Popular Profiles in 1/2" Shank Quadra-Cut™ Design:

- Classical Cove & Round Bit
- Rounding Over Bit, 3/8" Radius
- Rounding Over Bit, 1/2" Radius
- Rounding Over Bit, 1" Radius
- Beading Bit, 5/16" Radius
- Beading Bit, 1-1/8" Radius
- Table Top Classical Bold Bit
- Table Edge Bit
- Rounding Over Bit, 5/8" Radius
- Rounding Over Bit, 1-1/2" Radius
- Raised Panel Bits



freud[®]
Precisely the best

To sign up for Freud's e-mail newsletter or to find a dealer near you visit: www.freudtools.com

Red router bits are a registered trademark of Freud America, Inc. (US) 7-800-472-7307

CIRCLE #119 ON FREE INFORMATION CARD.

It's Almost Always User Error

So I have the assembled carcass of a sideboard braced against my workbench and I'm planing the top edge of the aprons flush with the top of the legs.

After 10 strokes, things go all wrong.

The front apron of the sideboard comes loose, and the carcass sways like a drunken sailor on my shop floor. At first I can't bear to look at the problem (like when you cut yourself) but then I examine the damage.

The Festool Domino I installed in the apron have come loose from the leg. Now, the natural thing to do is to blame the newfangled tool that I'm testing. But I can't.

While the Festool Domino is an engineering wonder, so is the machine that injects cream filling into a Twinkie. It's not the technology that's the problem; it's how the technology gets used that determines if it's a sensation or a scourge. Too many of our tools, books and magazines encourage us to take shortcuts. We get excited when anything seems easy, fast or inexpensive.

It's human nature, and I fell for it.

I had ignored the basic rules for sizing mortise-and-tenon joints. Specifically, that your tenon's width needs to be two-thirds the width of your stock. Because the Dominos fit so perfectly in the holes, I beguiled myself into using two of them in each leg—I really needed three.

I can remember the same giddy sensation I got when I first used a biscuit joiner (with a similar stupid error). And the time when I became enamored with my router-

powered dovetail jig. I thought I'd be making everything with dovetails. And it would be so fast. And easy. And cheaper than buying the tools to cut them by hand.

It took three agonizing days of work to make my first drawer with that jig. Let me be clear about one thing: There's nothing wrong with dovetail jigs, it's just that some of them are better suited for producing drawers for an

entire kitchen (or subdivision). Making one custom drawer with a jig like that is not so smart.

Frustrated with my sideboard, I trudged upstairs and picked up Charles Hayward's "Woodwork Joints." This out-of-print book is filled with drawings of how traditional cab-

inets are supposed to be built. And it isn't a simple, fast or easy process. Good furniture is a lot of work.

I looked up Hayward's rules for sizing tenons, then returned to the shop. I disassembled my undersized joints and used the ultra-modern Domino to cut joints that obeyed the rules that were laid down long before I was born. I reassembled the carcass and braced it against my bench to complete the operation that destroyed my first attempt.

After 10 strokes, I knew I'd done the right thing. Then I vowed to write this experience down so I wouldn't forget it. And so here is, a note to myself. **PW**



Christopher Schwarz

Customer Service

How can I contact customer service with questions regarding my subscription, including a lost or damaged issue? Visit popularwoodworking.com/customerservice. Or write to *Popular Woodworking*, P.O. Box 420235, Palm Coast, FL 32142-0235. Or, if you prefer the telephone, call toll-free 877-860-9140 and a customer service representative will be happy to help you.

When does my subscription expire?

The date of your subscription expiration appears on your magazine mailing label, above your name. The date indicates the last issue in your subscription.

Can I get back issues of Popular Woodworking?

Back issues are available while supplies last. Visit popularwoodworking.com/backissues. Or if you know the exact month and year of the issue you want, call our customer service department toll-free at 800-258-0929 to order.

What if I want more information about the projects and tools I read about in Popular Woodworking?

For all editorial questions, please write to Popular Woodworking Editorial, 4700 E. Galbraith Road, Cincinnati, OH 45236. Or e-mail popwood@fwpubs.com.

Does Popular Woodworking offer group discounts?

Group discounts are available by special arrangement with the publisher. For more details, send an e-mail to debbie.paolello@fwpubs.com or call 513-531-2690 x1296.

Our Privacy Promise to You

We make portions of our customer list available to carefully screened companies that offer products and services we believe you may enjoy. If you do not want to receive offers and/or information, please let us know by contacting us at:

List Manager, F+W Publications
4700 E. Galbraith Road
Cincinnati, OH 45236

Safety Note

Safety is your responsibility. Manufacturers place safety devices on their equipment for a reason. In many photos you see in *Popular Woodworking*, these have been removed to provide clarity. In some cases we'll use an awkward body position so you can better see what's being demonstrated. Don't copy us. Think about each procedure you're going to perform beforehand.



INNOVATIVE PRODUCTS DESIGNED FOR PRACTICAL USE

New

with Variable Speed



W1739

MINI PLANER/MOULDER

2 HP, single-phase, 220V motor
Variable Speed motor: 0.8 HP
Cutterhead speed: 7000 RPM
Feed rate: 1-18 FPM
Max. profile depth: 3/4" Max. profile width: 6 3/4"
Planing width: 7" Min. stock length: 9"
Min. stock thickness: 1/4"
Max. stock thickness: 7 1/2"
Approx. shipping weight: 240 lbs.

Easy access cutterhead for trouble free blade changes.

W1707 17" BANDSAW

2 HP, 220V, single-phase TEFC motor
Precision ground cast iron table
Table size: 17 1/2" x 23 1/4"
Cutting capacity/throat: 16 1/4"

Max. cutting height: 12"
Table tilt: 15° L, 45° R
Blade size: 132" long
(1/8" - 1" wide)
Blade speeds: 1600 & 3300 RPM
Approx. shipping weight: 409 lbs.



Quick Change Blade Release/Tensioning

Includes 1/2" Blade, Fence & Miter Gauge



Includes Shop Fox® Classic Fence, motor cover & dust port

W1677

10" LEFT-TILT CABINET TABLE SAW

3 HP, single-phase, 220V motor
Precision ground cast iron table with T-slots
Table size: 27" x 40 1/8" (with wings)
Heavy-duty cast iron miter gauge
Arbor: 5/8" (accepts up to 1 3/8" Dado sets)
Max. blade height: 3"
Ripping capacity w/ standard rails: 26"
Approx. shipping weight: 474 lbs.

W1742

15" PLANER w/ CAST IRON WINGS & MOBILE BASE

3 HP, 220V, single-phase motor
Table size: 15" x 20"
Max. cutting height: 8"
Min. stock thickness: 3/16"
Min. stock length: 8"
Max. cutting depth: 1/8"
Cutterhead dia.: 3"
Cutterhead knives: 3 HSS
Cutterhead speed: 5000 RPM
Feed rate: 16 FPM & 30 FPM
Approx. shipping weight: 675 lbs.

Internal Magnetic Safety Switch w/Thermal Overload Protection

New



W1689

15" OPEN END WIDE-BELT SANDER

5 HP, 220V, single-phase sanding motor
Sanding motor speed: 1725 RPM
1/4 HP feed motor
Belt speed: 2050 FPM
Max. sanding width: 15" x 2"
Max. stock thickness: 5 1/2"
Min. stock size: 12" long x 1/8" thick

Made in ISO 9001 Factory

Belt size: 16" x 48"
Dust port: 5"
Height: 62"
Approx. shipping weight: 914 lbs.

*Sliding Support Bar
Pneumatic Belt Tensioning, Tracking & Oscillation*

30" Sanding Capacity!



W1741

8" JOINTER w/PARALLELOGRAM ADJUSTABLE BEDS

3 HP, 220V, single-phase, TEFC, 3450 RPM motor
Precision ground cast iron parallelogram design tables
Table size: 8" x 76 3/16" Infeed table size: 8" x 43 3/8"
Deluxe cast iron fence size: 35"L x 1 1/4"W x 5"H
Cutterhead diameter: 3 3/8"
Cutterhead knives: 4HSS
Cutterhead speed: 5350 RPM
Max. rabbeting depth: 5/8"
Max. depth of cut: 1/8" Max. width of cut: 8"
Approx. shipping weight: 600 lbs.

New



Built-in Locking Mobile Base

SHOPFOX.BIZ



1-800-840-8420

SHOP FOX® is a registered trademark of Woodstock International, Inc.

TO SEE OUR INNOVATIVE MACHINES AT AN AUTHORIZED DEALER, PLEASE CALL FOR THE LOCATION NEAREST YOU! sales@shopfox.biz

CIRCLE #165 ON FREE INFORMATION CARD.

Horns on Doors Help Eradicate Blowout

I have been reading in your blogs (popularwoodworking.com/blogs and woodworking-magazine.com/blog) and elsewhere about mortising by hand. I have noticed that the stiles of your assemblies have been left long so they do not blow out during hand mortising. My question is: What is the best way to trim the long stiles when it comes to fitting the door? Would you cut them with a handsaw and plane up to the rail, or try it on the table saw, cutting from each side?

— John Borgwardt, Eau Claire, Wisconsin

The extra-long stiles are called “horns.” They’re removed after assembly. The traditional way to remove them is with a fine crosscut backsaw. You press the saw plate against the adjoining rail then trim the horn flush.

Then you fit the door to its opening with a plane, which should remove any additional ragging or tearing on the ends.

You also can de-horn the door on a table saw with a sliding table or miter gauge with a fence. I’ll do this as part of my typical regimen of squaring a door (or any other panel) after assembly.

— Christopher Schwarz, editor

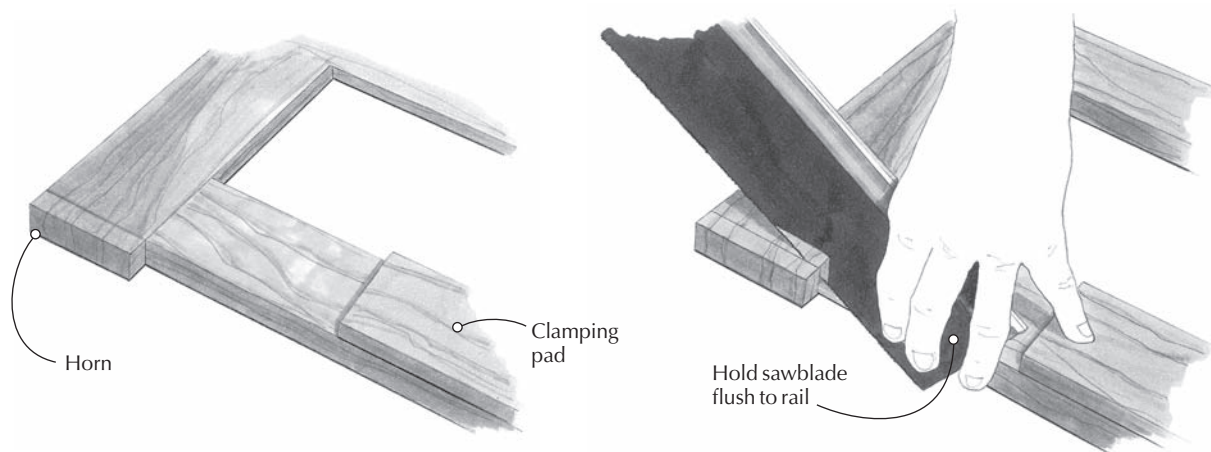

Eradicating Odors in Wood

I recently “rescued” my late grandfather’s Euro-style woodworking bench from my brother’s basement where it was stored unused for 30 years. I suspect it is 100 years old or more.

My grandfather was quite a wood craftsman, and I fully suspect he made the bench around 1900, shortly after immigrating to the United States from Poland. He spent his career as a woodworker in the furniture factories of Grand Rapids, Mich.

The bench appears to be made of very hard maple and is heavier than I expected. I added casters to get it around my garage.

I have a few questions. First, how can I reduce or get rid of its musty basement smell? And, because the bench is covered

with various paint and glue spatters and other assorted oily stains, should I try to use paint remover or something else on it?

The top surface is gently used and is not as true as my assembly table that has a replaceable plastic laminate top, but I’d still be delighted to use the bench to make gifts for my grandchildren and eventually hand it over to another family woodworker.

— Don Golembiewski, Spring Green, Wisconsin

I’ve had good luck cleaning old furniture (inherited from an old maiden aunt with four cats) by scrubbing it with a solution of trisodium phosphate and rinsing with clear water. Wear rubber gloves and work outside. This is effective at

removing grime and odors and will often loosen paint spatters. There’s a good chance this will raise the grain in the wood and make it rough, so be prepared to go over all the surfaces with a Scotch-Brite pad after it is dry. Globes of glue and stubborn paint spots can be removed by carefully scraping them with a sharp chisel.

Your next steps depend on how nice you want it to look, and if you want to flatten the top. You could sand the whole thing down to bare wood, but you would lose the patina it’s developed. I would clean it up, remove any paint or glue that is on the surface and plane the top flat. A coat of Danish oil will help the appearance and provide some protection.

— Robert W. Lang, senior editor

CONTINUED ON PAGE 16

Woodpeckers

SUPER FENCE

The Next Generation Router Table Fence.

Made in U.S.A.

Woodpeckers Inc.
www.woodpeck.com
800-752-0725

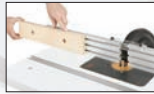

3 7/8" Height, 36" Length.



Clamps.



Toolless Offset.

CIRCLE #164 ON FREE INFORMATION CARD.

Make your own Custom coves

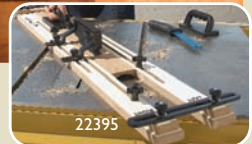

Make your projects stand out from the crowd with huge custom coves! Our easy-to-use **Cove Cutting Jig** accepts stock up to 7" wide and 1 1/2" thick, yielding large, swooping curves that truly serve as your "crowning touch." Only \$79.99!

For countless other great products like this, visit www.rockler.com, stop by one of our stores nationwide, or request our **FREE** catalog.



ROCKLER
WOODWORKING AND HARDWARE
Create with Confidence™

Code: 811

For a **FREE** catalog, visit www.rockler.com or call 1-800-403-9736. Stores Nationwide

CIRCLE #152 ON FREE INFORMATION CARD.



Marc Adams School of Woodworking is committed to fine woodworking excellence through hands-on learning experiences with the best woodworkers of modern time.

- ▣ Diverse curriculum
- ▣ 50 world-class instructors
- ▣ Short-term, intensive classes

Check out 2008 workshops online
www.marcadams.com
317-535-4013

CIRCLE #134 ON FREE INFORMATION CARD.

ARE YOU READY FOR THIS?



Check all that apply:

- I have a collection of old dull drill bits I just can't throw away.
- I'd rather spend my money on new tools than on buying more drill bits.
- I know I should sharpen my drill bits, but I don't have time to become a sharpening expert.
- I want to drill clean, precise holes every time.
- I'm tired of searching through all of my used bits trying to find one sharp enough to use.

If you checked any of these, you're ready to sharpen your drill bits with Drill Doctor, THE Drill Bit Sharpener. See it in action online at

www.drilldoctor.com

1-888-MYDRILL (693-7455)

OVER
2
MILLION
SOLD

Drill Doctor
The Drill Bit Sharpener

FULL
3
YEAR
WARRANTY

Look for the Drill Doctor at Sears, The Home Depot, Lowes, Northern Tool, and wherever you buy your tools.

CIRCLE #112 ON FREE INFORMATION CARD.

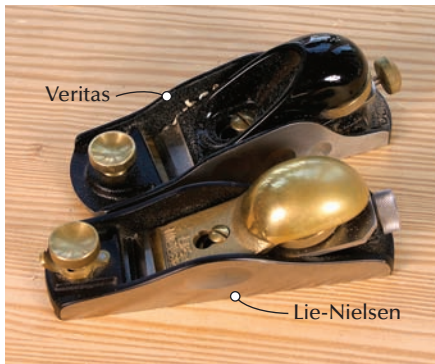

Block-plane Purchase Advice

I am considering purchasing a low-angle block plane for use in trimming hand-cut dovetails and for some rank cuts. What is your opinion as to which is the best to buy: one with a lateral-adjustment lever for the blade or one without that feature? (I am looking at the Veritas, with lateral adjustment versus the Lie-Nielsen, without the lateral adjustment.)

— Don Putman, via e-mail

Believe it or not, I think lateral-adjustment mechanisms in block planes are mostly a non-issue. All block planes can be laterally adjusted using small hammer taps or finger pressure. In fact, I find that I'll adjust the iron this way even if it has a lateral-adjust lever because it's a finer, more sensitive way to accomplish the task.

So bottom line, you can't lose with either plane on your list. Both are high-quality tools that will last several lifetimes and will not disappoint you in the function department.

— Christopher Schwarz, editor

Pen Finish Advice: Wax On

I have been turning a lot of pens, for which I want your finishing recommendations. I go from plain paste wax to a mixture of turpentine, shellac and boiled linseed oil.

— Greg Just, Blaine, Minnesota

I'm not so sure about your combination of wax, shellac and oil. I'm not a chemist, but I just wonder how compatible all that different material is — wax, alcohol in shellac, and oil? Generally, I'd stay away from film-forming finishes on pens because it will wear through if the pen is used regularly. I like the idea of wax and oils. It brings up the wood color and will combine with the oil in one's hands after use, and that will tend to enhance the patina. Because you can buff at high speed right on the lathe, it's easy to bring up the luster. Another thought is using hard stick wax

(HUT wax is one brand). This actually offers more protection than the softer paste wax and can be brought up to a good shine when buffed at high speed. You actually need the speed to generate some heat from friction to work with the hard wax. It is especially good on extra-hard woods after sanding the piece to #400 grit minimum or #600 grit, and sometimes higher if you want.

Don't forget the old burnishing trick, too. Grab a handful of shavings in the palm of your hand and rub the work while it's turning on the lathe. Do this before any finishing.

— Steve Shanesy, publisher

Do Diamond and Waterstones Mix?

I read about using diamond stones to flatten waterstones, but was concerned that even a diamond stone would start to wear hollow at some time. I know diamond stones don't last forever, so do I need to worry about their flatness during their lifetime? Am I wrong or are these stones different in some way?

— Mike Lingenfelter, Bothell, Washington

I've used diamond stones to flatten waterstones for many years without any problems with them dishing or wearing out prematurely. And while there is a school of thought that insists on getting waterstones as flat as a machinist's granite surface plate, I'm not a student of that school.

You just need to remove any hollow in the waterstone to get consistent results. If the entire surface of the stone is a little convex or concave along its length, you won't have any problems.

That said, there is one area of concern when using diamond stones to flatten a waterstone. And that's the grit of diamond stone you use. You need to use one of the coarser grits (60 micron or 45 micron — the black or the blue in DMT's color scheme). The finer-grit diamond stones will self-destruct if used to flatten waterstones.

— Christopher Schwarz, editor

Bedeving Compressor Moisture

I'm having a lot of trouble with moisture in my 25-gallon, 175PSI two-stage air compressor. I know that no matter what, I'll get moisture in the tank. The problem is that I'll empty the tank after closing up shop, shut it down, then first thing in the morning turn it on and have to drain it again. I have a filter and air dryer (that I have to replace every other week) all connected and everything seems to be working properly. My question: Is this moisture problem due to

high humidity (thanks to living on the Mississippi coast) or is there something I can do to stop or reduce this problem?

— James Swisher, Biloxi, Mississippi

You're better off with the moisture ending up in the tank than in your air lines. This is a result of moisture in the humid air condensing as the compressor operates. There are a couple things you can do with the way you run the air lines to help, but all these methods will do is give the water a place to go.

The first thing is to make sure that all the lines run slightly uphill from the compressor, letting the water run back to the tank where you can drain it.

The second thing is to install some drops with drain valves at or near the air outlets. All you need to do is install a pipe with a drain valve at the bottom wherever you can plug in an air line. When you shut down for the night, turn the compressor off and open these valves. Leave them, and the drain, on the tank open overnight so that any moisture that has condensed in the air lines can drip out.

— Robert W. Lang, senior editor

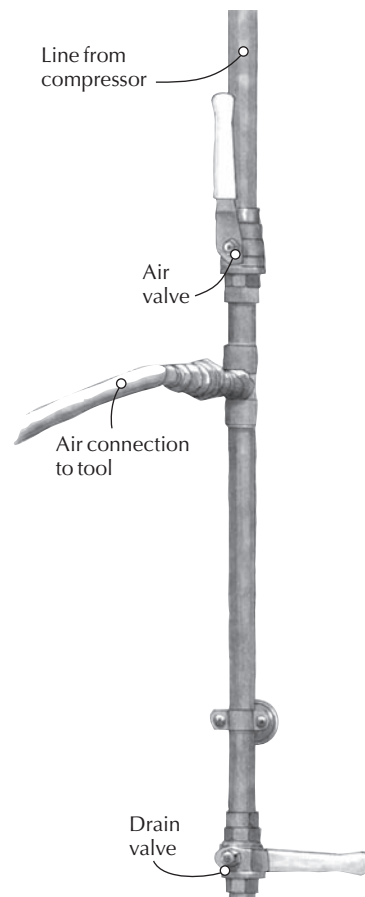

FESTOOL Fantasy Camp & Shop Giveaway

Brought to you by
WOODCRAFT®

Entries must be received by
12 Midnight EST on December 31, 2007.



Register For A Chance To

WIN

- A Shop Full Of FESTOOL Tools – \$3,000 Value!
- Round Trip Airfare To Las Vegas, NV
- 4 Days, 3 Nights Stay In Las Vegas, NV
- An Exclusive 2 Day FESTOOL Training Session Usually Reserved For Dealers!

To Register: Go To woodcraft.com/fantasycamp
Visit A Store Or Call 800-225-1153

QUALITY WOODWORKING TOOLS • SUPPLIES • ADVICE™

How Much Waste is Too Much?

Congratulations on your great Shaker Clock article in the August 2007 issue (#163). I've looked at many tall case clock plans, purchased a few, and built a couple clocks. This plan is by far the most complete and easiest to understand. The drawings and the written instructions are clear and complete.

Could you please estimate how many board feet (bf) of cherry I should have on hand to build the clock?

—Ron Whorton, Tucson, Arizona

I get asked this question many times. Woodworkers would like to have the board footage for the project given within the article. However, the actual figure depends on how individuals work as well as the widths of the rough lumber.



I figure the board feet on a project in one of two ways. First, you can list each piece from the cut sheet and figure that number exactly. Or second, take the overall size (l x w x h of all sides) of the project to determine the number. With either method I use, I also add in a factor for waste. Over the years I've found that most projects use around 30 percent in waste, provided you are milling rough lumber.

For the clock, the board footage is near 28 bf for the primary wood (cherry in my project) and 12 bf of secondary wood (poplar). These numbers have a 30-percent waste factor. Please remember these figures are dependent upon your particular methods in the shop. To be on the safe side, I would order additional lumber. It never hurts to have extra on hand. PW

—Glen D. Huey, senior editor

Question? Comment? We want to hear from you.

Popular Woodworking welcomes comments from readers about the magazine or woodworking in general, as well as questions on all areas of woodworking. We are more than happy to share our woodworking experience with you by answering your questions or adding some clarity to whatever aspect of the craft you are unsure about, and if you have a complaint, we want to address it whenever possible.

Though we receive a good deal of mail, we try to respond to all correspondence in a prompt manner. Published correspondence may be edited for length or style. All correspondence becomes the property of *Popular Woodworking*.

Send your questions and comments via e-mail to popwood@fwpubs.com, via fax to 513-891-7196, or by mail to:

Letters
Popular Woodworking
4700 E. Galbraith Road
Cincinnati, OH 45236

Introducing Another Apollo HVLP Innovation

Meet The New Green Machine™ Ready to Spray When You Are

Apollo Sprayers adds another **smart** innovation for your convenience. Enjoy our new **Handi-Hold™**—Spray Gun Docking Station. Store your spray gun on the turbine in a vertical position. Safe, easy and ready to use.

The Apollo 825 and 1025 Green Machine Turbines offer the newest, cleanest way to achieve the perfect finish, and, they come equipped with the Apollo Atomizer™ Spray Gun, winner of the AWFS Sequoia Award for the most innovative new product. For a whole new finish to your craftsmanship, choose Apollo.

**The perfect combo for
the perfect finish—
from \$799.**

Order Yours Today
888-900-4857 (HVLP)
www.hvlp.com/PW1107



Dept. PW1107



Bob with the Domino

**ORDER YOUR
DOMINO NOW!**



1.866.FESTOOL
(337.8665)
Glen Ridge, NJ

FESTOOL BOB MARINO

SERVICE AS IT SHOULD BE!

Free Shipping!

On Orders of \$150.00 and Up

**No Sales Tax
Collected!**

On Orders Placed Outside New Jersey

- "Excellent customer service is my highest priority"
- "I know the Tools"
- "I use the Tools"
- "They are the only Tools I sell"

See why Festool's lineup of portable power tools is your best choice both in the shop and on-site.

Bob

info@bobmarinosbesttools.com

www.bobmarinosbesttools.com

10% OFF CLAMPS FALL CLAMP SALE 10% OFF CLAMPS

Use Code PWFALL07 When You Order
To Save An Additional 10% Off Advertised Clamp Prices

To Purchase from our large selection of products log onto www.woodline.com or Call 800-472-6950 Today

WOODLINE USA PARALLEL CLAMP SYSTEM

NEW

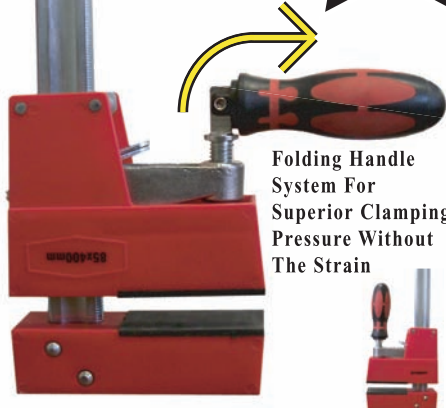

Folding Handle System For Superior Clamping Pressure Without The Strain

- True Parallel Heads provide reliable uniform pressure across the full length of the clamp surface
- Durable Tool Steel Rail for years of reliable service
- Built In Clamp Pad eliminates damage to materials
- Reversible head for push/pull action
- Built in flip-down clamp stand stabilizes for multiple clamp applications

PC-15 - 15" Capacity.....	\$25.95
PC-27 - 27" Capacity.....	\$27.95
PC-39 - 39" Capacity.....	\$32.95
PC-59 - 59" Capacity.....	\$35.95



66 Pc Master Wood Working Router Bit Set

Woodline USA's most comprehensive carbide tipped bit collection features 66 carefully chosen profiles in a fully labeled wooden case. The perfect set to start or complete every woodworkers collection of bits.

ONLY \$189⁹⁵

WL-2066 : 1/2" Shank
WL-2065 : 1/4" Shank

6pc Cabinet Set

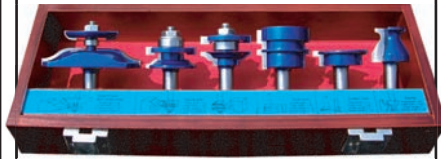

- 3-1/4" ogee raised panel
- 2-piece ogee rail & stile
- reversible glue joint
- drawer lock
- door lip

ONLY \$119⁹⁵
WL-2020-1 : 1/2" Shank



NEW

The Best Clamp/Tool/Guide System for every woodworker

- ★ Reliable cam-action system with variable pressure levels for all your clamping needs ★
- ★ Double T-slot system for limitless accessory jig applications like our NEW Panel Master System ★
- ★ Unique Back-To-Back system that can be separated into 2 individual clamps for unbelievable versatility in all projects ★

25" BlueMax Bar Clamp.....	\$22.95
37" BlueMax Bar Clamp.....	\$24.95
50" BlueMax Bar Clamp.....	\$28.95
25" BlueMax Back-To-Back Bar Clamp...	\$33.95
36" BlueMax Back-To-Back Bar Clamp...	\$35.95
50" BlueMax Back-To-Back Bar Clamp...	\$47.95

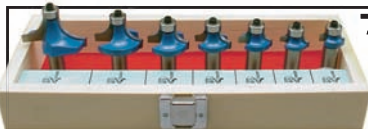

7 Pc Roundover Set

Create the perfect decorative edge for all your projects. Includes 1/8", 3/16", 1/4", 5/16", 3/8", 1/2", 3/4" radius roundovers in a beautiful wood case. The perfect addition to any collection.

ONLY \$45⁹⁵
WL-2002-7 : 1/2" Shank

Woodline USA - 111 Wheeler St., LaVergne, TN 37086 - 800-472-6950 - 615-793-0474 - www.woodline.com



Superior Sharpening in a Compact Station

An engineered sequence of the finest waterstones from Norton are now on one unique, portable system.

Full on-board storage keeps stones, DVD and flattening stone at hand. The unit is a self-contained reservoir – simply rotate the handle to desired stone.

Everything packs away for easy, clean storage.

Ask your Norton distributor how we've made sharpening even easier!



NORTON

D-I-Y/Contractor Market | www.nortonstones.com

THE WINNER:

A Versatile Assembly Bench

Although I have larger workbenches, I find that this specially outfitted small bench works better for putting together many assemblies. Its two adjustable side rails and a rail clamped in the end vise work in tandem to help square up parts being assembled. Each side rail is attached with two threaded male knobs that screw into threaded inserts in the side of the bench through 1"-high x 3"-long L-shaped slots that allow for both up-and-down and lateral adjustments.

To create a 90°-reference form for assembling frames, drawers and other square assemblies, I raise a side rail and slip another board into the end vise. To allow access for installing fasteners, I slide the rails away from the corner of the bench. This also permits assembly of T-shaped intersecting joints, with one member running out through the gap at the bench corner.

The adjustable rails also serve in other ways. For example, I can use them as a workpiece stop when planing or belt sanding. The raised side rails will also restrain a protective hardboard panel for finishing. I attach one end of the panel to a strip of wood that I clamp in the end vise. The side rails help hold the panel in place, and the vise is still usable if necessary.

—John Uhler, Tatamy, Pennsylvania

CONTINUED ON PAGE 22

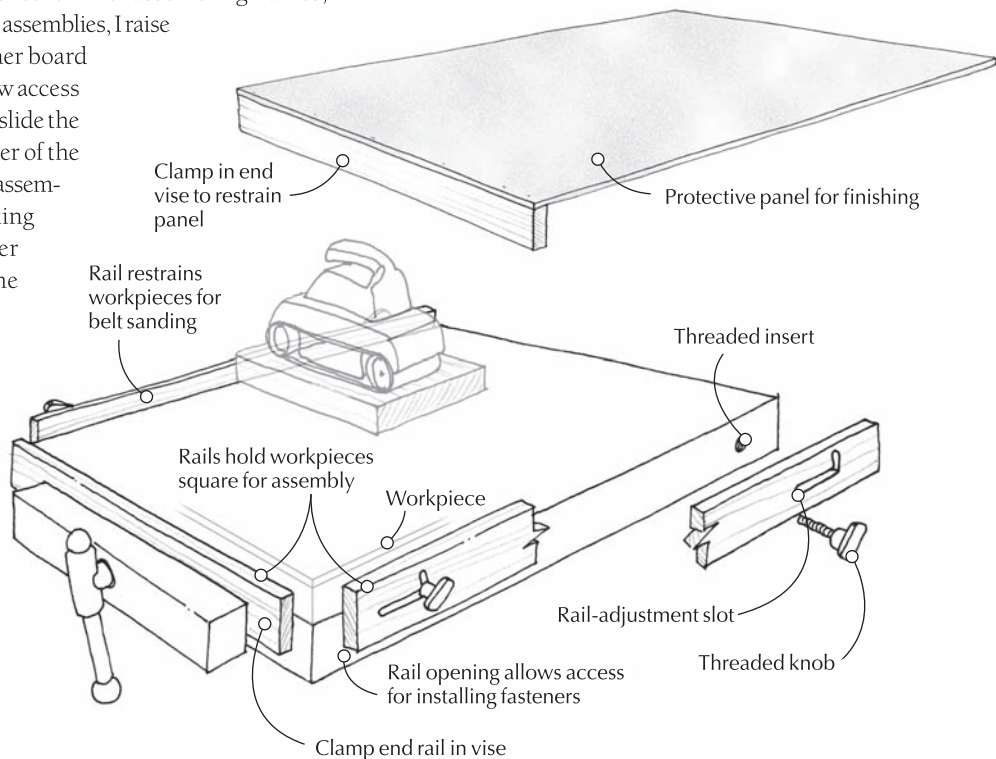

Cash and prizes for your tricks and tips!

Each issue we publish useful woodworking tips from our readers. Next issue's winner receives a \$250 gift certificate from Lee Valley Tools, good for items in the catalog or web site (leevalley.com). (The tools pictured at right are for illustration only, and are not part of the prize.)



Runners-up each receive a check for \$50 to \$100. When submitting a trick (either by mail or e-mail) you must include your complete mailing address and a daytime phone number. If your trick is selected for publication, an editor will need to contact you. All entries become the property of *Popular Woodworking*. You can send your trick by e-mail to popwoodtricks@fwpubs.com, or mail it to Tricks of the Trade, Popular Woodworking, 4700 E. Galbraith Road, Cincinnati, OH 45236.

Sept. 1, 2007-
March 31, 2008
**ROCK SOLID
REBATES**

POPULAR WOODWORKING DIDN'T NAME A SINGLE TOOL OF OURS ON THEIR "BEST NEW TOOLS" LIST.*

THEY NAMED OUR ENTIRE LINE.

When you do things the right way, people notice. So it's no surprise that Popular Woodworking listed our entire line of Steel City tools – something they've never done before – in their annual review of "Best New Tools." Our goal is to create tough, dependable, quality tools with features that serious woodworkers appreciate. Features like the heavy-duty steel ribbing and gussets on our band saws that eliminate vibrations and flexing. T-square-style fences that glide smoothly across the table. And a titanium-coated tabletop on our 10" Deluxe Table Saw that reduces friction and minimizes galling, scratching and corrosion. So how did we know which features woodworkers would appreciate the most? We simply asked ourselves. After all, we've been woodworkers our entire lives.

Visit steelcitytoolworks.com to find your nearest distributor.



**BY WOODWORKERS.
FOR WOODWORKERS.**

* December 2006, Popular Woodworking "Best New Tools of 2006"

CIRCLE #155 ON FREE INFORMATION CARD.

Twin-handled Tool Rack

I use a lot of pliers, nippers, wire cutters, scissors and other “twin-handled” tools at my bench. I never liked having to dig around in a jumble of them stuffed in a drawer, so I took a tip from my electrician dad and mounted them on a board on my bench wall using conduit clips. These commonly available saddle-shaped metal clamps, or “straps,” are sold for attaching electrical conduit to walls, ceilings and other mounting surfaces.

Available in various sizes, they’re perfect for holding one handle of a tool solidly to a wall, leaving the opposite handle extended for easy grabbing. Installing them side-by-side with shared mounting screws consolidates the tools into a small area. And unlike pegboard hooks made for the purpose, the straps won’t accidentally pull away from the wall.

— Bil Mitchell, Riegelsville, Pennsylvania

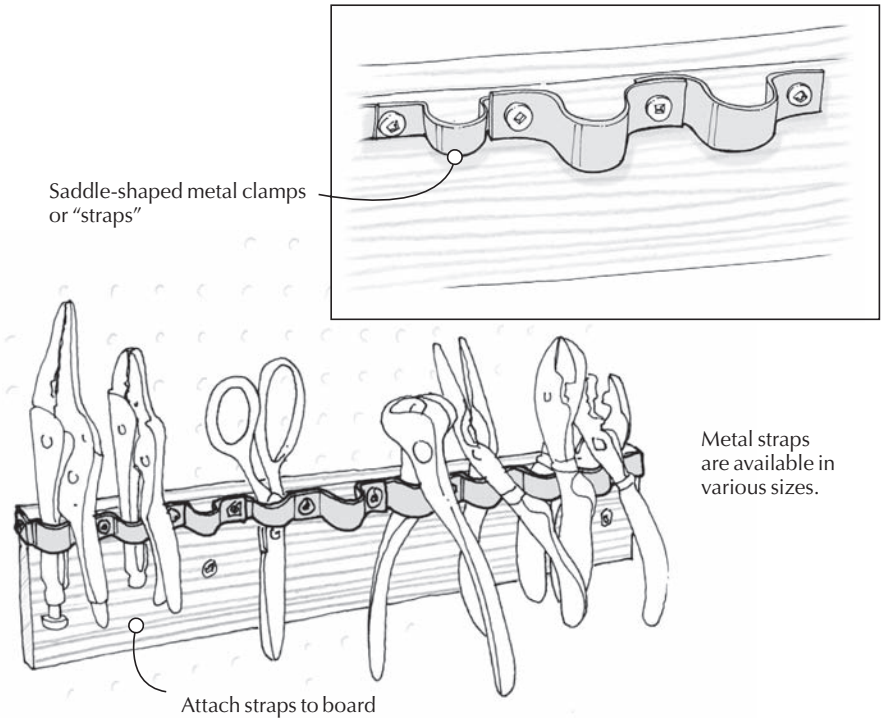

Paint Mixer from Broken Caulking Gun

When I needed to mix two different paint colors to create a new one, I came up with the idea of removing the rod from my broken caulking gun and mounting it in my drill to serve as a paint stirrer. The straight section fit into my drill chuck without modification, while the angled end served beautifully as a rotating mixing paddle. I used my cordless drill to power the mixer, but a corded drill running at low speed would work fine.

— Bob Kelland, St. John’s, Newfoundland

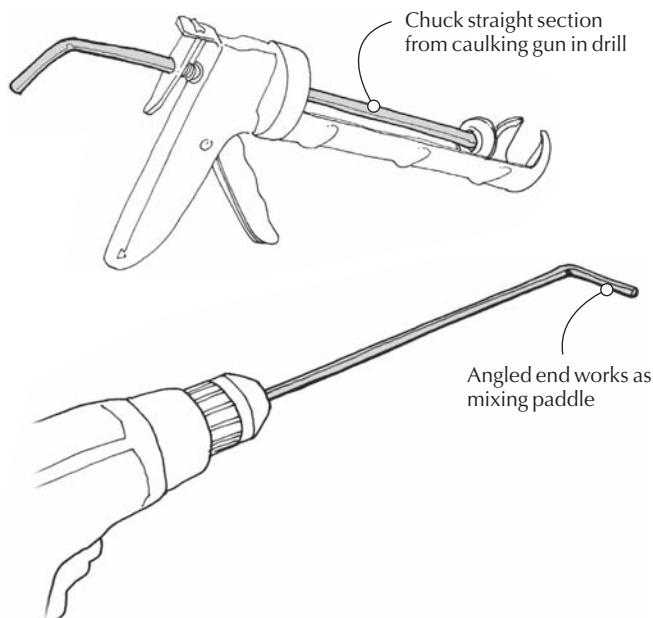

Spindle Sanding with a Drill

Sometimes I find myself needing to sand curved work that’s too big to maneuver on my benchtop spindle sander. In those cases, I bring the sanding drum to the work instead, mounting the drum in a drill. Here’s how:

After selecting the appropriate-sized drum for the job, I mount it on a length of 1/2"-diameter all-thread (which matches the diameter of my sander’s spindle.) I mount a nut and a large washer on one end of the all-thread, slip the drum on, then install another nut and large washer, squeezing the drum tight between the nuts. The remaining section of all-thread slips deep into the chuck on my 1/2" drill, allowing me to sand any area I can reach with the tool. To avoid overworking your drill motor, I don’t recommend doing extensive, heavy sanding in this manner, but it works great for occasional, moderate sanding.

— George Hoffman, Dracut, Massachusetts

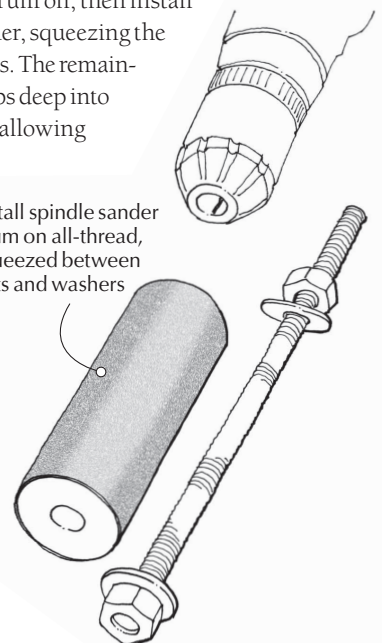

CONTINUED ON PAGE 24



Through, half-blind, sliding dovetails and box joints. **New** single pass half-blind dovetails! Includes bits, guidebush, DVD, etc. Shown with Vacuum & Router Support.

leighjigs.com

800-663-8932



Excalibur
BY GENERAL INTERNATIONAL

21" Scroll Saw

21" Throat capacity.
2" Thickness capacity.
Finger operated blade clamps, no tools required.
Easy access speed and tension controls.
Organized blade storage on base.
Unique tilting head design tilts the blade, not the table keeping the workpiece level for better control & more accurate cuts.

MODEL EX-21

For current promotions, complete product info and a list of dealers near you:
WWW.GENERAL.CA

CIRCLE #120 ON FREE INFORMATION CARD.

Squirrel-Tail Palm Planes

These compact, investment-cast steel planes, with enlarged squirrel-tail handles, are ideally sized for working on small projects and in tight spaces. The sole is 3 3/8" long. Made in Canada.

Until December 24, 2007, we are offering our new palm planes at a special price for the pair. After this date, the planes will no longer be available as a pair.

Flat Palm Plane 15P10.10 \$36.00

Curved Palm Plane 15P10.20 \$42.00

Pair of Palm Planes 15P10.50 \$65.00

Shipping and N.Y. sales tax extra.



The flat palm plane has a rectangular mouth. Both the sole and the straight-edged blade are lapped.

The curved palm plane has a rounded mouth. The sole is rounded side to side (1 1/2" radius) and front to back (12" radius), and the curved-edged blade is lapped.



To order these palm planes, or to request our free 300-page woodworking tools catalog, call or visit us online.

1-800-683-8170
www.leevalley.com



Lee Valley & veritas®

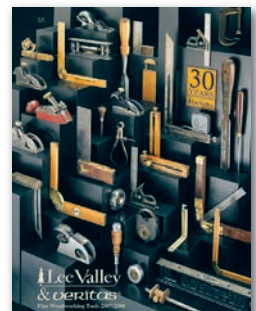

CIRCLE #130 ON FREE INFORMATION CARD.



Woodworker's Hardware

Stocking over 10,000 items for immediate shipment!

Functional Hardware

Hinges, Knobs & Pulls, Drawer Slides

Abrasives & Adhesives

Sheet Stock, Discs, Wood Glue, Titebond

Tools

Bits & Blades, Clamps

Also see:

- Locks • Lighting • Planers
- Fasteners • Kitchen Organizers
- Shelf brackets and much more...

Request a FREE catalog today!
Promotion #805

woodworkershardware.com or call 1-800-383-0130

CIRCLE #166 ON FREE INFORMATION CARD.

Router Table Extension Rail

I made some half-overlay frame-and-panel doors recently, installing the panel a bit proud of the rails and stiles on the front, which recessed the panel on the back side. This isn't an aesthetic problem, but it does create difficulty when routing the rabbet around the edges to create the half-overlay. The doors were rather large, and at points one of the rails and one of the stiles were completely overhanging the router table's top, causing the door to tip, and spoiling the rabbet cut.

What I needed was a larger table top that didn't eat up shop space. As a quick fix, I clamped a long rail to the front edge of my tabletop. That was all I needed to carry a door, keeping it level as I routed the edge. And it turns out that the extra support helps when routing all sorts of large panels. If you're not able to clamp a rail to the front edge of your router table, a couple screws would work just as well, and still allow easy removal when the rail isn't needed.

— Gabriel Castro, Victorville, California

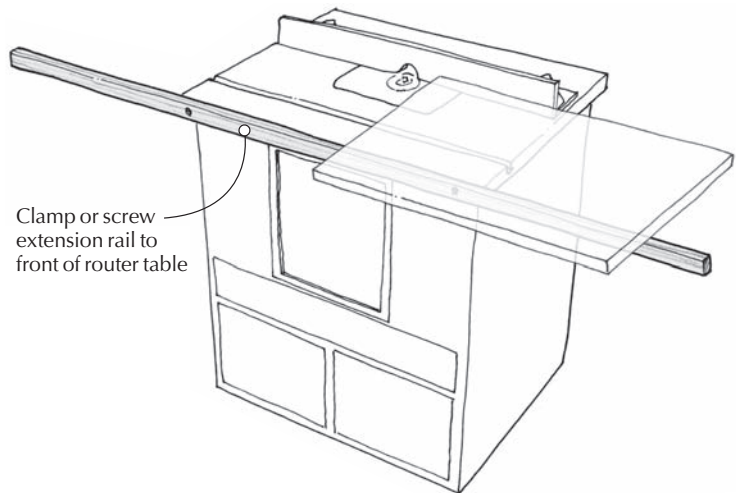

An Overhead Projector Is Useful in the Shop

I find an overhead projector to be invaluable when scaling magazine and book plans to full size, especially when the reduced illustration includes curved lines. I begin by scanning the drawing from the magazine, then printing it on transparent media, available at office-supply stores. I tape to the shop wall a large piece of easel pad paper with 1"-square grid lines printed on it, then move the projector forward or backward until the design lays out to the desired finished size on the grid. The easel paper can then be cut out and glued to the wood stock to establish cutlines. The technique also works great for creating carved or painted signs. You can create the text on your computer, then project it to whatever size you like.

Of course, using an overhead projector in this manner this isn't new. What is new is the easy availability of affordable used projectors these days on the Internet. A quick search of "overhead projectors" on eBay recently yielded about 200 offers, with lots of them costing less than \$50. As far as I'm concerned, that's pretty low overhead for such a time saver. **PW**

— Allen Hyman, Lake Placid, Florida

FESTOOL DOMINO

- See Demonstration Videos @ www.mcfeelys.com/domino
- **Faster** than Dowels, **Stronger** than Biscuits, **more gluing area** too!
- Perfect for **Edge, Butt, Miter** and Complex Joints
- Oscillating Carbide-tipped bit cuts **cleanly and quickly**
- Provides **positive alignment** and **joint strength**



On Any Festool Order FREE FESTOOL Shipping & Handling Over \$150 From McFeely's!

McFEELY'S™

PO Box 44976 • Madison • WI 53744
Toll Free 1-800-443-7937 or at www.mcfeelys.com

CIRCLE #135 ON FREE INFORMATION CARD.

KITCHEN ISLAND LEGS

Stock and custom turnings for your project! Island Legs are available in 10 wood types!

#1550 Classic Island

#1556 Classic Reeded

#1409 Husky Island

#1483 Contemporary Rope

#1461 Sapelo

#1470 Concord



ORDER ONLINE:
www.orderkitchenlegs5.com
 ORDER LINE:
1.800.849.8876
 CALL FOR A CATALOG:
1.800.746.3233

4620 GA Highway 123 • Toccoa, GA 30577 • E-mail: info@osbornewood.com

CIRCLE #141 ON FREE INFORMATION CARD.

Penn State Industries

Create Unique Gifts This Holiday Season with a Penn State Industries' Super Pen Making Starter Set

- Impress your friends and family
- Enjoy a fun, relaxing and creative hobby
- Start now with our easy and affordable all-inclusive starter set



Save \$120
 Super Pen Making Starter Set - #PKPW1
only \$475.00
 and free shipping in continental US



Visit www.pennstateind.com/pw1 or call 1-800-377-7297 for details or for a free catalog filled with top value wood turning products.

CIRCLE #143 ON FREE INFORMATION CARD.

The Best Wood Glue Ever

What makes Titebond® III Ultimate Wood Glue the best ever? It's waterproof, yet cleans up with water. It allows eight minutes of open assembly time and offers an application temperature as low as 47°F.

Plus it's vastly stronger, safer, easier to clean up and less expensive than polyurethane glues.

Titebond® III.

We see it as a natural progression of tradition and excellence. You'll see it as the ultimate wood glue.



1-800-347-4583
www.titebond.com

CIRCLE #118 ON FREE INFORMATION CARD.

Period Details

Use elements of antique furniture to evoke period style.

I've almost finished building my standing desk for my workshop. In this installment, I'll discuss the approach I used to outfit the interior of my desk.

Design: When to Keep it Simple

Thomas Chippendale illustrated a "plain and neat" design for an interior of a desk and bookcase (secretary) in his 1762 book, "Director." It featured a central gallery (of cubbyholes) over a row of three drawers flanked by banks of four drawers, one atop the other. The drawer fronts appear to be flat and otherwise free of adornment beyond Chippendale's characteristically sublime proportions. We often think of Chippendale as synonymous with that which would later be disparagingly called Rococo. His designs typically drip with carved ornamentation. Yet his desk interior appears uncharacteristically restrained.

While American builders, steeped in good taste, toned down Chippendale's Rococo designs regularly, their desk interiors showed a fair amount of ornament. New England desk interiors often featured blockfront or moulded drawers, and doors with shell carvings. This sometimes mimicked the exterior of the piece, sometimes not. Philadelphia builders featured serpentine drawer fronts, arched doors and tiny columns. Some builders created a wrap-around effect (they called it a "winged" desk) or staggered tiny drawers into a sort of terrace.

Architectural influences are evident in most desk interiors. Columns, arched doorways and galleries make the desk into a tiny courtyard. Almost all of the finest pieces include a center door (called a "prospect") as a focal point. When present, these doors are often flanked by columns, or are curved, carved or made from figured wood.

Lastly, secret compartments are typical. These may have been there simply to amuse



The show is inside. I patterned the inside of my desk after mid-18th century desks. I'll wrap up this series in next month's issue when I apply the finish and attach the hardware. I don't know about you, but I'm looking forward to seeing this done!

the buyer, but it's possible they were included to safeguard valuables.

Some secret compartments are fairly pedestrian, but others include tricky wooden spring locks or the like. I didn't make any secret compartments in my desk, but I can see how they would be great fun to build.

Structure: A Box in a Box?

Nineteenth-century desks used a carcass-inside-a-carcass approach. The fitted drawers and cubbies were contained in their own carcass, and slid in from the rear. Eighteenth-century desk interiors often didn't have sides and sometimes didn't have tops either. Individual components were attached to the desk carcass by way of shallow stopped dados and ever-present glue blocks. Due to space limitations, this is the method I am choosing, but if I had more space, I would have preferred to build a separate carcass for the interior.

Preparing Thin Stock by Hand

For this project, I needed stock considerably thinner than I typically use. The period pieces I examined used $\frac{1}{2}$ " stock and thinner. I chose to prepare all my main structural pieces at a $\frac{3}{8}$ " thickness because I have a good $\frac{3}{8}$ " dado plane. The drawer blades and the cubbyhole dividers in the galleries were on the full side of $\frac{3}{16}$ ", again because that was the size of my smallest firming chisel.

Joinery: Two Kinds of Dados

The desk interiors I've seen were all assembled with dados and glued. Two sorts of dados are used seemingly universally: Stopped dados and stopped dados with a V-groove. Their use depends on how you want the intersection to look. When you can hold one piece back from another, the stopped dado is used. Where you need a flush intersection, the V-groove gives a mitered appearance.



Resawing by hand. I sawed around the edges of this board. You may be able to see the saw marks. I can get a nice uniform thickness out of even cupped stock. This piece is 11¹/₄" x 20" and took five to 10 minutes to resaw. I don't know how long this would take with a machine, but I think 10 minutes is a long time to spend sawing, and I was glad I didn't have a lot of this to do.

Cut like a tenon. The technique I use for resawing is exactly the same as my approach for any other saw cut. I start by sawing a corner out, maintaining square by watching the cut on both lines. Though you might be tempted to use your thinnest saw, the coarsest saw will do the quickest work. The problem is clearing the saw dust from the kerf. Whenever possible, it seems better to saw vertically than horizontally.



No clamps needed. They say a woodworker can't have too many clamps. I only needed one for this hot hide glue rub joint; I used it to set the glue pot on! Butt-jointed primary and secondary woods are fairly common on the desks I looked at. In Philadelphia furniture, white cedar or tulip poplar are typical secondary woods, but they are almost always quartersawn, and evidence of riving marks are not uncommon.

Dividers are hidiers. The gallery divider rides in a stopped dado. The divider overhangs the end of the dado so its rounded profile doesn't reveal the end of the dado.



Looks like a miter. The horizontal drawer blade rides in a stopped dado. But a V-groove extends to the front surface, giving a mitered look. This is essential for elements like these with rounded front edges.

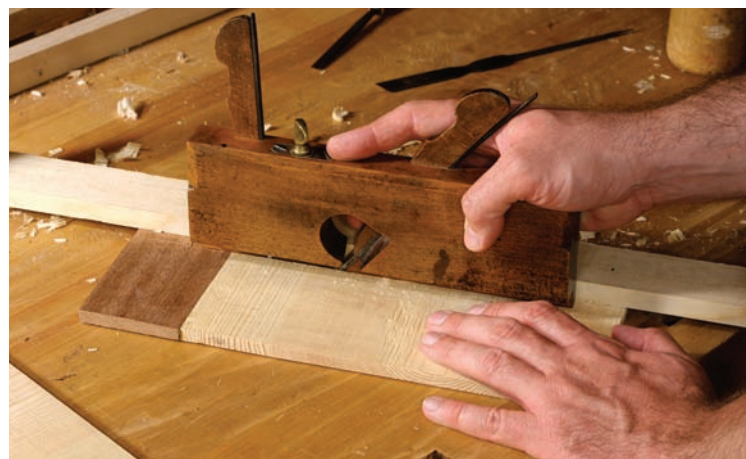

Dado plane and simple. I begin my stopped dado by nailing a fence to the workpiece. I first draw my dado plane backward to score the work using the plane's nicks (which are secured by the wedge in front of my index finger). Note that I'm not clamping the workpiece to the bench, just banking the fence against a holdfast in my bench.



The dado plane's results. I can't finish the job with the plane, but it makes for a quick start. The plane has at least accurately marked out the dado for me. I score the sides with a wide chisel.



Pare the rest. Then I pare away between the lines until I reach the depth I need (about $\frac{1}{8}$ "). There's no need to use my router plane for this. I can easily eyeball $\frac{1}{8}$ " and get the depth consistent enough. Note the chisel technique!



Kick it up a notch. The finished joint makes a tight fit. Notice how the board with the dado is notched to overhang the stopped dado it attaches to. This is common practice. The board on the top is waiting to be notched. I dry-fit the two together first, then mark where the notch should be.

Ornamentation Decided by Tools

I used a few simple methods to recreate period details. Wherever I had curves to cut, I used my gouges instead of making templates. It was fast, accurate and the gouges were helpful for cleaning up the curved surfaces.

This—using the shape of your tools to create the shape of your details—is called “tool slaving” and I have little doubt that this was common practice in period woodshops.

Conclusion: No Conclusions

Before starting this interior, I examined a few period pieces and looked at many photos. I was hoping to find a typical structure that I could copy.

Instead, I found each interior as unique as its maker. Drawers were shaped differently and arranged differently. At this point, I can't offer you “here's the way it was done back then,” as I observed no clear consensus.

Instead, I assembled my interior by drawing on recognizable period details. I included design details such as the serpentine drawer fronts and the cubbyhole gallery, and construction details such as the stopped dados and dados with the V-grooves. I used ornamental elements consistent with my other choices, choosing the rounded arches and double arch moulds. And I did all this without project plans or even a comparable example.

Some believe that period furniture making is too restrictive. One reader asked: “Why would anyone want to limit themselves to only making things that were made before?” I guess I just don't see it that way. I thought this was a very creative part of the desk project, offering many opportunities for me to express my sensibilities and exhibit my sense of craft. For me, period furniture making is like speaking



Create the “V.” When a dado with a V-groove is called for, I make a stopped dado as before, then carve the V-portion with a V-gouge. The heel of this particular gouge is slightly rounded. So I crisp up the bottom of the cut with a firming chisel. There's just a ton of chisel work for a project like this. I like using my chisels, so this was fun for me.



Scrape your profile. This gorgeous little double-arch mould was a breeze to make. I made a scraper out of a leftover piece of saw blade. Five minutes with a chainsaw file and voila! This drawer blade follows the contour of the drawers above and below it.



Tool slaving in action. In this picture, I'm laying out the serpentine drawer fronts. I made these drawers by simply carving them out, and I finished them with a scraper. I was careful not to carve away the pencil line in the center of this drawer front. That let me clamp this piece in my vise to saw the pins for the dovetails. On New England drawers, they scalloped the whole front out. I'm not sure how they'd hold that drawer front in a vise. They may have done the scalloping after the drawer was built. I think this Philadelphia serpentine drawer front is nicer looking and easier to work with!



Difference is in the detail. I think it's the little details that give this interior its charm. The vertical divider in this picture is just a little over $\frac{3}{16}$ " thick. The inconsistencies, ever-present by my admittedly ham-fisted work, give things like this an unmistakable and alluring intimacy. They remind us that this was all made by hand—by a human being.

a foreign language. The vocabulary I use is indeed restricted to that language, but what I say is entirely my choosing. **PW**

Visit Adam's blog at artsandmysteries.com for more discussion of traditional woodworking techniques.

Forrest Blades

Quality Blades for America's Craftsmen

Serious woodworkers demand perfection. That's why so many of them choose Forrest saw blades.

Forrest quality is legendary. Our proprietary manufacturing process, hand straightening, and unique grade of C-4 micrograin carbide give you smooth, quiet cuts without splintering, scratching, or tearouts. In fact, independent tests rate our blades as #1 for rip cuts and crosscuts.

Forrest saw blades are simply the best that money can buy. They're made in the USA by the same family-owned business that's been producing and sharpening them for over 55 years. And they're backed by a 30-day money back guarantee. It's no wonder that serious woodworkers give them such high praise!

"Your blades are without question the best by miles, and I have tried them all."

Bob Jensen—Fridley, MN

"These are the finest blades I have ever owned and you should be proud of your quality product."

Patrick T. Hankard—South Windsor, CT

"[Forrest blades] cut true, with no vibration. I was a carpenter by trade for over 60 years and continue to be an active woodworker. So, I can say with confidence that Forrest blades are the best."

Carl Stude—Burbank, CA

The message is clear. If you're looking for quality, performance, and value, it pays to choose Forrest blades every time.

Our Most Popular Blades:

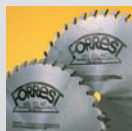

Woodworker II – This award-winning, all purpose blade is the finest of its type. It turns big jobs into easy-to-handle ones.

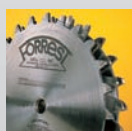

Dado-King – The world's finest multi-tooth dado set. It works effectively in all directions—with the grain or across it.

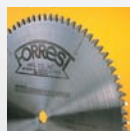

Chop Master – Produces perfect miters every time—with no bottom splinters. You get smooth edges on all types of wood.

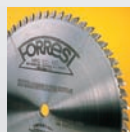

Woodworker I – Great for table and radial saws. It trims and crosscuts all woods up to 2" and is ideal for plywood.

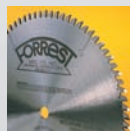

Duraline Hi A/T – Our best blade for birch and oak ply veneers. It also delivers a clean cut on melamine and vinyl over particle board.

Forrest blades come in a wide variety of sizes and are available for practically every application. Call or send for our complete list of products.

Three Convenient Ways To Order

We back our blades with a 30-day money back guarantee. So, choose the method most convenient for you and order today:

- Visit one of our fine-quality dealers or retailers.
- Call us toll free at 1-800-733-7111. (In NJ, 973-473-5236) Ask about special discounts, free shipping on orders over \$275, and discounts for blade sharpening.
- Contact our internet store: www.ForrestBlades.com

FORREST

The First Choice of Serious Woodworkers Since 1946

Ridgid's New 13" Portable Planer

Four posts, an extra knife and a new dust hood make it a contender.

Most woodworkers consider the thickness planer to be one of the most important machines in a woodshop. As a result, many manufacturers have produced a variety of sizes in planers. None has been written about as much as the 13" portable planer.

This size planer has gone through a multitude of changes over the years with each transition making it a better machine. More features are being added, and the tool is growing into a workhorse in most home shops.

Ridgid has an improved version of its portable planer, the new R4330. This 15-amp machine has new features, but it retains the useful features from the previous model.

The improvements start with the guts of the machine. What used to be a two-knife cutterhead is now a three-knife design. Also, the rpm was increased by more than 10 percent. The planer now produces 30,000 cuts per minute (CPM) versus only 18,000 CPM with the prior unit. That greatly improves the cutting performance of the machine.

Plus, the newly designed knives are still of the dual-edge, quick-change variety; each is self-indexing and self-aligning, and you can adjust the knives from side-to-side to compensate for small nicks. A complete knife change can be accomplished in 30 minutes or less.

According to Ridgid, differences in the appearance of finished cuts from either of the two cutting speeds on competing models was negligible, so the company decided against a two-speed function for the R4330 planer, settling on a single speed of 96 cuts per inch at a feed rate of 26 feet per minute.

A significant design change in the R4330 planer is a four-post design on which the



Ridgid 13" Thickness Planer

Ridgid ■ 800-474-3443 or ridgid.com
Street price ■ \$349

For more information, circle #169 on Free Information Card.

cutterhead travels instead of the two-post design used in the past. Ridgid officials said the cutterhead is secure enough in this design that it eliminated the depth-of-cut locking mechanism from the machine.

On portable planers, as with the R4330, snipe is controlled by adjusting the infeed and outfeed tables. However, right out of the box, this planer showed little snipe and it was at the trailing end of the board. So little in fact, that regular sanding would correct the problem.



Choose the collector. The improved dust hood works with either a 2½"- or a 4"-diameter hose.

An improved dust hood that opens and closes by simply rotating the hood door is a nice added feature. No planer should be used without proper dust collection, but there are times when being able to open the door to clear an obstruction is an added benefit.

The "Repeat-A-Cut" and "Ind-I-Cut" features are from the previous model. I found the Repeat-A-Cut feature handy to use. Being able to reach one of eight different thicknesses by selecting a predetermined depth stop builds accuracy into your work. I did, however, find the Ind-I-Cut feature to be a bit fussy and not as accurate to use.

Ridgid's 13" portable planer is available at Home Depot for \$349. That's a savings of \$50 versus the older model. However, no extra set of knives is included and if you want a stand it'll be extra, too. Also, check the box to ensure you're buying the new machine. Both models have identical Home Depot SKU numbers.

—Glen D. Huey

CONTINUED ON PAGE 32

PHOTOS BY AL PARRISH & STAFF

CENTER for FURNITURE CRAFTSMANSHIP

Teaching
Creative Excellence

WORKSHOPS

TWELVE-WEEK INTENSIVES

NINE-MONTH COMPREHENSIVE

STUDIO FELLOWSHIPS



Amatory Chair by Instructor David Uffler-Brown

Rockport, Maine ■ 207-594-5611 ■ www.woodschooll.org

1-800-327-2520
www.lie-nielsen.com
Warren, ME

Lie-Nielsen TOOLWORKS INC.



Large Router Plane \$125.
Small Router Plane 75.

CIRCLE #131 ON FREE INFORMATION CARD.

We walk the talk.



Hand tools for the serious woodworker

800.426.4613 - 27 W. 20th St., #507 New York City

TOOLS FOR
WORKING WOOD

www.toolsforworkingwood.com

CIRCLE #157 ON FREE INFORMATION CARD.

RAZOR SAW

It cuts FASTER! EASIER! MORE
ACCURATELY!

Order now, only \$25.95 post paid!

Craftsmen around the world have discovered the secret of better quality work. The Razor Saw cuts by pulling and will give a cleaner, more accurate cut in half the time.

Purchase a RAZOR SAW now and we will include our 102 page catalog of the world's finest woodworking tools. Or send \$2.00 for a two year subscription to our Catalog.

The Best handsaw for ALL woodworkers!
www.japanwoodworker.com
Dept P1

THE JAPAN WOODWORKER
1731 Clement Ave. • Alameda, CA 94501 • 1-800-537-7820

CIRCLE #127 ON FREE INFORMATION CARD.

Woodworking Magazine —The Book

Get your hands on *Woodworking Magazine* — now in book form!

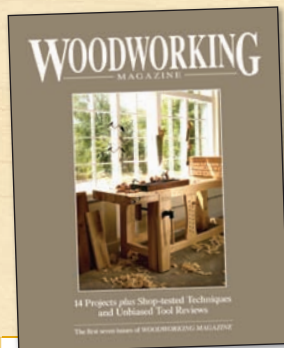

We're pleased to offer the first seven issues of *Woodworking Magazine* in book form—252 pages and the only place you'll find the sold-out issues in print form.

It's the perfect way to ensure your collection lasts for years to come, and great gift for any woodworker on your holiday list.

Order your copy today at
woodworking-magazine.com/books

QUANTITIES
ARE LIMITED
**ORDER
TODAY!**

WOODWORKING

MAGAZINE

JessEm
Tool Company

Love At First ...Slide!

THE NEW

Mast R Slide™



JessEm's New **Mast-R-Slide™** Precision Sliding Cross-Cut Table is the ultimate add-on for your tablesaw. Thirty double-sealed precision bearings in an innovative linear guide mechanism provides an exceptionally smooth and accurate cross-cutting solution. Fits most tablesaws and offers a maximum cross-cut of 36 inches. Upgrade your saw with a **Mast-R-Slide™** from JessEm Tool today.

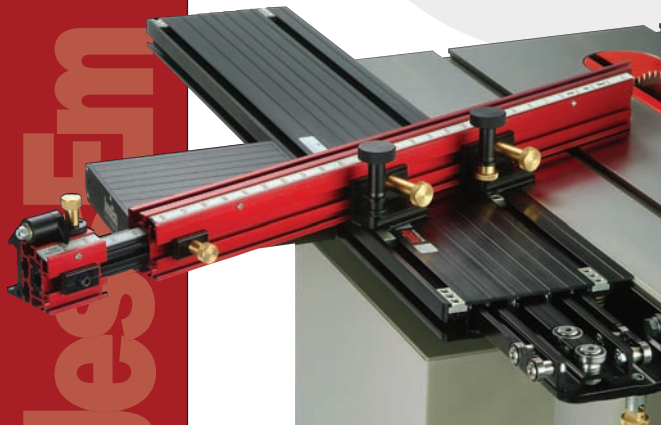

Visit us at www.jessem.com
Call: 866-272-7492 • Greeneville, Tennessee

CIRCLE #128 ON FREE INFORMATION CARD.

Metabo Random-orbit Sander is Easy on the Hands

Stop in most any woodshop and you'll find a random-orbit sander or two whirling away while preparing a project for the finishing steps. In the shop, these small hand-held sanders have assumed the majority of the sanding work—at least that of final sanding.

Metabo's FSX200 is listed as a palm-grip random-orbit sander. Don't confuse it with a regular 1/4-sheet palm sander; this is a true random-orbit sander. The palm grip describes how the sander conforms to the operator's hand. It fits comfortably to say the least.

Once you place your hand around the non-slip soft rubber grip body, you'll notice how your index finger is appropriately located in line with the sealed, dust-resistant on/off switch. The rubber coating also reduces vibration, and that translates into less operator fatigue during prolonged use.

The FSX200 possesses the necessary features to make it a top-notch sander. The 2.2-amp motor spins the hook-and-loop pad at 9,500 orbits per minute. With an orbit size of 1/8", the sander allows you to maintain control of the tool while sanding, and you'll find

it aggressive enough to remove material while using a coarse sanding disc. Install a finer disc on the 5", eight-hole pad and the sander performs equally well. The FSX200 sander is light at 3.4 pounds, making it practical for one-handed operation.

Metabo has taken steps to cover both vacuum-free and vacuum-assisted dust collection. Vacuum-free dust collection is achieved with an onboard collection box and a fluted filter. Flip open the flap, pull the filter from the box and knock off the dust. Remove any residual dust with a brush, then replace the reusable filter for further sanding.

If you like to connect to a vacuum system, Metabo has added a dust-extraction connec-



Metabo FSX200 Sander

Metabo USA ■ 800-638-2264 or metabousa.com

Street price ■ \$80

For more information, circle #170 on Free Information Card.

tion that fits directly to a 1 1/2" hose. Slip off the collection box, snap on the connection and you're all set to work. —GH

Lee Valley Squirrel-tail Planes are Handy Little Tools

Small planes are great for small jobs, not only in the workshop but also around the house. I've long kept a little guy in my tool bucket for adjusting sticky cabinet doors and flushing up trim around the house.

Lee Valley Tools has just released two little planes (under its new Utilitas brand) that should go on your Christmas list. These two planes are identical except for their soles. One has a flat sole. The other has a spoon-shaped sole, which makes it useful for hollowing out concave surfaces.

The sole of that plane curves in a 1 1/2" radius side-to-side and a 12" radius front to back. It is similar to an old Stanley model that was designed for model makers, though I've also found the tool useful for the final shaping of the saddle of a Windsor chair seat.

Both planes have a rear handle that resembles a squirrel's tail. This makes the plane easy to hold and keeps your palm away from the rear edge of the tool's cutter. The blade-clamping mechanism is dead-nuts simple and ingenious. There's a star-shaped wheel

below the cutter that levers the cutter up against two metal bosses in the sidewalls of the tool. The mechanism, though simple, is rock-solid. The tool won't chatter on you during a cut.

Once you secure the cutter you can adjust it in the mouth of the tool using small hammer taps or by other means.

Both of these tools have wide-open mouths with the cutter bedded at 45°, so they shouldn't be your first choice for dealing with tricky woods or for lots of end-grain trimming. But for the face grain and edge grain of softwoods and mild hardwoods, the planes do a great job.

Setting up these tools for use is perhaps their most stunning feature. Lee Valley has lapped the cutters dead flat, so honing the 1"-wide cutter takes just a few minutes at most. The soles also are lapped flat. These tools have tolerances that a machinist would love.



Squirrel-tail Planes

Lee Valley Tools ■ 800-871-8158 or leevalley.com

Street price ■ \$36 and \$42

For more information, circle #171 on Free Information Card.

Despite the premium manufacturing and materials, the prices of each are reasonable. The flat-soled plane is \$36. The curved-sole plane is \$42. —Christopher Schwarz

INNOVATIVE SHOP SOLUTIONS

What's under your machine?



Machines up to 1,800 lbs. Glide with Ease on an HTC Mobile Base.



(800) 624-2027 • WWW.HTCPRODUCTSINC.COM

CIRCLE #125 ON FREE INFORMATION CARD.

WOODCRAFT®

Your Best Work Starts With Us!

With over 15,000 of the finest woodworking tools in the world, Woodcraft can help you work more efficiently and skillfully than ever. Call for your FREE copy today.

FREE Tool Catalog!

1-800-542-9115
woodcraft.com

406 Airport Industrial Park Road
P.O. Box 1686
Parkersburg, WV 26102-1686

Visit one of our stores located nationwide! Call us for the store nearest you.



Dept: C07PW110

QUALITY WOODWORKING TOOLS • SUPPLIES • ADVICE™

CIRCLE #174 ON FREE INFORMATION CARD.

Sliding Power.

NEW



3 HP Sliding Table Saw MODEL 10-110

- Accepts 29/32" Dado
- 58" Rip Capacity
- 49" Sliding Carriage
- Magnetic Bump Switch
- 5/8" Arbor
- Crosscut Fence



Table Insert w/ Depth Indicator



Heavy Duty Cast Iron Trunnion



Triple Drive Belt System

RIKON

www.rikontools.com

877-884-5167

CIRCLE #150 ON FREE INFORMATION CARD.

H.N.T. Gordon A55 Smoothing Plane

Just as there are people who always choose white meat at the Thanksgiving table and those who always go for the dark meat, there are woodworkers who prefer only wooden-bodied planes or only metal-bodied planes. These two groups disagree on how much a plane should weigh, how it feels in use and the features it should have.

And while there are some wooden-bodied planes that have made overtures to the metal-bodied plane users, no plane has done as good a job as the new A55 smoother from Australian planemaker H.N.T. Gordon.

The A55 has handles and controls that feel like a metal-bodied plane, yet it offers the sweet wood-on-wood feel of a wooden plane. Speaking as a lifetime member of the metal-bodied plane club, I'm impressed.

The A55 has a lot of good features: The iron is bedded at 55°, an excellent pitch for nasty hardwoods and reverse grain. You can even flip the iron over and turn the tool into a scraping plane. The mouth of the tool and the abutments for the tool's wedge are all brass, which

makes them durable for the long haul.

Plus, the plane has a sweet tight-tolerance adjuster that works like a Norris-style adjuster as it controls both the blade projection and whether it's centered in the mouth.

In use, I found the plane to behave much like a metal plane, but without the weight. The low-slung rear handle feels familiar. And the position of the controls allow you to work much like you would with a traditional metal plane. There's even a place to rest your index finger. In fact, my only complaint with the tool is the escapement. I wish it were larger. Even though I was taking fine shavings, the mouth would quickly fill up. While the mouth didn't clog, it did require me to stop occasionally to clear things out.



Gordon A55 Smoother

Craftsman Studio ■ 888-500-9093 or craftsmanstudio.com

Street price ■ \$260 or \$278

For more information, circle #172 on Free Information Card.

Also, Gordon planes wear like iron. The A55 is available in tough gidgee (\$278, above) and ironwood (\$260). There also are exotic steel blades available for scraping. All in all, the A55 is an excellent piece of work.

—CS

Zem Hearing Protection

You can't argue about the need for good hearing protection, but there is a good argument against how we've been achieving it. Ear muffs and standard earplugs block the sound from noisy machinery and tools, but they also block sounds that you want to hear, such as the phone, the radio or someone coming up behind you to ask a question.

Zem hearing protection is a lightweight solution that offers a noise-reduction rating of 26 decibels, yet still allows you hear many normal sounds. Foam inserts go in your ear as normal earplugs do, but at the end of each is a hollow plastic tube. The tubes are engineered to direct harmful sound levels away from your ears, yet allow everyday noises to get through to your auditory canal.

The tubes are connected at the top with a spring that keeps the earpieces firmly in place. This design keeps the tubes away from the side of your head, so there is no interference between safety glasses and hearing protection. The downside to this is that while these are light in weight, pressure is constantly applied to the opening of the ear.

For me, these were more comfortable than

in-the-ear devices, and about the same level of comfort versus annoyance of ear muffs. Ear muffs are heavier and interfere with eyewear, but I found the sensation of having something poking in my ear uncomfortable when wearing them for more than a few minutes.

The level of sound reduction was impressive; these block the sound of a planer or router as well as do the earmuffs I usually wear. My ability to hear other sounds, such as the radio or a normal conversation, was somewhat diminished. I could tell that the radio in the shop was on, but I couldn't hear it clearly. I could carry on a conversation, but when anyone started talking, I ended up removing the Zem so I could hear clearly and not have my own voice echoing in the tubes.

This is a good system, but the issues of comfort and hearing normal sounds clearly would keep me from wearing them all day. As a wear-it-when-you-need-it device, they are very good. They work, don't interfere with safety glasses and fit comfortably around the neck when not needed. Other colors are available, as are replacement foam ear inserts. **PW**

—Robert W. Lang



Zem Hearing Protection

Sensgard ■ 877-208-0883 or zemzone.com

Street price ■ \$24.99

For more information, circle #173 on Free Information Card.

FREE Zero Glare BR-6 Pocket Rule!

Use Promotion Code:

PWM1107

With your next online purchase of \$75 or more!

New Website!

www.BridgeCityTools.com

Serving Woodworkers Worldwide for Over 24 Years!

CIRCLE #109 ON FREE INFORMATION CARD.



(Limit One Per Customer)

Lowest Prices Guaranteed!

FREE CATALOG!

Your Source For Essential, Unique, & Hard To Find Tools!

Hartville Tool
WOODWORKING

800-345-2396
hartvilletool.com

CIRCLE #124 ON FREE INFORMATION CARD.

Finest Quality Reproduction
BRASS & IRON HARDWARE

Since 1933, Ball and Ball has been manufacturing the highest quality reproduction furniture hardware, builders hardware, lighting fixtures, and fireplace accessories available.

Call for our 108-page catalog available for \$7.00. (catalog cost refunded on first order)

463 W. Lincoln Highway (Rt. 30)
Exton, PA 19341
610-363-7330 • Fax: 610-363-7639
1-800-257-3711
www.ballandball-us.com

BALL AND BALL
HARDWARE REPRODUCTIONS

CIRCLE #104 ON FREE INFORMATION CARD.

FOR THE TOUGHEST JOBS ON PLANET EARTH.™



GORILLA TOUGH™



From building, to creating, to repairing and more.

1-800-966-3458 • GORILLATAPE.COM

© 2007 The Gorilla Glue Company. T3HD

CIRCLE #121 ON FREE INFORMATION CARD.

CUT PERFECT EDGES & FLAT BOTTOMS WITH AMANA TOOL'S® NEWEST SUPER FINE DADO SET

Set also provides multiple combinations for **Undersized Plywood.**

Amana Tool's® latest industrial quality dado head, sets the standard for super smooth, flat-bottom cuts for both along and across the grain.

Perfect for Wood, Melamine & Laminates, Veneered Plywoods, Crosscutting and Ripping.

"This carbide tipped dado set cuts incredibly clean with absolutely no tearout or ragged edges"
- Lonnie Bird



\$199.95 Amana Tool #658060
List Price \$364.00

8" x 24T WITH SIX 4-WING CHIPPERS
Includes Free Shim Set for fine adjustments



Amana Tool® REDEFINING WOODWORKING™
For A Dealer Nearest You Call 1-800-445-0077
Visit Our Website www.amanatool.com
Above price at participating dealers



ASK LONNIE BIRD
For tips & techniques visit our Q&A column online
www.amanatool.com

CIRCLE #100 ON FREE INFORMATION CARD.

Shaker-inspired Step Stool

Pocket screws serve as clamps for panel glue-up.

Inspired by a typical Shaker step stool, this version employs pocket screws to join both the side panels and the supports. To cut down on the number of rip cuts, I used three pieces of 1x6 dimensional lumber to form the side panels (1x6 actually measures $\frac{3}{4}$ " x $5\frac{1}{2}$ "), so this version also ends up a bit deeper than a traditional Shaker stool – and thus a little sturdier and beefier looking.

First, use your miter saw to cut the 1x6 pieces to length for the side panels. You'll need two each at $20\frac{1}{4}$ ", $13\frac{1}{4}$ " and $6\frac{1}{4}$ ".

Now, clamp one of the $20\frac{1}{4}$ " pieces flat to your bench (face side down), and drill holes for two pocket screws along the edge that will meet the middle piece. Place one hole 2" from the bottom edge, the other at 11". Repeat with the second $20\frac{1}{4}$ " piece. Now drill each $13\frac{1}{4}$ " piece along the edges that will meet the short pieces. Locate one hole 3" from the bottom edge, the other at $5\frac{1}{4}$ ".

Next, it's time to glue up the side panels, and this is where the pocket screws come in

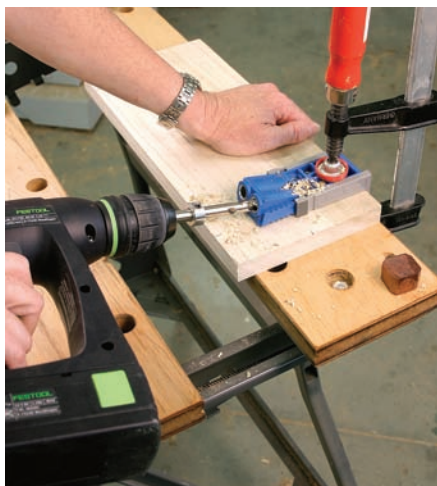

Shaker-inspired step stool. Don't let the panel glue-up scare you. This step stool (useful in just about any room of the house) is easy to build, using pocket screws as clamps and to add strength.

handy – especially if you're short on clamps. Run a bead of wood glue along the edge of one of the $6\frac{1}{4}$ " pieces, then line up that piece and a $13\frac{1}{4}$ " piece flush across the bottom, and flat across the panel, then clamp across the two. Drive screws into the pockets to join the two pieces together. Now that the screws are in place, you can unclamp and move on to joining the $20\frac{1}{4}$ " to the $13\frac{1}{4}$ " piece. Do the same with the other side panel.

Once your glue is dry, lay the panel screw-

Drill the side panels. To use pocket screws to assist with panel glue-up, clamp the side pieces flat to your bench, and drill pocket holes to join the panel pieces. Here, I'm drilling the middle board with one hole 3" up from the bottom edge (it will get cut away when you cut the arc) and another hole $5\frac{1}{4}$ " from the bottom edge.



Online EXTRAS

For a slide show of how this project is assembled, go to:

popularwoodworking.com/nov07

side up flat on your bench, and mark the center point across the bottom edge (it should be at $8\frac{1}{4}$ "). Now, using an offcut as the base for the compass point, measure 2" down from the center point, place the compass point there, and draw the arc. Use a jigsaw to cut out the arc (you'll be cutting away the two bottom screws), then clean up the cut using a rasp and sandpaper.

Use a miter saw to cut the three step supports and back brace to $15\frac{3}{4}$ " out of 1x2 (which actually measures $\frac{3}{4}$ " x $1\frac{1}{2}$ "). Clamp

Shaker-inspired Step Stool

NO.	ITEM	DIMENSIONS (INCHES)			MATERIAL
		T	W	L	
❑ 2	Long panel piece	3/4	5 1/2	20 1/4	Poplar
❑ 2	Middle panel piece	3/4	5 1/2	13 1/4	Poplar
❑ 2	Short panel piece	3/4	5 1/2	6 1/4	Poplar
❑ 3	Step support	3/4	1 1/2	15 3/4	Poplar
❑ 1	Back brace	3/4	1 1/2	15 3/4	Poplar
❑ 3	Treads	3/4	5 7/8	18 1/4	Poplar



Panel glue-up. Use a clamp to hold your panel pieces together as you seat the pocket screws. Once the screws are in place, the clamp can be removed.



Quick and easy screwing jig. A scrap of 2x4 is clamped to the Workmate to serve as a guide and support for screwing the step supports and back brace in place on the side panels.

each piece flat and drill one pocket hole into the center at either end. Set them aside.

Now, out of 1x8 (actually 3/4" x 7 1/2"), cut the three step treads to their final length of 18 1/4", then clamp a piece flat to your bench, with one long edge overhanging. Use your jigsaw to rip each tread to a width of 5 7/8". (You'll get a straighter cut if you clamp a straightedge

in place to guide the foot of the jigsaw.)

Now all the pieces are ready for assembly; this is a good time to sand (because as yet there are no corners to deal with). Sand over the panel joints to ensure the panels are flat. If you're planning to paint, sand to #120; if staining, you may want to sand to #180.

Joining the step supports and back brace to the sides is a bit tricky, involving some creative clamping and a scrap of 2x4. Separate the two halves of your Workmate so you can get clamps through the middle, then clamp the 2x4 scrap tight to the table. Butt the front edge of the bottom riser (the short piece in the panel) flush to the 2x4, and clamp the panel to the table. Hold the step support against the 2x4 flush with the top of the riser, gripping firmly to keep it aligned, then drive the screw into the pocket to join the support to the panel (see picture at left). Reclamp the panel against the 2x4 to attach the center and top step supports, as well as the back brace.

Now attach the second side panel, using the same screwing jig. (If your drill is large, borrow a small one – or use a screwdriver – to more easily get inside the workpiece.)

Center each tread across the steps, drill pilot holes, then nail the treads in place with #6 finish nails. Use a nailset to sink the nails

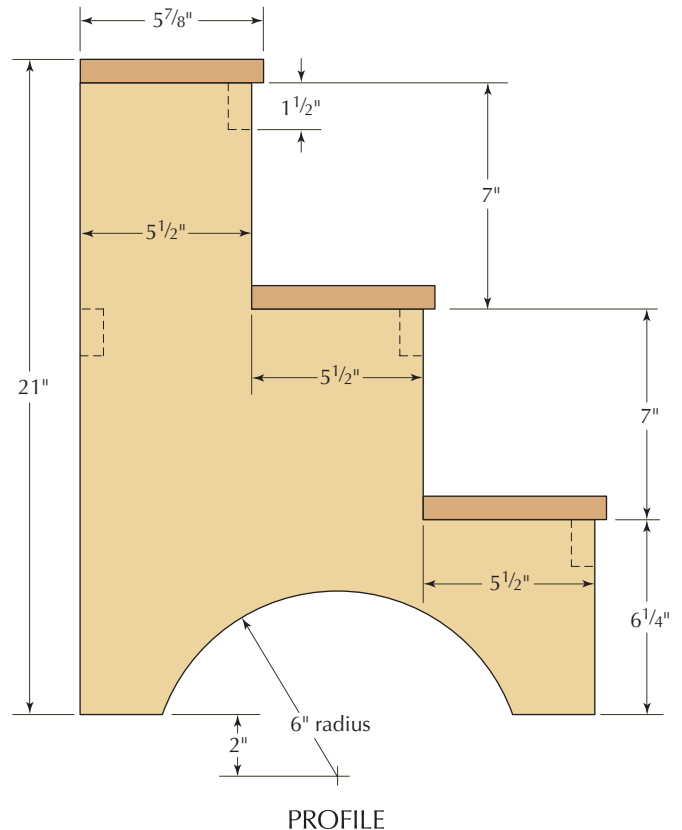

below the tread surface, then fill the holes with wood filler (or spackle), and let it dry.

Once the filler is dry, sand the joint edges and filler flush. Chamfer the front and side edges of the treads with a block plane to keep them from splintering, and break the back edge with sandpaper. Paint or stain as desired. **PW**

Comments or a question? Contact Megan at 513-531-2690 x1348 or megan.fitzpatrick@fwpubs.com.

About This Column

Our "I Can Do That" column features projects that can be completed by any woodworker with a modest (but decent) kit of tools in less than two days of shop time, and using raw materials that are available at any home center. We offer a free online manual in PDF format that explains all the tools and shows you how to perform the basic operations in a step-by-step format. You'll learn to rip with a jigsaw, crosscut with a miter saw and drill straight with the help of our manual.



Visit ICanDoThatExtras.com to download the free manual.

HYBRID SAWS



Online EXTRAS

For a video of the editors' likes and dislikes on the hybrid table saws we tested for this story, go to:

popularwoodworking.com/nov07



COMPROMISE OR CURE-ALL?

BY TROY SEXTON

The table saw is one of the most important machines in a shop. Should we make room for a new category, or stay with the 'old reliables?'

Hybrid table saws burst onto the woodworking scene almost as fast as hybrid cars rocked Detroit. They've plucked a few characteristics from the contractor saw, as well as some features of the cabinet saw to establish their own identity, and price point, in the middle of the pack. So, will these saws have the same Detroit-type impact on woodworking?

The big step the hybrids have taken above the contractor's saw is placing the motor in the cabinet. No more belts running exposed behind the saw that allow cutoffs or fingers into their path—or wearing prematurely (I've replaced a number of belts on my contractor saws).

With the base enclosed, dust collection is greatly improved, at a reasonable cost. You

attach a dust-collection hose to the 4"-dust port instead of rigging a bag or box under the traditional contractor saw.

If the hybrid is a step above the contractor saw, it has to be a step down from the cabinet saws. That step is in power. Hybrid power is 1³/₄hp to 2hp while the larger cabinet saws have a minimum of 3hp. But, with the smaller motors comes the ability to power the saws on 110-volt electric, another major difference. If your shop doesn't have 220v electric you can move up to a hybrid saw with few worries.

And in This Corner

Popular Woodworking arranged to send me six different saws to get the scoop on them from

inside a practicing cabinet shop. If you're in the market for a hybrid table saw, you can decide if they're the best of both worlds, or if you're compromising and settling for a lesser tool.

Included in the test were the Craftsman 22124, Delta 36-717, General International 50-220C M1, Grizzly G0478, Jet Proshop (708482K) and the Steel City Tool Works 35601. Each of the 10" table saws came with a 30" Biesemeyer or Biesemeyer-style fence and all were listed with a 1³/₄hp motor except the Grizzly saw, which has a 2hp motor.

I'm not going into detail on the setup of the saws or many other common items in table saw reviews. All saws have some quirks. Assembly differs due to a number of reasons. Each of the tables needed some work to level the wings to the tabletop, something most woodworkers have come to expect. However, Steel City added set screws near each bolt location that made leveling the wings a snap. Steel City also packaged the hardware to match the assembly steps.

Another area commonly discussed is the trunnions and how they attach to the saw. Because adjusting table-mounted trunnions has been an issue in the past, manufacturers are focusing on getting correct alignment before saws are shipped. This wasn't an issue during setup, but after a few years, an adjustment may become important. The Steel City and Craftsman saws have the trunnions attached to the cabinet while the rest of the group has the trunnions fixed to the underside of the tabletop.

Power is King

When evaluating table saws I look first and foremost at the power of the saw. That's not to

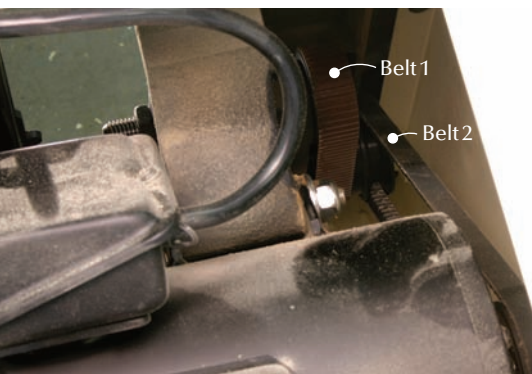

A two-for-one deal. The "two-step pulley system" on the Jet and General saws helps to increase blade speed and reduce overall vibration of the machines.

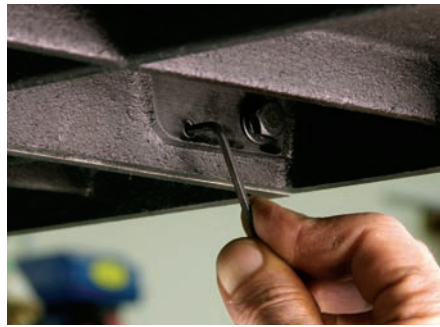

Set up to work fine. Set screws added to the wings of the Steel City saw made for accurate adjustment of the wings. A level tabletop was an easy task out of the crate.

say I read the motor for the horsepower listings. Horsepower is not always an indication of the saw's abilities. There are ways to influence the internal workings of saws to allow them to perform better. Increase a pulley size or tweak a belt and you can effect a change.

To me, the best method for testing power is to make cuts at the saw. I selected 3/4" and 1 3/4" red oak to test each saw's ability. Depending on feed rate and the sharpness of the saw blade, it's possible to bog down lower-power saws as you cut. I kept my feed rate consistent, and each saw was outfitted with a new Freud thin-kerf, 50-tooth combination blade (LU83R010). (All the saws except Grizzly came with a blade.)

None of the saws had difficulty ripping or crosscutting the 3/4" material, but I began to separate the men from the boys when I ripped thicker stock. The Jet and Grizzly saws showed no signs of slowing as the stock was cut, while



Plenty of stops are a positive. The Delta miter gauge rated number one. By pressing the spring-loaded lever you can adjust to any one of 11 positive stops, or locate the pointer to the desired angle setting and tighten the handle for a firm hold. This gauge was snug to the table-saw slot exhibiting no sloppiness.

the Steel City saw exhibited a minute decline in blade speed. The General and Craftsman saws ran in the middle of the pack with the Delta saw a bit below the average.

See How They Run

I gave each saw an hour-long constant-run test. The saws used three kinds of belt systems. The Delta, Steel City and Craftsman use a single belt that's flat and ribbed (called a poly V-belt). The single belt on the Grizzly is short because the motor and arbor pulley are closely positioned. During my test, this machine became hotter than others, which could mean replacing a belt sooner rather than later.

The General and Jet saws use a two-belt system that General calls a "two-step pulley



Best fence, period. The Jet fence was outstanding. It slid like a bobsled at the Olympics. The aluminum fence faces have a T-slot for adding jigs or fixtures. When locked, the fence held tight to the table.

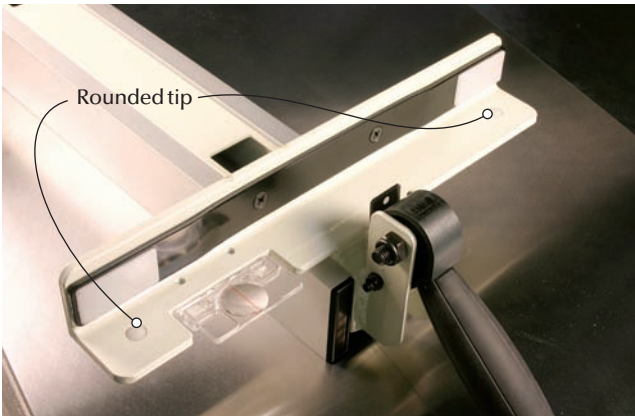

The source of slide. The reason the Jet fence slides so well is the adjustment screws have a rounded tip. That tip makes minimal contact with the front rail to provide a smooth glide.

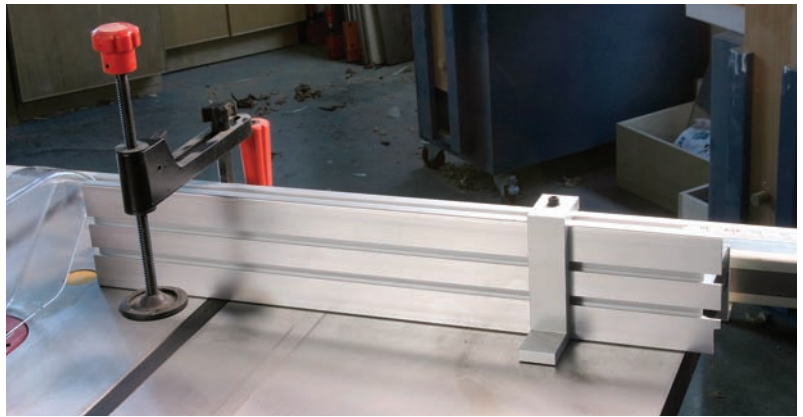

Too many frills? The Craftsman miter gauge is loaded with extra features. I like the aluminum crosscut fence with the extra T-slots, but the other features (such as the hold-down clamp) are not something I look for in my miter gauge.

system.” This provides additional power by increasing blade speed through gearing and allowing the saws quieter and smoother operation by cutting vibration. All the saws passed the test of balancing a nickel and penny on the table in start-up mode, with only the Delta saw dropping the penny as the motor was shut off.

Fence Systems Come Next

After power, I looked at the fence systems. Each saw has a similar fence, but there are differences. The Craftsman and Delta saws have a true Biesemeyer fence. There are adjustments to align the fence with the blade as the fence rides on 3/4" x 1 1/2" glide pads resting on the front rail and table surface.

The Steel City saw had its “Deluxe” T-square fence system. It’s very close to the Biesemeyer in design, but the fence faces are UHMW plastic instead of the laminate on the Biesemeyer. This fence also has the right/left adjustment to align the fence parallel with the blade.

The General fence is a close cousin to the Biesemeyer as well. General added a small post to the end of the fence that rides along a rear rail. This setup provides smooth operation due to the fence riding just above the table’s surface. Attention is needed when installing the rear rail because there’s no adjustment to this post.

The best fence system I tested is on the Jet. With a post riding the rear rail, it looks like the others. However, the most striking characteristic is the way it glides almost effortlessly along the rails. I found that the Jet doesn’t have pads, it has adjustment screws with rounded tips that have a smaller contact area with the front rail.

These screws allow for tilting the fence to perpendicular to the table surface and with the standard right/left adjustment, you can perfectly calibrate the fence to the blade and table. In addition, the fence faces on the Jet are

aluminum with t-track slots in the top edge. I like the idea of having a built-in way to attach jigs to the fence. Finally, when locked in position the fence had great holding ability.

The Grizzly also has four-way adjustment for the Shop Fox Aluma-Classic fence, and the post/rear rail concept. When locked, the holding power rivaled the Jet. The fence faces are aluminum as well with T-track located in the faces. This fence missed the top rating by a nose.

Dust Collection: Improved, But ...

Hybrid saws offer improved dust collection, but improving on the sorry dust collection on contractor saws is an easy hurdle. These machines all have 4" dust ports. The Delta, Steel City, Jet and Craftsman saws have a rear discharge while the General and Grizzly saws have the discharge port on the left.

The General has a full shroud around the blade, with a small hose leading from the blade directly to the dust port, which suggests increased air flow from the blade. But small cut-offs get caught in the shroud and it takes time to remove them. The plastic shroud loosens with three wing nuts, which I found awkward.

The Grizzly has a metal plate just beyond the arbor for improved dust collection. However, the plate makes changing the blade difficult (as does the General shroud) because there is a reduced area into which to fit your hand.

Overall dust collection was as good as in cabinet saws with one exception. The bottom of the saw cabinet on the Jet had open areas around each leg. Of course, those areas can be effectively closed, but is that something you should have to do to your saw?

Little Things Add Up

All the saws have useful features while some have features that are frustrating and weak.

Each has some of both and no one saw is lopsided in either direction. The cumulative information is detailed beginning on page 43.

One feature that I found frustrating was some of the insert plates. A few saws require you to have a screwdriver to gain access to the arbor. Another problem with some plates is thickness. The General and Grizzly insert plates are 1/8" thick without reinforcement below the surface. I found these plates could bend when sawing narrow stock.

General had the best access door; it was large and located on the left side of the base. There’s no question you’ll be able to retrieve dropped

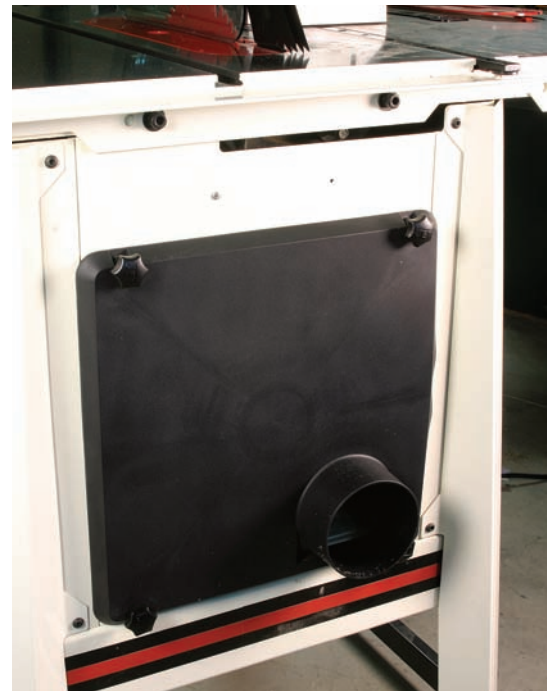

Where are the hinges? The access door on the Jet is not a door – it’s called a “dust hood.” It’s held in place with small lock knobs and is something I’d change if this saw was in my shop.

armor nuts without problem. The Grizzly had a similar cover, but the opening was small, and the Jet required removing four lock knobs to gain access. Others had a hinged access door that covers the motor as the blade tilts.

The Steel City, Delta and Craftsman saws lock both the blade tilt and height adjustment handwheels with inner lock knobs. The others lock the height with that same design, but the blade-tilt adjustment locks with a small lever above the front-mounted height wheel. I found the location difficult to work and too far away from the tilt adjustment handwheel.

Changing of the Guard

A look at the blade guards on these saws shows two distinct designs with three different assemblies. In the first design a tab on the blade guard/splitter assembly fits into a retaining plate positioned inside the opening in the top. This type, found on the Jet and General saws, is easily removed when necessary.

The second design has the blade guard/splitter assembly fitted to the retaining plate, and attached to a pivot shaft and mounting bracket that extends behind the cabinet. Removing a guard of this design requires multiple steps.

With this second design, there are two means of attachment. The Steel City and Craftsman



An all-access pass. The access door on the General was tops. A look inside shows the extra hose attached to the blade shroud that leads to the dust port. That hose robs dust-collector strength from inside the cabinet base, making overall dust collection less effective.

saws have knobs that spin to connect or disconnect the splitter. The Grizzly and the Delta saws require a wrench to disassemble the guards. The Delta guard can be flipped out of the way.

I've always been less than impressed with the blade guard/splitter assemblies on most table saws. In fact, with upcoming changes to regulations regarding table-saw safety and the arrival of riving knives, many of these guard systems could change within the next year.

Too Close to Call One Winner

In my opinion there are two saws that stand out from the pack. Not far in front, but ahead just the same. It's a toss-up, so little features you prefer may influence your choice.

The Jet would be the hands-down winner if the dust collection were improved and the access door was hinged. The power was great and the fence was first-class. Maneuverability of the fence was excellent as was the rigidity when locked to the table.

The Steel City Tool Works saw would gain top honors if the power were increased to keep the blade speed up as thick stock was cut. All other features on this saw came in at or near the top – there wasn't any negative item to weaken its position.



Put the lock where the wheel is. Steel City, along with Craftsman and Delta, has the inner hand wheel locks for both the blade height and tilt adjustments. They're easy to use and conveniently positioned.

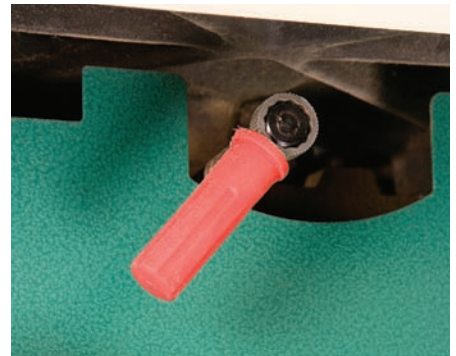

Aggravating lock lever. The General, Jet and Grizzly saws use a lever located front and center to lock blade-tilt handwheel. The location makes these levers inconvenient to use.

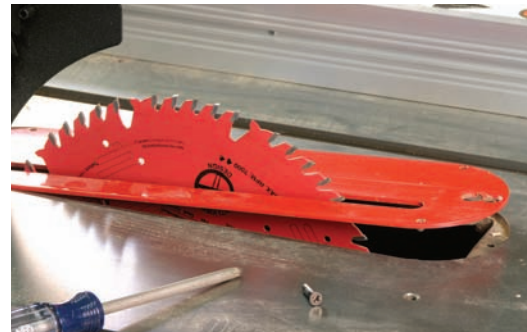

Double jeopardy. Two aggravations are shown on the Grizzly saw. First, the insert plate is very thin at 1/8" and there's no reinforcement on the bottom of the plate. Second, table insert screws require an extra tool close at hand. This saw uses the screw to hold the plate down and flush.



A just-missed design. Looking into the insert area of the General saw, you can see the blade shroud. You can also see the small offset caught in the shroud. A zero-clearance insert would keep that offset out, but neither of the inserts shipped with the saw can.

Picking a "Best Value" would point toward the Grizzly hybrid saw. This saw was near the top in power, had a very good fence system, but took a hit with a few non-user-friendly features. It's a good working saw if you can look past those issues. **PW**

Troy runs a custom furniture-making business in Sunbury, Ohio, called Sexton Classic American Furniture and is a long-time contributing editor to Popular Woodworking magazine.

HOW THE SAWS COMPARE

Craftsman 22124

This saw stands up well in the shop as far as power. It placed in the middle of those tested. The saw, with all the trimmings that are included, looks like a major contender. But the extras were more frill than substance. The miter gauge is tricked out with features I find less than useful, but the extruded-aluminum crosscut fence is a nice addition. The Biesemeyer fence is a stalwart in the industry, but the included rear outfeed table (not shown) was difficult to assemble and use.

800-549-4505 or sears.com



- **Likes:**
 - Biesemeyer fence
 - 22" of table to left of blade
 - Miter gauge crosscut fence
 - Cabinet-mounted trunnions
- **Gripes:**
 - Many poor-performing frills
 - Arbor shaft shortest in group
- **Price:** \$1,100

Delta 36-717

Although it's the lowest-rated performer in the power rankings, the Delta is still a nice, dependable saw. It has a great fence in the Biesemeyer design, and has the best miter gauge of the saws tested. The miter gauge demonstrated no play or slop (side-to-side movement) while in the saw's slot and the angle adjustments of the gauge's fence held tight when set. The only real problem is the motor. It has the least power and the most vibration. Increase the power of the saw and the ranking would move up considerably.

800-223-7278 or deltaportercable.com



- **Likes:**
 - The best miter gauge
 - Biesemeyer fence
 - Good adjustment wheel locks
- **Gripes:**
 - Poor power
 - High vibration
- **Price:** \$1,189

General International 50-220C M1

This solidly performing hybrid table saw has decent power that ranks in the middle of the group. I particularly like the large latching access door located on the side of the cabinet, and it's the only saw that includes a digital display for blade tilting – that's a nice extra feature. The heat generated during the hour-long run test was on the high side of average. The blade shroud makes blade changes difficult and it doesn't improve dust collection. If this is your saw, change the insert plate.

514-326-1161 or general.ca



- **Likes:**
 - The only saw with digital readout
 - Large and accessible access door
 - The idea of the blade shroud
- **Gripes:**
 - Insert plate too thin
 - Miter gauge sloppy and small
 - Blade-tilt handwheel lock
- **Price:** \$869

HOW THE SAWS COMPARE / CONT'D

Grizzly G0478

The 2hp motor rates high with good power, but it isn't enough to offset a number of smaller issues. The ShopFox Aluma-Classic fence has a strong hold when clamped, has four-way adjustment to the tabletop and blade and the aluminum fence faces have a T-track in the face. The insert plate is a big concern due to potential flexing while ripping small stock. In addition, the cabinet access door was too small, making retrieval or repair difficult. I also had trouble with the angle adjustment locking mechanism. It has the lowest price of the saws tested.

800-523-0777 or grizzly.com



- **Likes:**
 - Motor power above average
 - Fence with four-way adjustment
 - Good dust collection
 - Very nice enclosed base
- **Gripes:**
 - Thin insert plate
 - Small access door
 - Guard difficult to remove
- **Price:** \$725

Jet Proshop

The Jet saw ties for best hybrid. It has the most power in cutting all materials. The fence system is the best by far. The ease of sliding the fence along the rails makes this saw a standout. The fence faces are aluminum with T-slots located in the top edge for attaching jigs. Because the enclosed base is so small, you need to keep dust collection hooked up at all times. That, plus a non-user-friendly access panel pushed this saw into a tie for best.

800-274-6848 or jettools.com



- **Likes:**
 - Motor power above average
 - Fence with four-way adjustment
 - T-slots on top of fence rails
- **Gripes:**
 - Poor dust collection
 - Inconvenient access door
- **Price:** \$750

Steel City Tool Works 35601

The Steel City saw ties for best hybrid. It is a solid performer with features that rank in the top three in most categories. The drop in blade speed while cutting 1³/₄" red oak raises concerns about the power of the saw. This alone drops the saw from sole possession of the top rating. If having a reliable table saw is appealing to you, this is the one. There are no frills, but also no areas of frustration. The largest cutting surface left of the blade translates into the easiest panel and miter-gauge cutting of the group. **PW**

615-225-9001 or steelcitytoolworks.com



- **Likes:**
 - Cabinet-mounted trunnions
 - 22" cutting area left of blade
 - Labeled hardware package
 - Good adjustment wheel locks
- **Gripes:**
 - Reduced blade speed in thick stock
- **Price:** \$950

Prices correct at time of publication.

Learn the Skills to be Safe

by Marc Adams

We've all heard the joke about the woodworker in a bar who holds up two fingers to order four beers. Or the one about "What does a woodworker do with the third hole on a bowling ball?"

I can't tell you how many times I've introduced myself as a woodworker and had the first response be, "Let me see your fingers." Why has our craft become known for being so dangerous? Why is woodworking considered as hazardous by those who don't do it? Why do certain professionals such as musicians, surgeons and NFL quarterbacks stay completely away from woodworking? Why is it that tool manufacturers don't help promote safety better – especially because they bear the brunt of liability issues? Or better yet, why don't they require some kind of user-competency test before you can purchase their products?

Accurate and safe. Controlling your stock in a safe manner will also improve your confidence and the accuracy of your results. By learning a few simple rules to work by, you won't be cut by your machinery.



PHOTOS BY AL PARRISH

A Better Way to Work • Part 1

WOODWORKING Essentials

Why has the SawStop met with so much resistance from manufacturers when the technology is so great? What is the real reason that school systems across America have eliminated wood-working classes from the curriculum? Why do some of the most comprehensive books on woodworking not even mention safety? Is safety just not an important issue or is it taboo?

The answer to each of these questions is, simply, “risk.” Safety has always been an issue of defense instead of offense. The corporate world would rather address the issue when it becomes an issue. As a craftsman and educator I choose to take a contemporary approach to safety education: Be aggressive instead of passive.

In my experience, safety is a “skill.” That’s right; safety is a skill, a fundamental in technique, just like cutting a dovetail. It does not occur through happenstance or luck; it happens through planning, understanding and proper execution, just like the “fit” of a tight dovetail joint.

Most accidents occur because of improper techniques, bad habits, haste, fatigue, inexperience and overconfidence. It’s hard to teach an old dog new tricks, but a few simple adjustments in the way you work at each machine, coupled with a few rules about control and exposure, along with understanding that you and the tool both have limitations, can make woodworking (and bowling) enjoyable for years to come.

Before Machines Ruled the Shop

In great-grandpa’s days, before the Industrial Revolution, woodworkers rarely got hurt in the woodshop. That’s right, serious accidents didn’t happen when the user provided the power. You’re thinking, “Now wait – I’ve always been told that a chisel is a very dangerous tool.” But that’s only the case when it is being used or stored improperly. Yes, hand tools have risks – but those risks are minimal in comparison to power tools.

Woodworking changed the day that tools started to rotate under their own power. This rotation and excess power caused unbelievable risks to the user. Old-world craftsmanship had to change; a new generation of wood-



The machine can't think. *Machines offer awesome power, but they also ask something of you. You have to know when certain operations become unsafe, such as when your stock becomes too thin to pass through a standard planer.*

working had to be developed with many new and unforeseen challenges.

Grandpa never had to deal with terms such as kickback, work zone, high-speed cutter, guard, pinch point, feed rate, anti-kickback fingers, splitter, point of operation, face shield, dust collection, ear protection and on and on. For grandpa, woodworking was a human process; today it is both a human and mechanical process. Here’s where the crux lies. In John Feirer’s book “Cabinetmaking and Millwork” he states: “Remember at all times that you must guarantee safety for two: the tool and you. The machine can’t think, but you can.”

As a woodworker and educator I am concerned about the entire aspect of woodshop safety as it relates to the manufacturers, the end user and the techniques they use. Years ago I wrote a letter addressing these issues to every woodworking tool manufacturer. I was asking for help with the distribution of a new safety video that showed proper use of the most common stationary tools. The video won a 2002 “Telly Award,” so the quality was exceptional.

My request was that this video be given, for free, with the purchase of each stationary tool. No promotion, no strings, just pure education. In the letter I wrote, “I know that this issue will cause your attorneys to shudder, your accountants to wonder, your engineers

to question, your safety director to feel uneasy, and your corporate heads to turn. But, it will also cause your customers to take a moment of pause, and realize your position and commitment toward their safety.” No one responded.

During the last four years it has become a quest to find a publisher willing to spotlight a series on safety as it relates to working in today’s shop. The average woodworker today probably took a high-school woodworking class before man walked on the moon, and an awful lot has changed since then – including the 1971 enactment of the federal Occupational Safety and Health Act (OSHA). The purpose of this law was to ensure safe and healthful conditions in the workplace. This act of Congress caused manufacturers, employers and all high school, college and vocational programs to re-think the entire process of hazards in the shop. Their focus on woodshop safety shifted to more on guarding and less on the attention to sound fundamental procedures to using all equipment safely. Although OSHA requirements work well to protect us in the workplace, they have no effect on how we work in our private shops, and I believe this has added to the complacency of safety. Couple in the fact that the only place most woodworkers learned shop safety was from Woodworking 101 in high school (and for some; that was in the day of black-and-white photography).

The purpose of this series is to explore safety for today’s woodworker, explore how specific stationary tools work and why they can bite, kick, throw, grab and pinch – and what we can do to minimize these actions through control and preparedness. Before operating any power tool you must become thoroughly familiar with the way it works and the correct procedures to follow. As you learn to use a machine the correct way, you will also be learning to use it the safe way.

Set the Stage for Safety

It’s not a bad idea to start off with a look at general shop safety. I remember in my old high-school shop class the instructor said that you should always remove your rings and watches before you use any power equipment. It’s a great rule, but

really not very practical. If your hand is so close to something that your ring or watch are going to catch and pull you in then you've already put yourself at risk. I remember the safety speech in high school about keeping your fingers away from the blades on the jointer because they can cut you. What? That was my entire safety lesson! I also remember bits of the other common-sense rules that included: dress properly, watch your hair (not a problem for me today), keep the shop clean, no horseplay, don't carry screws or nails in your mouth, unplug the machine before you make any adjustments and so on. Great common-sense rules, but we need more.

When it came to the technique side of how to use stationary tools, everything was according to the textbook, but it wasn't enough. We were never taught the theory of the machine, the actions of the machine and the results of those actions. We never learned anything about where the control points were to maintain safe handling at and through the point of contact, nor did we learn the best ways to minimize exposure. This is the perfect place to begin safety in today's shop.

Learn This Word: Control

All woodworking machines operate by rotating or reciprocating motion, or by a combination of these motions. Each machine is engineered to provide control that counters the actions taking place – especially at the point of contact. There are three concerns for control at each machine: the direction of the rotating/reciprocating cutter, the position of the wood at the point of contact, and the execution of the movement of wood through the process.

A well-designed machine uses control to counter the kicking and grabbing forces that naturally take place with rotating/reciprocating cutters and provides the user with a clear range of motion through the entire process. For example, a power miter saw does a great job using control to its advantage. The motion of the blade rotates away from the operator toward the fence, which causes the blade to actually push the wood, while being cut, against the control of the fence. At the same time the motion of bringing the blade down into



Good control. Miter saws offer good control points. The spinning blade pushes the stock down and against the fence during the cut.



A safe saw. Band saws also offer excellent control points. The rotating blade pushes the stock against the control of the table, which eliminates the problem of the work kicking toward the operator – as long as the work is supported by the table.

the wood forces the wood down to the control of the table. The point of operation on a power miter box is at the bed and the fence. Because the wood is held stationary during the cutting process, it makes control easy to manage, unlike a table saw. Another great way to describe control is by examining the cut that takes place on a band saw. As the blade rotates downward toward the table, all the force behind the blade is pushing the wood directly on the table. As long as the wood is flatly supported on the band saw table, at the point of contact, there will be no kicking or grabbing because the control is the table at the point of the cut.

Control can also be added to machines by the guarding, hold-down devices, fences, fingerboards, push sticks and other devices. Machine control and ways to create additional control will be discussed with each individual machine throughout this series. But remember this: No cut should ever be made without the use of the control surfaces.

Limit Your Exposure

I like to give two meanings to the word “exposure.” The first is obvious: How much cutter are you presenting at the point of contact? For example: How high should the blade be above the thickness of a board when using a table saw? I’ve lectured at trade shows for nearly 20 years and still shudder at how irresponsible “pitch men” selling blades and saw accessories can be. No guards, no splitter, blades as high as they go.

Face it, we live in a world where “guards removed for clarity” is an acceptable way to work in the shop. That’s just wrong. There is no advantage to seeing the actual cut take place when it causes the user to be at risk. We know what wood looks like when it’s cut. When it comes to how much blade should be exposed, the rule is to minimize not maximize. Like the late Roger Cliffe use to say: “How high the blade should be above your work is a definition of terms, the difference between amputation and laceration.”

The second type of exposure is in terms of repetitiveness. Each time you make multiple cuts or passes you put yourself at more risk. For example there is no sense in making several passes over

a table saw blade to make a wide cut when you could have done it in one pass with a dado blade. As you expose yourself to extra passes or multiple moves, you expose yourself to more risk. Exposure, however, can cut both ways. I believe it is better to make two passes at $\frac{1}{16}$ " on a jointer to remove $\frac{1}{8}$ " of stock rather than to make one pass with an $\frac{1}{8}$ "-deep cut. There will be less blade exposed, less kicking force and if the grain tears out on the first pass, it is easy to correct it on the second pass. This second point of exposure merely causes you to think about the safest way to approach each cut on any given machine.

Three Types of Limitations

There are three types of limitations to consider. The first two are common-

sense: your physical limitations and the limitations of your shop space. Everyone has difficulties handling a sheet of plywood, jointing the edge of an 8'-long board or band sawing the corners off a large tabletop. There is nothing wrong with asking for or waiting for help to arrive. Just make sure that you and your helper work together as a team and if necessary do a dry run of the motions along with body and hand positions before the cut is performed.

Always dedicate one person to guide or direct the work while the other obeys commands – it’s hard to have two people steer a car at the same time.

The second common-sense limitation is determined by the space in your shop. Small shops will require a lot of pre-planning and strategies for large or heavy wood.



Don't overexpose yourself. It's riskier to take five small cuts with a standard-kerf saw blade when one cut with a dado stack will do the job. Unnecessary repetitive cuts expose you to more danger.



The 3" rule. When a cut will take your hands within 3" of the machine's guard, you should use strategies (such as push sticks) that will keep your stock under control and your hands at least 3" away from the guard.

Foolproof Sharpening

No mess, no jigs, just quick, accurate, sharp results.

I hate to sharpen my tools! I love working with sharp chisels and planes, but I've never enjoyed keeping them that way. Part of this animosity may have started when I was a teenager learning to sharpen on a dished-out oilstone in my dad's shop. I learned, but in my woodworking soul I related sharpening to a frustrating, messy and ultimately disappointing process.

It's been 30 years since that time, and I've talked to a lot of woodworkers who have a more positive and almost religious approach to sharpening. Each has shared with me their expertise, their jigs, new sharpening stones and machine technology. And yes, sharpening has become a more palatable process for me. But I still didn't want to do it – until now.

When I was introduced to the Work Sharp WS3000, I was honestly expecting another sharpening machine that, well, sharpened. But I was jaded enough that I didn't expect to find anything that would make me "want" to sharpen. It took about two minutes of listening to how the machine worked to make it sound good. But because my skepti-

cism was so well honed (sorry, I couldn't resist the pun), I immediately set about trying to find out what the catch was to this "too easy" sounding process. I still haven't found it, so let me share this exciting tool with you.

*David Thiel, Editor
Popular Woodworking Books*



First let's look at how easy the Work Sharp system is to use.

I've always fought against keeping the correct angle on the tool's edge while sharpening, and never enjoyed the time required to push and pull a plane iron or chisel across a stone – any stone. A sharpening machine with a blade holder seemed the best answer, but adjusting the holding jig and dealing with the heat and mess of a wet-grinding sharpening machine still made the sharpening process too long and still too complicated.

The Work Sharp product line includes two machines and their accessories. The machines are the WS3000 shown in the pictures here (around \$200), which offers four pre-set blade angles (20°, 25°, 30° or 35°) and operating at 580 rpm. The other machine is the WS2000, which is a more basic machine (around \$100) and offers a set 25° angle for sharpening and a faster (1,750 rpm) wheel speed.

Both machines respond to my issues with sharpening. They have built-in blade guides that quickly (and I mean two-seconds quickly) adjust to fit the width of your plane iron or chisel. The WS2000 will hold blades up to 1 5/8" wide, and the WS3000 accommodates blades up to 2" wide. A lever to the right of the port allows adjustment for the blade skew to guarantee a square edge on your chisel or plane blade.

Focusing on the WS3000 model, sharpening is accomplished with four grits (more are available) of self-adhesive discs that are adhered to two 150mm tempered-glass wheels. The wheels can be used either side up in the machine, which allows four progressive sharpening grits without having to change the adhesive discs.

The guide holds the blade loosely to allow a plunge-and-pull motion that touches the bevel edge of the blade against the underside of the spinning glass wheel. Here's where the guide gets even better. The resting surface of the guide has a micro-abrasive sheet that removes the burr created during sharpening, as the tool is withdrawn!

Sharpening creates heat that can damage the temper of the iron or chisel. Wet sharpening systems use the liq-

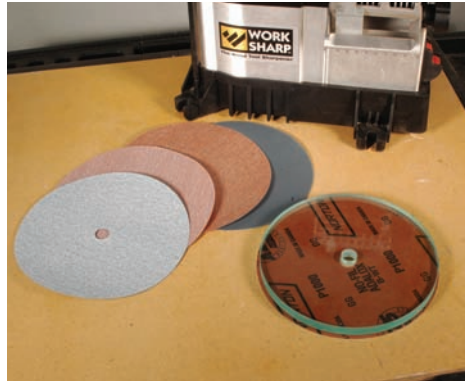

1 The WS3000 is equipped with two tempered glass wheels and self-adhesive abrasive discs in #120, #400, #1,000 and #3,600 micro-mesh.



2 The glass plates with the four graduated grits attached go on and off the machine in seconds using the simple top-mounted knob.

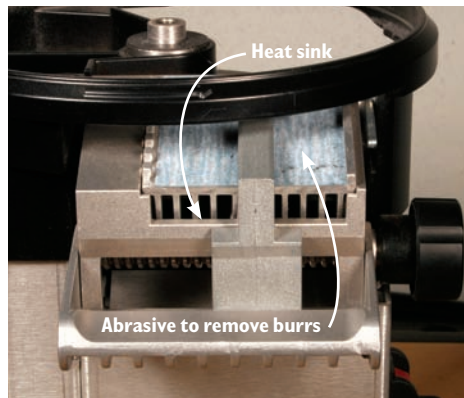

5 The blade guide also serves as a heat sink to pull heat away from the blade as it's being sharpened, protecting the blade's temper.



6 If you've done any sharpening, you know a flat back is important. Simply rest the back edge of the blade near the edge of the plate to start.

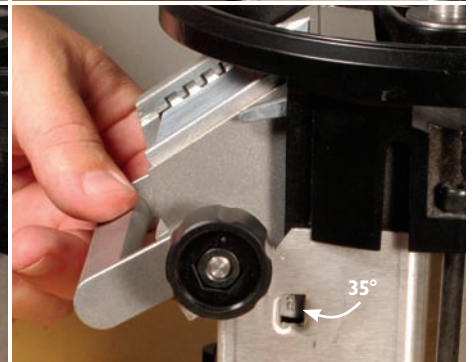
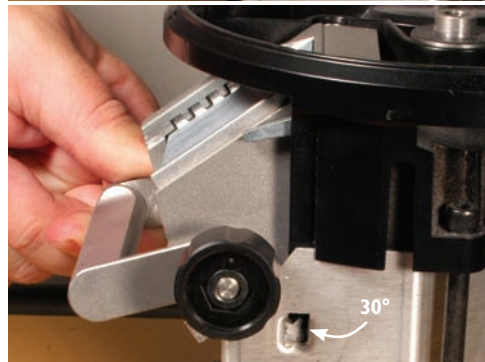
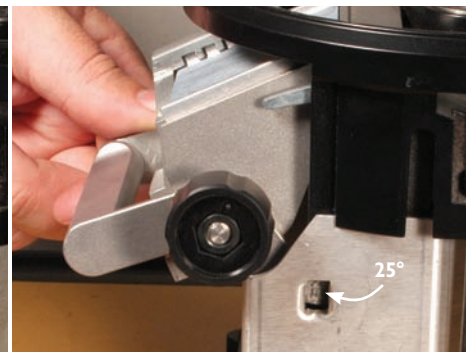
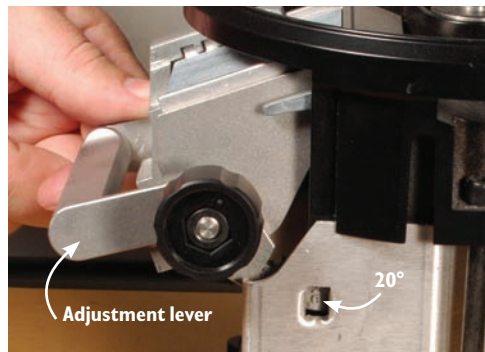

The blade angle on the WS3000 is adjusted by lifting the lever and moving the guide up or down. The window on the side shows the angle. The WS3000 offers four different sharpening angles, 20°, 25°, 30° and 35° for different blade requirements.

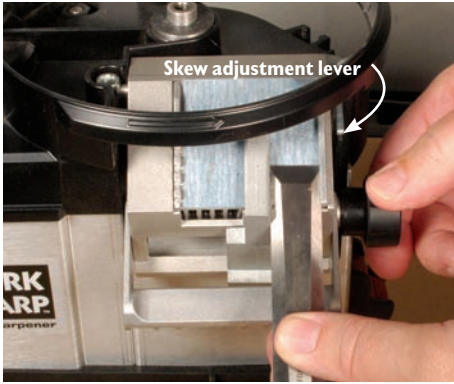

3 To adjust for the width of the blade, simply set the blade in place in the guide and adjust the left stop by turning the knob at the right.

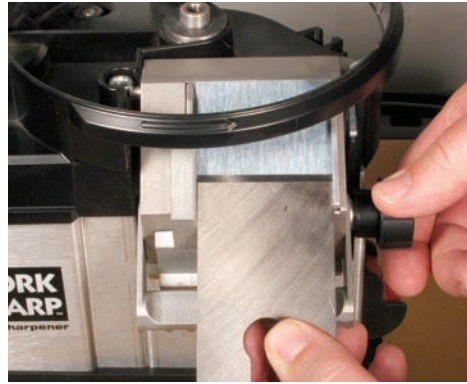

4 The guides will accept blades up to 2" wide. The fit should be snug, but it needs to be loose enough to allow the blade to slide up and back.



7 By gently rocking the blade forward, it takes very little time to achieve a flattened back to your blade. You'll likely only need the #120- and #400-grit sheets for this step.



8 Sharpening the beveled face is a simple one- or two-second plunge forward, and a pull backward to remove the burr. Simply repeat through the four grits to achieve a perfect, sharp blade.

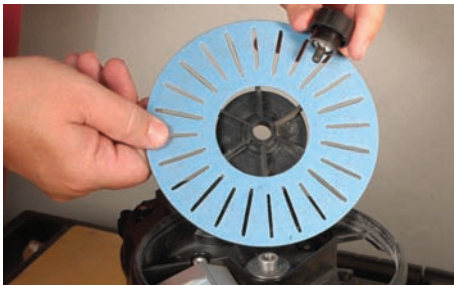

The slotted Edge-Vision disc and matching self-adhesive abrasive sheets attach as with the glass plates, and with the abrasive side facing down.



Looking through the Edge-Vision slotted disc while it's spinning, you can easily sharpen curved tools such as this turning gouge.



For blades outside of the range of the tool guide, a top-mounted toolrest allows for freehand sharpening on the top of the plate.



And Work Sharp isn't only for woodworking tools. Hatchets, garden tools and more can be safely and accurately sharpened.

uid to keep the tool cool. But the Work Sharp port is designed to function as a heat sink to pull the heat away from the tool as air is channeled around the port. Both these features make it possible for you to pull the blade out and touch it without any significant heat buildup. That's cool (literally).

Experienced sharpeners know that the back of a chisel or plane iron needs to be flat for the bevel face to be sharpened correctly. With the Work Sharp, flattening the back is easily accomplished using the abrasive surface exposed on the top of the two-sided wheel.

With the back of the blade flattened, and the bevel angle adjusted, a plunge-and-pull motion touches the bevel edge against the abrasive disc, rapidly achieving a primary bevel. By changing the abrasive discs you quickly work up through the grits to a final razor edge.

If you're a woodworker who likes a secondary bevel on your tools, simply readjust the tool-guide angle and with a few more touches against the wheel, you're done.

Turners and carvers work with tools that have curved edges. The Work Sharp is still the machine for them. A slotted disc replaces the glass wheel and allows sharpening of shaped edges, also from the underside of the disc. But in this mode you can actually look through the Edge-Vision disc and see the edge of the tool as you sharpen it!

Of course, not every blade works perfectly in preset guides, so an adjustable-height toolrest at the top of the Work Sharp allows for freehand sharpening. And that ability makes the Work Sharp a good sharpening system for non-woodworking tools as well. Whether it's an axe in the tool shed or a mower blade from the garage, all can be sharpened on the Work Sharp. I'm sold!



CUTTING EDGE TECHNOLOGY

NEW!

from the makers of

Drill Doctor®



*The revolutionary
Edge-Vision™ Wheel
lets you see the
cutting edge as you
sharpen!*



WS3000

Innovative Sharpener for Fine Woodworkers

- WORK SHARP 3000 sharpens and hones wood tools to professional tolerances
- Easy to use, no jigs needed
- Air-cooled dry system, no wet mess
- Sharpening Port insures precise repeatable angles—20°, 25°, 30°, and 35°



WS2000

Precision Benchtop Tool Sharpener & Grinder

- WORK SHARP 2000 grinds and sharpens bladed tools from putty knives to axes
- Easy to use, no jigs needed
- Air-cooled dry system, no wet mess
- Sharpening Port insures precise repeatable 25° bevel angle



**Precise repeatable
angles without jigs!**



See both award-winning new
Work Sharp models in action online at
www.worksharptools.com
Or phone 1-800-597-6170

The third limitation, which is definitely the most important limitation to understand, is what each machine is capable of doing or not doing. Every machine has a limit as to the size of material that it can cut or handle safely. It's important to understand that there is always an alternate way to cut, size, shape, dimension and sand wood.

Some machines have very defined limitations while others don't. We automatically know the width, depth and thickness limitations of a planer because the bed is only so wide and can be adjusted up and down only so much. When using a planer, you have to know when a board is too short or too long. You have to know the proper feed rate for the depth-of-cut. And you have to know to what thickness stock can be planed before you need to add a carrier

below your stock before the knives become dangerously close to the cast iron bed of the machine.

Other machines have equal concerns. You just can't go to a jointer and safely joint a board that is only 3" long or cut a 1" cube in half on a power miter saw. One common-sense guide to the limitations of any machine is if you don't feel comfortable before making a cut, or if any safety device has to be removed or altered, then let that uncomfortable feeling be your guide. Search for another method of cut. Each tool has limits and most often those limits are not listed on the front of the machine. It is a great idea to establish some guidelines to follow, such as my 12" and 3" rule. This will easily help you determine when you are working beyond the capabilities of each machine.

The 12" and 3" Rule

The 12" and 3" rule should always be addressed at every machine every time you use that machine. This rule should be the Golden Rule of shop safety. No exceptions. If you are ever in doubt about the control, exposure or limitation of any machine, this rule will clarify and establish boundaries to make its use safer. Because it is a two-part rule it is best to explain each one individually.

The 12" part of this rule states that if your wood is less than 12" in length, you should pause to ask yourself if it is too short to safely run through this machine. For example, a board shorter than 12" might be too short to run through a planer, but long enough to cut on the band saw or power miter saw. The 12" rule is just a way to evaluate the risk of short lengths at each stationary machine. The key to determine if 12" or shorter can safely be cut on any machine will also be dependent on the 3" rule.

The 3" rule, which is by far the more important of the two, is a boundary that you should observe: Always keep your hands at least 3" away from any guard, shield, pulley or pinch point. Let me clarify: Your hands should always be 3" away from the front, sides, top and back of any guard on any machine. Because the blade is contained within the guard or shield, that gives you a little extra distance from the cutter. Any time the cut requires your hands to be within this boundary, that's when it will be necessary to use push sticks, hold-down boards or some clever fixture to aid the cut.

Here is how the 12" and 3" rules can work together. Let's say that we have a board that we want to cut in half that is only 8" long. If you choose to cut this board at the chop saw, you can follow the 12" and 3" rules because the hand that supports the wood on the table can still easily be 3" or more away from the shield that covers the blade.

Here's another example: Let's say that we have a board that's 4" wide and we want to rip it in half. Although this cut is within the limitations of a table saw, it will place my hand or hands inside the 3" boundary of the guard. When it comes to pushing this piece of wood through I would definitely use a push stick.



Who's the boss? When you need assistance at a machine, make sure one person is in charge and the other is only following orders.

But if the piece of wood is wide enough so that my push hand can be more than 3" from the guard, I will not use a push stick when ripping on the table saw. I will explain when and when not to use push sticks later in the series. Just as a hint: When using a push stick you surrender a degree of control.

Personal Safety

Even though your home shop isn't regulated by OSHA, it makes sense to observe the same safety rules used in industry to protect workers. You can't do woodworking from a hospital bed, and there is nothing more precious than your health. Personal safety – which includes your eyes, ears, lungs and hands – are priority one when it comes to safety.

I have always worn safety glasses and can't imagine how hard it would be to live in a world without sight. I recommend that you always wear ANSI-approved eye wear while working in the shop. It's also good to have goggles as well as a face shield in the shop for when the chips really fly.

I've always been especially concerned for my lungs and make it a habit to use high-quality dust masks when needed. I recommend the kind that are NIOSH rated for woodshop dust particulate and can be reused from day to day under normal working conditions. I replace these when they start to loosen up and no longer fit properly or when they become so used that they no longer are easy to breathe through.

These "particulate respirators" are not suitable for solvents, oils, resins and finishing. I always use a high-quality NIOSH approved mask that has charcoal cartridges that filter out toxins from finishing materials. It's a good idea to store these overnight in a plastic bag. These masks must be properly selected, based on the contaminant and its concentration level. They must be properly fitted and used in accordance with all the manufacturer's instructions. It might be a good idea to buy this type of mask from an auto parts store that sells automotive paints. Sales people there can help you choose the correct cartridges and show you how to adjust the fit of the mask, plus they can explain the correct way to store the mask and when it is time to change cartridges.

Ear plugs have always been my weakness. I should have used them more often when I first started working with wood – especially with routers. During the last 15 years I have become more vigilant about protecting my hearing and today would not be in the shop without them. You have to choose what works best for you. Some people use the foam ear plugs and some use the ear muffs. Be aware that foam ear plugs have to be inserted properly to work and ear muffs can get awfully hot. There have been times when I have used foam plugs along with ear muffs for extra protection (usually as a way to doubly block out the sounds of my wife calling to disrupt my shop time).

The issue of gloves is important. I definitely recommend that you wear heavy-duty rigger's gloves when handling large timber or stacking wood and when carrying heavy sheet stock such as plywood, particle board or MDF. But I would never wear gloves while using power equipment. Any saw that rotates or reciprocates can grab the glove and pull you into the machine. With heavy gloves you lose tactile ability that is important. Your fingerprints have a sticky quality that's important when pushing a board forward or back.

When it comes to solvents, finishing materials and resins, a good rule is if you stick your hands in it then you should stick your hands in gloves first. Be aware that some solvents and resins affect rubber and latex gloves differently.



Keep away from the guard. Your push sticks and hold-downs should be designed so you can obey the 3" rule. These push sticks look different than traditional ones, but they offer advantages.



Extra protection. For dusty jobs with lots of flying debris, you should have additional equipment in your shop, including a face shield, an effective dust mask and ear plugs.

The field of woodworking has just started to recognize that there are health hazards associated with working with different woods, glues and finishes. By being aware of some of these potential hazards you can better prepare yourself for their contact.

Woods

- 1 Trees produce resins, chemicals, bark and even antibodies to protect themselves from diseases, insects and fungi. These natural safeguards may also have a profound effect on people who come in contact with wood.
- 2 Be aware of allergic reactions to wood. If you develop a runny nose, watery eyes or hives, you should make a note of the type of wood that seems to bring on these symptoms. Contact your doctor and seek some advice.
- 3 If you experience any reaction to wood dust make sure you limit your exposure. Wear a mask.
- 4 Be aware of the mold and spore effects of spalted or decayed wood. Some people have severe reactions to the fungus and spores in these types of wood.
- 5 Do not work with (or burn) treated lumber in your shop. This wood may have been treated with creosote or arse-

nic. This stuff is for the outdoors.

- 6 Man-made or composite boards (plywood, particleboard, MDF and laminates) contain resins that can be hard to breathe and can also be eye irritants. Although we cannot eliminate these products from the shop, it is important that you protect yourself while using these materials.
- 7 Be aware that some woods contain tannic acid, which could be an irritant to some people and can cause your hands to turn temporarily black.

Resins and Glues

- 1 White and yellow glues, as well as hot hide glue, are usually non-toxic, and clean up easily. However, urea formaldehyde (resin glue), cyanoacrylate (Super Glue), epoxy, polyurethane glue and contact adhesives (laminating glue) are all poisonous, and should be handled and cleaned up with care.
- 2 When you use resin glues, cyanoacrylate, epoxy, polyurethane glue or contact adhesive, you should wear gloves and a dust mask. After you apply the glue, make sure you immediately clean up any spills or drips. Do not let these glues get into your eyes, nose or mouth. Each glue cleans up with a different type of solvent, so make sure you know what the solvent is and that you have some on hand when you start mixing or spreading it.
- 3 Always wear eye protection when you are scraping glue off the wood, floor, bench or wherever it is.
- 4 Cyanoacrylate (Super Glue) has a special concern – try not to glue yourself to your project. If you use this glue, keep a bottle of solvent on hand.
- 5 Some glues cannot be mixed on plastics or with plastics. Make sure you learn the correct procedures when gluing anything other than wood.

Finishes

- 1 Almost all woodworking projects need to be finished to protect and preserve the wood. Finishing materials, if used recklessly, can be dangerous.
- 2 Pregnant women and women who are breast feeding should avoid finishing projects. Exposure may be especially dangerous during the first three months of pregnancy.
- 3 Correct storage and disposal of

finishing products must be observed. If you are not familiar with what that means you should contact your local fire marshal.

- 4 Most of the finishing products for wood are made with some kind of organic solvents. Most of these chemicals attack the central nervous system, and some can damage the lungs, liver, kidneys and blood as well. They may irritate the skin, eyes, nose and throat, producing acute and chronic effects. The acute effects last only a short time.

An overexposure to high concentrations of finishing chemicals may cause dizziness, shortness of breath, headache, nausea, confusion, lack of coordination and irrational behavior. These symptoms pass as soon as you begin to breathe fresh air. Chronic effects don't pass. They're caused by frequent exposure to low concentrations of chemicals. The effect of each exposure is minor, but the damage is cumulative.

Be aware that some of these chemicals can cause chemical burns. Some strippers contain lye or bleaching agents such as oxalic acid. If you come in contact with these materials, immediately flush the affected part with water for at least five minutes. If the area blisters, especially if it involves the face or hands, you will have to see a doctor.

- 5 Make sure that you protect yourself. To prevent these adverse effects from happening while working with these chemicals, make sure you wear gloves (either rubber or latex), an apron, face shield and an organic vapor respirator.
- 6 Here are rules to follow when working with wood-finishing products:
 - Make sure the area is well ventilated. Open the windows and create air flow that helps remove the fumes from your working environment.
 - Wear a close-fitting air respirator with organic vapor cartridge filters (charcoal filters).
 - And be certain to wear a face shield and rubber gloves.
- 7 In addition to health risks, most of the materials used to finish wood are highly flammable. Here is a list of good housekeeping practices that will help prevent your shop from burning down.
 - Keep all finishing materials in their sealed metal containers. Store the metal containers in a fireproof cabinet.



Good habits. Not only should you have safety equipment in the shop, but you should use it regularly. Always perform operations in the same safe manner. Rushing or cutting corners can get you cut.

- Make sure you properly dispose of rags and paper towels saturated with finishes in either a sealed metal trash can or better yet get them outside your shop and lay them out flat to dry. Disposing of soiled rags in a bucket of water is not a good idea – especially with oily rags.

- Do not wad any rags up when using them or after. Rags saturated with linseed oil may spontaneously ignite. Always lay your rags out flat to prevent fumes and heat from accumulating in the wrinkles and folds.

- It's a good idea to have a fire extinguisher ready just in case.

- Never run a heater when finishing.

- 8 Be careful of how you dispose of finishing chemicals. Dedicate a “satellite” container into which used solvent, paint and stain can be disposed. Check with your fire marshal to determine the best way to dispose of these chemicals. However it is possible to recycle some of the used solvents by pouring them into another container and letting the solids settle out, then re-pour the clear liquid back into another container to use it again. Mineral spirits and turpentine can be use this way. Some solvents can be poured into a shallow pan. This will allow the solvents to evaporate leaving the hard solids, which can then be put in the dumpster.

- 9 Always cover your workbench with cardboard or newspaper to protect it from spills. If you spill on the floor, clean it up as soon as possible.

Preparedness

Woodworking is largely a matter of common sense, awareness and being prepared. Most shop accidents occur as a result of either being over confident, tired or inexperienced. When you work in your shop don't rush; nothing good can come from it. There are no advantages in quick results. Develop a sense of rhythm when working in your shop; this will keep you in tune with what you are doing. Woodworking on power equipment is primarily a mechanical process. As you learn to use machines correctly, you will also learn to use them in a safe way. Remember my statement earlier: “Safety is a learned skill.” Try to always use a machine in the same manner. Do not do it differently from time to time. If safety is a fundamental part of the routine of machining wood, then working wood will always be safer.

I suggest that every woodworker have a safety program or a personal commitment to developing good shop habits. I've prepared a list of 18 rules that should be printed out and hung on the wall. If you ever allow anyone to use your equipment, make sure you review these simple rules with them. To download a copy of these rules, visit popularwoodworking.com/nov07. **PW**

Marc Adams is the founder of the Marc Adams School of Woodworking in Franklin, Ind., one of the largest woodworking schools in the world. For details, visit marcadams.com or call 317-535-4013.

Work with More Accuracy (and Safety) in your Woodshop

The best way to use your machines is rarely explained in the manual. Find out how to operate machines to get accurate results without sacrificing safety.

- **Part 1**
Learn the Skills to be Safe

The groundwork for a lifetime of accurate woodworking is to understand your tools.

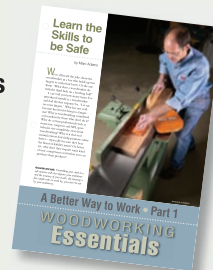

IN FUTURE ISSUES

- **Part 2**
Practical Safety Devices

Choose the right guards, push sticks and hold-downs to work safe.

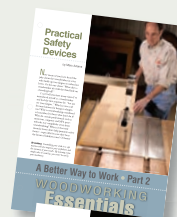

- **Part 3**
Power Jointers

Most people use their jointers wrong, resulting in warped stock and unsafe operations.

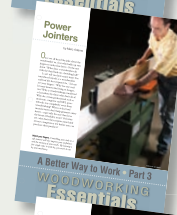

- **Part 4**
Miter Saw

Stock miter saws are neither accurate or safe. Here's how to fix both problems.



- **Part 5**
Band Saws

Band saws are safe if used correctly; however it's easy to step over the line and get bit.

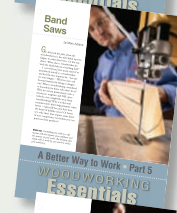

- **Part 6**
Planers

Powered planers seem like a safe machine until you start testing their limits.



- **Part 7**
Table Saws

The fundamental skills to get good (and safe) results with the most important woodworking machines.

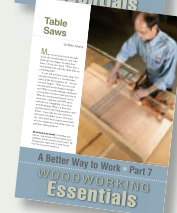

A man in a grey t-shirt and blue jeans is working in a workshop. He is using a large wooden workbench with a custom-built wooden jig. The jig has a vertical board and a handle. He is holding a piece of wood against the jig. In the background, there are various tools hanging on the wall, a framed picture, and a whiteboard with diagrams.

UPGRADE Your Workbench

Online EXTRAS

For a video of Rob demonstrating some of his jigs, visit: popularwoodworking.com/nov07

Steady now. Clamping wide stock for dovetailing can be tricky on some benches. Solve this problem with an easy fix.

Simple and ingenious jigs
that will unlock the full
capacity of your workbench.

BY ROB PORCARO

The most important tool in my shop is one I never pick up: the workbench. I purchased my bench about 25 years ago, a classic continental-style model with a trestle base, a wooden face vise and an end vise with a row of square bench-dog holes along the front of the work surface. Though it has served me well and I'd buy, or more likely make, the same style bench (bigger, of course) if I had to do it over again, I've made significant adaptations to it to get my work done efficiently. I don't consider this a shortcoming of the basic design. It only means that this tool can, and should be, personalized just like almost all other tools to meet the demands of one's work.

Problems arose in holding boards that were long and/or wide and in managing thin, narrow strips of stock. The face vise would rack when tightened down with a board occupying one side of the jaw. I also needed a place for moveable lighting without losing work surface. The

heavy steel bench dogs proved to be overkill for almost all my work and were menaces to edge tools. I also needed, of course, accessories for shooting edges, trimming tenon shoulders and assorted small trimming tasks.

The following bench modifications are easy to make and don't produce major irreversible scars to your bench or fight the time-honored basic design. The alterations use some modern materials, most notably aluminum T-track. While retaining great respect for designs evolved over centuries, we can continue to improve upon them.

Some basics first, however.

The height of my bench is adjusted with blocks screwed to the base to allow the heel of my hand to touch the benchtop with about a 135° bend at the elbow. I chose this criterion for height by trial and error in various bench tasks. A height of 35" works for me. Nonetheless, having an adjustable-height stool available has been a great help in relieving the strain of standing all the time.

A plywood shelf screwed to my stretchers is loaded with heavy items such as a machinist's vise and a granite surface plate to add at least

100 pounds to the bench. I also covered the base where it contacts the floor with high-friction tape. Even on a varnished shop floor the bench, while not massive in dimensions, is amazingly stable.

Hold Wide Boards in Your Face Vise

My toggle clamp sled allows me to secure a board of any width to work on its end grain, such as dovetailing. To make this jig, first install T-track into a groove routed in the front edge of your benchtop. (It is helpful to

handplane this front edge straight and square to the top.) A toggle-cam clamp is screwed to a sliding wooden carrier which is set in place along the track with a standard 1/4"-20 hex bolt and a plastic star knob. Leave some clearance at the end of the groove so the bolt head can enter the track.

To use the sled, secure a wide board on its left side with the jaw of the face vise and on its right side by the toggle clamp. This makes for a solid hold across the width of the board, keeps it flat and greatly reduces vibration



For the long stuff. This jig clamps into my tail vise to help me hold long work. The toggle clamp sled slides in the T-track to adjust for different widths.



The jig in action. The crosspieces at the top of the jig keep it in place as I tighten the tail vise. Then I just slide the toggle clamp sled in position.



When your work is wide. Many benches struggle to secure wide stock so you can work on the ends. Some T-track, a toggle clamp and a star knob can fix that problem.

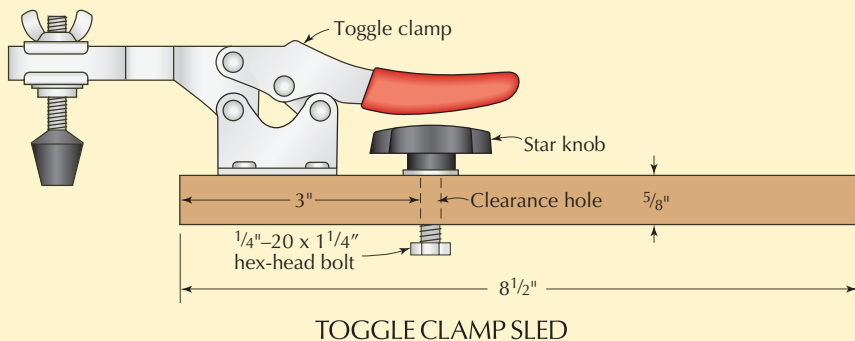

when sawing. This also works very well for holding a frame-and-panel door to trim its edges or ends.

Work the Edges of Long Boards

To work the edges of long or wide boards, I made another jig that uses T-track and my toggle clamp sled. This jig clamps into my tail vise. To make this jig, install T-track into a 1½"-square by 26"-long piece of a dense hardwood (I used bubinga). Screw in crosspieces at the top as shown in the photo to easily and securely fit the jig into the tail vise. The sliding toggle-clamp carrier is inserted into the track and can be adjusted to support the bottom edge of a long/wide board whose other end is held in the face vise. Tightening the toggle clamp then prevents lateral movement and vibration of the long board.



The vise and its wedges. Here's the jig before it goes into the tail vise. The different wedges are used for workpieces of different thicknesses.

Wedge Vise Holds Small Pieces

Working on thin or narrow stock can be difficult and that's when I turn to my wedge vise. This jig is a 1" x 4½" x 2¼" block with a 5/16"-deep recess in the top, angled 1:7 on one side. I clamp it in my tail vise with some of the recess proud of the top surface of the bench. Then I tap a wedge of appropriate thickness into place to secure pieces that are thin, narrow or small. These pieces can be otherwise difficult to hold or may move when planed against a simple end stop. The photo below left shows a narrow, thin, long piece of mahogany solidly held in this device. Note the removable spacer, secured by a single screw, which allows for a range of workpiece widths.

Magnetic Vise Blocks Stop Racking

Face vises are prone to racking if work is held at only one side. This simple spacer system uses a crosspiece with a rare earth magnet inset and epoxied into it. This forms the top of a "T" to hold the spacer block below it, which

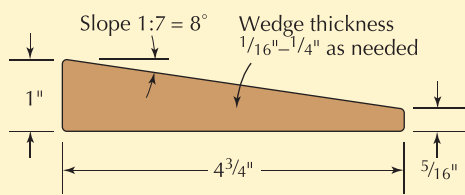

WEDGE PROFILE

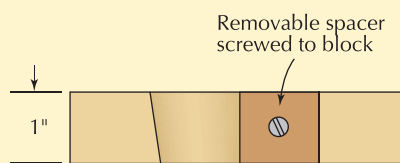

PLAN

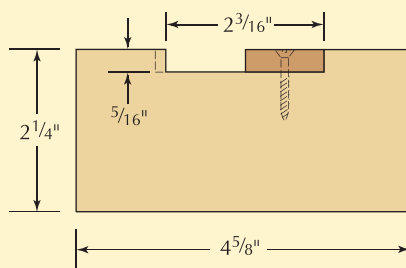

ELEVATION

WEDGE VISE

has a steel screw in its end grain. It takes little storage space to keep a bunch of spacer blocks of various thicknesses. Best of all, it's easy to just hack off an extra piece of the stock you are working on, sink a short flat screw in it, pop it on the crosspiece, and you've got a perfectly sized spacer.

Simple Lamp Brackets

Bubinga (great shear strength) blocks are screwed into recesses at each side of the bench. A hole in the block holds a sintered bronze sleeve bushing, 1½" long, ½" side diameter

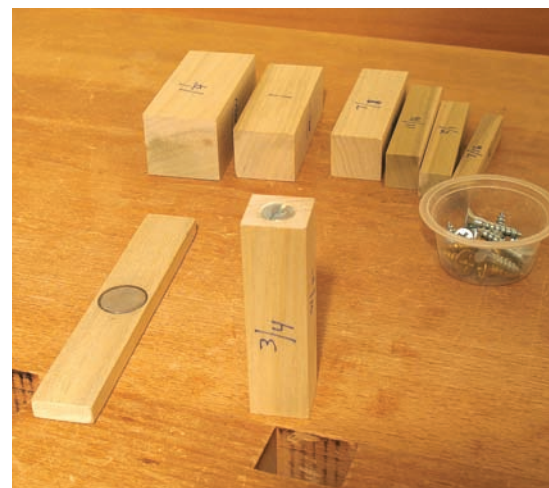

Better than a vise block. Instead of building a bunch of vise blocks for all the thicknesses I have to clamp in my face vise, I use a magnet embedded in a piece of wood as a crosspiece for a bunch of spacer blocks.



No racking, no falling. The crosspiece with the magnet rests on top of the benchtop and vise jaw. The appropriate thickness of spacer block hangs below it thanks to the magnet and screw.



The wedge vise in use. One of the beauties of this jig is that the more you push on the work, the tighter it is secured in the jig.



Add mounts for swing lamps. These blocks are notched into the tool tray of my bench. The bronze sleeve accepts the post of a swing-arm lamp.



Make as many as you need. Position these brackets at a few points around your benchtop and purchase one quality swing-arm lamp. Then just move the lamp wherever you need light.

(ID), $\frac{5}{8}$ " outside diameter (OD) (see supplies box for more information). Drive a small screw in from the side of the block and let the tip bite into the bronze to prevent the bushing from being lifted from the block when the lamp is moved. These brackets allow instant relocation of a commonly available articulating office lamp. The lamp is well supported and rotates freely. These brackets have worked well for more than 15 years without replacement or wear. Buy the lamp, then check the exact bushing size you need.

Spring-loaded Dogs

The wooden springs (typically at a 3° angle) make my bench dogs height-adjustable. The top cross section is just small enough to allow the dog to be buried below the benchtop when desired. The softwood bearing face can be chiseled off every once in a long while when it gets worn and a new one glued on.

Better bench dogs.

The wooden springs on these dogs allow you to use them in high or low positions with ease. The replaceable faces keep me from having to make lots of these dogs.



Shooting Board

The 6"-wide quartersawn mahogany top is screwed, with slots for solid wood movement, to a 9"-wide MDF base; both parts are 26" long. The 3"-wide surface on which the planes rides is covered with $\frac{1}{8}$ " adhesive-backed UHMW plastic. The end grain stop is easily modified or replaced, and the edge of the solid wood top can also be easily dressed as the shooting board is "broken in."

Bench Hook With a Clamp

A cleat below the jig (not shown) holds the device in the tail vise; a toggle clamp quickly secures the work leaving hands free for planing. Overall dimensions are 15" x 9". I use this hook a lot for trimming tenon shoulders. The tenon shoulder butts against the stop, which is secured to the main fence with safely counterbored screws. The red lines are a reminder of the presence and depth of the screws.



Traditional shooting board. This shooting board is clamped between dogs on my benchtop. It can be used for trimming edge grain or end grain with a handplane.

Bench Hook for Both Western and Eastern Handsaws

Nothing fancy here. The stop placed in the middle allows the use of both push- and pull-stroke saws. This also gets plenty of use with chiseling tasks on small pieces.

Additional Lighting

The value of good lighting cannot be overstated. Unfortunately we all cannot have our bench face an open window in the daytime with perpetually bright weather in a wood-working Camelot. Over the bench are bright track lights, two levels of fluorescent lights, and the articulating office lamp. These lights are used separately and in combination to produce the angle, brightness and color rendition needed for various tasks.

What I really seek is a sense of ease at the bench. And that's what these jigs and upgrades are all about. I want the bench to respond to "my hand's mind" as well as allow feedback from the workpiece. I want the work to flow, not be a struggle. **PW**

Rob Porcaro has been a woodworker for more than 25 years; his shop is in Medfield, Mass. You can see his work at pwoodwork.com.

Supplies

Lee Valley Tools
800-871-8158 or
leevalley.com

- rare-earth magnet, 1/8" x 3/4", #99K32.11, \$6.50 for five
- rare-earth magnet, 1/8" x 1/2", #99K31.03, 85 cents ea.
- wing knob, 2" #00M52.01, \$2
- pentagon knob, 2 1/4" #00M50.01, \$1.15

Woodcraft
800-225-1153 or
woodcraft.com

- low-silhouette toggle clamp #143933, \$11.99

Woodhaven
800-344-6657 or
woodhaven.com

- T-track, 48", #4248, \$11.99

Small Parts Inc.
800-220-4242 or
smallparts.com

- bronze sleeve bushing

Prices correct at time of publication.

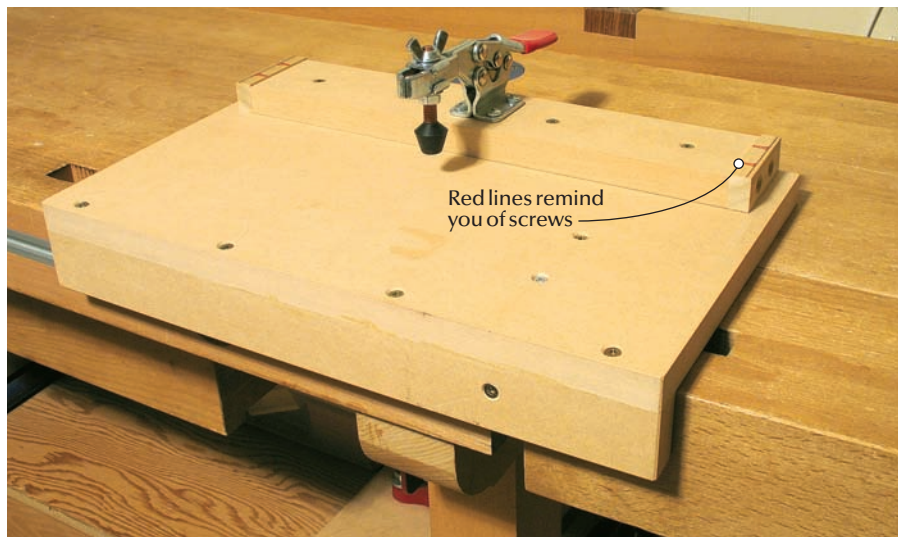

Bench hook with extra grip. When trimming the shoulders of tenons, I like to have my work well-secured. The toggle clamp on this jig will hold my stock while I work the joint with a shoulder plane.



For pushing and pulling. By placing the stop in the middle of the bench hook I can use it with both Western and Japanese saws.



Different lights for different jobs. I have a variety of directional and non-directional lights in my shop so I can turn things on and off until I achieve the result I need to see my work.

GREENE & GREENE: *A Mystery Table*

BY DARRELL PEART



While conducting research for a book, the author encounters a previously unknown table from the workshop of Peter & John Hall.

There is no test more demanding on a piece of furniture than that of time and service. The original example of this library table was made in the shop of brothers Peter and John Hall who were responsible for producing the houses and furnishings designed by another set of brothers: Charles and Henry Greene. This piece has served the Hall family for nearly 100 years and is set to go a second hundred. It has passed all tests and is a tribute to the integrity of those who built it.

Most of us have furniture that we grew up with. The family places great value on this furniture, not as a national treasure, but for its history and service. As years pass, the piece is called upon to serve functions other than originally intended. Its purpose has been to serve, so it does not seem heretical to alter the piece for a new function.

This table was converted into a coffee table in the 1950s; the lower 12", which included the lower shelf, were cut off. To this day the coffee table is still faithfully serving the Hall family and graces the living

room of Peter Hall's grandson. The cut-off portion has also survived.

Mystery of History

The table is solidly in the Greene & Greene style, but it is not known who designed this piece. It does not appear to be an "extra" from any known Greene & Greene project. It is possible that it was designed by one of the Halls. John Hall especially had a creative side and a highly developed sense of design.

It's a real thrill to be in the presence of furniture made by the Hall Brothers, but to be given full access for hands-on examination and the chance to unlock some of the mysteries of the construction is truly heaven. As a by-product of studying the design, I gained an understanding of the designer's intentions – from the different round-overs (and their relation to one another), the arrangement of the ebony plugs and to other things impossible to explain with words.

The Halls used traditional mortise-and-tenon construction. My goal was to emulate the quality of the piece as well as the overall appearance. I kept the look of the piece as close to the original as possible while using sound alternate joinery. I made two versions of this table – one with long legs and a shelf (as in the original library table) and the other the coffee table as it exists today. If you wish to build the coffee table version, simply shorten the legs (see the illustrations) and omit the bottom shelf.

Starting in the Rough

Select material for the shelf and top core with grain match and color in mind. Rough cut the material leaving at least 2" extra in length, and at least 1/2" extra in width. The shelf thickness is critical to joinery later on. If you have access to a drum sander or equivalent – machine the stock and sand to exact thickness after glue-up. If not, be careful when flattening and planing the stock to minimize any tear-out or snipe.

Machine to size all four legs along with all the aprons, stretchers and the four small posts beside the drawer. Leave the ends and lower drawer rails 1/16" heavy in width to allow for cleanup when machining the cloudlifts.

Because the drawer opens from both sides there is no real back to the piece, but to keep the legs in order I arbitrarily assigned one.



Unexpected treasure. A visit to Peter Hall's grandson turned into a surprising discovery – a previously unknown piece from the Hall's shop, converted to a coffee table in the 1950s.

Bunch the legs together in their relative positions and mark them according to their position. Mark an arrow pointing to the center and mark joining lines on the facing surfaces.

Because of their strength and ease of production, I am a firm believer in floating tenons. If you have a method of your own for floating tenons or prefer traditional mortise-and-tenon joints, by all means use it. Be aware though that the lengths in the cut list do not allow for tenons – if making traditional tenons, adjust the overall length accordingly.

I used templates to locate the mortise positions (details online at popularwoodworking.com/nov07). Once the routing templates are made, set up the router with a 3/8" upcut spiral cutter and with a 3/4" template guide. Rout the mortises to a depth of 9/16".

Giving Yourself a Lift

Cloudlifts are a staple of the Greene & Greene style. They are easy to produce, but can be

elusive if you try to shape them entirely by hand. All the cloudlifts for this project are the same size. Start by making a "master" cloudlift template. From the drawing, lay out the cloudlifts on a piece of scrap MDF.

Band saw close to the line, then with a 1/2" spindle on a spindle sander (or a drill press with a 1/2" sanding drum) shape the inside and outside radius. Use the master template to construct templates for the end aprons and the lower drawer rails. Once the curves are machined, place blocks to register the parts and attach hold-down clamps. Remember these parts were left 1/16" heavy in width for this operation. Rout the parts on the router table with a flush-trim bit.

All four legs get rounded over with a 1/4" radius on the edges. The three outer edges are rounded the entire length, the inside edge from the bottom to the dust panel. The rails, aprons and stretchers get a 1/8" roundover on exposed edges. The upper drawer rail, lower



Loose tenons make quick, strong joints. Using a series of templates and a guide collar locates and cuts mortises for loose-tenon joinery.

drawer rail and the drawer side posts all get a $\frac{1}{16}$ " double-stepped roundover. Use #120-grit sandpaper to achieve the second step.

The second step of the upper and lower drawer rails is trimmed to fit the drawer side posts. Use a table saw sled to shave off just the second step so the side post fits seamlessly.

Next, mill the tenon stock to a thickness of just under $\frac{3}{8}$ " and cut the tenons to length,

aligning the grain with the rails. Make them about $\frac{1}{16}$ " less than the combined depth of the two corresponding mortises. Glue the tenon stock into the ends of all the aprons and rails.

How Did They Do That?

With seasonal changes in humidity the solid-wood shelf will expand and contract in the cross-grain direction. The shelf is attached

to support rails in the cross-grain direction and is captured between two legs in the same direction as well. How did the Halls deal with the obvious conflict of grain directions?

This was a question I had when I first viewed this piece. On inspection I noticed both the corner of the shelf and the leg were notched. This gave the shelf the space needed to move between the two legs – unnoticed.

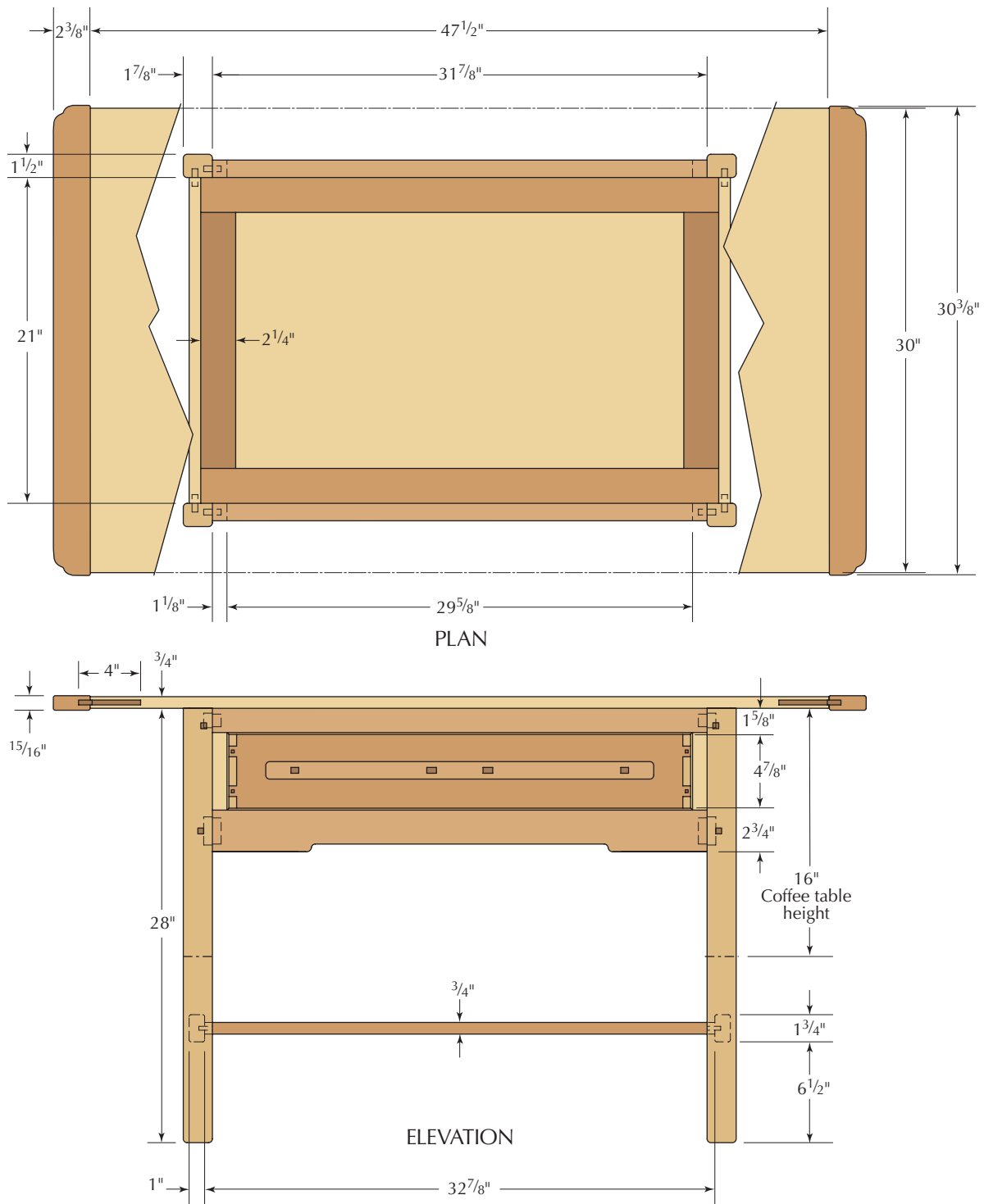

But that did not solve the problem between the shelf and the rails. Looking at the ebony pegs in the shelf rails we get a clue. The outer pegs are wider than the center ones, allowing room for a slotted screw hole. The shelf can move while being held to the rails. The narrower center two holes aren't slotted.

The middle screws hold the shelf fast at the center. With the shelf fixed in the middle, it will move only half as much on either side. Each rail is essentially attached to the shelf as a breadboard end. These methods are clever and effective but the implementation is tricky.

After locating and making the square holes for the ebony plugs, rout a $\frac{1}{4}$ " x $\frac{3}{8}$ "-deep spline slot centered on the back side of the shelf rail. Next drill $\frac{1}{8}$ " holes in the center two plug holes. In the outer two holes center a $\frac{1}{8}$ " x $\frac{7}{16}$ " slot to allow for movement.

The exact dimensions for the shelf need to be determined. In a perfect world this is available from the drawing. The world of woodworking is not always perfect, though. The actual cuts and joinery work up to this

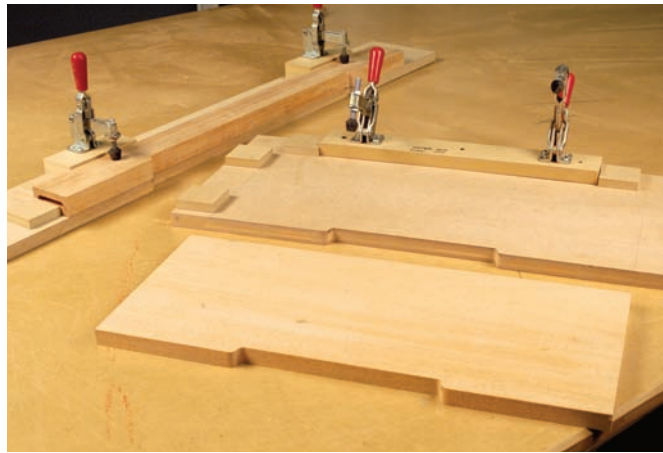

Identical cloudlifts. These pattern templates are used with a flush-trimming bit on the router table to generate matching shapes on the apron edges.



Rails and sideposts. After cutting a $\frac{1}{16}$ "-stepped radius with a router, the remaining sharp corner is rounded over by sanding.



Cutting corners. A portion of the stepped radius is removed at the inside corners of the drawer openings.

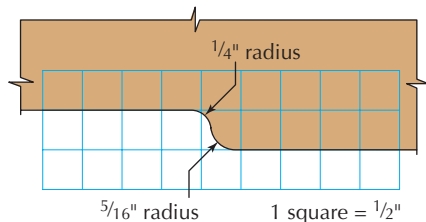

CLOUDLIFT DETAIL

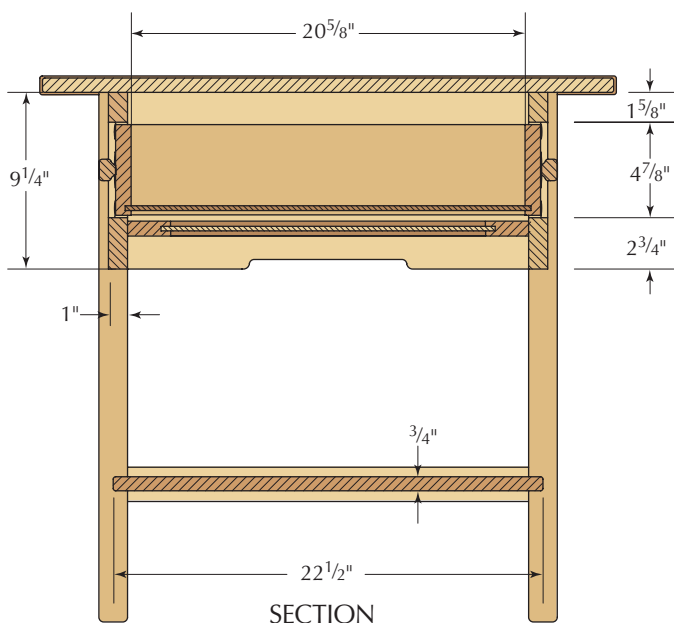

SECTION

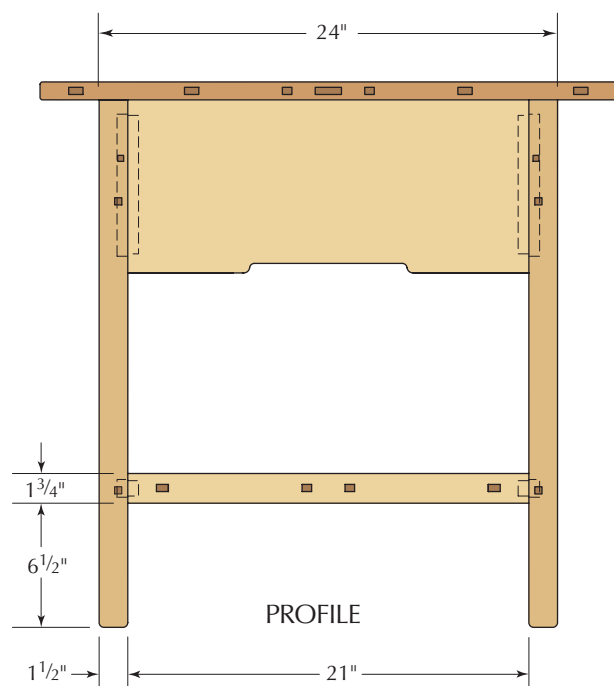

PROFILE

point determine the true length of the shelf and size of its notch. On paper this should be $32\frac{7}{8}$ ". To find the actual length, dry assemble the leg, apron and rail pieces.

The distance between the shelf rails is the true length of the shelf. The length on paper between the notched shoulders of the shelf is $31\frac{7}{8}$ " but the actual dimension is the distance between the legs, which should be the same as the length of the drawer rails. To double-check the measurements, cut scrap wood for a test-fit of each of the dimensions.

Square the shelf then cut it to final length. Save the offcut, which should be about 2" long. Rout a $\frac{1}{4}$ " x $\frac{1}{2}$ " spline cut centered in each end of the shelf. Rout the same spline cut in a short piece of the offcut and cut the notch as seen in the drawing using the dimension from the dry-fit for the distance between the shoulders of the notches.

Next, determine the exact location of the notch in the leg. Dry assemble the left and right sides of the piece. Using the offcut from the shelf and some cross-grain spline material, mark for the notch in the leg as shown in the photo. To ensure that the location of the notch is consistent, make a spacer to register the shelf rail $6\frac{1}{2}$ " from the bottom of the leg. Lay out the remaining lines of the notch according to the drawing.

A simple routing jig produces the notch in the leg. This works by capturing the router base between blocks on either side and limiting the length of cut with another block. This allows the exact location of the router's cut to be visually determined.

Using a plunge router with a $\frac{1}{2}$ " upcut



Two ways to deal with movement. Both the shelf and the leg are notched to help conceal seasonal wood movement.



There's a reason for that. The wider pegs at the outer ends of the shelf rail conceal slots for screws. Under the smaller pegs in the middle, the screws are in holes.

spiral bit, make a test cut with scrap material. Through trial and error determine the correct location ($\frac{5}{8}$ " long rout in leg) for the rear stop block of your jig. Make another test cut to determine the exact depth of cut.

Using the actual leg, make an initial cut centered between the pencil lines and about half the final depth. Make a second cut at full depth. Move the template right and left to creep up on the pencil lines to the desired width. Test the cut with the shelf offcut piece. Once the correct cut is made, square the corners with a sharp chisel.

Next, fit the spline material in the shelf ends. Leave a $\frac{1}{2}$ " gap in the spline wherever a screw will pass. Glue the spline in all the way across the shelf (it will only be glued in the center 4" of the shelf rail). Be cautious of glue squeeze-out around the spline—if hardened it will obstruct a tight fit with the shelf rail

First Subassembly

I like breaking a project down into small and manageable subassemblies. In this case I first assemble the two sets of front legs to the upper

and lower drawer rails and drawer side posts. Before any gluing takes place, all parts are sanded to #220 grit. I like to use a flat torsion box wrapped in butcher paper as a gluing surface to keep everything positively flat.

The floating tenons are already in the drawer rails. If the mortising went as planned, the tenons have about $\frac{1}{16}$ " of up and down movement in the legs, allowing for precise positioning. Line up the upper drawer rail even with the top of the leg. The drawer posts will position the lower drawer rails. Take the time to dry fit and adjust the parts if necessary. When everything is lined up, go ahead with the subassembly.

The dust panel is another case where the size on paper is not necessarily the actual size needed. The width and the length depend on the sizes of parts already made. The listed size will produce a dust panel $\frac{1}{2}$ " too large in both directions. This lets the panel grow if necessary and allows squaring after assembly.

The dust panel's overall width should match the length of the end aprons, which on paper is 21" – defer to the actual length. To

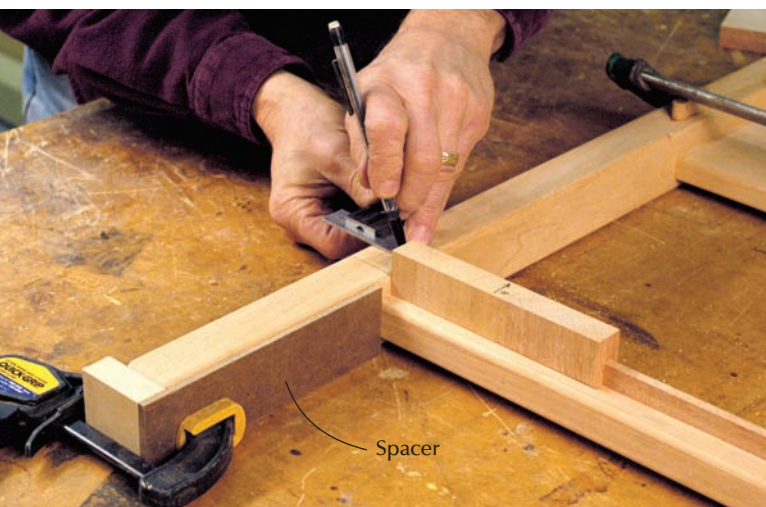

A scrap and a spacer. The exact location of the notch in the leg is marked from the rail using an offcut from the shelf.

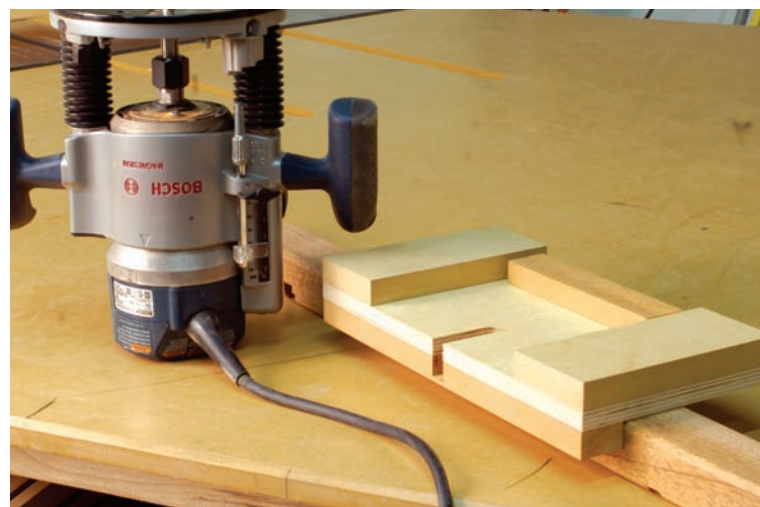

Another jig. This jig traps the router base and provides a way to align the bit with the layout line.

determine the length of the dust panel, dry-fit the two subassemblies to the two ends. The length between the end panels is the exact length of the dust panel. After assembling the panel in grooves in the frame, trim it to final size and machine for biscuits that will attach it to the end apron and the lower drawer rail.

The top of the dust panel is $6\frac{11}{16}$ " down from the top of the legs. The first subassembly gives a reference for that point on both fronts of the table. Lay out and mark for the biscuits.

The Big Glue-up

The moment of truth has arrived. It's time for the big glue-up. This is the point where my excitement level increases. Up to this point it's been a series of technical exercises. What started out as a pile of raw wood is recognizable as something approaching furniture!

The glue-up is broken down into two sub-assemblies. The first joins the dust panel to the two end aprons and the shelf to the shelf rail. Finish sand all parts to #220 grit before assembly. Pre-position all the clamps that will be needed and tape a clamp pad ($\frac{1}{4}$ " material) where you anticipate placing a clamp.

Assemble and clamp all the parts of the table body but only apply glue to the dust panel/end apron joint and the center four-inches of the shelf spline. In the two center plug holes of the shelf rail, run a #8 x $1\frac{1}{2}$ " wood screw to pull the rail tight into the shelf.

Next un-clamp then re-clamp applying glue to all the areas not previously glued. Run



Testing the fit. The end cut scrap is used again to check the width of the notch in the leg.

#8 x $1\frac{1}{2}$ " panhead wood screws with a washer into the two outer holes of the shelf rail.

The Top: Two Kinds of Splines

The breadboard top is an exercise in dealing with seasonal wood movement. In the original, the top has contracted enough to bring the ebony spline inside the edge of the breadboard end. The Halls accounted for this when they built the piece by letting the spline float in the breadboard end. Under the top, metal corner brackets are slotted to allow for movement of the entire top.

Start by cutting the top core to overall size. Mill the breadboard ends to net size—note the breadboard ends should be $\frac{3}{16}$ " thicker and $\frac{3}{8}$ " longer than the top is wide. Rout a $\frac{1}{4}$ " x $\frac{1}{2}$ " spline groove in both ends of the core.

Reset the router depth so the bit is $\frac{1}{16}$ " lower and rout the inside edge of the breadboard ends. This leaves the breadboard end $\frac{1}{16}$ " proud on top and $\frac{1}{8}$ " proud on the bottom. Next lay out and machine the seven plug holes on the exposed end of the breadboard. The three center holes do not need to be drilled for screws, but the four outside holes need to have $\frac{1}{8}$ " x $\frac{1}{2}$ " slots machined to let the screws move with the top as it changes.



All together now. The joinery at the shelf corners is complex, but it will remain strong and look good, making the effort worthwhile.

Lay out and make a full-scale MDF routing template of the breadboard ends and rout the ends to shape. All the exposed edges of the core and end get $\frac{1}{4}$ " radii, except where the breadboard end meets the top. At these points, the radii match the increased thickness of the breadboard. Be sure not to radius the end edges of the core. The spline is glued all the way across the core, but only the center four inches of the breadboard end. Leave a $\frac{1}{2}$ " gap wherever there is a screw.

We are now ready to attach the breadboard end to the core. Use one bar clamp in the center (where the glue is) to draw the two ends to the core. On either side clamp a straight edge caul that spans the core and end and keeps the assembly flat. Because the end is $\frac{1}{16}$ " proud of the top you will need $\frac{1}{16}$ "-thick material to level out the surfaces under the caul. Run #10 x $2\frac{1}{2}$ " wood screws in the outer four plug holes on each end then remove the clamps.

The Exposed Proud Ebony Spline

There is a $\frac{5}{16}$ " x 4" ebony spline that connects the core to the breadboard end. To make the spline, mark a pencil line on the edge of the end, $\frac{3}{4}$ " back from the joining point of the edge and core. Place a pencil mark 4" from the first line onto the core. These represent the placement of the spline. Repeat these markings on all four corners of the top.

With a spline cutter stacked to make a $\frac{5}{16}$ " x $\frac{1}{2}$ " deep cut, rout a slot between the lines, centered on the thickness of the core. With a chisel, square out the rounded corners left by the router in the breadboard ends. Mill stock to fit the slot. It is critical that the stock fit snugly into the slot—but not too snugly. If the stock can be removed from the slot with two fingers—it's just right!

To fit the ebony stock you will have to mimic the inside shape of the slot. I fit the slot with scrap material first then use that as

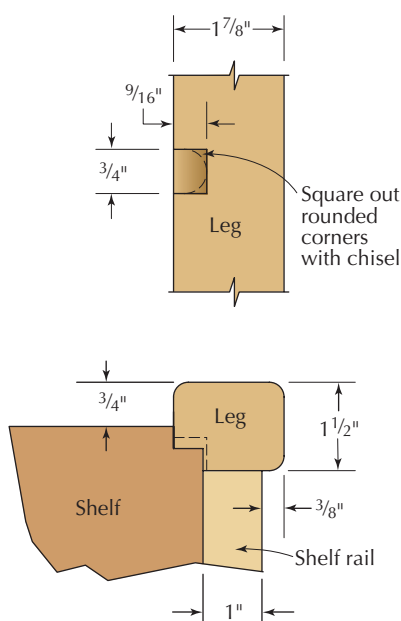

LEG AND SHELF DETAILS

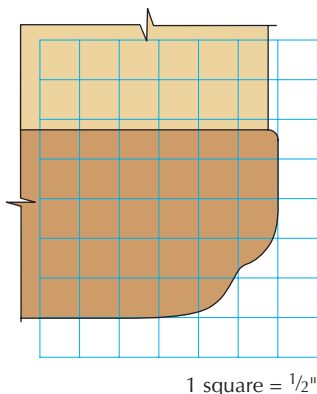

BREADBOARD END DETAIL

a template. To allow for movement the spline floats in the breadboard end side. Where the spline meets the inside of the breadboard end relieve it by about $\frac{3}{16}$ ". This leaves space in the groove when the top contracts.

With the spline fit in the groove use a white pencil or silver gel pen to trace a line about $\frac{1}{8}$ " out from the contour of the top. Waste away the outside of the line on the band saw and glue the spline in the groove, making sure not to glue the breadboard end.

The finished spline stands $\frac{1}{16}$ " proud and

follows the shape of the top. To accomplish this, set a $\frac{1}{2}$ " spiral cutter with a $\frac{3}{4}$ " bearing. Level the top with the material you used for the clamping cauls and rout the spline. Replace the $\frac{3}{4}$ " bearing with a $\frac{5}{8}$ " bearing and rout again. The spline now has points at either end of the groove. Carefully trim these back with a sharp chisel until your fingers cannot snag on them. Make sure the point on the breadboard end side clears the groove. To finish the spline, ease the edges with #120-grit sandpaper and sand out any chatter on the face. Continue sanding up to #400 grit.

Supplies

Lee Valley

1-800-871-8158 or leevalley.com

- tabletop mounting clamps
#13K01.01, \$4.90 bag of 50

Wood Finish Supply finishsupply.com

- English brown mahogany dye
#43, \$5.45 per ounce

Prices correct at time of publication.

The Drawer

The drawer is unusual because it has no back, but instead has two fronts and opens from either face of the table. Before milling the drawer parts, verify their sizes by measuring the openings for the drawer fronts. There is a $\frac{1}{16}$ " reveal around the front so the overall size will be $\frac{1}{8}$ " smaller than the opening.

I first cut a scrap piece of MDF to properly fit the opening. Once the correct size for the drawer is determined, mill the $\frac{13}{16}$ " drawer

fronts and $\frac{1}{2}$ " drawer sides along with plenty of scrap material. (Detailed information on building the drawers is online at popularwoodworking.com/nov07.)

The drawer is supported by upper and lower runners. The lower runners wrap around the bottom corners of the drawer and hold it in place side to side. The upper runners are simple rectangles in section and capture the drawer's up and down movement.

In theory, the corners in these lower runners project $\frac{1}{16}$ " proud of the lower drawer rail and drawer side posts, creating a $\frac{1}{16}$ " gap around the perimeter of the drawer. In wood-working though, theory only goes so far. In most cases a little off here and a little off there makes for adjustments later on.

Place (do not attach) the lower runners, then slide the drawer in place. Center the drawer in the openings on both sides. Make adjustments as needed to achieve an even reveal around the drawer.

If there is too much reveal at the top, shim under the lower runner. If there is too much reveal at the bottom, you may have to remove some material from the runner to compensate. When you have an even gap at top and bottom, place two thicknesses of paper between the drawer sides and lower runners.

With the runners positioned for an even gap side to side, secure the runners with #8 x $1\frac{1}{4}$ " wood screws. Remove the paper and test the drawer for ease of action. The upper runner is actually comprised of two blocks: One $1\frac{1}{2}$ " x $1\frac{1}{2}$ " block that I call the anchor that is glued directly to and flush with the top of the end apron and one I call the adjuster which is screwed (no glue) to the anchor. Once the anchor is glued in place, rest the adjuster on top of the drawer side with $\frac{1}{16}$ " between.

Attaching the Top

The Halls used slotted metal corner brackets to attach the top. For convenience, I opted to use tabletop mounting clamps available from Lee Valley. These are attached to the top with screws and to the body of the table in elongated slots, allowing the top to move.

Using a biscuit joiner (or a router with a slot cutter) cut four evenly spaced slots on the inside of the upper drawer rails and three evenly spaced slots along the upper drawer adjuster rails. The slots are $\frac{7}{16}$ " down from the top edge. With the drawer removed, place the top face down on a soft surface. Align the body of the table and use #10 x $\frac{3}{4}$ " panhead screws to secure the top.



Assemble in stages. Assembling a complicated project goes smoothly when the process is viewed as a series of subassemblies.

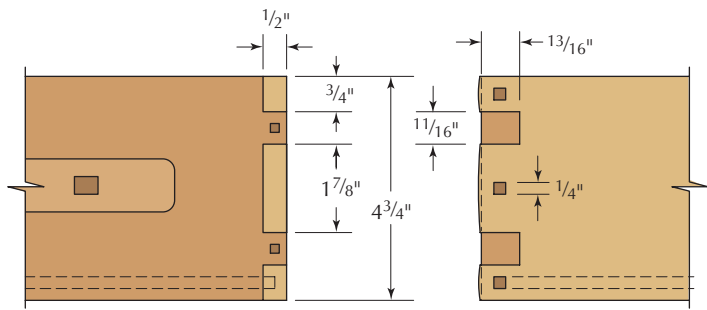

DRAWER CORNER DETAIL



Keeping it tight and flat. The 2x4 caul keeps the face of the breadboard end parallel to the face of the top. Veneer under the caul keeps the surfaces aligned.

The Finish

The finish employed by the Halls used potassium dichromate. It is a dangerous chemical to work with, so I use a water-soluble aniline dye that approximates the original finish.

Go over the entire piece and check for scratches or defects that need repair. Because the dye will raise the grain, the entire piece needs to be whiskered prior to dyeing. Use a damp sponge to wet the surface. When it is dry, sand lightly with #320-grit sandpaper.

For the dye use a one-ounce packet of Liberon English Brown Mahogany #43. Mix the dye with distilled water per the instructions on the packet. Further reduce a portion of the concentrated mixture with 12 parts distilled water.

Apply the dye in two or three applications with a terry cloth-covered sponge. Each application should be light but even. With practice the amount of dye applied can be controlled with hand pressure on the sponge.

For the top coat use General Finishes Arm-R-Seal Satin. The Arm-R-Seal offers good protection and imparts a nice warm low sheen. Each coat is applied then wiped off completely when it starts to become tacky. The trick is to apply several thin coats: four to six coats for the top and three to five coats for all the rest.

If a coat tacks up too quickly and becomes difficult to remove, reapply fresh finish to loosen it up. I use compressed air to blow out finish from the nooks and crannies during the wiping-off process. Allow at least six hours and as many as 24 hours between coats, depending upon the weather conditions.

After the last coat is thoroughly dry, rub the finish out with #0000 steel wool and Mohawk brand Wool-Lube, following the instructions on the container. To complete the finish (again following the instructions on the container) apply a coat of Renaissance brand micro-crystalline wax polish. If the wax hazes up lightly rub out with #0000-steel wool.



Under the plugs. Screws hold the drawer joints together and are hidden when the ebony plugs are put in.

The table is finished! The original has been in service to the Hall family for nearly 100 years. Hopefully, 100 years from now your descendants will proudly display your table in their home. Sign your name and date the table so future generations will know who to thank for the family heirloom. **PW**

Darrell Peart specializes in furniture in the style of Charles and Henry Greene, and is author of "Greene & Greene: Design Elements for the Workshop" (Linden). A photo gallery of his work and the book are available on his web site: furnituremaker.com.

Hall Brothers Library/Coffee Table

NO.	ITEM	DIMENSIONS (INCHES)			MATERIAL
		T	W	L	
❑ 1	Top	3/4	30	47 ¹ / ₂	Mahogany
❑ 2	Breadboard ends	15/16	2 ³ / ₈	30 ³ / ₈	Mahogany
❑ 4	Legs	1 ¹ / ₂	1 ⁷ / ₈	28	Mahogany
❑ 2	Side panels	3/4	9 ¹ / ₄	21	Mahogany
❑ 2	Rails above drawer	1	1 ⁹ / ₁₆	31 ⁷ / ₈	Mahogany
❑ 2	Rails below drawer	1	2 ¹¹ / ₁₆	31 ⁷ / ₈	Mahogany
❑ 4	Posts beside drawer	1	1 ¹ / ₁₆	31 ⁷ / ₈	Mahogany
❑ 2	Drawer fronts	13/16	4 ³ / ₄	29 ⁵ / ₈	Mahogany
❑ 2	Drawer sides	1/2	4 ³ / ₄	22 ³ / ₈	Mahogany
❑ 2	Shelf rails	1	1 ³ / ₄	21	Mahogany
❑ 1	Shelf	3/4	22 ¹ / ₂	32 ⁷ / ₈	Mahogany
❑ 2	Dust panel rails	3/4	2 ¹ / ₂	16 ¹ / ₂	Mahogany
❑ 2	Dust panel stiles	3/4	2 ¹ / ₂	33 ³ / ₈	Mahogany
❑ 1	Dust panel	1/4	17 ¹ / ₂	29	Plywood
❑ 2	Handles	7/8	1 ¹ / ₈	25	Mahogany

Online EXTRAS

For more information about building this project including:

- Drawings and photos for the mortise routing and notch cutting jigs
- Detail photos of the original table

Additional photos and text for:

- Making and inserting the ebony plugs
- Building the finger-joined drawer
- Shaping the bowed drawer pull
- Making and fitting the dust panel

Go to:

popularwoodworking.com/nov07

From *Concept*

■ Part 2

BY TED BROWN



Online EXTRAS

For drawings of this project, go to:

popularwoodworking.com/nov07

Small in size, large on detail. The finished side table is attractive, but unobtrusive. The petite size meets the client's need for a small footprint table suitable to an apartment.

to **Completion**

Detailed drawings, cut lists and grain orientation aid in a successful building process.

We use detailed drawings to capture important relationships between components. It is not always required that we draw the entire piece. If we can draw only the complex parts of the piece, then we save time and effort. I create detailed shop drawings, backed up by dimensioned sketches in my logbook, which can be referred to during construction, or years later. A good example is drawing a section of the legs to show the location of intersecting tenons, the reveal where the apron meets the leg, and the specific dimensions of mortises and tenons.

Shop Drawings

In the shop, it is handy to lay out a shop drawing on a small sheet of MDF. This drawing helps the maker see the overall size of the piece, and relationship between components. The advantage of working on MDF is that it does not wrinkle like paper, so it is easy to work with in terms of taking measurements off the diagram, or placing real parts on the drawing to check for accuracy.

Develop a Cut List

A cut list is required in order to determine the amount of wood needed to complete the piece. As a rule, we want to have at least 50 percent more wood than the cut list calls for before we start the project. We typically waste 40 percent of our wood in cutoffs, jointing, planing, cracks and defects. We also want to saw for grain, selecting rift-sawn 8/4 stock for legs, rift- or quartersawn 5/4 stock for aprons, and flat-sawn 5/4 stock for the tabletop. For these tables the tops are actually quartersawn, which is not as common for a tabletop. The red elm's strong annual rings add a dramatic look to the top.

The cut list is a table that identifies the part, quantity, actual size and the size of the rough billets from which the parts will be machined. If we are making a couple tables with solid aprons, it may be of use to make one extra long apron in case we have unexpected difficulties – this leaves us with an extra long apron, or a short apron. In many cases it is not the wood that costs the most money, but the labor. Setup is a large consumer of time, so consider making extra parts after jigs are completed and machines are set up. In the example below I have added one extra leg, and one long apron. This cut list below is for two other tables with traditional aprons.

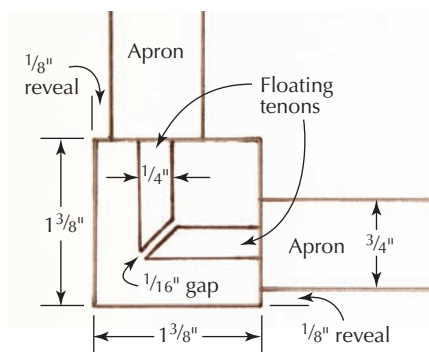

Do they touch? Detail of joinery where aprons meet legs.

When we determine the rough size, we also have to consider machining requirements. Our planer requires a billet at least 15" long to work safely – this is the worst-case scenario, taking into consideration that the part may turn diagonally during the pass. The part has to be long enough so that once it leaves the infeed roller, the outfeed roller is in full contact with the part. Leave your parts extra long to allow an area for test cuts.

Sometimes we deviate from this mechanical approach to the cut list to accommodate wood that we have in stock. Taken to the extreme, we can work backward from the wood in a process we call "Reverse Design," where the graphics and shape of the wood are the primary influences on the design. The available wood then also dictates the possible dimensions for the components of the table.

In the case of the side tables in this design, the tabletop dimensions were determined partly by our desired size from the mockup (see the October 2007 issue for more on the mockup process), and partly by the presentation of the figure in the board on the available pieces of red elm.

Wood Selection

Once you have all of the shape and mechanical considerations in order, the next step is

An Example Cut List for a Simple Set of Solid-wood Side Tables

NO.	ITEM	ACTUAL SIZE (INCHES)			ROUGH SIZE
		T	W	L	
□ 2	Tabletops	7/8	16	24	4 @ 5/4 x 9 x 27
□ 9	Legs	1 3/8	1 3/8	21	9 @ 2 x 2 x 22
□ 5	Long aprons	7/8	3 1/2	20	5 @ 5/4 x 4 x 22
□ 4	Short aprons	7/8	3 1/2	12	4 @ 5/4 x 4 x 15

to look at wood selection. When we make a table, the “face” of the table is the top, thus it should have some visual interest to make the table stand out. Over the years, I have collected wood with an eye to color and graphics. For the two end tables, I selected some quartersawn red elm with sapwood showing, and strong graphics. By trimming the planks, I was able

to use a small amount of the creamy sapwood to create a point of interest in the middle of the tabletop. The strong graphics created by the annual rings support the sapwood center, and work well with the convex curves at the ends of the tabletop.

Care must be taken when coordinating wood colors. In this case, the red elm tops

worked very well with the black cherry I selected for the base.

I added a slight curve along the sides of the top toward the end of the construction process. The edge was straight in my original model, but by adding a slight concave curve, I thought the top worked better visually with the arched aprons below.

Order of Operations

Order of operations is a critical step that most people overlook because they are complacent about their ability to oversee their own work without making timing errors, and/or forgetting key moves. I like to use the analogy of the chess game; it is like writing out all of the moves in a 20-move match. Another way to think of this list of ordered tasks is to think of it as a software program with a main program and subroutines.

Written in your shop log, the “order of ops” has main subject titles in a chronological order, with plenty of space in between for you to add in things you may have overlooked. If you spend a half hour developing this before you start, and then five minutes on it once every few days, you will be much more efficient with your shop time. Instead of coming in each morning and asking, “What am I going to do today?”, and then going through a process of thinking and re-thinking 20 things that don’t need to be addressed today, you simply go onto the next ordered task.

It simplifies your tasks by allowing your brain to focus only on the one task at hand, resulting in clear uncluttered thinking.

So, essentially the order of ops is your global plan on paper, with each sub-section articulated to the degree required to allow you to use this only as crib notes once the action begins. Leave room for additions; this keeps the “program” from becoming cluttered with arrows and micro-writing when you want to insert important steps as you build.

Construction

Now it is time to follow your order of ops, with an eye to sawing wood for graphics and grain. Your order of ops should allow for acclimation time of the wood after you break it out. If you



Use the sapwood. Bookmatched red elm planks became the answer for color and interesting graphics for the tabletops.



Converging grain lines. Top view of completed tabletop.

are resawing 8/4 lumber, you have to plan in several days for the wood to move before you re-flatten it. Keep in mind that it is very inefficient to do only one project at a time. You should have two or three projects on the shop floor at all times. This allows you to rough out the solid wood components for one job, and then give them time to acclimate and move for a week before flattening on the jointer and doing subsequent millwork. One of the most common errors my students make is underestimating potential wood movement, and not allowing enough time for wood to settle.

Make glue-ups simple, with the least amount of stress, and the least potential for failure. Before you glue up, clear your bench, literally spend two minutes to sit down and think through the entire process of construction to ensure you have not forgotten anything, then proceed. To simplify complex pieces, try to break down your project into subassemblies. Be wary of using a large dry fit as a tool to determine if your project will fit together after glue and clamps are added. With the joints dry, they will flex and appear to fit, but when you go to glue up the entire piece, slight misalignments become apparent.

For this table I simplified the process by first finishing all parts before assembly. Then I assembled the end legs to the short aprons. For the next glue-up, I glued the two stretchers that support the floating tabletop (as shown at right) between the long aprons.

The end leg assemblies are dry fitted while the adhesive is setting for the two stretchers. By dry fitting other subassemblies during the curing of the center subassembly, you ensure that the base will fit together square in the final glue-up. For the final glue-up, the long apron assembly is glued to the four legs. For proper clamping pressure, cauls were used on the outside of the legs, cut with the opposite taper to the leg taper. The cauls keep the applied clamping force at 90° to the joint.

By continually clamping up assemblies with their associated dry-fit parts, we maintain the orientation of the parts while allowing ourselves the opportunity to check the entire project for square before the glue sets.

I prefer to pre-finish my parts, wax around the joints on the dry-fit and then glue up the subassemblies. This procedure allows for superior finishing in areas that would otherwise be difficult to access after assembly. The glue squeeze-out simply from assembly sits on top of the wax, which allows for simple cleanup the next day – the glue just pops off.



More details below. Detail photo showing floating tabletop, tension point above the leg, and hand planed underbevels that visually “lighten” the top.



A dowel makes a difference. I used a turned ebony dowel as a focus point where the aprons come together. The “dowel” maintains the spacing between the aprons. All of the aprons were sawn, except the lower end aprons, which had to be steam bent. Steam bending keeps the graphics of the wood in harmony with the shape of the curve.

Try not to exceed four wet joints per glue-up, and you will enjoy uneventful if not pleasantly boring glue-ups.

Finish: Color and Protection

Choose your finish appropriate to the application. In the case of side tables, it is likely that at some point your tables will see real-life action without coasters or place mats. The tabletop will have to be finished with a resilient coating to provide protection for the piece.

I chose to use an oil and varnish mix – it's easy to apply and easy to fix. The oil gives you penetration and deepens colors while the urethane varnish adds a degree of resilience. I applied three coats of a tung oil/double-boiled linseed oil/semigloss urethane mixture. Use #0000 steel wool between coats after a 48-hour drying time to smooth the surface. After three coats of oil and varnish, I like to apply a thin coat of cabinetmaker's wax, then use steel wool on that surface to create a lovely smooth sheen.

Final Assembly

The curved apron assemblies were sawn to shape. The lower end aprons were steam bent to achieve a consistent shape. I chose steam bending for this part to increase strength, and eliminate short grain at the ends of the aprons. I picked angles off of the legs to set the table saw. I made a jig that attached to my crosscut sled with toggle clamps holding the aprons in place while the angles were cut on their ends. Floating tenons were used to attach the aprons to the legs. The hidden stretchers that create the “floating top” were also fastened with floating mortise-and-tenon joinery. The tabletop is attached to the stretchers using screws that pass through oblong holes to allow for wood movement. **PW**

Ted is a furniture designer/maker from Almonte, Ontario, Canada. He is the founder of Rosewood Studio wood-working school (which we wrote about in the August 2004 issue). He now designs and makes fine handmade furniture in a small shop in Almonte, Ontario.



Shaker Oval Music Box

BY JOHN WILSON

A simple gift for the holidays.

Two Shaker accomplishments were prolific song writing (there are more than 10,000 extant songs) and gracefully fingered oval boxes. This music box combines both. The song “Simple Gifts” is familiar to many from Aaron Copeland’s “Appalachian Spring.”

Shaker oval boxes were featured in the August 2003 issue (#135). A set of five nesting boxes was described there, and for those familiar with that set, this music box is the next-to-smallest size, called a #1. For those interested in looking at that article, it is on my web site ShakerOvalBox.com, along with the supply catalog and class schedule for The

Home Shop, which specializes in materials and instruction in this traditional craft.

Making this particular oval box project has been simplified so that fewer wooden forms are needed to get it done. It is expected that first-time box makers will find this helpful. Certainly there is more than one way of doing things, and those familiar with alternatives should choose what suits you best.

Oval boxes are made in two stages: the bending of side bands, and the fitting of oval tops and bottoms. The bending requires an oval plug called a core for bending the hot, wet wood strips for the side of the box, and two oval shapers, or wood corks, to fit into each side to hold the bands while drying. This article describes using a piece of 1" foamboard (used for home insulation) as both the core and shaper. It is easy to make and use, and

scraps of this material are thrown away either from damaged boards at the lumberyard or from building sites. A full 4' x 8' sheet of foamboard costs about \$12.

The bands and top and bottom boards are fairly accessible to those with a woodshop. The dimension of the bands are 1½" x 15" and ½" x 15½". Both are made from wood ¼" thick or a little thicker (.062" to .068"). Thickness is important for both bending flexibility and clinching of the small copper tacks. Cherry is used in this project, but Shakers used hard maple for most of their boxes. Veneer is available in ¼" thickness, and the hard maple is perhaps more likely to bend better than any other species when using commercially sliced veneer.

A band of the size used here that is 1½" wide can be sawn on either a table saw or a

A simple gift. *This Shaker oval box is simple to make, and more than just pretty to look at. Inside is hidden a music works that plays the classic Shaker hymn, “Simple Gifts.”*

band saw. Drum sanders will finish the thin strips to exact size, but a few bands can be worked into shape if carefully sawn without using a thicknessing sander. Your table saw needs a zero-clearance insert at the blade to prevent the thin band from dropping out of sight. You will need something more accurate than your tape measure, however. Use a dial indicator. Flexibility is a function of accurate thickness, straight grain and wood that is fairly fresh that has not been excessively heated in the drying process. If one piece of wood turns out to be brittle, try another. Many different species will bend; hardwoods are generally better than softwoods.

The top and bottom boards are easier to dimension in the woodshop, as the $\frac{7}{32}$ " top and $\frac{3}{8}$ " bottom can be planed. (Check the length of the wind-up stem on your music works before dimensioning your bottom-board thickness. You want the wood slightly thicker than the stem length.)

Part I: Bending the Sides

To bend the wood you'll need to cut the 1" foamboard into the ellipse given in the pattern at right. Be sure to transfer the start mark at the same time to know where to begin bending. Cut the ellipse with either a saw or a knife, and finish with sandpaper over a wood block.

The bands for the box are boiled in water for 15 minutes before bending them. These small bands can be handled in a cooking pot as long as it is not plain aluminum, which discolors cherry wood.

To prepare the bands for soaking, the non-fingered end is feathered with a taper starting 1" from the end. The fingered end is cut and drilled following the pattern above for fingers. Use a $\frac{1}{16}$ " or $\frac{3}{64}$ " drill bit for the copper tack holes. The fingers are trimmed using a utility knife to give the graceful shape with a slight 10° bevel to the cut. Both bottom and lid bands are prepared in this way.

Both the soaking and the heat (above 180°F) are important to successful bending. Bands with reasonable flex are done in 15 minutes, others may require 20 or 30 minutes. And, as mentioned above, some wood no longer retains flexibility for bending. Here, experience and perseverance are needed.

It is important to anticipate the next steps for bending. The thin wood cools quickly, so understand what you will do before removing it from the hot water. The start mark indicates where to begin and the band goes across the front of the oval. Bend the wood, giving

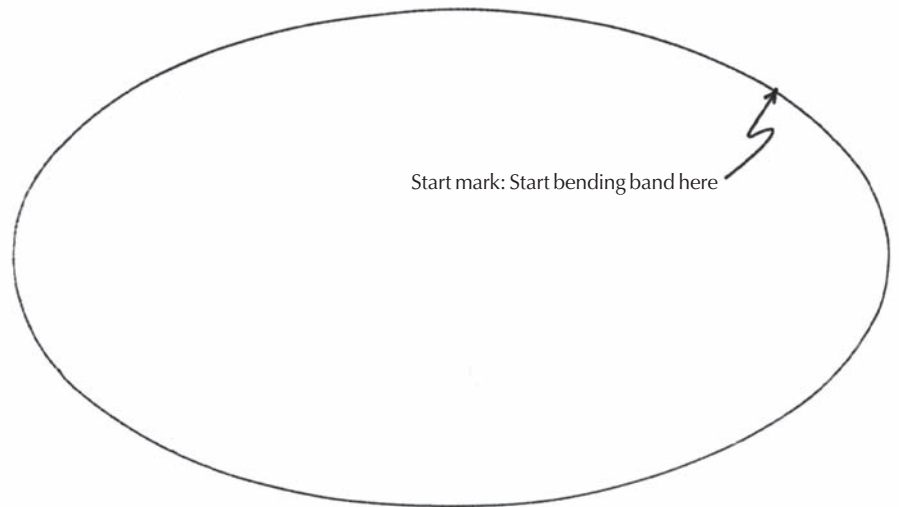
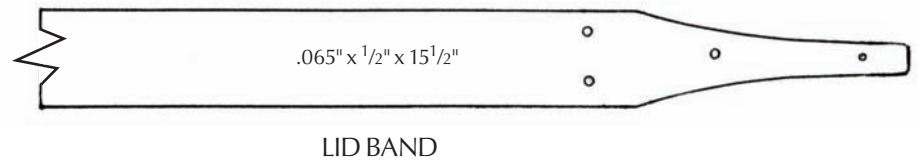
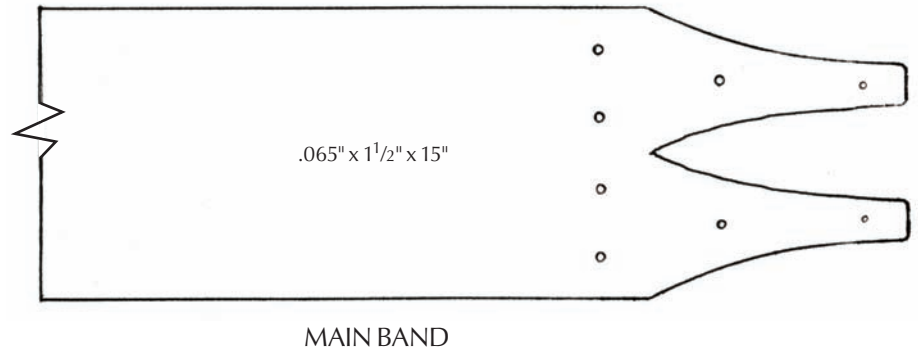

PATTERN FOR CUTTING CORE
on which to bend box band

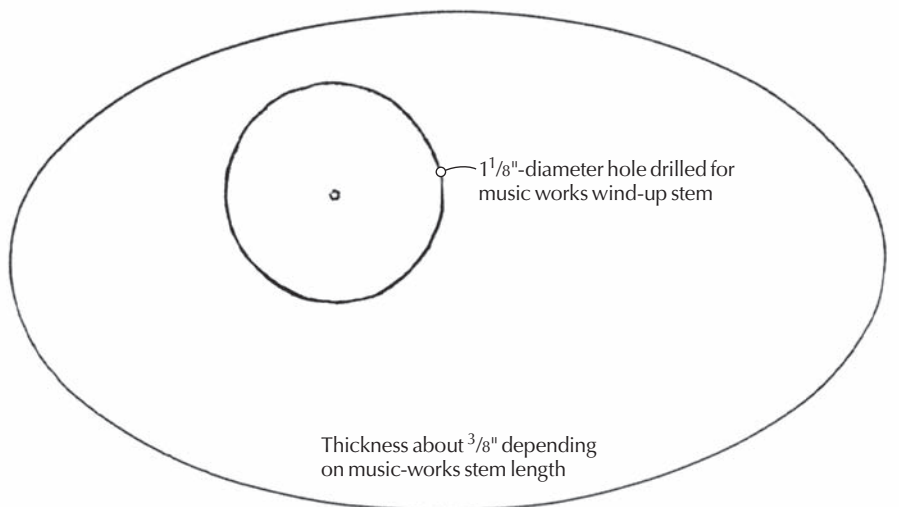

BOTTOM



1 *Cutting the box band $\frac{1}{16}$ " x $1\frac{1}{2}$ " x 15" on the table saw takes special precautions. Use a zero-clearance insert in the saw. Cut from stock that's twice the band length and keep push sticks handy. A sharp 40-tooth thin-kerf blade works best. Resawing on a band saw works well too, especially if you have a drum sander to smooth the band.*



2 *Trim the finger end after cutting the profile with a fine-toothed blade, or you can cut the entire profile with a knife. The holes for copper tacks are drilled as well. Keep the bevel edge at 10°.*

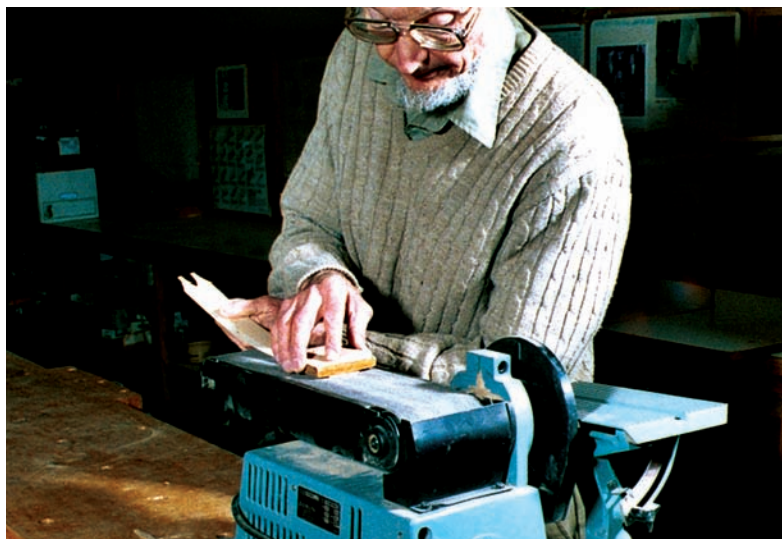

3 *The band will be ready for hot water after feathering the inside end. A wood block holds even pressure on the band to bevel the last 1" of the band.*



4 *A piece of 1" foamboard can make a handy core and shaper for the wet band. It is shown here being finished after cutting. The arrow points to the start mark for bending. If solid wood is used, separate shapers will be needed that are cork shaped to go in each side of the opening, as shrinkage in drying would lock up a wooden core with straight sides.*



5 *A band of this length can fit into a pan already on hand. However, plain aluminum pans will discolor cherry wood. The water needs to be hotter than 180° for a soaking that takes from 15-30 minutes, depending on the wood.*



6 *Bending the hot wet band into an ellipse on the foam oval core. Start at the mark, cross the front and press the band into the curve of the tight ends to give ample support to the wood fibers as they bend.*

support behind it with your hand (as shown in photo #6) rather like pressing it into the bend. When done, hold both fingers to prevent splitting up the middle. Make a pencil mark across the lapped band to record the size.

The band is allowed to open slightly so the foam core can be removed. Restore the size by observing the pencil mark. Because the foam core will be inserted to hold the band shape

while drying, you want to pass the pencil mark slightly by $\frac{1}{8}$ " to make the ellipse smaller to ensure a tight fit. The band is tacked with #1 copper tacks made especially for Shaker oval boxes. These will clinch on the inside to make a permanent joint. An 8" length of 1" steel pipe will serve as an anvil.

The oval foam core is now used as a shaper by inserting it into the tacked band. A solid-

wood oval would not work as shrinkage of the wet band would leave it permanently inside the band; only the foamboard is flexible. This is now ready for the top band to be bent and marked. Unlike the first band, you will observe this circumference mark exactly. Tack the lid band and return it to the bottom unit, matching the finger design for position and direction. This will now be left to dry for a day or two.



7 When done with the bend, mark the overlap with a pencil to record the circumference. Hold both fingers of the band securely to avoid splitting, then remove the core. Close the band to its pencil mark, and then close it $\frac{1}{8}$ " more to ensure a snug fit when the foam core is used as a shaper.



8 Small copper tacks clinch the band. They need to go in straight and hit the pipe anvil to hook well on the inside. Avoid hitting the last tack at the finger ends too hard as it might split the wood.



9 When the band is tacked, press the foam core into the wet band to hold its shape for drying.



10 The top band, which will go around the lid, is prepared, soaked and bent in the same way as the bottom band. Here the band is being bent around the completed bottom band. Pencil mark the lap.



11 The top band is removed from the bottom, and closed to its proper size as marked. Do not go past the pencil mark this time. Use the same small tacks, and return the band to the bottom section for drying. Align the fingers as shown. Allow to dry for one to two days.



12 *The dry band is sanded inside, and used as the pattern for cutting the top and bottom ovals. It is now that the finger direction is determined. Both the top and bottom go the same way. Note that the lid band will be turned over to fit on top when complete. Therefore, finger direction now will be as shown in the photo.*

Part II: Fitting the Top and Bottom

The dimensions of stock for the top and bottom are each different due to the music-works stem. It is the winding stem that defines the thickness of the bottom. Also, resonance varies with different wood. Pine, cedar or mahogany are preferred by instrument makers over cherry or hard maple, which are better bending stock. A bottom board $\frac{3}{8}$ " thick is the right size on the current stock of music works, but I've had some that were $\frac{7}{16}$ ". A $1\frac{1}{8}$ " hole is cut for the winding stem before fitting the oval board. The top for a #1 box is $\frac{7}{32}$ " thick. Both should be thoroughly dry so no shrinkage occurs after fitting into the band. Wood stored outside or in an unheated area should be allowed to dry inside for a few days after dimensioning and before fitting. Stand boards on edge so both sides dry equally.



13 *Cut the boards on a band saw keeping slightly outside the pencil line.*



14 *Sanding to fit is done here on the disc sander. The table is tilted up beyond a right angle to the disc (it's about 2°) to give the boards a slight cork effect. This will ensure a tight fit.*



15 *Press the oval board into place beginning with the front edge and ending at the back. This will avoid catching the feathered end as the oval is pressed in. Any gaps remaining in the joint are filled with a wipe of glue and sanded immediately to load the wet glue line with sanding dust.*



16 *A simple guide is used for drilling the holes for wood pegs. The wood strip is $\frac{1}{16}$ " x $\frac{1}{2}$ " x 8". The $\frac{5}{64}$ " drill bit is chucked with 1" exposed from the drill motor. Holes are centered on the top board. To the left you can see a scrap of top board used to check accuracy before drilling the holes every 2" around the perimeter.*

The bands are used to trace the oval for both bottom and top. Use a mechanical pencil for line accuracy. The direction of the fingers is determined by how you lay the band on the board. Most Shaker boxes point right, but whether right or left, both top and bottom point the same way.

Cut the oval then sand up to the line. For this project the edge is slightly beveled to aid in a tight fit. About 2° seems to work with the thick bottom board. The drawing is on the inside surface, so slightly lift the disc sander table to achieve the 2° cork effect. Lift the disc sander table until 1/8" shows at the heel of a square laid against the disc. If your disc table will not go beyond 0°, try taping a scrap of 1/16" veneer to the table to support the outside edge of the oval board when sanding.

Engage the oval board into the front face of the band, then work the back into place and push down with hand pressure. This will

avoid catching and tearing the feather end. When flush all around, sand flat.

The board is held in place with wood pegs (toothpicks cut in half work well) in holes 3/64" drilled 1/2" deep every 2" around the perimeter. Holding the drill accurately to avoid breaking through the surface of the board is a challenge. Without making a special drilling jig, you can tape a strip of 1/16"-thick x 1/2"-wide veneer to your bench. Chuck the 3/64" drill with 1" of the bit exposed. Photo 16 shows how the veneer will guide your drill bit for depth and placement during this step. I suggest you try a scrap of the top board to be sure it is working as you expect.

The wood pegs are tapped firmly into the holes before being snipped off and sanded flush. Any gaps in the joint where board meets band can be filled with carpenter's glue wiped into the crack and sanded immediately so the wet glue line is filled with sanding dust

as well as removing all traces of glue from the surface.

Part III: Music Works and Finishing

After all box parts are complete, the box is sanded. Oval boxes are traditionally left unfinished on the inside to avoid pent-up odors from oil or varnish. Any finish you use for other projects will work for your box. Cherry will achieve its own patina if left with a clear coat rather than stain.

The music works are attached with four small screws. Center the winding stem in the hole and locate the screw holes with a nail or sharp awl.

Children and adults too find the music box fascinating, especially hearing the sound amplified by putting the top on and covering the music works. The message of the Shaker song is one to match the beauty of the box – "Tis the gift to be simple." **PW**

17 Tap toothpicks into the holes. If securely in place, no glue is needed. Snip off and sand flush.



John is the founder of *The Home Shop* (ShakerOvalBox.com) in Charlotte, Michigan, which produces and sells supplies for making Shaker oval boxes. His shop was featured in *Great Woodshops*, in the August 2007 issue of *Popular Woodworking* (#163).

18 The music works is screwed into the box after all sanding is complete. Shaker boxes are normally left unfinished inside while clear coating the outside. Four small screw holes are centered and drilled if a hardwood board is used. In softwood, only an awl point is needed. The stem will center in the hole. The 3/8"-thick bottom board allows it to sit flat on the table.



Supplies

Any project is the conclusion of a variety of sources. The author acknowledges his debt to two individuals who have made this exact project first seen 20 years ago: Dick Soule, founder of Orleans Carpenters, and Dick Dabrowski, whose company, Shaker Workshops, has been at the forefront of bringing quality reproductions and adaptations of Shaker handwork to the public.

The Home Shop

517-543-5325 or ShakerOvalBox.com

A full line of Shaker oval box supplies, kits and instruction including:

- #1 copper tacks (\$5/oz)
- "Simple Gifts" music works (\$15)
- music box kit (\$35)

Lee Valley Tools LTD

800-871-8158 or LeeValley.com

- #1 copper tacks (\$5/oz)
- box making kits

Shaker Workshops

800-840-9121 or ShakerWorkshops.com

- "Simple Gifts" music works (\$15)
- finished music box (\$40)

Prices correct at time of publication.

Great Work from a Small Shop

Robert L. Millard builds fine Federal reproductions in a one-car garage with just a few small machines.

Whenever woodworkers get together shop space becomes a major topic. I've heard, "How large is your shop?" on more than one occasion. When examining woodworking successes, you might think there's a correlation between the quality of work and the size of one's shop. This article should put that notion to rest.

About 30 miles north of Cincinnati off Interstate 70, near Dayton, Ohio, we found a woodshop in which some of the finest selections of Federal furniture are being built. We didn't discover this shop by accident. Many woodworkers know of or have heard of the owner/furniture maker Robert L. Millard.

His work is shipped to discerning customers all over the United States and has been acknowledged on many woodworking forums. He's contributed to magazines as well as written for the Journal of the Society of American Period Furniture Makers.

Fascinating Federal Furniture

Although he builds pieces from most periods, Millard's passion is precise reproductions of Federal furniture. When asked why Federal period work, his reply is that he is not great at carving.

"I can carve feet and fans, but when it came to vines and other carvings that were used on higher-end furniture in the Queen Anne and Chippendale periods, I had trouble."

Then in 1998, two years after he started to build furniture for patrons, a customer requested a piece from the Federal period. Immediately, Millard knew he'd found his preferred style. (See more of Millard's work at his web site americanfederalperiod.com).

Federal decoration is mainly inlay and veneer. When studying the intricacies of inlay,



Organization is key. Projects of any scale build easy in Millard's small, well-organized workspace. His tools are a short reach away when needed and are stored neatly out of the way when not.

Millard clearly understood how the many pieces fit together to form the intricate designs. He understood the idea so well that he has never purchased a piece of inlay for any of his work. From the simple checkerboard designs to the most complicated lunette inlay, each is made in his shop, one design at a time. While we were visiting he pulled out an oversize cardboard tube full of various inlay designs with incredible detail.

Millard doesn't focus on just any Federal-period furniture. His eye is drawn to the best from the period. He studies and builds designs from the most well-known builders of the period, including John and Thomas Seymour. And did I mention that Millard has never taken a woodworking class? All his work, from veneer to inlay to finishing, is self-taught.

Large on Furniture, Small on Shop

Millard tosses a monkey wrench into the "bigger shop, better workmanship" misconception. His shop is a one-car garage that shares space with his car on a nightly basis. There's no heat or air conditioning in his shop, but he does have a small room located adjacent to the main shop area that is temperature-regulated for finishing. "I'm not bothered by the small

space, but I would like to have more storage room for materials," he says.

We had the opportunity to see a few examples of his work during our visit. Sitting on one of his benches was a shelf clock ready to ship to its new owner, sans the movement. In addition, he was finishing a card table with a shop-made oval inlay of an open-winged eagle (Millard makes it in the old-world manner) and later he brought out a sweet reproduction Federal tea caddy of which a few were gifts for special customers.

A Place for Every Tool

How does Millard produce such high-quality, detail-oriented work from his small shop?

The majority of his furniture making is handwork, but of course, power tools play an important, although somewhat lesser, role for him. Millard's most important power tool is the 14" band saw that stands prominently centered in the shop as he works his magic. On casters so it can be maneuvered at day's end, the band saw is responsible for most of the ripping and cutting action. And it becomes even more of a workhorse when slicing and fitting small pieces to create strips of inlay and shop-cut veneer.

He does own a table saw, a 10" benchtop



A view from the inside. From just inside the shop door, Millard's most important power tool, his band saw, stands ready for action while evidence of detail work rests on the cabinets.



Inlay makes it pop. This shelf clock displays a few of the intricate shop-made inlay designs Millard copied from original work.



It's a sweet gift. Millard gave a classic tea caddy to his valued customers. The eagle inlay is shop-made.

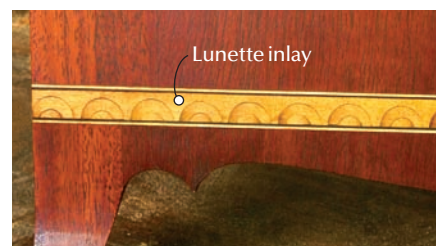

One strip at a time. Most strip inlay is sliced from blocks of assembled pieces, however this lunette inlay was made one strip at a time. The lunette inlay was popular on Seymour furniture.

model. The day we stopped by, the table saw, shown hanging in the photo at below right (look closely, it's hard to see), had a generous coating of shop dust – evidence that the tool had not been used in a while.

Other power tools in the shop include his favorite, a benchtop planer (which was serving as a television stand on the day of our visit), a benchtop drill press and a small lathe that are stored behind cupboard doors, as is a scroll saw. A small aged shaper that Millard says is rarely used (but handy to have around) sits as a “catch-all” table in one corner of the shop.

These normally stationary tools are pulled from the deep recesses of storage when called into action and plunked onto benches to do their jobs. Afterward, they return to the wings to await another work order. By putting all his tools back in their spaces when not in use, Millard makes the best use of his space.

In addition, he has all the customary hand-held power tools that you would expect in a woodshop. A jigsaw, miter saw and random-orbit sander are close at hand, but neatly stored in out-of-the-way closets. He has a couple hand-held drills and a selection of routers that, while not his favorite tools in the shop, he finds extremely useful when it comes to his style of woodworking.

It's All About Hand Tools

The crux of Millard's woodworking is hand tools. He creates his furniture with the same tools and techniques as the original period furniture makers. Accurate reproductions are what he strives to create.

His assortment of planes is impressive, if not overwhelming. He names most numbers associated with planes when asked to create a list. There are examples from Lie-Nielsen (a No. 4, a large shoulder plane and a miter plane), a Veritas scraper plane as well as a jointer plane by Clark & Williams. But the majority of his planes have the name Stanley embossed on the tools – evidence that you don't have to break the bank in order to produce great work. Millard also has a couple wooden planes that he built himself.

When persuaded to pick his favorite plane or planes he answered, “I have two favorites, the Stanley/Bailey No. 7, I purchased new in 1979, and the Lie-Nielsen No. 4.” He also favors his other Lie-Nielsen planes as well as a homemade scrub plane that sees a lot of use.

Other hand tools found stored conveniently in the shop are a couple dozen Pfeil carving tools, a small selection of Japanese chisels (preferred because of the hollow-ground backs which Millard feels makes them easy to keep

sharp and they're well balanced in his hand), a couple marking gauges and a few Starrett layout tools along with a number of hand-saws. His favorite handsaw is his 1925 Disston crosscut saw that was part of his grandfather's collection back in the day.

Millard says, “I don't have a lot of tools because it doesn't take many to make furniture.”

You might be surprised by what he says is his overall favorite woodworking tool: “My homemade, and somewhat crude veneer hammer, because it is central to the signature part of Federal furniture. Of all the aspects of furniture making, I enjoy veneering the most.” **PW**

Glen is a senior editor of Popular Woodworking, a published author, host of the Woodworker's Edge DVD series and teaches woodworking classes and seminars. Contact him at 513-531-2690 x1293 or glen.huey@fwpubs.com.

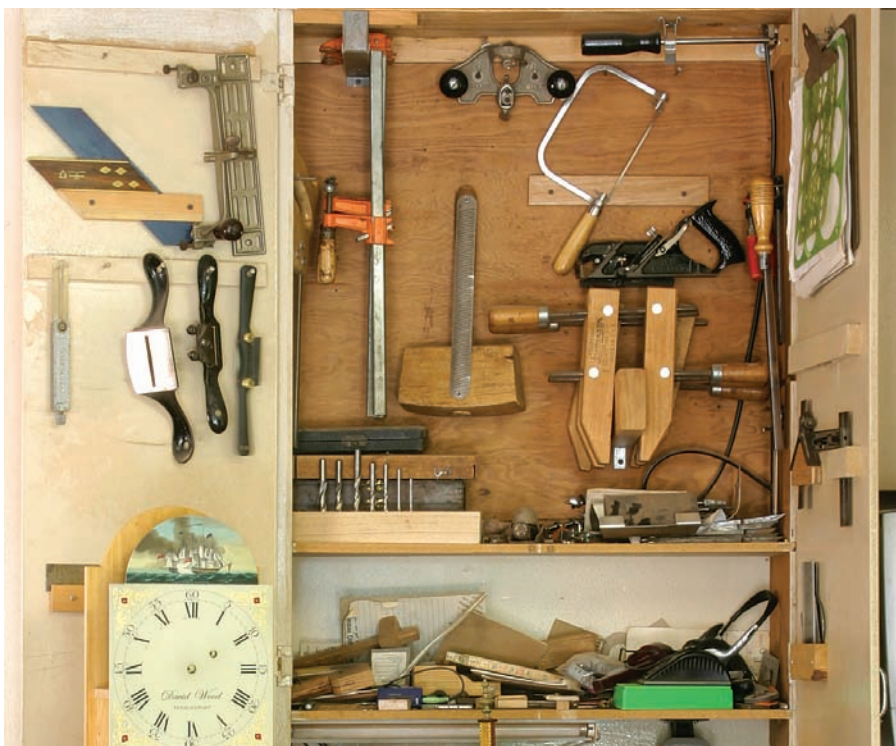

Time to organize. Millard's Newburyport, Mass., shelf clock perches under a his hand tools. Everything has its place.



Not your average stationary tools. You have to look closely to spot the table saw hanging above a small shaper that acts as a “catch all” shelf.

STEVE WALL LUMBER CO.

Quality Hardwoods and Woodworking machinery For The Craftsman and Educational Institutions

Ash	4/4	Select	\$ 2.60	\$ 94.00
Basswood	4/4	Select	1.95	80.00
Birch	4/4	Select	3.55	108.00
Butternut	4/4	1C	2.95	88.00
Cherry	4/4	Select	4.90	117.00
Hickory - Pecan	4/4	Select	3.00	100.00
Mahogany (Genuine)	4/4	Select	4.70	112.00
Maple (Hard)	4/4	Select	3.45	108.00
Maple (Soft)	4/4	Select	2.50	88.00
Poplar	4/4	Select	1.80	78.00
Red Oak	4/4	Select	2.70	96.00
Walnut	4/4	Select	4.90	115.00
White Oak	4/4	Select	2.70	96.00
Cedar (Aromatic Red)	4/4	1C+Btr.	1.80	78.00
Cypress	4/4	Select	2.60	90.00
White Pine	4/4	F.G.	1.25	70.00
Yellow Pine	4/4	Clear	\$ 2.30	\$ 82.00

Above prices are for 100' quantities of kilndried rough lumber sold by the Bd. Ft. FOB Mayodan, NC. Call for quantity discounts. Other sizes and grades available.

Above prices are 20 bd. ft. bundles of clear kilndried lumber 3'-10" wide x 3'-9" long (Random widths & lengths) Surfaced 2 sides or rough. Delivered UPS prepaid in the Continental U.S.

**UPS
Specials**

**SEE OUR
CATALOG ON
THE WEB!**

OLIVER MACHINERY DEALER
HARDWOOD PLYWOOD
CUSTOM RAISED PANEL DOORS
CUSTOM PLANK HRDWD FLOORING
THIN CRAFTWOOD
EXOTIC LUMBER

**STEVE H. WALL
LUMBER CO.**
BOX 287
MAYODAN, N.C. 27027
336-427-0637
1-800-633-4062
FAX 336-427-7588
Email: wood@walllumber.com
Website: www.walllumber.com

Send \$1.00 For Lumber Catalog
Prices Subject to Change Without Notice

CIRCLE #159 ON FREE INFORMATION CARD.

POPULAR WOODWORKING
Best NEW TOOL 2004

INFINITY BEST VALUE FOR
Fine WoodWorking MAGAZINE

Introducing our
AWARD-WINNING
**8" Stacked Dado Set...
The Dadonator™** Exclusive 6-Tooth Chipper Design!

Item #SDB-800
Only \$189.90

Visit infinitytools.com for what's new & innovative in wood cutting tools!

- Router Bits
- Shaper Cutters
- Planer/Jointer Knives
- Saw Blades

INFINITY
CUTTING TOOLS

TOLL FREE 877-872-2487

CIRCLE #126 ON FREE INFORMATION CARD.

The
ARROW
X Machine
ETFX50™



XTRA HEAVY DUTY
Professional

XCEPTIONAL COMFORT
Cushioned Grip

XPERT PERFORMANCE
Drives 6 Different Size Staples+Nails

XTRAORDINARY POWER
14 Amps of Surge Power

XCITING DESIGN
New Ergonomic Styling

14 AMP SURGE POWER

UL LISTED 284C LR32816

MADE IN USA
HECHO EN E.U.A.

Keeping America Strong

... It's what you've come to EXPECT from Arrow!

Available at home centers, lumberyards, and fine hardware stores wherever professional tools are sold!

Arrow Fastener Co., Inc., 271 Mayhill Street, Saddle Brook, New Jersey 07663
Canada: Jardel Distributors, Inc., 6505 Metropolitan Blvd. East, Montreal, Quebec H1P 1X9
Arrow Fastener (U.K) Ltd., Unit 5 ZK Park, 23 Commerce Way, Croydon CR0 4ZS, Surrey, United Kingdom
www.arrowfastener.com
©2007 Arrow Fastener Co., Inc.

CIRCLE #102 ON FREE INFORMATION CARD.

Woodturning Tools & Accessories **Free 42pg Catalog!**

- Lathes & Accessories
- Four Jaw Chucks
- Grinding Jigs
- Turning Tools & Handles
- Vacuum Chucking
- Faceplates
- Bowl Coring Systems
- Spur Centers
- Metal Spinning
- Revolving Centers

ONEWAY MANUFACTURING
1-800-565-7288
www.oneway.ca

CIRCLE #140 ON FREE INFORMATION CARD.

WHITECHAPEL LTD
Over 4000 fine hardware essentials



English Gothic Revival Ring Handle

315 PAGE COLOR CATALOG \$5.00
1-307-739-9478 whitechapel-ltd.com

CIRCLE #160 ON FREE INFORMATION CARD.

BOBSRULE.COM



24 BOBS = 1 INCH

"THE RULES HAVE CHANGED!"
www.bobsrule.com

CIRCLE #107 ON FREE INFORMATION CARD.

Join

WOODWORKER'S BOOK CLUB

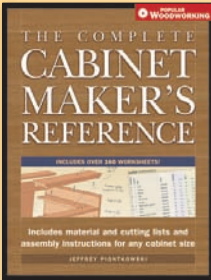

#70710-9 ~~\$29.99~~ hc
(Lay-Flat Spiral Binding)

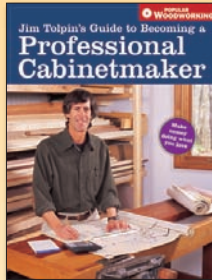

#70705-9 ~~\$24.99~~ pb



#70723-2 ~~\$24.99~~ pb

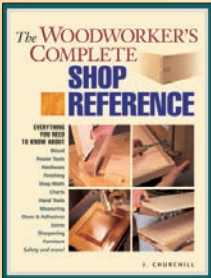

#70579-8 ~~\$26.99~~ pb

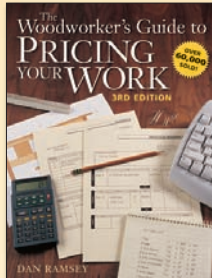

#70690-3 ~~\$22.99~~ pb



#70547-5 ~~\$24.99~~ pb

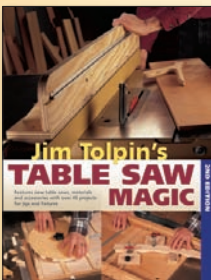

#70627-5 ~~\$24.99~~ pb

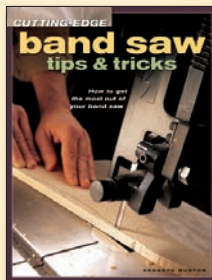

#70653-1 ~~\$24.99~~ pb



#70661-4 ~~\$24.99~~ pb

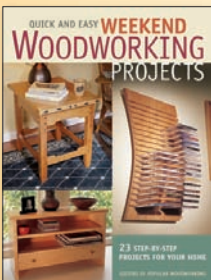

#70698-6 ~~\$24.99~~ pb



#70704-2 ~~\$24.99~~ pb



#Z0027-0 ~~\$24.99~~ pb

CHOOSE **3** BOOKS

FREE

with a 4th book for just **\$9.99**
(plus shipping/handling)

BONUS

Join today to receive
a **FREE Gift!**



Uncover the secrets to getting the perfect finish — every time! Finishing guru Bob Flexner shows you how.

A \$3.95 value, yours **FREE** with membership!

There is **NO OBLIGATION**
to buy any more books!

HURRY!
MAIL YOUR
MEMBERSHIP
SAVINGS CERTIFICATE
TODAY!

Join online @

www.WoodWorkersBookClub.com

for an even larger book selection!



NEW

#Z0815-0 ~~\$24.99~~ pb



#Z0348-0 ~~\$24.99~~ pb



NEW

#Z0978-0 ~~\$24.99~~ pb



NEW
2 Book Set

Counts As One Selection
#Z0437-0 ~~\$29.98~~ hc



#Z0030-0 ~~\$26.99~~ pb

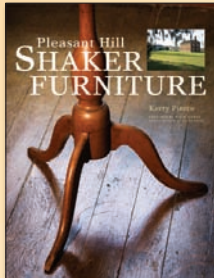

#Z0564-0 ~~\$30.00~~ hc



#Z0489-0 ~~\$24.99~~ pb



#Z0725-7 ~~\$24.99~~ hc
(Lay-Flat Spiral Binding)



#Z0722-4 ~~\$29.99~~ hc
(Lay-Flat Spiral Binding)



#Z0708-3 ~~\$24.99~~ pb



#Z0713-3 ~~\$24.99~~ pb



#Z0693-7 ~~\$24.99~~ pb

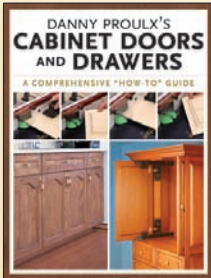

#Z0692-9 ~~\$24.99~~ pb



#Z0668-9 ~~\$22.99~~ pb

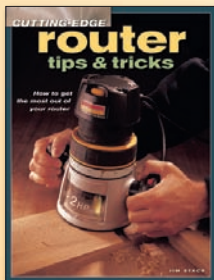

#Z0649-9 ~~\$24.99~~ pb



#Z0697-8 ~~\$24.99~~ pb

Prices are publishers' list prices.

MEMBERSHIP SAVINGS CERTIFICATE

YES! I want to join WoodWorker's Book Club. Please send me:

I'm adding \$7.99 shipping & handling for a total payment of \$17.98.

VISA/MasterCard/AmEx Orders Call
TOLL FREE 1-800-448-0912
9a.m.-7p.m. M-F 9a.m.-6p.m. Sat EST

Check/money order enclosed (or)
 Charge my VISA MC AmEx

ACCT # _____

My 1ST BOOK **FREE**
[] [] [] [] - [] []
My 2ND BOOK **FREE**
[] [] [] [] - [] []
My 3RD BOOK **FREE**
[] [] [] [] - [] []
My 4TH Book For **\$9.99**
[] [] [] [] - [] []
Plus My **FREE** Gift
80390-8

EXP. DATE
[] [] [] [] - [] [] [] []

I have read How the Club Works above and understand that I am under **NO OBLIGATION** to buy any more books.

Signature _____

Name _____

Address _____

City _____ State/Prov. _____

ZIP/PC _____ Phone (____) _____ - _____

E-mail _____

Offer good for new members in U.S. and Canada only. In CA, CO, GA, MA, MI, NY and OH please add applicable state tax. In Canada provide a street address and remit in U.S. funds; enclose \$10.39 s&h and \$1.22 GST for a total of \$21.60. One membership per household. Allow 3-4 weeks for delivery. The Club reserves the right to approve all applications and may cancel membership at any time.

YOU SAVE MONEY & GET THESE SPECIAL MEMBERSHIP PRIVILEGES!

- **NO-OBLIGATION OFFER** means you'll never have to buy another book unless YOU want to!
- **EARN FREE BOOKS** Every book you buy at regular Club prices counts toward a FREE Book!
- **HARD-TO-BEAT SAVINGS** of 15-50% off every book you buy!
- **FREE INFORMATION-PACKED CLUB BULLETIN** filled with top-notch books — chosen by woodworkers for woodworkers!
- **EASY-TO-USE MEMBERS-ONLY WEB SITE** View our comprehensive catalog of books and U-BILD plans (450+!). Plus you can accept or decline your main selection and browse actual pages of books!
- **FREE SHIPPING AND HANDLING** when you prepay your orders after this joining offer!
- **MONEY-BACK GUARANTEE** If you're not 100% satisfied with any book you buy, return it within 15 days for a prompt refund...no questions asked!

MAIL TO

WOODWORKER'S
BOOK CLUB

P.O. Box 9274 Central Islip, NY 11722-9274

www.WoodWorkersBookClub.com

A division of F+W Publications, Inc.

ORDER CODE: KAL07PW

Bench Hook

The single most important hand-tool appliance is 3 sticks of wood.

Owning a backsaw without owning a bench hook is like riding a bicycle without handlebars. This simple hand-tool appliance (three sticks of wood) uses the force of the tool and gravity to hold your work as you saw. And it helps guide your tool so your cuts are right on the line.

It also allows you to make cuts with ease that are terrifying (or should be terrifying) on a power saw. A bench hook also can serve as a shooting board for trimming the face grain and end grain of small pieces of work with the help of a handplane. Plus, building one takes minutes, not hours.

Now I wish I could tell you that I've cooked up a new design of bench hook that trumps traditional designs. I haven't. In fact, I think that's an unlikely thing to accomplish.

The only "improvement" that we moderns can offer is to make it with power equipment, which improves the long-term reliability of the bench hook. Here's what I mean:

All bench hooks have three parts: The bed, which is the flat part where you put the work; the fence, which is what you push the work against; and the hook, which lips over the front edge of your benchtop.

Early bench hooks were made from one piece of wood. The bed, fence and hook were all sawn from a single piece of thick stock. Later bench hooks were made from three pieces of wood, but the grain of the fence and the hook were at 90° to that of the bed, so your bench hook could self-destruct (thank you seasonal expansion and contraction) before the appliance got completely chewed up by your saw.



Get hooked. Bench hooks make your handsawing safer and more accurate. After working with one for a couple weeks, you will wonder how you ever got by without it.

With the help of accurate, modern table saws, it's easy to make bench hooks so that the grain direction in all three pieces is aligned. And that's exactly what you should do. (Or even make it out of plywood.)

Part Sizes and Assembly

Bench hooks can be almost any size. The sizes shown in this article make a bench hook that's

convenient for most sawing. Glue and nail the three parts together, using a square to ensure the fence is square to the bed.

With your bench hook assembled, mark a scale on its fence in 1/2" or 1/4" increments. The scale helps you cut short bits to length. When the glue dries, you're ready to go to work. Don't apply a film finish to the bench hook; that will only make it slippery and difficult

Online EXTRAS

For a video on using a bench hook, go to: popularwoodworking.com/nov07

CONTINUED ON PAGE 88

FEEL THE DIFFERENCE.

COMPACT.
LITHIUM-ION
18V POWER.



**18V Compact
Lithium-Ion
2-Piece Combo Kit**
MODEL LCT200W



visit makitatools.com or call 1-800-4MAKITA



BEST POWER-TO-WEIGHT RATIO

Makita's best-in-class engineering delivers innovation again. Feel Makita's new 18V Compact Lithium-Ion Cordless Series as it has the best power-to-weight ratio available in a compact design. The 1/2" Driver-Drill weighs only 3.5 lbs. which is 2 lbs. less than the competition plus it produces 450 in.lbs. of torque. The Impact Driver weighs only 2.8 lbs. while delivering an impressive 1,280 in.lbs. of torque. Each tool comes with a built-in LED light and the kit includes a Rapid 15-minute battery charger.

MORE POWER. LESS WEIGHT. BETTER ENGINEERING.

Makita
INDUSTRIAL POWER TOOLS

CIRCLE #132 ON FREE INFORMATION CARD.

for you to keep your work in place. Then make a second bench hook without the fence. This second appliance supports long workpieces hanging off your first bench hook.

Using the Hook

The first rule of bench hooks: They are disposable. You will cut them up until they're unusable. So don't fret when you slice up the bed. In general, you place your work against the fence and hold it there with your off-hand while you saw with your dominant hand. As with all sawing, it's best to advance on two lines instead of one – so try to saw through an edge and a face at the same time. This trick will make all your saw cuts more accurate.

In general, I line up the edge of the bench hook's fence with the line I've marked on the wood. Lining up your fence and your cut line creates one longer line, and that's a visual cue that will help you saw straighter.

As with all sawing, allow your sawing arm the freedom to move back and forth without rubbing against your torso. That helps improve your accuracy, too.

Using a bench hook allows you to do things safely, accurately and more quickly than with any other setup. I like to use them to cut small parts to precise lengths. I simply clamp a spring clamp to the fence at the desired dimension and butt my stock against the clamp. There's no better way to cut short dowels for pegging joints.

Bench Hooks and Planes

I use my bench hook with a plane just as often as I use it with a saw. When working the shoulders and cheeks of tenons with a

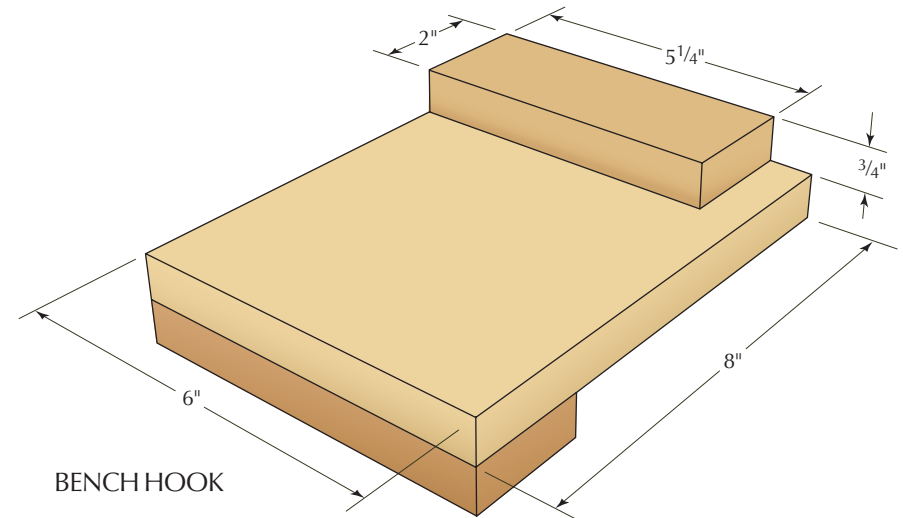

shoulder plane, I push the work against the fence with my off-hand and plane with my dominant one.

I also use the bench hook like a small shooting board. Flip the bench hook upside down so the fence hooks over the benchtop and you are working into the hook. The extra-wide hook prevents (or reduces) blow-out on the outfeed side of your cut. Your handplane (choose a tool with lots of mass) rides on your benchtop. Butt your stock against the sole of the plane then push the plane forward to shave off a little bit of the work. This is a great way to fit mullions in a divided-light door.

You also can use the bench hook to plane the long grain of short pieces. Push the part's end grain against the fence of the bench hook and plane away. This is easier than trying to secure little bits in your vise.

Once you have made a couple bench hooks, you'll start using them to hold your work instead of reaching for a clamp. I secure

Bench Hook

NO.	ITEM	DIMENSIONS (INCHES)			MATERIAL
		T	W	L	
❑	1 Bed	3/4	6	8	Hardwood
❑	1 Fence	3/4	5 1/4	2	Hardwood
❑	1 Hook	3/4	6	2	Hardwood

stuff against them for chiseling and rasping all the time.

Most important, I think you'll like your backsaw a lot more and use it for more operations. I've been in too many shops where backsaws were assumed to be freehand tools, so the resident woodworker was either a highly skilled sawyer or a highly frustrated one. **PW**

Chris is the editor of Popular Woodworking and author of "Workbenches: From Design & Theory to Construction & Use" (Popular Woodworking Books). You can contact him at 513-531-2690 x1407 or chris.schwarz@fwpubs.com.



Advance on two fronts. When you mark your cut line on the face of your work, wrap it around the board's edge as well. Then saw by advancing on two lines whenever you can. This greatly improves accuracy.



Shoot ends. Flip your bench hook over to use it as a small shooting board. A heavy plane with a sharp iron makes this easy. A block plane with a dull iron makes it almost impossible.



Shoot edges. The fence of your bench hook is a great planing stop when sizing small pieces. The only limitation is the thickness of the fence. It needs to be thinner than your stock. If you are going to shoot like this a lot, I'd make your fence 5/8" thick instead of 3/4".

Dust Collection. It's All We Do. Ask Us...

"The Oneida has not only eliminated the dust layer that previously coated every horizontal surface in my shop but has also made chip collection and disposal a snap, saving not only my lungs but hours and hours of cleanup time. I like working in a tidy, clean environment and the Oneida makes this possible. Many thanks for providing a clearly superior product backed by actual performance, not hype." - C.C.

"With all I have spent in new machinery (many, many dollars) the Gorilla unit truly is the cherry on the top! Thanks for a truly SOLID piece of machinery. The honesty of your "reps" and the "specs" are refreshing!" - L.H.

"It's been two years now and I couldn't be happier with my Oneida Cyclonic Dust Collector. My system continues to perform well and my lungs continue to thank you. One of my best investments I have ever made. Thanks again guys." - J.S.



Shown with optional stand.



"I found your staff excellent to deal with and the packaging of your unit is probably the best I have ever seen. The instructions with the unit are very well written and illustrated. It went together perfectly. As for performance, the Gorilla has far exceeded my expectations. Aside from amazing suction, even at the end of a 35 ft. run, the air/dust separation is really something. I blew my filter out for the first time last evening and was shocked when I removed the filter bin. There may have been 1/2 of a teaspoon of powder-like dust at best. In short, I can't say enough about your collector. Your product is number one! Hats off to you and your staff." - A.L.

- ▶ One on One Customer Service
- ▶ 1.5 - 40hp Systems
- ▶ Ductwork Design Service Available
- ▶ Since 1993
- ▶ Ready - to - Ship Ductwork



Check Website for Specials!
www.oneida-air.com

Call Today for **FREE** Catalog!
1.800.732.4065

WOODWORKING EDUCATION FROM THE PROS

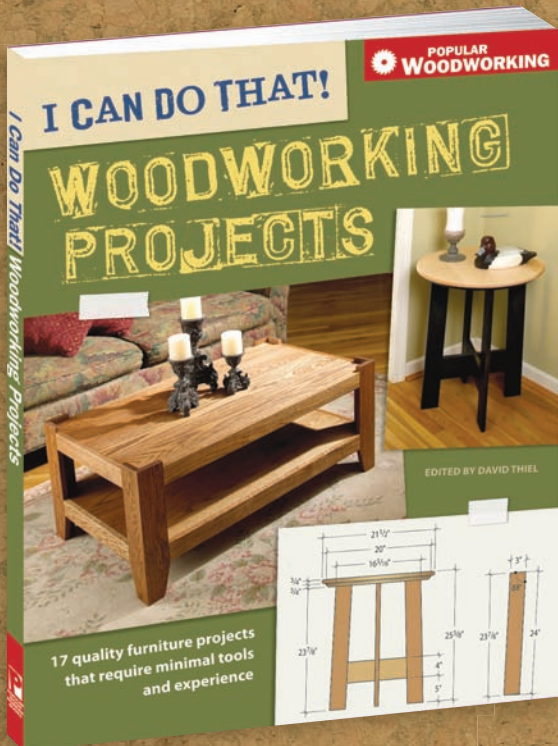

Woodworking can be an intimidating hobby for beginners, but not with *I Can Do That! Woodworking Projects*. This easy-to-do primer showcases quality furniture pieces that can be built using a modest tool kit and materials that are available at any home center—and in less than 2 days of shop time. In addition to the attractive projects, a comprehensive tool manual explains the purpose of each tool along with basic woodworking operations in a step-by-step format. This is the ideal book for beginning DIY woodworking enthusiasts.

\$19.99 • ISBN-13 978-1-55870-816-7
ISBN-10 1-55870-816-2 • #Z0991-K



The router table opens up a whole new way of using the router that simply can't be done by using it freehand. What better way to learn about it than through a pro? Bill Hylton, Mr. Router himself, will teach you everything there is to know about router tables. Learn how to build your own table or what to look for when buying a pre-manufactured one. In addition to basic router-table knowledge, illustrations and close-ups will explain *why* operations should be in a specific way. Enhance your woodworking projects by expanding your knowledge of the router table.

\$24.99 • ISBN-13 978-1-55870-796-2
ISBN-10 1-55870-796-4 • #Z0595-K

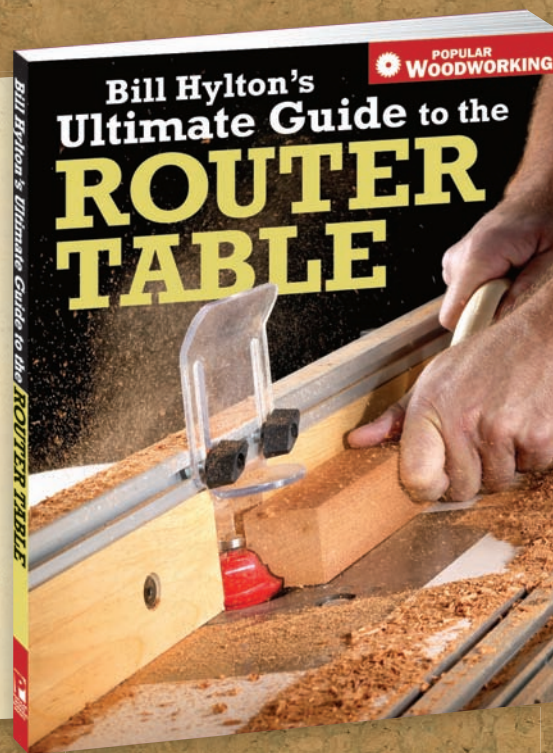

an imprint of
F+W Publications, Inc.

You can find these books and many more Popular Woodworking books at your favorite bookseller (including BarnesandNoble.com, Amazon.com and BookSense.com). Or order by calling 1-800-448-0915, or visit us online at www.fwbookstore.com.

The Web's Best Woodworking Resource Just Got Better!

You already know **PopularWoodworking.com** is your first source for online project plans, reference tools, expert tips — and exclusive content you won't find anywhere else. And now, there are even more features to enjoy than ever before!

You'll find fresh project plans, articles and techniques every day of the week — and these **FREE** resources are already available for use:

Streaming Video Player

The *PW* staff shows you special techniques

Finishing Section

Bob Flexner's tried-and-true advice makes staining a snap

Complete Article Index

Easy reference to every *PW* article published since 1993

PW Staff Blogs

Weekly woodworking perspectives and expert guidance

Online Bookstore

Where to buy the books and back issues you want

The screenshot shows a web browser window with the address bar displaying "http://www.popularwoodworking.com/". The website header features the "POPULAR Woodworking" logo with the tagline "Learn How • Discover Why • Build Better". A navigation menu includes "ARTICLES", "TOOLS & TECHNIQUES", "PROJECT PLANS", "ARTICLE INDEX", and "BLOGS". The main content area highlights a "FEATURE ARTICLE:" titled "The Sindelar Tool Collection" with a photo of a man holding tools. Below this are sections for "HOT TOPICS", "PROJECT PLANS", and "TOP BLOGS". A red banner at the bottom right of the screenshot contains the "POPULAR Woodworking" logo and tagline, with a mouse cursor pointing to it.

Get a daily dose of FREE woodworking insight at popularwoodworking.com!

PRODUCT INDEX

	PAGE #	CIRCLE #	WEB ADDRESS
ABRASIVES			
Norton Abrasives	19	136	nortonabrasives.com
ADHESIVES			
Franklin International	25	118	titebond.com
Gorilla Glue	35	121	gorillaglu.com
BITS, BLADES & CUTTERS			
Amana Tool	35	100	amanatool.com
Forrest Mfg.	29	117	forrestblades.com
Freud USA	11	119	freudtools.com
Infinity Tools	83	126	infinitytools.com
Ridge Carbide Tools	95	149	ridgecarbide.com
Routerbits.com	94	153	routerbits.com
Woodline	19	163	woodline.com
BOOKS & VIDEOS			
Popular Woodworking Books	90	—	popularwoodworking.com
Rob Cosman	93	145	robcosman.com
Wonderful Wood	94	161	wonderfulwood.com
Woodworker's Book Club	84-85	—	woodworkersbookclub.com
FASTENERS			
Arrow Fasteners	83	102	arrowfasteners.com
McFeely's	24	135	mcfelys.com
FINISHES & SUPPLIES			
Apollo Sprayers Int'l.	18	101	hvp.com
FURNITURE & PROJECT PARTS			
Osborne Wood Products	25	141	osbornewood.com
HAND TOOLS			
Blue Spruce Toolworks	94	106	bluesprucetoolworks.com
Bob's Rule	83	107	bobsrule.com
Bridge City Toolworks	35	109	bridgecitytools.com
Craftsman Studio	94	110	craftsmanstudio.com
Crown Plane Co.	94	111	crownplane.com
Fine Tool Journal	94	116	finetoolj.com
Japan Woodworker	31	127	thejapanwoodworker.com
Lee Valley	23	130	leevalley.com
Lie-Nielsen Toolworks	31	131	lie-nielsen.com
Manny's	94	133	mannyswoodworkersplace.com
Powell Manufacturing	95	146	planeperfect.com
Robert Larson	94	151	rlarson.com
Tools for Working Wood	31	157	toolsforworkingwood.com
HARDWARE			
Ball & Ball	35	104	ballandball-us.com
Whitechapel Ltd.	83	160	whitechapel-ltd.com
Woodworker's Hardware	24	166	wwhardware.com
KITS & PLANS			
Craftsman Plans	95	—	craftsmanplans.com
Pygmy Boats	95	148	pygmyboats.com
Texas Knifemaker	95	156	texasknife.com
U-Bild.com	94	158	u-bild.com
POWER TOOL ACCESSORIES			
Beall Tool Company	94	105	bealltool.com
Drill Doctor	15	112	drilldoctor.com
FeatherBow	94	113	featherbow.com
HTC Products	33	125	htcproductsinc.com
JessEm Tools	31	128	jessem.com
Keller & Company	94	129	kellerdovetail.com
Leigh Industries	23	—	leighjigs.com
Woodpeckers	15	164	woodpeck.com
Work Sharp Tools	52	168	worksharptools.com
POWER TOOLS			
Bob Marino's Festool Store	18	—	bobmarinosbesttools.com
Bostitch	7	108	bostitch.com
Fein Power Tools	2	114	feinus.com
Festool	C3	115	festool-usa.com
General Mfg.	23	120	general.ca
Grizzly Industrial	C2-1	123	grizzly.com
Makita USA	87	132	makitatools.com
Oneway	83	140	oneway.on.ca

POWER TOOLS, cont'd

	PAGE #	CIRCLE #	WEB ADDRESS
Powermatic	9	147	powermatic.com
Rikon Power Tools	33	150	rikontools.com
Ryobi	C4	154	ryobitools.com
Steel City Toolworks	21	155	steelcitytoolworks.com
Woodstock International	13	165	woodstockinternational.com

SAWMILLS & KILNS

Granberg International	94	122	granberg.com
Norwood Industries	94	137	norwoodindustries.com

SCHOOL/INSTRUCTION

Center for Furniture Craftsmanship	31	—	woodschoool.org
Marc Adams School	15	134	marcadams.com
Old English Academy of Woodworking	95	138	oefcc.com
Philadelphia Furniture Workshop	95	144	philadelphiafurnitureworkshop.com

SHOP ACCESSORIES

Oneida Air Systems	89	139	oneida-air.com
--------------------	----	-----	----------------

TURNING SUPPLIES

Augums Pen Works	94	103	augumspenworks.com
Packard Woodworks	95	142	packardwoodworks.com

WOOD & VENEERS

Wall Lumber	83	159	walllumber.com
Woodfinder	95	—	woodfinder.com
Woodworker's Source	95	167	woodworkerssource.com

WOODWORKING CATALOGS

Hartville Tool	35	124	hartvilletool.com
Penn State Industries	25	143	pennstateind.com
Rockler	15	152	rockler.com
Woodcraft	17, 33	162, 174	woodcraft.com

The newest issue of Woodworking Magazine has arrived!



The Autumn 2007 issue of *Woodworking Magazine* is here, and it's bigger and better than ever.

You can download the issue via enhanced PDF for just \$6 or get a printed copy mailed directly to you for \$8. Or, with our special combo deal, get both for just \$10!

For more information or to order your copy of *Woodworking Magazine* Autumn 2007, log on to woodworking-magazine.com/backissues

WOODWORKING

MAGAZINE

NOW AVAILABLE!
Rob Cosman's DVD

The amazing
WOOD-HINGE



Learn Rob's secrets and you'll be making this amazing wood hinge in no time!
 1 hr 40 min

To preview and order, visit
www.robcosman.com

dvd also available at www.lie-nielsen.com *and* www.woodcraft.com

CIRCLE #145 ON FREE INFORMATION CARD.

Digital downloads of
Woodworking Magazine
 now available on our site!



You can now download single issues of *Woodworking Magazine* for just \$6 each. Each issue is fully searchable and can be easily viewed and printed using Adobe Acrobat's free reader (If you don't have it already, you can download it at adobe.com.)

To purchase your downloadable issues, visit
woodworking-magazine.com/backissues

WOODWORKING
 MAGAZINE

ADVERTISER INDEX

ADVERTISER	PAGE #	CIRCLE #	WEB ADDRESS
Amana Tool	35	100	amanatool.com
Apollo Sprayers Int'l.	18	101	hvlp.com
Arrow Fasteners	83	102	arrowfasteners.com
Augums Pen Works	94	103	augumspenworks.com
Ball & Ball	35	104	ballandball-us.com
Beall Tool Company	94	105	bealltool.com
Blue Spruce Toolworks	94	106	bluesprucetoolworks.com
Bob Marino's Festool Store	18	—	bobmarinosbesttools.com
Bob's Rule	83	107	bobsrule.com
Bostitch	7	108	bostitch.com
Bridge City Toolworks	35	109	bridgecitytools.com
Center for Furniture Craftmanship	31	—	woodschoool.org
Craftsman Plans	95	—	craftsmanplans.com
Craftsman Studio	94	110	craftsmanstudio.com
Crown Plane Co.	94	111	crownplane.com
Drill Doctor	15	112	drilldoctor.com
FeatherBow	94	113	featherbow.com
Fein Power Tools	2	114	feinus.com
Festool	C3	115	festool-usa.com
Fine Tool Journal	94	116	finetoolj.com
Forrest Mfg.	29	117	forrestblades.com
Franklin International	25	118	titebond.com
Freud USA	11	119	freudtools.com
General Mfg.	23	120	general.ca
Gorilla Glue	35	121	gorillaglu.com
Granberg International	94	122	granberg.com
Grizzly Industrial	C2-1	123	grizzly.com
Hartville Tool	35	124	hartvilletool.com
HTC Products	33	125	htcproductsinc.com
Infinity Tools	83	126	infinitytools.com
Japan Woodworker	31	127	thejapanwoodworker.com
JessEm Tools	31	128	jessem.com
Keller & Company	94	129	kellerdovetail.com
Lee Valley	23	130	leevalley.com
Leigh Industries	23	—	leighjigs.com
Lie-Nielsen Toolworks	31	131	lie-nielsen.com
Makita USA	87	132	makitatools.com
Manny's	94	133	mannyswoodworkersplace.com
Marc Adams School	15	134	marcadams.com
McFeely's	24	135	mcfelys.com
Norton Abrasives	19	136	nortonabrasives.com
Norwood Industries	94	137	norwoodindustries.com
Old English Academy of Woodworking	95	138	oefcc.com
Oneida Air Systems	89	139	oneida-air.com
Oneway	83	140	oneway.on.ca
Osborne Wood Products	25	141	osbornewood.com
Packard Woodworks	95	142	packardwoodworks.com
Penn State Industries	25	143	pennstateind.com
Philadelphia Furniture Workshop	95	144	philadelphiafurnitureworkshop.com
Popular Woodworking Books	90	—	popularwoodworking.com
Powell Manufacturing	95	146	planeperfect.com
Powermatic	9	147	powermatic.com
Pygmy Boats	95	148	pygmyboats.com
Ridge Carbide Tools	95	149	ridgecarbide.com
Rikon Power Tools	33	150	rikontools.com
Rob Cosman	93	145	robcosman.com
Robert Larson	94	151	rlarson.com
Rockler	15	152	rockler.com
Routerbits.com	94	153	routerbits.com
Ryobi	C4	154	ryobitools.com
Steel City Toolworks	21	155	steelcitytoolworks.com
Texas Knifemaker	95	156	texasknife.com
Tools for Working Wood	31	157	toolsforworkingwood.com
U-Bild.com	94	158	u-bild.com
Wall Lumber	83	159	walllumber.com
Whitechapel Ltd.	83	160	whitechapel-ltd.com
Wonderful Wood	94	161	wonderfulwood.com
Woodcraft	17, 33	162, 174	woodcraft.com
Woodfinder	95	—	woodfinder.com
Woodline	19	163	woodline.com
Woodpeckers	15	164	woodpeck.com
Woodstock International	13	165	woodstockinternational.com
Woodworker's Book Club	84-85	—	woodworkersbookclub.com
Woodworker's Hardware	24	166	wwhardware.com
Woodworker's Source	95	167	woodworkerssource.com
Work Sharp Tools	52	168	worksharptools.com

NORWOOD INDUSTRIES INC.
1-800-661-7746-Ext. 441
norwoodindustries.com



PERSONAL SAWMILLS

From \$2,990

CIRCLE #137 ON FREE INFORMATION CARD.

FEATHERBOW

FeatherBow 3 in1 \$29.95

- Traditional featherboard
- Single feather
- Bow with 10LB and 35LB Gauge

Fits in standard 3/4" miter slot. Comes with 5 push sticks

FeatherBow Jr. 2 in1 \$17.95

- Single feather for light work
- Bow that holds your work down

Made in USA Pat. Pending

860-209-5786 featherbow.com
137 TROUTSTREAM DRIVE, VERNON, CT. 06066

CIRCLE #113 ON FREE INFORMATION CARD.

Gladstone TOOLS™

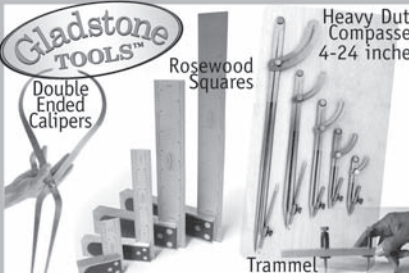

Heavy Duty Compasses 4-24 inches

Rosewood Squares

Double Ended Calipers

Trammel Points

Order online: www.gladstonetools.com or www.mannyswoodworkersplace.com or by phone 1-800-243-0713
425 Curry Avenue, Lexington, Ky 40508

CIRCLE #133 ON FREE INFORMATION CARD.

SIMPLE DOVETAILED

No trial and error adjustments.
Order your Keller Dovetail System now!
(800) 995-2456

Made in the USA since 1976 • DVD/Video \$8.95 + \$2 p/h

www.simpledovetails.com

CIRCLE #129 ON FREE INFORMATION CARD.

U-BILD.COM

Hundreds of full-size woodworking plans at low prices. Free downloadable mini-plans. Indoor, outdoor, children's and holiday projects at all skill levels. 48-page catalog \$2.00 (refunded on 1st order) call (800) 828-2453.

CIRCLE #158 ON FREE INFORMATION CARD.

Routerbits.com
Bits, Blades, Books, & More...

Whiteside Router Bits
Systematic Saw Blades Bench Dog
Fisch Forstner Bits
www.Routerbits.com

Call For Your Free Catalog
1-888-811-7269

CIRCLE #153 ON FREE INFORMATION CARD.

CraftsmanStudio.com
Fine Tools - Fair Prices - Fast Shipping

Shapton GlassStones®
Premium Quality
Cut Faster - Wear Longer
Try them today!
Introductory Free Shipping

Expires 11/30/07 - Online Orders only
4848 Ronson Ct • Suite L • San Diego, CA 888-500-9093

CIRCLE #110 ON FREE INFORMATION CARD.

CROWN PLANE COMPANY
TRADITIONAL BENCH MADE PLANES
JACK..SMOOTH..SCRUB..SCRAPERS..BLOCK
CHAIRMAKERS TRAVISHERS..COMPASS PLANES
18 Chase Street South Portland, ME 04106
(207) 799-7535
Order Online www.crownplane.com

CIRCLE #111 ON FREE INFORMATION CARD.

Lie-Nielsen Standard or Low
Angle Block Plane.
Special \$135.00.

Fine Tool Journal
27 Fickett Rd.,
Pownal, ME 04069
(800) 248-8114

Always Free
US Shipping on
Lie-Nielsen Tools!

Full line
on web.
www.FineToolJ.com/LN



CIRCLE #116 ON FREE INFORMATION CARD.

STOP BUYING LUMBER!

Mill your own...
with Granberg's Alaskan Saw Mill!

Made in the U.S.A.

The Mark III

Prices start at **\$135!**
(G777 Small Log Mill)

Use our attachment and your chain saw to make beautiful lumber out of any log!
Call toll free for our FREE DVD and catalog!
866-233-6499 www.granberg.com



CIRCLE #122 ON FREE INFORMATION CARD.

NEW! Two Cherries Butt Chisels



Same high quality blades, new shorter size with wooden handle.
Made in Germany.

Robert Larson Company
www.rlarson.com • 1-800-356-2195

CIRCLE #151 ON FREE INFORMATION CARD.

TILT BOX
Pat. Pend.

Accurately reads relative angles

Magnets on the sides cling to metal surfaces.

Also gauges actual level

THE BEALL TOOL CO.
1-800-331-4718 Fax 1-740-345-5880
www.bealltool.com Dpt. FW

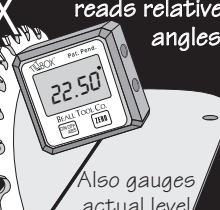

CIRCLE #105 ON FREE INFORMATION CARD.

Wanna Turn Bowls?

Critically Acclaimed Videos featuring Bill Grumbine
Turned Bowls Made Easy & Beyond the Basic Bowl

To order or learn more, call 610-248-7661 or visit me at www.wonderfulwood.com



CIRCLE #161 ON FREE INFORMATION CARD.

Blue Spruce Toolworks

Beautiful hand tools for precision joinery

www.BLUESPRUCETOOLWORKS.com



CIRCLE #106 ON FREE INFORMATION CARD.

Augum's Pen Works

The Largest Selection of Turning Kits and Woodworking Supplies Online!
Penn State Industries, Berea Hardwoods & More!
Pen, Keychain, Bottle Stopper Kits + Many More!
Everything You Need:
Tools, Adhesives, Finishing Supplies, Gift & Display Boxes,
Inlay Supplies (Inlase, Crushed Stone), Jewelry Supplies, Wood Blanks, Horn, Colorply, Diamondwood, Aquapearl + More!
All At The LOWEST PRICES On The Internet!
Number ONE In Customer Relations!
Come Give Us A Look!

www.AUGUMSPENWORKS.com

CIRCLE #103 ON FREE INFORMATION CARD.

WOODWORKER'S MARKETPLACE



**Old English Academy
of Fine Woodworking**
Michael J. Gray Master
Learn from an Old World Master
the Fundamentals of Fine Woodworking
Hands on Instruction for Groups & Individuals
Weekend Classes Year Round
P.O. Box 772 Selmer, TN 38375
www.oefcc.com

CIRCLE #138 ON FREE INFORMATION CARD.

Texas Knifemaker's Supply
Make knives for fun and profit. We
have all the supplies & kits for
custom knifemaking.
*Easy transition from woodworking to knife
making because you already have the tools
*Pre-made finished blanks ready to assemble Free catalog
Call 888-461-8632 www.texasknife.com

CIRCLE #156 ON FREE INFORMATION CARD.

HARDWOODS
Lumber • Veneer • Turning Stock
exoticwoods.net
800.423.2450
Wood Descriptions • Secure Online Ordering
**WOODWORKERS
Source**
18115 N. Black Canyon Hwy. • Phoenix, AZ 85023
645 W. Elliott Rd. • Tempe, AZ 85284
3441 S. Palo Verde • Tucson, AZ 85713

CIRCLE #167 ON FREE INFORMATION CARD.



Philadelphia Furniture Workshop
Hands-On Instruction; All Levels
Mario Rodriguez, Artist in Residence
www.philadelphiafurnitureworkshop.com
215-849-5174

CIRCLE #144 ON FREE INFORMATION CARD.

RIDGE CARBIDE TOOL CO.
WWW.RIDGECARBIDETOOL.COM
America's Best Custom
Saw Blades Bits
Router Bits Cutters
Sharpening Profile Knives
TOLL FREE: (800) 443-0992 TOLL FREE FAX: (888) 728-8665

CIRCLE #149 ON FREE INFORMATION CARD.

CRAFTSMAN PLANS
Authentic
Reproduction
PLANS
BOOKS
HARDWARE
Measured & Drawn by Robert W. Lang
author of
"Shop Drawings for Craftsman Furniture"
www.craftsmanplans.com

Top-Rated Sea Kayaks
Rugged, Ultra-Light Beautiful Leader in Kayak Kits Since 1986
PYGMY BOATS, INC.
CALL OR WRITE FOR OUR FREE COLOR CATALOG
(360)385-6143, P.O. Box 1529, Dept 30
Port Townsend, WA 98368
www.pygmyboats.com

CIRCLE #148 ON FREE INFORMATION CARD.

**ODATE CROWNING
& DRESSING PLATES**
Powell Mfg. Co. (781) 237-4876
396 Washington St. #114, Wellesley, MA 02481 USA
www.planeperfect.com

CIRCLE #146 ON FREE INFORMATION CARD.

Get a Free Copy of our
CATALOG for
WOODTURNERS
Call Toll Free... 1-800-683-8876
or write...
Packard Woodworks PO Box 718 Tryon, NC 28782
website: www.packardwoodworks.com

CIRCLE #142 ON FREE INFORMATION CARD.

Looking for wood?
VISIT **woodfinder**
It's fast, easy and FREE!
www.woodfinder.com
No computer? Call toll-free 1-877-933-4637

FREE PROJECT PLANS
www.popularwoodworking.com
FREE PROJECT PLANS
www.popularwoodworking.com
FREE PROJECT PLANS
www.popularwoodworking.com
FREE PROJECT PLANS

CLASSIFIED

Classified rate is \$5.00 per word, 15-word minimum. Order must be accompanied by payment; ads are non-commissionable. Send to: *Popular Woodworking*, 4700 E. Galbraith Rd., Cincinnati, OH 45236 or Don Schroder, d.schroder@verizon.net. Phone: 610-821-4425, Fax: 610-821-7884.

Bits, Blades & Cutters

PLANER KNIVES ANYONE CAN CHANGE at a price anyone can afford. Instant, accurate knife changes. Every machine, every time. German quality. Time-proven performance. Superior customer service. www.dispozablade.com. 800-557-8092.

Books

WE HAVE A WIDE VARIETY of woodworking books—from small projects, to home improvement, to enhancing your woodworking skills, and more! To see our full line of books, please visit our web site at www.popularwoodworking.com/store/books!

Business Opportunities

\$400 WEEKLY ASSEMBLING PRODUCTS from home. Rush SASE: Home Assembly - PW, Box 216, New Britain, CT 06050-0216.

Finishing Supplies & Equipment

SPRAY-ON SUEDE—Line boxes easily. Free brochure with sample. DonJer, 13142 Murphy Road, Winnebago, IL 61088; 800-336-6537; www.donjer.com.

Hand Tools

DI LEGNO WOODSHOP SUPPLY. Quality woodworking hand tools at an affordable price. www.dlws.com or 1-877-208-4298.

Power Tools

FEIN TOOLS - YOU'RE JUST ONE CLICK AWAY from the Fein Tools that you can't do without - MultiMaster Tools - Sanders - Routers - Grinder - Vacuums and more, plus all Accessories and Parts. <http://www.waltertool.com> or 800-356-6926.

WWW.TOOLSANDMORE.US Full line of Shop Fox® Machinery. 1000's of Woodworking Tools. Low Prices, Fast Shipping. 352/754-9335.

Schools/Instruction

WOODWORKING COURSE Novice through intermediate, self-paced. Interactive CD-ROM based. Windows compatible. Only \$29.00. Order at www.fineboxes.com or 613-821-5160.

JOHN C. CAMPBELL FOLK SCHOOL, Brasstown, NC. Courses for all skill levels. Weeklong and weekend classes year-round, taught by nationally known instructors. Friendly, supportive environment. Comfortable, on-campus housing. Delicious meals served three times a day. www.folkschool.org. 800/365-5724.

Wood & Veneers

WWW.WALNUTWOODS.NET Black Walnut Burl Veneer, lumber, turning stock, gunstocks. Buckeye Burl slabs. Call 559-277-8456, Newton Woods, Fresno, CA

CURLY CHERRY \$6.00BF - domestic, figured, and quartersawn lumber. Lowest prices. (937) 572-9663. www.crlumber.com Xenia, Ohio.

Home-center Finishing

You can achieve a great finish from commonly available products.

We all love home centers for the good stuff they carry and for their low prices. But home centers cater to the lowest common denominator consumer – that is, they carry only the stuff that has a big market.

The result is that many of the finishing products used on furniture and cabinets, products you read about in woodworking magazines or hear about in woodworking classes, are rarely found in these stores. Examples include very fine-grit sandpapers, dyes, glazes, paste wood fillers, spray lacquers and high-performance finishes such as catalyzed lacquer.

So how do you proceed if you have to do your finishing entirely from the products available at home centers?

It's not all that difficult, really. You're just limited in some of the decorative effects you can achieve – decorative effects you're probably not interested in anyway because you're using the natural color and figure of the wood for your decoration.

With the limited choice of finishing products at home centers, you can still get all the following:

- Protection and durability ranging from minimal to the best possible
- A sheen ranging from gloss to dead flat
- Finishes ranging from amber to colorless
- A near-flawless finish resembling sprayed lacquer
- Elimination of blotching from stains
- A glaze substitute
- A pore-filling option
- The ability to block off problems in the wood.

Marketing

Before proceeding with how to accomplish these objectives, I want to explain how com-



Home-store finishing. You don't have to go to specialty retailers to find finishing supplies; you can produce a quality finish from products readily available at home centers.

panies producing and marketing finishing materials sell their products (how all companies probably sell their products, for that matter).

Finish companies target specific markets. Within any given category – oil stain, varnish, water-based finish, etc. – all companies' products are very similar, if not identical. But because stores and catalogs carry different brands, and because the marketing can sometimes make you believe some brands are somehow better than others, you may think you're getting inferior products at low-end, mass-consumer home centers when you're not.

For example, a big brand name in home

centers is Minwax, while General Finishes and Behlen dominate in woodworking stores and catalogs, and Old Masters is popular in independent paint stores. There are also stores that feature Sherwin-Williams, Benjamin Moore, Pratt & Lambert, Varathane and many other brands.

In addition, some companies target just contractors, others target cabinet and furniture makers, and still others (an entirely different group of companies) target refinishers.

Within any finish category – oil stain, glaze, varnish, lacquer, etc. – all these companies make essentially the same thing. They all have access to the same raw materials, and the instructions for putting these raw materi-

als together are available to everyone, even to you and me if we want them.

So there's nothing at all inferior about the finishing products available at home centers. There's only a limitation of what's available.

From these limited choices, however, you have many possibilities for achieving the results you want.

Protection and Durability

You have control of the amount of protection and durability you get simply by how much you build your finish and by your choice of finish. (See "Test to Find a Durable Finish" at popularwoodworking.com/finishing.)

Protection means resistance to moisture penetration into the wood—in liquid or vapor (humidity) form. All finishes provide better resistance the thicker they are, so the finishes that harden well and can be built up on the wood are capable of much better protection than finishes such as boiled linseed oil, 100-percent tung oil and blends of one of these oils and varnish, that don't harden.

Among the finishes that harden, oil-based polyurethane varnish provides the best resistance to moisture penetration and also the best durability—that is, the best resistance to being damaged by scratches, heat, solvents, acids and alkalis. Polyurethane is almost as protective and durable as the best of the high-performance finishes used in industry.

Following polyurethane in declining order are alkyd (regular) varnish, polyurethane water-based finish, acrylic water-based finish, lacquer and shellac.

But even fresh shellac is considerably more protective and durable than the finishes that

don't harden, as long as you apply several coats. Because shellac loses a lot of hardness and water resistance as it ages in the can, it's best to use it within a year of manufacture. The date of manufacture is stamped on the bottom of the can.

Color

The color you get on the wood is partially contributed by the finish. Finishes differ in how much yellowing or "orangeing" they add.

Amber shellac adds the most orange color. You can use this finish on pine, for example, to create the knotty-pine look popular in the 1950s, or recreate the warmth common on oak trim and paneling original to early 20th-century houses.

Boiled linseed oil and 100-percent tung oil have a slight yellow color to begin with, and then they yellow, or rather orange, significantly as they age. You can use either of these finishes under any other finish to achieve this orangeing as long as you let the oil cure well first. A week or two in a warm room should be adequate.

Oil-based varnishes, lacquer and clear shellac also have a slight yellow tint, which may darken a little with age. But the finish most significant for color is water-based, both polyurethane and acrylic. These finishes aren't, and don't, yellow at all. They are "water clear."

So you would choose a water-based finish for light woods such as maple or ash, or for white pickled woods, if you don't want them to have a yellow tint. You would probably choose one of the other finishes for darker woods because water-based finishes usually make

these woods appear "washed out" unless you apply a stain underneath.

Sheen

It's rare that home centers provide finishes with sheens other than gloss and satin (shellac comes in gloss only), but you can use these two to achieve any sheen you want.

Sheen is the amount of gloss, or reflection, in a finish. If no flattening agent is added—that is, there's nothing at the bottom of the can that has to be stirred into suspension before application—the finish produces a gloss, or sharp image clarity. Manufacturers create satin and flat finishes by adding a flattening agent, which is usually silica. The more flattening agent added the less reflective the finish.



Create custom colors. Keeping in mind that the name of the color on the stain can be merely a manufacturer's interpretation, you can adjust any stain by mixing. You can even mix two or more stains of different brands as long as you stay within one type: oil or water-based. Here, I'm increasing the reddish tint in a "walnut" stain by adding some "mahogany."

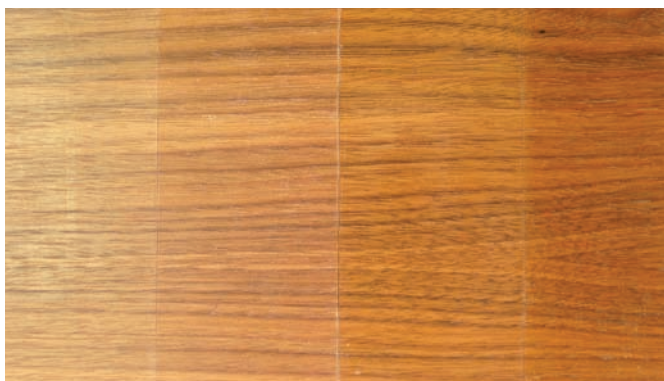

Orange effects. Your choice of finish can have a big effect on the color you get, whether or not you have stained the wood. From the left, water-based finish darkens this walnut a little but doesn't add any color; lacquer adds a little yellowing; polyurethane varnish adds a little orange; and amber shellac adds a distinctly orange coloring.

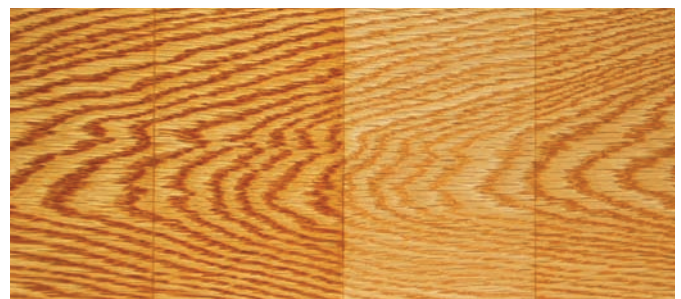

The aging process. Boiled linseed oil and 100 percent tung oil add yellow coloring to the wood initially but then darken significantly as they age. This oak board was finished with three coats of each finish more than five years ago. From the left are boiled linseed oil, 100 percent tung oil, wiping varnish (varnish thinned half with mineral spirits), and a half-and-half mixture of boiled linseed oil and varnish. Notice that the linseed and tung oils have orangeed about the same and that the mixture of oil and varnish has darkened about halfway between that of the oils and varnish alone.



Control sheen. You can achieve any sheen you want just from the gloss and satin varieties of varnish, water-based finish and lacquer offered in home centers. To get a sheen in between the gloss and satin, mix the two. To get a sheen flatter than the satin, pour off some of the finish (as I'm doing here) from a can of satin in which you have allowed the flattening agent to settle, and then mix the two to get what you want.

To get a sheen in between that of gloss and satin within any finish type—varnish, lacquer or water-base—simply mix the two (after stirring the satin, of course). To get a sheen flatter than the satin, let the flattening agent settle (don't let the store clerk shake the can) and pour off some of the top. What is left will be much flatter. You can then mix these to get something in between if you want.

Because it is the top, or last, coat applied that is responsible for determining all of the sheen, you can change the appearance simply by applying another coat with a different sheen. (See "Some Reflections on Sheen" at popularwoodworking.com/finishing.)

Avoiding Flaws

Spray guns can be used to produce nearly flawless, meaning almost perfectly level, sur-



No HVLP necessary. You can use aerosols as an alternative to a spray gun to achieve a level surface. Aerosols are available in polyurethane and water-based finish in addition to lacquer. To get a thicker build with less expense, brush two or three coats, then sand the surface level up to #400 grit and spray a couple of coats with the aerosol.

faces. But you can achieve the same without a spray gun simply by thinning the finish or using an aerosol. The thinner (meaning "thinned") the finish, the better it levels and the faster it dries.

Better leveling means no brush marks. Faster drying means reduced dust nibs.

You can thin any finish to get it to level better, but the easiest to use are the varnishes. All home centers carry already thinned alkyd and polyurethane varnishes. These are sometimes labeled "Wipe-On Poly," but also "tung oil," "tung oil finish" or "tung oil varnish." In no cases do these products (which I call "wiping varnish" because they're easy to wipe on wood) have anything to do with tung oil, but they produce wonderful results nevertheless.

There are three good ways to apply a wiping varnish: Wipe or brush it on the wood

and wipe off all the excess; wipe or brush it on and wipe off some or most of the excess; brush it on and leave it. The more you leave the greater the build but the longer time dust has to settle and stick to the finish.

To get a thick build with fewer coats, brush several full-strength coats of alkyd or polyurethane varnish, sand the surface level up to #400-grit sandpaper, then apply several coats of wiping varnish and wipe off some or most of the excess. You can make the wiping varnish yourself by thinning the same finish you're brushing by half with mineral spirits, or you can use one of the already thinned brands. (See "The Basics of Wiping Varnish" in the November 2005 issue, #151.)

You can also use an aerosol for your finishing. Aerosols are now available in oil-based polyurethane and water-based finish in addition to lacquer and shellac, but they are relatively expensive. Instead of building all your coats with the aerosol, you can brush a couple, sand out the brush marks then use the aerosol of the same type of finish to apply level final coats. (See "Aerosol Spray Finishing" at popularwoodworking.com/finishing.)

Whatever finish you're applying and however you're applying it, always watch it in a reflected light to spot runs as they develop and respread or rewipe to remove some of the excess.

Whatever method you use to get a level surface, rub it lightly with a folded brown paper bag after the finish has hardened to remove minor dust nibs and make the surface feel smoother.

Blotching

Blotching is uneven, and usually ugly, coloration caused by stains penetrating the wood unevenly.

To avoid blotching on softwoods such as pine, use a gel stain. This is a stain thickened enough so it doesn't penetrate. Gel stains ought to be called "pine stain" because they are so effective at eliminating blotching in pine.

On hardwoods such as cherry, birch, maple and poplar, it's more effective to use a washcoat. This is any finish thinned to about a 10 percent solids content. Lacquer is used in industry, but the type sold in home centers is varnish or a blend of oil and varnish labeled "wood conditioner" or "stain controller." You can make your own by thinning any full-strength varnish or blend of boiled linseed oil and varnish with two parts mineral spirits.

Thin to achieve a smooth finish. To eliminate brush marks (shown on the left), thin the finish a quarter to a half with the appropriate thinner and then brush it. If you want to speed the build, brush two or three full-strength coats, then sand the surface level up to #400 grit and apply a couple thinned coats.

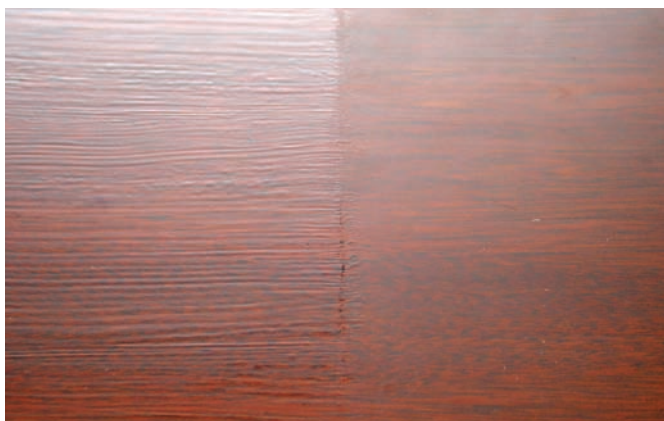

When you apply this washcoat, be sure to let it cure at least six hours in a warm room, better overnight, or it won't be very effective. This is different than the directions on the cans, which usually say to apply the stain within two hours.

There is no need to apply a washcoat to woods such as oak, ash, walnut and mahogany that don't blotch. (See "Battling Blotching" at popularwoodworking.com/finishing.)

Glaze Substitute

Colored glazes are used to add highlighting, antiquing or create faux graining over at least one coat of finish. Glazes are rarely available in home centers, but you can substitute a gel stain with excellent results. Glazes and gel stains are essentially the same thing anyway – a thickened stain.

To do glazing, brush or wipe the glaze or gel stain over at least one coat of finish and then remove all the color you don't want using a rag, brush, sponge, graining tool (usually available at home centers), steel wool or any other tool that produces the results you want.

A typical use of glaze on cabinets and furniture is to leave it in recesses to add three-dimensional depth or an antique look. Be sure to apply at least one coat of finish over the glaze after it has dried to protect it from being scratched or rubbed off. (See "Glazes and Glazing Techniques" at popularwoodworking.com/finishing.)

Pore Filling

Some woods look better with their pores filled to create a "mirror-flat" surface. Mahogany is the best example.

Products called "paste wood filler" or "grain filler" (not the same as wood putty or wood filler) designed to achieve this look are rarely available at home centers. But you can achieve the same result by sanding a number of coats of finish down to the deepest level of the pores. You can sand a little between each coat, or you can sand more after you have applied all the coats.

Because we all apply finishes differently, you will have to experiment on scrap to determine the number of coats necessary so you don't sand through.

For the easiest sanding between coats, use steared sandpaper. Norton "3X" and 3M "Tri-Mite" and "Sandblaster" are all steared. This means they contain a soap-like lubricant that reduces clogging. You can use your hand to back the sandpaper when sanding between coats, but you should use a flat sanding block on flat surfaces when sanding many coats level.

For the easiest sanding after a number of coats, use black, wet-dry sandpaper with a mineral-oil, mineral-spirits or mixed mineral-oil/mineral-spirits lubricant. Begin sanding with a grit sandpaper that levels efficiently without creating larger-than-necessary scratches (for example, #320 or #400 grit) and then sand to finer grits if they are available.

If finer grits aren't available, apply one more coat of thinned finish (so it will level well), spray with an aerosol or rub the surface with #0000 steel wool. You can use a wax, oil or soap-and-water lubricant with the steel wool to reduce scratching and improve smoothness. (See "Rub to Create a Great Finish" at popularwoodworking.com/finishing.)

Problems in the Wood

Of all the finishes, shellac is easily the most effective for blocking off problems in the wood. The most common problem in new wood is resinous knots in pine and other softwoods. The resin can bleed into the finish and cause it to remain tacky and not cure.

In old (refinished) wood, the most common problems are fish eye (cratering or ridging) and odors from smoke or animal urine. Shellac blocks all these problems so you can then successfully apply any finish over it. If you are using varnish or water-based finish, it's best if you use dewaxed shellac, sold in most home centers as "SealCoat."

To make your own dewaxed shellac, pour off or decant the shellac from a can of Bull's Eye Clear Shellac after the wax has settled to the bottom. It will take a long time for this to occur on its own, so don't shake the can when you buy it, or thin the shellac with at least two parts denatured alcohol in a glass jar (so you can see it) to get it to settle faster.

If there are no problems you need to block off, there's no reason to use shellac as a first coat. (See "The Case for Shellac" at popularwoodworking.com/finishing.)

Conclusion

Somehow, a lot of unnecessary mystique is introduced into wood finishing. In reality, however, it is quite simple. This is most evident when you realize all the possibilities available from just the few products stocked by home centers. **PW**

Bob is author of "Understanding Wood Finishing" and a contributing editor to Popular Woodworking.

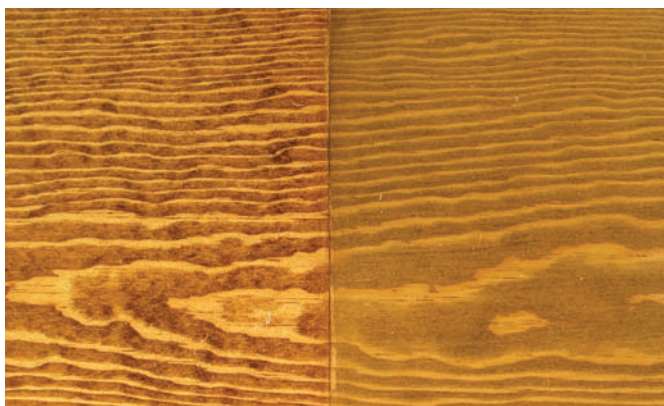

Eliminate blotching. The easy way to eliminate blotching in pine is to apply a gel stain as I have done to the right half of this pine board. The left side is stained with a liquid stain. Gel stains are so effective on pine they should be called "pine stain."

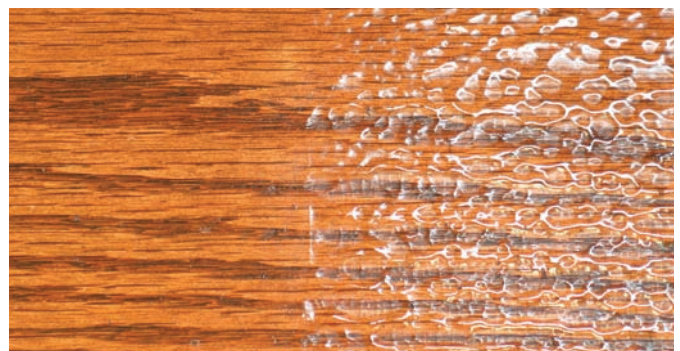

Refinishing woes. Fish eye (cratering) is one of the most serious problems in refinishing. It's caused by silicone from furniture polishes getting into the wood and causing the new finish to wrinkle when applied. One easy way to avoid fish eye is to block it with a first coat of shellac, applied here to the left side of the board. The only new-wood use for shellac as a first coat is over resinous knots in softwoods such as pine.

BY CHRIS HEDGES

Project no. 3 – er, no. 4

Your early projects don't have to end up as firewood.

When people see the Philadelphia-style secretary I built, they inevitably want to know how long I have been making furniture and how many pieces I have completed. The simple answer – 2½ years and three pieces. The truth – 3½ years and four pieces. If you're wondering why I always leave out that first piece and that extra year, let's just say that not everything always turns out as we want it to. Four years ago, I was settling into a career as a sociology professor. My wife and I were thinking about having a child, buying a house and staking our claim in life. On a whim, perhaps in pursuit of a bit of immortality, I decided to build an "heirloom" changing table/dresser. And here we arrive at the crux of the problem.

My "heirloom" has a face only a parent could love. It's bad. Real bad. Panels out-of-square and cracked, glue splotches all over the thing. Maybe you can begin to understand why I give the "simple" answer. But, that piece represented a life-changing experience for me. I realized that I passionately enjoyed making furniture. I didn't feel that way about sociology – not even close! So, with a supportive wife, a newborn child and a mortgage payment in hand (literally!), I went to the University of Rio Grande and enrolled in the Fine Woodworking program there.

The program began like most – start easy and work your way up the ladder. For me, it meant forgetting everything I thought I knew about both furniture making and myself – learn the machines, the tools, myself and the wood. I started with a Shaker nightstand and it didn't turn out too badly. It's not exactly fine furniture, but the process reminded me of a lesson I had all-but-forgotten: Don't rush to finish something just because it has to be done. It's tough to do that in a world that tells us "faster is better" or that "time is money." But when we rush it is inevitable that we forget



Technically, a beginner. This Philadelphia-style secretary was Chris Hedges' fourth woodworking project.

important steps – or even where we are going. Furniture making may appear to be a compact endeavor; in reality it is a practice of patience and perseverance.

For my second school project, I built a large flattop highboy. Although I made errors along the way, I sold it and learned another valuable lesson: One's sense of completion is often defined by one's sense of honor. When we settle for drawers that almost fit or a finish

that's almost rubbed out, then we do a disservice to others and ourselves.

As my first academic year ended, it was time to decide what I would build as an exit piece. After a few months of research and design, I settled on my own version of an oft-reproduced masterpiece – a Philadelphia style secretary. Overall, it took nine months from conception to completion to build. I'm not going to lie and say it was easy, but had I settled for anything less than a true challenge, I knew I would be disappointed. The beauty of learning is that it's not always a straightforward linear process, but one that entails a good amount of revision and head scratching.

In early May of 2007, with encouragement from my family and friends, I entered "The Goose" (as I call the piece) into the AWFS/Fresh Wood Student Design Competition. Over the course of the next two months, as judges deliberated and people voted, I was so nervous that I rarely slept more than four hours a night. Finally, after what seemed an interminable amount of time, the verdict was in. I not only won first place in the reproduction category, I won both the Best of Show and People's Choice awards. Winning these awards has been a self-affirming experience and I learned, more clearly than anything else, that it is possible to find not only some small success, but also happiness if one works hard and is willing to listen to the lessons they learn.

In case you are wondering – the secretary is still for sale. But my first piece, the "heirloom" my beautiful daughter owns? Not for a million dollars! **PW**

After deciding to give up his career as a sociology professor, Chris earned his fine woodworking credentials at the University of Rio Grande. He now plans to build furniture full time. To see his first three projects, including the heirloom dresser/changing table, visit popularwoodworking.com/nov07.

It hates
splinters
 as much as
 you do.

Festool TS Saws, the latest generation of plunge-cut saws, have reshaped the concept of precision cutting.

Featuring a splinterguard that ensures splinter-free cuts on both sides of the blade.



FastFix saw blade changing system



Precise angle cuts with no offset



Perfectly straight cuts with included guide rail



Spring-loaded riving knife



Dust extraction with 360° swivelling connector

TS Plunge-cut Saws

TS 55 EQ Plunge-cut Saw
 1 15/16" Cutting Depth

TS 75 EQ Plunge-cut Saw
 2 3/4" Cutting Depth

Festool's TS Saws and guide rail system provide straight, splinter-free cuts on both sides of the blade right out of the box. Unlike conventional pendulum-guard circular saws, Festool's design allows the saw blade to retract into the housing, giving you the option to start and end the cut accurately anywhere on the material. All of this innovation means a quicker, safer and more cost-effective precision tool. Special package pricing is available. Contact us or visit your local dealer to learn more about the TS saws, special Fall promotions, and the entire Festool system.



Add the new CT MIDI for near-total dust extraction and optimal jobsite performance.

Faster. Better. Easier.

2007 PROMOTIONS
 Fall Edition | Limited Time Offers | New Products | Power Guide

Special offers available for a limited time!

FIND YOUR DEALER | www.festoolusa.com/dealers | 888-337-8600

FESTOOL®

CIRCLE #115 ON FREE INFORMATION CARD.

WE'VE TURBOCHARGED OUR 18 VOLT TOOLS. (including those you already own)



over
35 great
One+
items

2X PERFORMANCE

2X RUN TIME **HOLDS CHARGE 4X LONGER** **20% LIGHTER WEIGHT**

Ryobi's new One+™ Lithium battery produces maximum performance for a much lower price than the competition. It powers every Ryobi 18V tool, making Ryobi One+ the most affordable and versatile 18V lithium tool system in the world.



WORKS WITH **ALL ONE+ TOOLS**
AND BATTERIES

Lithium
18V
ryobitools.com



Available at The Home Depot®

CIRCLE #154 ON FREE INFORMATION CARD.