

8

PROJECTS
INSIDE!

TESTED: 2 NEW PORTABLE PLANERS

FOUR PLANES EVERYONE SHOULD OWN

December 2000 #119

Popular Woodworking

The Skill-Building Project Magazine for Practical Woodworkers

12 Best New Tools of 2000

Revolutionary Dovetail Jig

Cut perfect joints
by hand—today!

Nick Engler's
secret to

Super-Tight Mitters

Plus

- Shaker tailor's counter
- Wright-style hall tree
- Modern storage tower

Scott Phillips

"American Woodshop" host
shares his best tricks

www.popwood.com

\$4.99US \$6.99CAN





40



46



66

IN THIS ISSUE

33 **Best New Tools of 2000**

We've been testing tools all year to bring you our list of the 12 most outstanding woodworking tools introduced in 2000.

40 **Shaker Tailor's Cabinet**

Though this drop-leaf case piece was used by tailors in the Shaker community at Watervliet, N.Y., we think you can find a use for this handsome dresser in just about any room.

By Glen Huey

46 **Dovetail Jig**

It used to be that hand-cut dovetails took years to master. Thanks to this amazing new jig, that's not true anymore. You can cut airtight dovetails today.

50 **Modern Storage Tower**

It takes up less than 2 square feet of floor space, yet it holds enough stuff for almost any home office.

56 **Introduction to Hand Planes**

Even the woodworker who has a power tool for everything needs a few decent planes in the shop. Find out which planes are essential to woodworking and what each is good for.

By Dale Lucas



33



60 Welcome Friends Plate

This little scrollsawn gem looks good hanging on your kitchen wall or displayed on a shelf.

By Rick Longabaugh

62 Compound Miters for Dummies

Cutting accurate miters and compound miters is one of the most vexing problems woodworkers face. Learn to set up your table saw to cut virtually any slope.

By Nick Engler

66 Two Tub Tables

Once you've gotten a lesson in cutting compound miters, put that knowledge to good use by constructing a walnut or plywood table.

72 Quadralinear Posts

With just one router bit, you can make lightweight, super-sturdy posts that show off oak's quarter-sawn ray flake on all four sides. Then build a Frank Lloyd Wright-inspired hall tree using those posts.

IN EVERY ISSUE

6 Out On a Limb

Welcome, Scott Phillips

8 Letters

Mail from readers

12 Tool Test

Get the inside story on new portable planers from Makita and Grizzly. Black and Decker's new plunge router is an amazing value

18 Tricks of the Trade

Scott Phillips shows you tricks that will help you sharpen tools, install hinges and tune your band saw

24 Flexner on Finishing

The basics of coloring wood

30 Projects From the Past

Modern Doll House

78 Endurance Test

Vaughan pull saws, Veritas wheel marking gauge, Timber Wolf band saw blades

82 Classifieds

84 Caption the Cartoon

Win a Freud router bit set

88 Out of the Woodwork

They're Tools, Not Toys

ON THE COVER

Scott Phillips, the amiable host of the "American Woodshop," joins us this month as a contributing editor and author of our Tricks of the Trade column.



Cover photo by Al Parrish

terrco

Circle #113 on Resource Directory Coupon

liebel & co.

Circle #132 on Resource Directory Coupon

Popular Woodworking®

December 2000, Vol. 20, No. 7

www.popwood.com

Editor & Publisher **Steve Shanesy**

Art Director **Tricia Barlow**

Senior Editors **David Thiel,**
Christopher Schwarz

Associate Editor **Jim Stuard**

Editorial Intern **John Tate**

Contributing Editors

Nick Engler

Bob Flexner

Glen Huey

Troy Sexton

Technical Advisers:

Bill Austin Makita USA, Inc.

Scott Box Delta International

Chris Carlson S-B Power Tool

Dale Zimmerman Franklin International

General Manager **Jeffrey M. Lapin**

Editorial Director **David Fryxell**

Senior Art Director **Amy Schneider**

CIRCULATION

David Lee, Director

Lynn Kruetzkamp, Single Copy Sales Mgr.

Terry Webster-Isgro, Direct Sales Mgr.

PRODUCTION

Barbara Schmitz,

Director of Manufacturing

Martha Wallace, Magazine Production Dir.

Heather Griffin, Production Coordinator

Ruth Preston, Studio Manager

ADVERTISING

National Sales Representative

Bill Warren, Five Mile River Assoc. LLC

RR1 Box 1400, Stockton Springs, ME 04981

Tel. (207) 469-1981; Fax (207) 469-3050

Advertising Sales

Joe Wood, Tel. (513) 336-9760

Fax (513) 336-9761

Classified Advertising Sales

Joan Wright, Tel. (800) 388-1820

Advertising Production Coordinator

Debbie Thomas, Tel. (513) 531-2690, ext. 219

SUBSCRIPTION SERVICES Subscription inquiries,
orders and address changes can be made at www.popwood.com (click on Subscriber Services). Or by mail:

Popular Woodworking,

P.O. Box 5369, Harlan, IA 51593 or call

(515) 280-1721. Include your address with all inquiries.

Allow 6 to 8 weeks for delivery.

NEWSSTAND DISTRIBUTION Curtis Circulation

Co., 730 River Rd., New Milford, NJ 07646,

(201) 634-7400, fax (201) 634-7499

Popular Woodworking (ISSN 0884-8823, USPS 752-250) is

published seven times a year in February, April, June, August,

October, November and December by F&W Publications, Inc.

Editorial and advertising offices are located at 1507 Dana Ave.,

Cincinnati, OH 45207; tel.: (513) 531-2222. Unsolicited

manuscripts, photographs and artwork should include ample

postage on a self-addressed, stamped envelope (SASE);

otherwise they will not be returned. Subscription rates: A year's

subscription (7 issues) is \$19.97; outside of U.S. add \$7/year.

Canada Publications Mail Agreement No. 0546232. Canadian

return address: 2744 Edna St., Windsor, ON N8Y 1V2

Copyright ©2000 by Popular Woodworking. Periodicals postage paid

at Cincinnati, Ohio, and additional mailing offices. Postmaster:

Send all address changes to Popular Woodworking, P.O. Box 5369,

Harlan, IA 51593 Canada GST Reg. #R122594716

Produced and printed in the U.S.A.

ATTENTION RETAILERS:

To carry Popular Woodworking in your store, call

(513) 531-2690, ext. 327, or write: Dealer Program, F&W

Publications, Inc., 1507 Dana Ave., Cincinnati, OH 45207.

Woodworker's Book Club: 1507 Dana Ave., Cincinnati,

OH 45207; (513) 531-8250

Audit Bureau of Circulation membership applied for.

Welcome, Scott Phillips

Our ongoing effort to bring you the best in woodworking “know how” has landed some pretty eye-popping, jaw-dropping talent over the last year or so. We’ve padded out the magazine’s professional editorial staff with a line-up of regular contributors who have proven themselves in the workshop and bookshop. You probably know I’m talking about finishing expert Bob Flexner and the jig meister himself, Nick Engler. Then, of course, there’s our work-a-day-world contributors Glen Huey and Troy Sexton, who show you how to build great projects using awesome techniques so you can construct your projects just like the pros.

Now, good friends and woodworkers-in-arms, I’m thrilled to officially welcome a very bright star to our group who’ll be sharing his woodworking wisdom in every issue, Scott Phillips, host of “The American Woodshop” PBS television series. You are in for a real treat.

Scott’s experience is as broad as it is deep. And believe me, there’s so much more to him than a TV personality who landed in a wood shop. Scott developed an early affection for woodworking and learned from his grandfather, starting at age 6. That’s when he built his first chair under an experienced, watchful eye. With a love of wood deeply ingrained, he later followed his father’s footsteps and became a forester after earning a forestry degree from Michigan State University. For years he was a roving veneer timber buyer for Hartzel Veneer of Piqua, Ohio, Scott’s home town. (Speaking of Piqua, the addition of Scott to the *Popular Woodworking* team completes what I jokingly call the Miami County, Ohio, woodworking triad, which also includes Nick Engler, a lifetime resident of West Milton, Ohio, and myself, a Troy, Ohio, native. We all grew up within 10 miles of one another!)

Scott was not content to merely roam the woods scouting out veneer-grade logs still on the stump, and started a retail woodworking store as well. Some time later, the store, a bit of an anomaly at the time, caught the eye of the Shopsmith company and soon Scott was working for



them developing the store concept and other woodworking tools. While there, he started producing videos to demonstrate the use of Shopsmith machines. Well, producing the videos and being the “on-camera” demonstrator lead to, guess what? The concept that eventually became “The American Woodshop” TV series. Today, the program is shown on public television stations all over the country and has been on the air for nearly a decade. If you have seen the show, you know that Scott emphasizes practical projects using safe techniques to produce quality woodworking. That combination makes Scott a great fit for *Popular Woodworking*.

In each issue Scott will share some of his hard-won woodworking tips and tricks, and he has a big bag full of them. His work will take over our long-running “Tricks of the Trade” column and is now called “Tricks of the Trade from The American Woodshop.” But don’t think for a moment that we aren’t interested in hearing from you about your best shop tricks. We will still publish at least one original reader trick and, are you ready? The prize is an incredible 12½" Delta portable planer. Yes, each issue the best trick of the trade from a reader will win this amazing prize.

So join me in welcoming Scott Phillips to the pages of *Popular Woodworking*. And be sure to keep sending us your own shop tips and tricks. We just might be sending a new Delta planer to you! **PW**

Steve Shanesy

CONTACT INFORMATION

Steve Shanesy

Editor & Publisher

Specialties: Projects, techniques, article and project selection
513-531-2690 ext. 238
steves@fwpubs.com



David Thiel

Senior Editor

Specialties: Projects, new products and tools, tricks of the trade
513-531-2690 ext. 255
davidt@fwpubs.com



Christopher Schwarz

Senior Editor

Specialties: Author liaison, website, projects, photography
513-531-2690 ext. 407
chriss@fwpubs.com



Jim Stuard

Associate Editor

Specialties: Projects, carving, turning, project illustrations
513-531-2690 ext. 348
jims@fwpubs.com



Tricia Barlow

Art Director

Specialties: Magazine and cover design, photo direction
513-531-2690 ext. 599
triciab@fwpubs.com



Got Questions or Problems With Your Subscription?

To report problems with your subscription visit our website at popwood.com, call our subscription offices at 515-280-1721, or write to *Popular Woodworking*, P.O. Box 5369, Harlan, IA 51593.

Our Privacy Promise to You

We make portions of our customer list available to carefully screened companies that offer products and services we believe you may enjoy. If you do not want to receive those offers and/or information, please let us know by contacting us at: List Manager, F & W Publications, 1507 Dana Ave., Cincinnati, OH 45207

SAFETY NOTE

Safety is your responsibility.

Manufacturers place safety devices on their equipment for a reason. In many photos you see in *Popular Woodworking*, these have been removed to provide clarity. In some cases we'll use an awkward body position so you can better see what's being demonstrated. Don't copy us. Think about each procedure you're going to perform beforehand. **Safety First!**

Western weather makes wood move differently

Wood in Coastal California Doesn't Shrink in Winter

Every time I see a reference to wood expanding in the summer and shrinking in the winter, I am briefly irritated. Your article in the June issue said it one too many times (Issue #115, June 2000, "The Way Wood Works").

Winter shrinking/summer expanding is true for you Eastern/Midwestern folk, but not everywhere. Where I live, in coastal California, wood expands in the rainy winter and shrinks in the dry spring and summer. I know this because my bathroom door sticks a little in winter, and flies open at a touch in the summer (in fact, it's already shrunk enough to stop sticking).

I'm sure there are other places in the country where this is true. In the future, please clarify that any statement about when wood shrinks isn't universal, but based on climate, so you don't mislead some young neighbor of mine.

Bill Houghton
Sebastopol, California

Editor's note: You are absolutely right and thanks for reminding us. The last thing we want to be is regional chauvinists. And I should know better. I lived in California for more than a decade before moving back to my native Ohio where I saw firsthand what real wood movement is.

Power to the People Who Power Their Own Tools

Thanks for the treadle lathe article by Roy Underhill! It's great to know I subscribe

to a woodworking magazine that recognizes the value of hand- and foot-powered tools. I am a huge fan of Roy and it is because of him and a handful of my grandfather's tools that I am a traditional woodworker. When I am not being a carpenter, I do my best at craft shows to show people that early technology is practical and efficient. It amazes me that every month *Popular Woodworking* has an article about some aspect of woodworking that I can apply to my own work. Keep up the great work and how 'bout some more articles by Roy!

Wilson Burnham
Allens Park, Colorado

Thanks for the Article on European Combo Machines

I read with interest the article on the combo machines because I have one. Mine is an Emco Star 2000, which I have been using since 1984. It was manufactured in Austria. I say "was" because I do not think it is being made anymore. Luckily, I have been able to get some parts through Blue Ridge Machine and Tools Inc. of Hurricane, W. Va.

The machine I have is capable of doing much more than the ones you wrote about. Mine is a circular saw, band saw, moulding maker, lathe, mortiser and has a flexible shaft tool. For my purposes, I use the circular saw and band saw most of the time.

The only drawback to the unit is that it draws 17 amps. I use it on a 15-amp circuit, and the circuit breaker will kick out

continued on page 10

sears

WE WANT TO HEAR FROM YOU

Popular Woodworking welcomes letters from readers with questions or comments about the magazine or woodworking in general. We try to respond to all correspondence. Published letters may be edited for length or style. All letters become the property of Popular Woodworking.

How to Send Your Letter:

- E-mail: Popwood@FWPubs.com
- Fax: (513) 531-0919
- Mail carrier:

Letters • Popular Woodworking • 1507 Dana Ave. Cincinnati, OH 45207

For
that
"SPECIAL"
project



Table
Bases



IN STOCK
NO
MINIMUM
VARIOUS
WOODS



FREE
COLOR
CATALOGUE

Kits Ready to Assemble &
Finish



Adams Wood Products™ L.T.D.,
P.O. Box 728, Dept. PW3
Morristown TN 37815-0728
Phone (423) 587-2942 • Fax 423-
586-2188

Circle #100 on Resource Directory Coupon

smithy

Circle #112 on Resource Directory Coupon

Shop Online

The widest
range of
woodworking
products
anywhere.

It's all at
rockler.com



Rockler
Bandsaw Table
and Fence, #24504.

ROCKLER
WOODWORKING AND HARDWARE

Code V1307

Circle #149 on Resource Directory Coupon

FREE! WOODWORKING CATALOG



Go to
rockler.com/v1310
and order your
FREE catalog
today! Or call
1-800-403-9736

Check out our complete
exclusive line of jigs and
shop tables for your band
saw, drill press and router.
PLUS thousands of other
great products!

ROCKLER
WOODWORKING AND HARDWARE

Code 11502

The NEW name for... The Woodworkers Store

ByPhone

ByFoot

ByNet

1-800-403-9736 1-877-ROCKLER www.rockler.com

Circle #150 on Resource Directory Coupon

LETTERS

continued from page 8

if the motor gets hot. I have learned to live with it.

Another problem is that the band saw blade is 59" long. I have to have them made by special order. I have found a place locally that will make them for about \$10 each. The blade diameter for the circular saw is 8". When you convert all this to metric, you can see the sizes would be normal in Europe.

All in all, it has been a good piece of equipment, and I can store it in the corner of my shop (garage) without much problem. Thanks again for an informative article.

Jim Tabb
via the Internet

Thickening Lumber Can Be Confusing for Beginners

When reading the article on the Morris Chair (issue # 115, June 2000) I was concerned because the plans do not discuss planing the wood down to the dressed dimensions.

If a beginner can make this chair they may be confused because getting to the finished thickness is never talked about in the article.

Jim Whalen
Lynchburg, Virginia

Editor's note: Thickening lumber can be confusing. And the following cannot be repeated enough: To do it right you need both a planer and a jointer. The jointer makes one face of the board flat, and the planer cuts the opposite face parallel to the first face. Planers alone generally cannot remove warp and twist from a board. And jointers cannot produce a board that has two flat faces that are parallel to each other. To do the work properly, you need both machines. PW

CORRECTIONS

In the "Folding Plant Stand" article in the August 2000 issue, one of the dimensions on the 3D drawing is wrong. The 8" dimension for the first riser should be 7 1/4".

In the "Scrapwood Scraper Plane" article in the same issue, the dimension of the side pieces is stated as 12" long. Though this dimension isn't critical, it should be closer to 9".



SPECIFICATIONS:

Makita 2012NB Planer

Street Price: \$499

Motor: 120v, 15amp, universal

Max. Cut: 1/8" high, 12" wide

Feed Rate: 27.9 feet per minute

RPM: 8,500

Table Size: 12" x 30 3/8"

Weight: 59.5 lbs.

Knives: 2, double-sided, disposable

Cuts per Minute: 17,000

Performance: ||||

Value: 1.11mm

Makita: 800-462-5482, or
www.makita.com

Makita's New Benchtop Planer Loaded With Features

In today's home wood shop, benchtop planers are fairly common. It wasn't that long ago, however, that only a couple were available, and Makita had one of the first. The 2012 (which you can still find if you look hard) brought stationary machinery performance to the home shop. Makita is now unveiling its updated version, the 2012NB, and it's a completely new machine. The most noticeable difference from the original 2012 is that instead of the table moving up and down under a fixed cutterhead, the table is fixed and the cutterhead moves — like most portable planers today. But there are lots of other changes as well.

Three amenities on this planer help you get to your finished thickness quickly. First, there's a depth-of-cut indicator that is a simple gravity-powered pin-gauge. As you place your lumber under the cutterhead, the pin rises to show you how deep your cut will be. On the right side of the planer is a depth stop, which allows you to dial in your finished thickness. For example, if you always thickness to 3/4", you simply set the depth stop and the cutterhead will stop at this thickness every time. It works

a lot like the depth stop on a plunge router and is quick to adjust, fine tune and move out of the way. Finally, the crank knob that adjusts your cut has a dial indicator to show you how much of a cut each turn of the knob produces, and this works hand-in-hand with the planer's depth scale, which is easy to read and adjust.

If you've ever worked with a benchtop planer, you know that some models can be difficult to adjust. However, the Makita is a snap to set up. First, all the tools to adjust the machine store in a box mounted to the motor. Adjusting the large infeed and outfeed tables is simple work using only an Allen wrench. And changing the double-edged disposable blades is the easiest system we've encountered. The cutterhead is held in place with an automatic lock that kicks in when you remove the dust shroud. The bolts to release the blade hold-down are easily accessible. And a groove in the blades aligns with the blade hold-down for quick and foolproof blade set-up. The system also allows you to move the blades side-to-side a bit to cancel out a nick in the blades.

The machine's case is beefed up with cross bracing and a cast aluminum top, all of which helps reduce snipe. Speaking of reducing snipe, unlike a lot of benchtop planers, the Makita 2012NB doesn't have a cutterhead lock. Instead, Makita has designed the 2012NB with a spring-mounted nut and screw design on the cutterhead to maintain pressure and control deflection.

So how does it work? After testing we're happy to say this is a very nice planer. Perhaps the best benchtop out there — by a nose. The cuts are smooth and nearly snipe-free in both figured oak and pine. However, the \$499 price tag may put this planer out of your reach. In fact, for just a few hundred more you can upgrade to a cast-iron floor model planer. But if your shop is limited in space or you need both portability and performance, this new Makita is your machine. For more information, circle #170 on the Resource Directory Coupon.

HOW WE RATE TOOLS

At *Popular Woodworking* we test new tools and products with an honest, real-world workout. We check for ease of assembly and determine how clear and complete the manuals are. Then we use the tool in our shop to build projects that appear in the magazine. Each issue the magazine's editorial staff shares its results and experiences with the tools, rating each for performance and value.

We use a one-to-five scale, with "five" in performance indicating that we consider it to be the leader in its category. For value, "five" means the tool is a great deal for the money,

while "one" means we consider it pricey. However, a tool with a low value rating may be worth the high price.

If our tool reviews don't answer all your questions, e-mail me at DavidT@FWPubs.com or call me at 513-531-2690, ext. 255. If we haven't reviewed the tool you're considering, there's a good chance I've used the tool, but simply haven't had a chance to write a review. Give me a call and see if I can help. You can also check out our past published tool reviews at our website: www.popwood.com.

—David Thiel, senior editor

TOOL TEST

Grizzly's Bargain Benchtop Planer

Setting up the G8794 takes a little more time and finesse than more expensive portable planers. But once you get the machine calibrated, the cuts are smooth and relatively snipe-free. For less than \$300, the G8794 comes with a depth scale, adjustable infeed and outfeed tables and double-sided disposable blades. You set the knives using springs and a setting gauge, which is more time consuming than the simpler systems on Delta's 22-560 and Makita's 2012NB. Plus, to adjust the infeed and outfeed tables you need to fiddle with a two-nut system, which again takes time to master. However, the tables have steel rollers on the leading edges, which help move the stock under the cutterhead. As a nice bonus, Grizzly throws in a sturdy tool stand with the machine. If you're watching pennies and you're willing to forego some amenities, the G8794 should be on your short list.



SPECIFICATIONS:

Grizzly G8794 Planer

Street Price: \$280 plus shipping

Motor: 110v, 15amp, universal

Max. Cut: 1/16" high, 12 1/2" wide

Feed Rate: 25 feet per minute

RPM: 8,540

Table Size: 12 1/2" x 23 5/8"

Weight: 75 lbs.

Knives: 2, double-sided, disposable

Cuts per Minute: 17,080

Performance: 111mm

Value: 111m

Grizzly: 800-523-4777, or
www.grizzly.com

For more information, circle #171 on the Resource Directory Coupon.



SPECIFICATIONS:

RP200/RP400K

Plunge Routers

Street Price: \$69/\$99

Motor: 1hp-9.5 amp/2hp-10amp

RPM: 25,000/0-25,000

Dust Extraction: Through the base

Weight: 8 lbs./8.75 lbs.

Collet: 1/4" with spindle lock

Soft Start: Yes

Rack & Pinion Height Adj: No/Yes

Performance: 111mm

Value: 111m

Black & Decker: 800-544-6986, or
www.blackanddecker.com

Black & Decker Entry-Level Plunge has a Great Price

We love the DeWalt DW621 plunge router and all its fine features, including the well-designed dust collection system. Now DeWalt's parent company, Black & Decker, has put many of the 621's features on its new RP200 and RP400K plunge routers. And the price tag is amazing (\$99 for the variable speed model, \$69 for the single speed). Overall, we found the performance of these routers to be good. The spindle lock, variable speed and soft start are handy, and the router plunges smoothly. Though the routers are available with only a 1/4" collet, that's OK for an entry-level tool. We wish the rack-and-pinion depth stop on the RP400K also had a turret depth stop, but the system works fine as is. One of the things that excited us about these routers was the built-in dust collection. Unfortunately during testing we found that the dust collection was not as good as on the sister DeWalt model, perhaps because the base is larger and more open than on the 621. Despite this, any dust collection is better than none, and these routers are a great value for any entry-level woodworker.

For more information, circle #172 on the Resource Directory Coupon.

TOOL SCOOP



With the SawStop device installed, this hot dog received only a scratch from the spinning saw blade.

REVOLUTIONARY SAWSTOP MAY CHANGE THE WOODSHOP

What do you get when you cross a Ph.D., a patent attorney and a woodworker? In Stephen Gass' case you get a table saw attachment that could revolutionize shop safety forever. Gass is the inventor of SawStop™ (www.sawstop.com), a safety device that stops the spinning blade of a table saw in 2 to 5 milliseconds when it comes in contact with the human body. That's less than a quarter-turn of the blade, and that's fast enough to turn a serious accident into one requiring a household bandage.

SawStop reacts to the electrical capacitance of the human body, and it recognizes the difference between flesh and wood. Think of those table lamps that turn on and off when you touch the base. It's the same idea. Wet wood won't trigger the system, though metal-clad materials will, so a bypass switch is included. Once the signal is interrupted, the mechanism (mounted under the table of the saw) releases a thick piece of polycarbonate into the teeth of the blade to stop it. The system works with all conventional saw blades without modifications, and the cartridge is easily replaced after the system is triggered. The system can be sold with a new saw, or as a retrofit to existing saws. Gass is in discussions with a number of woodworking tool manufacturers, hoping to offer the SawStop to all, rather than as a proprietary item. He tells us the price of the system should only increase the cost of a machine between \$30 and \$100. Gass says the system will be expanded to radial arm saws, jointers and other tools in the future. Look for a review of this potential leap forward in woodworking safety in an upcoming issue.

TRICKS OF THE TRADE FROM THE AMERICAN WOODSHOP



Illustrations: John McCormick

GREETINGS FROM 'THE AMERICAN WOODSHOP'

I'm Scott Phillips, host of the PBS program "The American Woodshop" and contributing editor to *Popular Woodworking*. Every issue I share some of my favorite tips, tricks and great woodworking ideas I've collected over the years. Some will be basic helpful hints, while others are just good common sense solutions to everyday problems. In addition to my ideas, we'll pick the best tip or trick sent in by a reader and publish it on these pages as well. We're happy to have Delta Woodworking Machinery as the sponsor for the Tricks of



The Trade column, and they'll award an outstanding model 22-560 12½" bench-top planer (shown at left) to the best "trickster."

To submit your tip or trick, either e-mail it along with a daytime phone number to DavidT@FWPubs.com or mail it to: Tricks of the Trade • *Popular Woodworking* • 1507 Dana Ave. • Cincinnati, OH 45207. All entries become the property of *Popular Woodworking*.

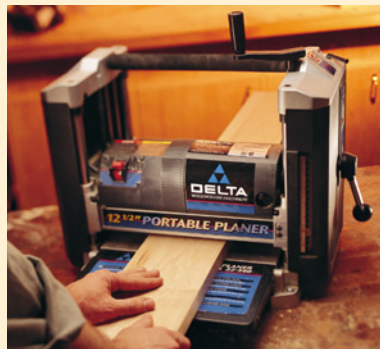

THE WINNER:

Having a Direct Bearing on Your Work

I've done a lot of template and radius work over the years and often need to band saw a shape out, leaving just a bit of wood for the shaper or router to clean up in the final milling. Well, it gets a bit challenging trying to keep a nice even offset just by eye (especially as my eyes are changing with time). So what works beautifully is to use an old router bit bearing, put your pencil in the hole and just slide the bearing around your form, giving you a perfect even offset line to cut to. It also works great for scribing a fit to a wall. And you can use different bearings for different sized offsets as needed.

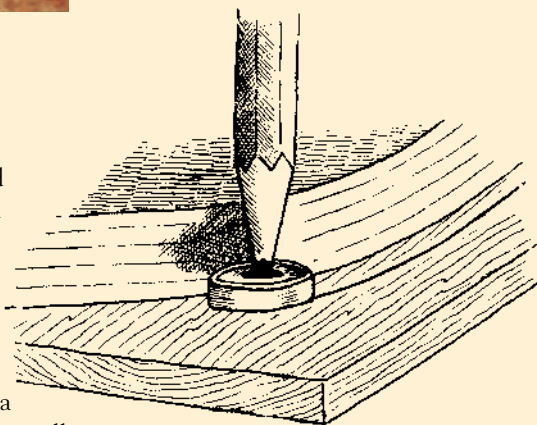

*Sangeet Henry
Fairfax, California*

Double-Stick Duplication

One of the best tricks in my shop is using double-sided tape to cut out identical parts on the band saw. Simply use several 3"- to 4"-long pieces of professional-quality double-stick tape (I use Spectape brand) to temporarily join the workpieces together. To improve the hold of the tape, always apply clamping or vise pressure on the "joined" workpieces before using power tools on them. And just because you're done cutting, don't take the pieces apart. Sand all the parts while they're still stuck together. To separate the pieces, use a thin-edged screwdriver to gently wedge the workpieces apart. If they're stuck pretty tight, use a heat gun or a blow dryer to warm up the workpieces. The hot air will make the stubborn bonds release. A word to the wise, you should never use double-stick tape to hold parts together for turning. I believe there is too much risk of a separation during turning to safely complete certain projects.

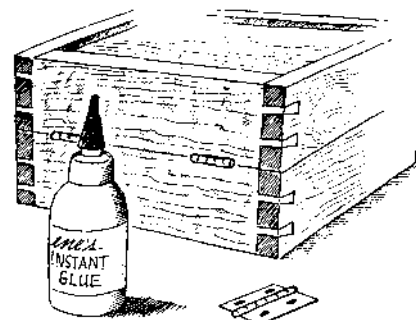

Sticky Solution to a Slippery Problem

Setting box hinges can be tough, but this tip will help. Use thick-viscosity (cyanoacrylate) Super Glue to temporarily hold the hinges exactly where they belong. Start by first using 100 grit sandpaper to rough up the unseen parts of the hinges. This gives the glue something to stick to while you move the hinges where they belong. Make sure the barrel of the hinge is placed to provide full movement before the glue sets. Just use a couple drops of cyanoacrylate on each sanded surface to bond the hinge temporarily in place. Using a spray accelerator will speed up the initial curing to a matter of seconds. Then gently open the hinge (with the box lid or door in place) and use Vix bits to predrill the pilot holes for your screws. If the hinge needs to be mortised into the box sides, use a scratch awl to scribe in the hinge profiles before you remove the temporarily "glued" hinge. Next use the edge of a sharp putty scraper (or an inexpensive chisel) to separate the hinge from the wood. Chisel the mortise to the layout line and mount the hinges. This will work every time. Remember to go easy on the glue. If you get the glue into the hinge barrel, you've used too much. The solvent sold to clean up cyanoacrylate glue will dissolve all unwanted glue.

continued on page 20

continued from page 18

Scrollin' on the Band Saw

Sometimes a scroll saw doesn't have enough power for the project I'm working on, but I still need to make tight turns and small radii. When this happens I head for my band saw — after I give it a proper tune-up. First, after unplugging the band saw, I fit it with a $\frac{1}{8}$ "-wide silicon carbon steel band saw blade that has 14 teeth per inch. Tune this blade properly on the band saw by first tensioning to the $\frac{1}{8}$ " setting on the tool. This tensioning scale gets you in the ball park. Second, back away the thrust bearings and guide blocks so absolutely nothing touches the blade. Third, adjust the tracking mechanism on the saw to position the band saw blade on the middle of the tire on the top band saw wheel. Fourth, replace the metal guide blocks with Cool Blocks (resinous fiber blocks that are designed to gently touch and support the blade during the cut). Adjust the Cool Blocks so the leading edges are flush with the front teeth of the blade. This actually captures the entire width of the blade in the Cool Blocks. Gently press the blocks to the blade and lock all blocks in place. Do not put side pressure on the blade during this process. The blade must stay centered in the guide block assembly to work properly. Do not tighten the blocks against the blade to the point that they bind the blade. Fifth, readjust both thrust bearings (above and below the table) so they are within a hair (about five-thousandths of an inch) of the back of the blade at rest. Finally, just follow all other procedures described in the band saw manual and scroll away. Experiment by adding or decreasing the tension on the blade and make a series of test cuts. Remember to keep your fingers and hands safely positioned at all times. Soon you will discover that perfect tension and you'll be amazed at the accuracy of your cuts.

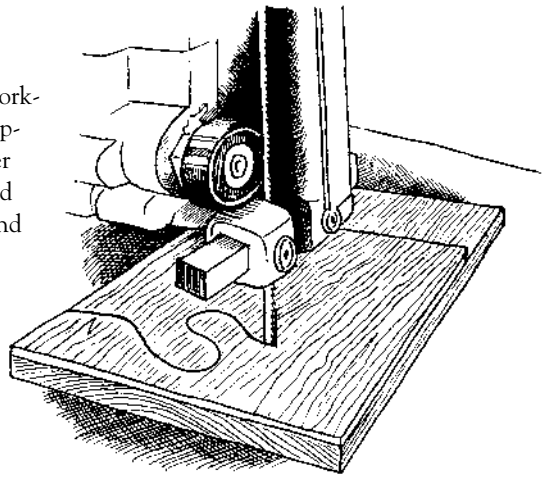

continued on page 22

jds

TRICKS OF THE TRADE

continued from page 20

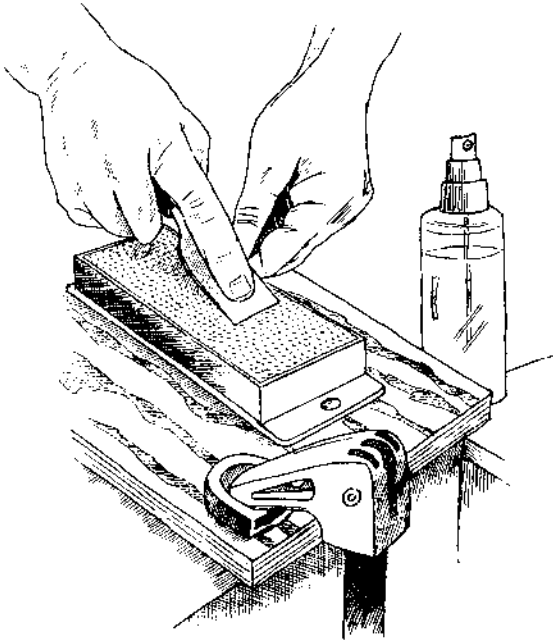

The Secrets of Successful Sharpening

I like the K.I.S.S. approach to sharpening — Keep It Seriously Sharp. Dull tools can't work properly, and you can't work properly with dull tools. Diamond sharpening stones now make sharpening bench chisels easy and fast. Secure a fine diamond stone (600 grit) to a base board then clamp this to a workbench. Always buy the biggest sharpening stone you can afford. I prefer stones that are at least 2" x 6" or larger. These larger stones allow long, fluid motion across the surface of the diamonds. Remember, the secret to sharp edges is to make the bevel flat and shiny from the heel to the cutting edge. To guarantee this, you need to duplicate the angle of the bevel. If you simply learn to hold the flat of the bevel flat to the surface of the sharpening stone you will generate a great bevel. I believe the easiest way to learn this is by practicing freehand on your diamond stone. Alignment jigs and honing guides are OK, but hand skills can easily be learned to produce keen edges. Cradle the blade with both hands and press the bevel flat to the surface of the fine stone. All diamond stones should be misted lightly with water from a spray bottle. Add just enough water (10 drops or so) to lubricate your cut and carry away the metal particles (which some call "swarf.") My best advice here is to make long fluid strokes with the bevel of the chisel, pressing all water out from underneath the bevel during your strokes. Look closely at the cutting edge and you will see water scooting like a miniature wave on the stone's surface. When you see this, you're on your way to a seriously sharp edge. Hone the edge to remove the fine wire-like burr by using fine hard Arkansas oil stones or the extra fine diamond stone. I like to hone by pulling the chisel toward me rather than pushing it away from me. Once the burr is gone the chisel will be razor sharp. **PW**

©2000 R. J. REYNOLDS TOBACCO CO.



powermatic

Circle #136 on Resource Directory Coupon



Doral Full Flavor

13 mg. "tar", 0.8 mg. nicotine av. per cigarette by FTC method.

**PACKED
TIGHT
BURNS
SLOW™**



**SURGEON GENERAL'S WARNING: Cigarette
Smoke Contains Carbon Monoxide.**

The Basics of Coloring Wood

The keys to understanding finishes.

So you've completed your project and now you want to color it so it matches another object, a color chip or a vision you have in your head. Achieving this match can be one of the most difficult tasks in wood finishing, but before you get into the actual mixing of colors, it helps to understand what's possible and know the "tools" you have at your disposal.

The Wood

Any color can be matched, but not any wood. You have to pay attention to how the wood or woods you're finishing compare to the sample you're trying to match.

There are four large categories of woods: softwoods such as pine and fir; tight-grained hardwoods such as maple, birch and cherry; medium-grained hardwoods such as walnut and mahogany; and coarse-grained hardwoods such as oak and ash.

Within each of these categories, you can pretty successfully match any two woods using some combination of bleach and stain. But trying to match woods of two different categories has its limitations because of the large differences in grain and figure. You should take these limitations into account when you're choosing the wood for your project.

Types of Stain

The basic way to change a wood's color is to apply stain. In choosing a stain, you need to take into account the four ways in which they differ besides the obvious variances in color.

• **Type of colorant:** There are two types of colorant used in stains: pigment and dye. Pigment is finely ground natural or synthetic earth. Dye is a chemical that dissolves in a liquid. Everything that settles to the bottom of a container is pigment, and all the color that remains in the liquid after the pigment has settled is dye.

Pigment is better at highlighting grain

if the excess is wiped off, and at obscuring the wood if the excess is left in any thickness on the surface. Dye is better at changing the color of wood without muddying it — especially dense woods such as maple. Some stains contain only dye, some contain only pigment, and some contain both.

• **Amount of colorant:** Stains differ in the ratio of colorant (pigment and dye) to liquid (thinner and binder). The higher the ratio of colorant in the first coat you apply, the darker the stain will make the wood. You can control how dark you color the wood in one application of stain by adding pigment or dye to increase the ratio or by thinning to decrease the ratio.

• **Type of binder:** Most stains contain a binder, which seals the pigment or dye into the wood or onto its surface. Binders are oil, alkyd, oil/alkyd or water-base finish. The biggest difference among binders is drying time — oil dries slowly, alkyd and water base dry rapidly. But also important is water-base stain's characteristic of raising wood grain. Some dye stains, usually identified as "non-grain-raising" (or NGR), "water-soluble," or "alcohol-soluble" don't contain a binder.

If a stain contains a binder, every coat after the first remains on top of the wood; it doesn't go into the wood. Pigment in these stains obscures the wood if some is left on the surface. Dye in these stains is fairly transparent. Dye without a binder continues to add color into the wood and darken it more with each coat.

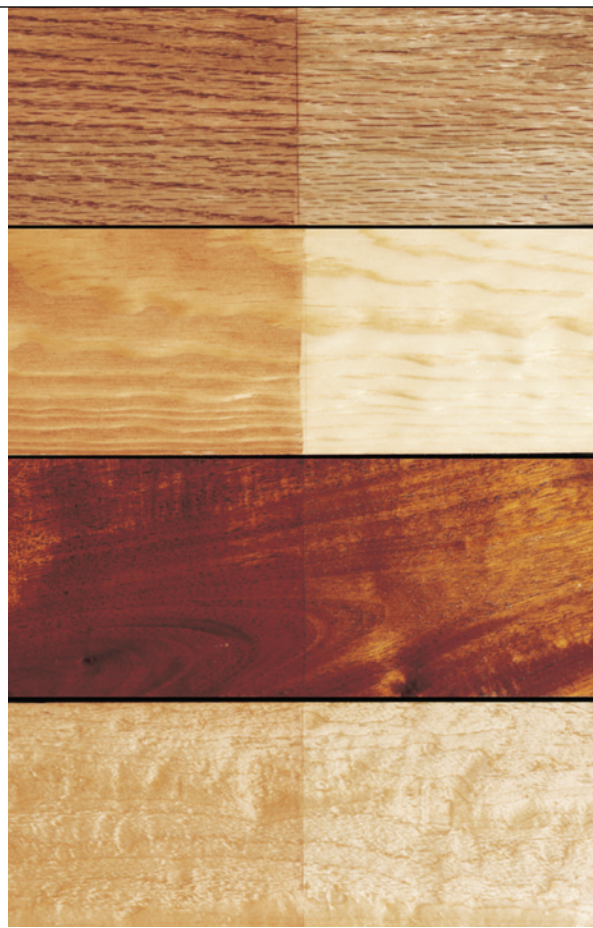

The same stain was applied to the left side of each of these woods — from the top down: oak, pine, mahogany, maple. Yet each still looks like the wood it is. There are limitations in what you can accomplish making one wood look like another.

If you apply a pigment or dye stain over a sealed surface and leave it, the stain is called a toner or shading stain.

• **Thickness:** Most stains come in liquid form for fast and easy application, but some are thick gels. Gel stains are useful for reducing blotching on woods such as pine and cherry, because gels don't penetrate into the wood.

Just as with liquid stains, the color in a gel stain can be adjusted by adding pigment to darken or tweak its color, or by adding a clear gel finish to lighten its color.

Gel stains are usually labeled as such, but manufacturers rarely provide much information about the type or amount of colorant or binder. To a large degree, you have to experiment and learn by trial and error, and this is the primary reason many people find staining so problematic.

Application Methods

The basic way to apply a stain is to wipe, brush or spray a wet coat onto the wood,

continued on page 26

FLEXNER ON FINISHING

continued from page 24

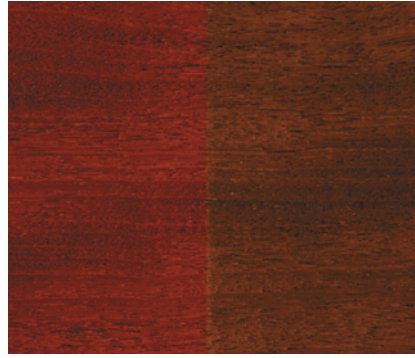

A green toner was applied to the right side of this mahogany to “kill” the red and turn it brown. Toners can be used to adjust color after the application of a stain.



A full-strength stain was applied to the left side of this oak. The same stain thinned half with paint thinner was applied to the right side. The ratio of colorant (pigment and dye) to liquid (thinner and binder) determines how dark the wood will be.

dremel

then wipe off the excess before it dries. This will produce an even coloring as long as the wood isn't naturally blotchy and you have prepared it well.

Other ways to apply color include the following.

- Spray on a stain and leave it (called “toning” or “shading”). You can spray an entire surface to produce an even coloring, or you can limit the spray to parts (for example, just sapwood) to correct an uneven coloring in the wood or create special effects. You should thin the stain with four-or-more parts thinner to prevent lap marks.

You can also tone or shade using a brush, but it's difficult to keep the coloring even.

- Partially seal or “washcoat” the wood before applying a stain. A washcoat is any finish, sealer or white glue that is thinned to approximately 3 to 7 percent solids so it seals the wood just enough to prevent deep stain penetration and the resulting blotching on some woods.

Most finishes are 20 percent to 35 percent solids right out of the can, so thinning the finish 5-1 usually gets you in the ballpark.

When staining large or multiple objects, using a fast-drying, sprayed-on washcoat followed by a liquid stain is more efficient than using a gel stain, but experimentation and practice are necessary to learn the right amount of washcoat to apply. A gel stain is far more predictable.

Slow-drying washcoats, called “stain controllers” or “wood conditioners” are de-

signed for wipe and brush application, but they also take experience to use successfully.

- Seal the wood with a sanding sealer or first coat of finish and apply a glaze to create a special effect. (See *Popular Woodworking*, April, 2000, page 76.) A glaze is a pigmented stain thickened enough so it stays where you put it. You can use rags, brushes or specialized glazing tools to manipulate the glaze. Once you have the look you want, let the glaze dry, then coat over it to protect it from being scratched or rubbed off.

- Seal the wood with a sanding sealer or first coat of finish and spray on a toner or shading stain to change the color of the wood or highlight parts of it. Toners and shading stains (the terms are often used interchangeably) are very useful for tweaking a color to an exact match.

Remember that a pigmented toner obscures wood while a dye toner doesn't, and that over a sealed surface, toners and shading stains add color but don't bring out the wood's figure.

Conclusion

Every color-matching situation is different, and many are very challenging. Once you've determined the degree the wood will allow you to be successful, achieving a good match involves choosing types of stains and methods of application in addition to choosing the right color. **PW**

Bob Flexner is a nationally known finishing expert in Norman, Oklahoma, and the author of “Understanding Wood Finishing.”



Measure & Mark
 Wood Fabric
 Drywall Concrete
 Maps Sheet Metal...
 Draws a 3 1/2" to 6 ft. Radius and Parallel Lines

\$29.95 ea.
 FREE shipping!

1-877-6Rotape™
 www.rotape.com

Send check or money order to:
 Brat Mfg., Inc.
 P.O. Box 200
 Ada, Ohio 45810

Circle #142 on Resource Directory Coupon

s. larose

Circle #143 on Resource Directory Coupon

FACTORY DIRECT PRICES **FREE CATALOG**

Call
1-800-642-0011
 Mention offer
7521 for a free catalog

- ◆ Grandfather Clocks
- ◆ Mantel & Wall Clocks
- ◆ Clock & Furniture Kits
- ◆ Satisfaction Guaranteed

Emperor Clock, LLC
 PO Box 1089 Dept 7521
 Fairhope AL 36533
 www.emperclock.com

Circle #102 on Resource Directory Coupon

A Treasured Family Heirloom Just Waiting to be Discovered!

This Granddaughter Kit is adorable at just 5 feet tall!
 Ashley Granddaughter Kit 34921...\$459.95

New Fall 2000 Catalog - Over 80 NEW PRODUCTS

- Including 15 New Kits
- Tools & Finishing Supplies
- Finished Clocks & Watches Including the **Amazing New Atomic Time Technology!**
- Personalized Clocks

FREE* CATALOG!
 Mention DEPT. PW110
 *(Canada \$2 • Foreign \$5)

From start to finish, Klockit has it all!

- Quality Clock Kits For All Skill Levels
- Clock Components - Quartz and Mechanical
- Music Movements & Boxes
- Dials, Hardware, Finishing Supplies & More!

Department PW110
 1-800-KLOCKIT
 www.klockit.com **KLOCKIT®**

Circle #105 on Resource Directory Coupon

MOBILIZE WITH THE ORIGINAL

Invented in 1980, our mobile bases have revolutionized workshops worldwide. Why settle for anything less than the original premium mobile base from HTC.

The benefits of a mobilized workshop:

1. move machines with ease
2. easy workshop clean-up
3. create more room for more tools
4. gain valuable space
5. put machines where you need them
6. buy them once...Lifetime warranty

FREE Color Catalog
 Call: 1-800-624-2027
 HTC PRODUCTS, INC.,
 ROYAL OAK, MI 48068-0839

"We'll put these bases under our machines anyday."
 -Wood Magazine, Dec 1998

THE HALLMARK OF QUALITY
HTC
 MADE IN USA

Circle #104 on Resource Directory Coupon

Ask a HAWK Scroll SAW owner

Meet Tommy Bradley who uses his Hawk Scroll Saw to create projects using intarsia. The color variations in Tommy's projects come from individual pieces cut from woods that are native to his home state of Iowa. He doesn't use stains or paint. Tommy's favorite woods to cut include maple, hackberry, cedar, cherry, walnut, and bass.

Since receiving his Hawk Scroll Saw as a holiday gift from his wife, Tommy has completed over 300 intarsia projects. Some projects have as many as 800 individual pieces. One of Tommy's projects can sell for as much as \$3,500.

Tommy confesses that TV hasn't been very interesting since he got his Hawk Scroll Saw and prefers to be in the garage making projects rather than sitting in the recliner.

When asked about his Hawk Scroll Saw Tommy says, "I have seen other scroll saws, but you couldn't trade me out of my Hawk. You couldn't ask for better service, the people at RBI are great!"

Learn why craftsmen like Tommy Bradley choose the Hawk Scroll Saw for their workshop.

Call Toll Free and get a Free Fact Kit
1-800-487-2623
 rbi industries, inc.
 PO Box 369, Harrisonville, MO 64701
 www.rbiwoodtools.com

No Risk 30 Day Trial

Circle #111 on Resource Directory Coupon

THE Best New TOOLS OF 2000

This is always our favorite issue each year.

It's the opportunity we have to congratulate woodworking tool manufacturers for innovative designs and tools.

It's also a great opportunity to recommend quality tools to our readers. Some of our recommendations are for quality of design, some for excellent performance and others are for value or just a really clever idea. All of the tools considered have become available within the 2000 calendar year. While some of these tools may have been unveiled in 1999, they weren't available to the general public until 2000. As you shop for tools this year we hope you'll consider our shopping suggestions. And we hope tool manufacturers will take these awards as support of their innovative work and appreciation for their efforts. Congratulations, and keep the good tools coming.

By David Thiel and Christopher Schwarz

Makita
Grizzly
Metabo
Porter-Cable
DeWalt
Black & Decker
Knight Toolworks
American Tool
Senco
Dremel





MAKITA'S NEW FIXED-BASE ROUTERS

With the introduction of the 1100 and 1101 series routers this year, Makita has regained its reputation for building top-quality routers. These four new tools (offered in variable and fixed speeds, and in a D-handle or straight base) are well designed, packed with power and easy to use. Fueled by an efficient 11 amp (2¼ hp) universal motor in a small and lightweight package (less than 8 lbs.), these tools offer soft-start technology, low vibration and electronic speed control to maintain maximum torque. Operating at about 81dB, these routers are quiet (though you still need hearing protection). In our opinion these machines have the easiest height adjustment mechanism on the market today. The pressure buckle release on the base is smooth, and the motor spins up and down in the base with ease, even after months of use. Other features include an 8-foot rubber power cord, externally accessible brushes and both ¼" and ½" collets. These routers are a pleasure to use. And though they carry a higher price (\$200 to \$240) than some competing tools, they're well worth the money.



Contact Makita at 800-4MAKITA or www.makitausa.com

GRIZZLY'S BARGAIN CABINET SAW



Grizzly sneaked this tool into its 2000 catalog before we heard about it, and all we could say was, "wow!" The G1023S is a variation on an existing Grizzly cabinet saw, but the addition of a Biesemeyer clone fence system made us jump to test it. The 3hp (18 amp), 220 volt saw, priced at \$755 (plus shipping), surpassed our expectations. Sporting two solid cast iron wings, a better than average miter gauge with adjustable T-bar and both a standard and dado blade insert, we couldn't wait to plug it in. Assembly went very well with only slight adjustments to bring it into spec. Grizzly deserves high marks for the fit, finish and performance of the saw. A 2hp model (G1023S-110) that will run on 110 power is also available for about the same price. Both saws are a really great value, so anyone considering a contractor saw can now step up to a cabinet saw for about the same price. With the increased performance, a quality rip fence, a solid cabinet-mounted trunnion support for the blade and the low price, this saw is truly a Best New Tool for 2000.

Contact Grizzly at 800-523-4777 or www.grizzly.com

NEW METABO JIGSAWS ARE WORKHORSES

Most U.S. woodworkers have probably never heard of Metabo, which is German for "metal boring." But that should change soon. The company based in Nürtingen, Germany, has a new line of jigsaws that rival (and some might say surpass) the great jigsaws produced by another German company, Bosch. The STE105 and STEB105 jigsaws are simply outstanding tools. The jigsaw we tested produced clean, splinter-free cuts in a variety of hardwoods and softwoods. The two models (one's a barrel grip the other's a top-handle design) are both powered by a 6-amp motor, have five orbital settings (which control how aggressive the cut is) and an impressive 1" stroke, which is the length the blade travels. The blades are held in place with a spring-mounted clamp. Pull a lever back and the blades comes free — no screwdrivers or hex keys necessary. Dust collection is superb. The business end of the saw has a clear plastic shroud that directs the dust back to the port at the rear of the machine. You're also probably wondering how this tool will hold up. One of our contributing editors has been using a Metabo jigsaw almost every day in his cabinetshop for more than a year and reports that the tool is nearly indestructible. At \$219, the Metabo might just be the last jigsaw you ever need.



Contact Metabo at 800-638-2264 or www.metabousa.com

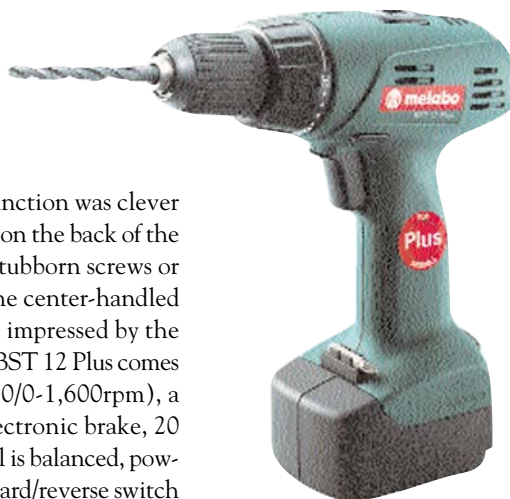

Contact Metabo at 800-638-2264 or www.metabousa.com

METABO IMPULSE DRILL

When we tested Metabo's BST 12 Plus we thought its "impulse" function was clever and useful, but not reason alone to buy the tool. By flipping a switch on the back of the drill, the motor pulses in either forward or reverse to break loose stubborn screws or start screws or holes without letting the bit "walk." Then we put the center-handled 12-volt drill/driver through its paces for several months and were impressed by the overall performance of this German tool. Selling for about \$215, the BST 12 Plus comes with two 2-amp-hour NiCd batteries, a two-speed gearbox (0-450/0-1,600rpm), a 1/2" single-sleeve keyless chuck, variable speed control with an electronic brake, 20 clutch settings and a whopping 466 inch/lbs. of torque. In all, the tool is balanced, powerful, sensitive and a joy to use. One quirk of the drill is that the forward/reverse switch works the opposite from what is the industry standard. Left-handers will, as a result, love this drill. For the rest of us, it's worth getting used to.

REVAMPED COMPRESSORS

The market and not yet reviewed in *Popular Woodworking*, Porter-Cable has modified its line of compressors with dramatic results. By changing both the turn-on and turn-off levels for the machines and increasing the maximum psi ratings, an air tool attached to these compressors can operate longer before the machine kicks on, and the replenish the air in the tank sooner without a drop in pressure. These are simplified versions of the improvements, but suffice it to say the new compressors provide better performance by 28 percent to 140 percent on 15 psi rated tanks. We're fond of the whole line, but in particular the 5.7cfm@90psi and 6.8cfm@90psi models (CPL6025 (\$249)), which offers 6.8cfm@90psi with a 2-hp motor — and at a better price.



Contact Porter Cable at 800-487-8665 or www.porter-cable.com

DEWALT'S DW746 STATIONARY TABLE SAW

Though first shown to magazine editors in 1999, the DW746 wasn't really available until early 2000 when we had our chance to put it through its paces. There may be some confusion as to what category this saw falls into, but after some discussion we've decided to consider it a contractor saw with some nice cabinet saw features. Boasting a 1 3/4 hp (15 amp) spring-tensioned, belt-driven motor mounted inboard of the base, the DW746 (\$900) offers a good quality cut in hardwoods with little vibration. The inboard motor reduces the footprint of the saw for smaller shops, and an enclosed shroud around the blade assembly allows for the best dust collection in a contractor saw that we've ever seen. Two heavy-gauge stamped steel wings are standard on the base model. The rip fence is a T-style fence with good accuracy and repeatability, and the fence face can be moved forward or back to improve stability in unusual cuts and setups. DeWalt also offers a sliding table accessory (\$400) that is a great addition. Though slightly more expensive than the competition, this is a saw any woodworker should welcome into the shop.



Contact DeWalt at 800-433-9258 or www.dewalt.com



BLACK AND DECKER'S PLUNGE ROUTER

One of the most vexing questions for beginning woodworkers is which router they should buy. The answer to that question just got a lot simpler with the introduction of the Black & Decker RP400K plunge router. Priced at a paltry \$99, this router shares a lot of features with its professional cousin, the DeWalt DW621, which is a thoroughbred among plungers.

The RP400K has variable speed, dust collection, a rack-and-pinion depth stop, soft start and a spindle lock on its 1/4" collet. No other plunge router on the market has all these features for this price. Add to that an oversized base (which makes the tool more stable and easy to use for beginners) and you have a router that novice woodworkers should flock to. You can also use this tool in a router table, though like most plunge routers it can be fussy to adjust up and down.

Black & Decker has been making an effort to burnish its image lately with a handful of well-designed inexpensive tools including the RP400K, Firestorm drills, a scroll saw and new chop saws. And we woodworkers are the clear winners.



Contact Black and Decker at
800-544-6986 or
www.blackanddecker.com

MAKITA'S 2012NB BENCHTOP PLANER

We've seen a lot of benchtop planers come through our shop, and we've watched them get better every year. This year's standout is the Makita 2012NB, which comes closer than any other benchtop planer to producing a perfect snipe-free finish. It's also bristling with features, such as a depth stop that gets you to the same thickness every time, two depth-of-cut indicators, on-board tool storage, easily adjustable infeed and out-feed tables (finally!), blades that change quickly and easily and a motor that will take almost an 1/8"-deep cut on a 6"-wide board.

What you won't find on the Makita planer is a cutterhead lock. Relax. The 2012NB uses a new spring-mounted nut on the cutterhead to reduce snipe. It works really well. All of this comes at a price, of course. At \$500, the Makita 2012NB is just about the most expensive benchtop planer on the market today. Is it worth it? If you have limited shop space and can't afford a floor model planer, or you need a planer that can go anywhere but produce professional results, the 2012NB is your new best friend.

Contact Makita at 800-462-5482 or www.makita.com

WOODEN PLANES FOR A GREAT PRICE

Wooden-bodied handplanes aren't for everyone, but if you're interested in hand tools or passionate about hand planes, you should try one of the planes made by Steve Knight and his small operation in Portland, Ore.

We were particularly impressed with his 9" finish plane (some would call it a smoothing plane). For just \$95 you get a plane made from white oak with an Ipe sole and an ebony strikeplate. The iron is 2" wide, an impressive 1/4" thick and is really something special. Hardened to a Rockwell hardness of 62 to 64 (that's about as hard as you'll ever need), these irons are then cryogenically frozen to give more use between sharpenings. Thanks to an adjustable throat and the angle of the beefy iron, you can plane even the wildest curly maple with minimal tearout using this plane.

If you've never owned a wooden plane, it takes some time to learn how to set it up. But once you do, we think you'll turn to this tool more and more as you prepare your stock for finishing. By the way, Knight has other planes for sale on his website and will do custom work.



Contact Knight Toolworks at
503-771-6180 or
www.knight-toolworks.com



QUICK GRIP'S NEW ADVANTAGE CLAMP

We've relied on the one-handed Quick Grip clamps since their inception several years ago. And now we're pleased to see American Tool expand the line with the Quick Grip Advantage, which merges a one-handed clamp with a F-style clamp. As a result, the Advantage line offers the best of both worlds: an easy-to-use clamp that can put the squeeze on your work. With a reported 600 lbs. of clamping force, the Advantage clamps stand up to all but the most strenuous clamping tasks, while the non-marring pads on the swiveling jaws allow the clamp to tighten without sliding pieces out of parallel from one another. Available in 6", 12" and 24" lengths, we expect the Advantage clamps to sell for about \$35 for the 24" clamp. While a similar clamp that offers more substantial clamping pressure is available from a competing manufacturer, the Advantage clamp is easier to use and less expensive, while its mostly steel construction promises long life. This is a nice new addition to the line and a tool improvement we're happy to recommend.



Contact American Tool at 800-866-5740 or www.quick-gripclamp.com



Contact Senco at 888-222-8144 or www.senco.com

SENCO'S FINISHPRO 25 WITH 2 1/8" CAPACITY

We've spent the past couple of years praising Senco's line of air tools for the home woodworker, Accuset, so we're pleased to give high marks to a new addition to the company's flagship line this year. The FinishPro 25 brad nailer is the first 18-gauge brad nailer capable of firing 5/8" - to 2 1/8"-long brads into the hardest of woods. This is accomplished with a "turbo" feature, which increases power by 30 percent for driving the really long brads. While it is a small job to turn the turbo feature on with an Allen wrench, most users will set the turbo feature in either the high or low setting and leave it there. Other features include a lightweight design, oilless operation, adjustable depth-of-drive, on-board wrenches and a clever lock-out function that will not allow the nailer to fire if you are out of brads — no more blanks that you think are holding the work. Selling for \$199, the FinishPro 25 is a nice advance in the brad nailer industry, and another feather in Senco's cap.

DREMEL'S WELL-APPOINTED SCROLLSAW

Serious furniture builders need a scrollsaw, yet they don't need a top-of-the-line Hegner, Excalibur or RBI. Instead, they need an easy-to-use saw for cutting both fretwork and templates for pattern-routing that doesn't cost as much as a table saw. The Dremel 1608 is just such a tool. For less than \$200 you get a benchtop scrollsaw that is packed with great features and makes smooth cuts in both solid wood and plywood.

Here's what you get: a 1/6 hp variable-speed motor that operates between 500 and 1,600 strokes per minute. A 12" x 16" cast iron table that tilts 45 degrees both left and right. An adjustable blower and worklight that keep your cut line clear of dust and well-illuminated. Toolless blade holders that accept both pin- and plain-end blades. And controls for the saw that are right up in front where you need them. If you're a hard-core cabinetmaker who occasionally needs some fretwork, we highly recommend the Dremel. And if you are a novice scrollsawyer, the Dremel 1608 has a lot of the features of the big boys (except the price) and would be an excellent choice for a first scrollsaw. **PW**



Contact Dremel at 800-437-3635 or www.dremel.com

So what if you don't sew? This authentic Shaker case piece is drop-dead gorgeous in any room.

This tailor's cabinet was brought to my attention by a customer who wanted one just like it. She had seen the piece in John Kassay's "The Book of Shaker Furniture." The original was made in Watervliet, N.Y., during the first half of the 19th century using plain and figured maple, and pine for the panels and interior pieces. The book also describes the drop-leaf on the original as being of walnut, indicating it may have been added later. My customer wasn't looking for a walnut leaf or pine sides, and I assured her I could make those changes.

This is a great storage piece for any number of rooms in the house, and while the leaf adds character, it doesn't add all that much space. While the leaf may never be used, I like the way it looks; so it's well worth the effort.

The basic construction of the cabinet is frame and loose panel for the sides and back. The front is a mortise-and-tenoned frame filled with drawers. Construction starts with the legs. Cut them to size according to the Schedule of Materials, then mark the foot of each leg for the simple tapered turning. The taper starts $4\frac{7}{8}$ " from the bottom. At the top of the taper the leg is turned from a $1\frac{5}{8}$ " square post to a $1\frac{1}{2}$ " round, then tapered to 1" at the base.

With all four legs tapered, determine the arrangement of the legs to show off the best figure and mark them to keep them straight. The sides and back of the cabinet are made of panels and rails with tenons that fit into grooves that are cut on the inside faces of the legs. The grooves are $\frac{3}{8}$ " wide x $1\frac{1}{8}$ " deep and are run $\frac{1}{4}$ " in from the outside edge of the leg. I used a router table to run the grooves, lowering the leg onto the bit to start the cut and lifting at the end of the cut. Use indexing

Shaker Tailor's Cabinet

by Glen Huey

Glen Huey builds custom furniture in his shop in Middletown, Ohio, for Malcolm L. Huey & Sons and is a contributing editor for Popular Woodworking. See his work at www.hueyfurniture.com

Photo by Al Parrish



1-G



With the tenons and mortises formed, and the legs turned, the puzzle begins to take shape by gluing up the front frame. Notice the double-tenon used in the legs for extra strength.

marks on the router table fence to indicate when to start and stop the groove. Make the same groove in the side and back rails and stiles to hold the panels in place. The groove will be off-center on the rails, so determine which face is most attractive and run the grooves with the best side on the $\frac{1}{4}$ " offset while the router table is set up.

The next step is to cut the mortises in the legs, then form the tenons on the front rails. You'll see in the photo above that the front rails have double tenons for extra strength. Mark the mortise locations on the front legs, then use a mortiser or router to cut the mortises. While using the mortiser, mark the locations for the 10 drawer runners on the inside of the face rails and cut those mortises as well. Then set your table saw to cut the double tenons on the ends of the front rails.

The front stile dividing the upper four drawers is attached to the second rail with a half-lap or bridle joint, cut exactly in the center of the rail and the stile. I made these cuts on the table saw, nibbling away with repeated passes. Assemble the front frame by starting with the stile, attaching it to the top and third rails using pegs through the rails.

Next cut the tenons on the ends of the side and back rails and back stiles. I again used the table saw to make these cuts. The tenons are centered on the pieces and offset from the center to match the grooves.

Cut rabbets on all four sides of the side and back panels. As these are $\frac{1}{2}$ "-thick pieces, a $\frac{1}{8}$ " rabbet forms the tenon easily so that the inside faces of the panels and the rails will be flush on the inside. By setting your table saw's rip fence to $\frac{3}{8}$ " (with the blade set at $\frac{1}{2}$ " high) the rabbets can be easily cut on the saw by running the



It never hurts to check the fit when so many pieces come together in one place. Check the spacing of the panels and rails into the legs and adjust as necessary.

panels on end.

To add a nice detail to the piece, put a beading bit in your router and run a $\frac{1}{4}$ " detail on both edges of the side center rail and on the inside edges of the top and bottom rails. Cut the notches for the drop leaf support in the top back rail according to the diagram, then assemble the back and rear legs. Use glue on the rail and stile tenons, but don't glue the panels so the wood can move.

Drawer Supports

While the glue is drying, turn to the drawer supports. There are four side supports and two center supports for the upper drawers, and four side supports for the lower drawers.

Cut the supports to the sizes given in the Schedule of Materials. The supports



To guide the drawers smoothly, I attach simple poplar strips with a brad nailer to the drawer supports. A little wax on the supports and the drawer runs smooth as silk.



With everything sitting in place, it's time to add the back and clamp everything down. Notice the two drawer support rails attached to the back.

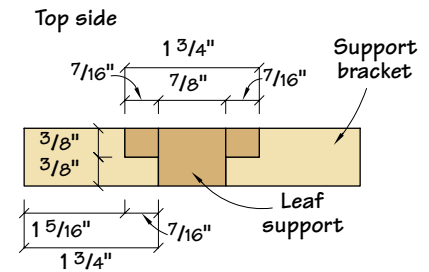

Leaf Supports & Brackets

are all a little different, but let's start with the front end. Make $\frac{3}{8}$ " x $1\frac{3}{4}$ " x $\frac{3}{8}$ "-long tenons on the front of all the side supports. Make $\frac{3}{8}$ " x 2" x $\frac{3}{8}$ "-long tenons on the front of the two center supports. Only the six top supports have tenons on the back end. Make the side support tenons $\frac{3}{8}$ " x $1\frac{3}{4}$ " x 1" long, and the two center supports $\frac{3}{8}$ " x 2" x 1" long. The four lower drawer supports are notched $\frac{3}{4}$ " x 1" around the rear leg, and then tapered on the inside edge. These are then nailed in place, with reproduction nails, to the rear leg after assembly.

To attach the upper drawer supports at the rear of the cabinet, mortise and then



The three-piece leaf supports are kind of clever if I do say so myself. By trapping the support itself between the front and back of the case, the support has a built-in stop in both the open and closed position.

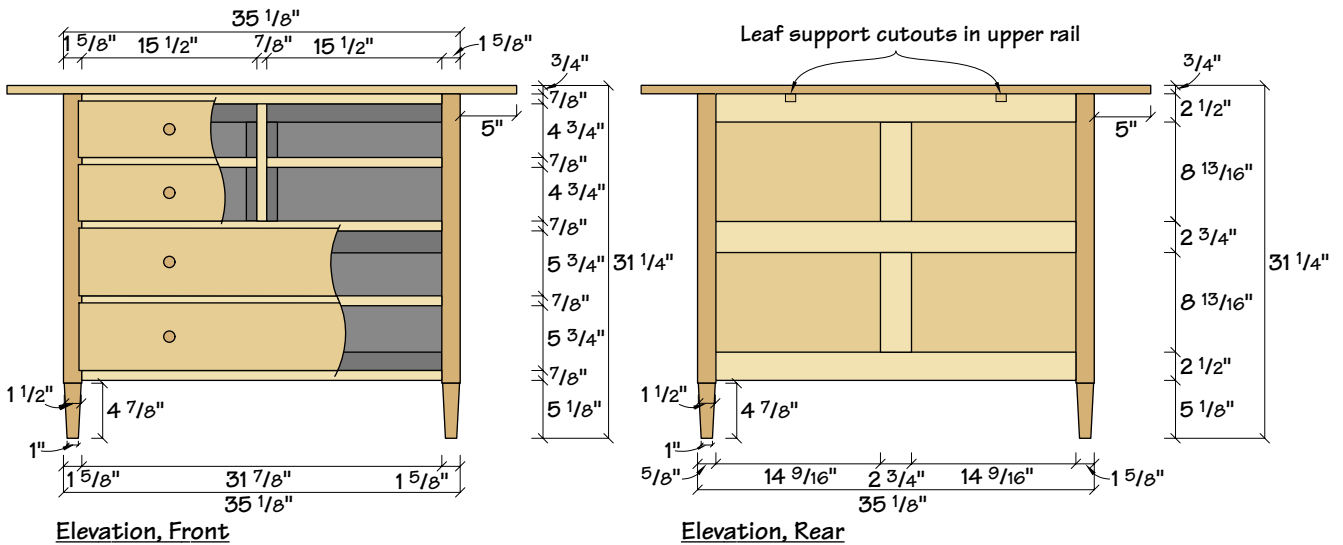
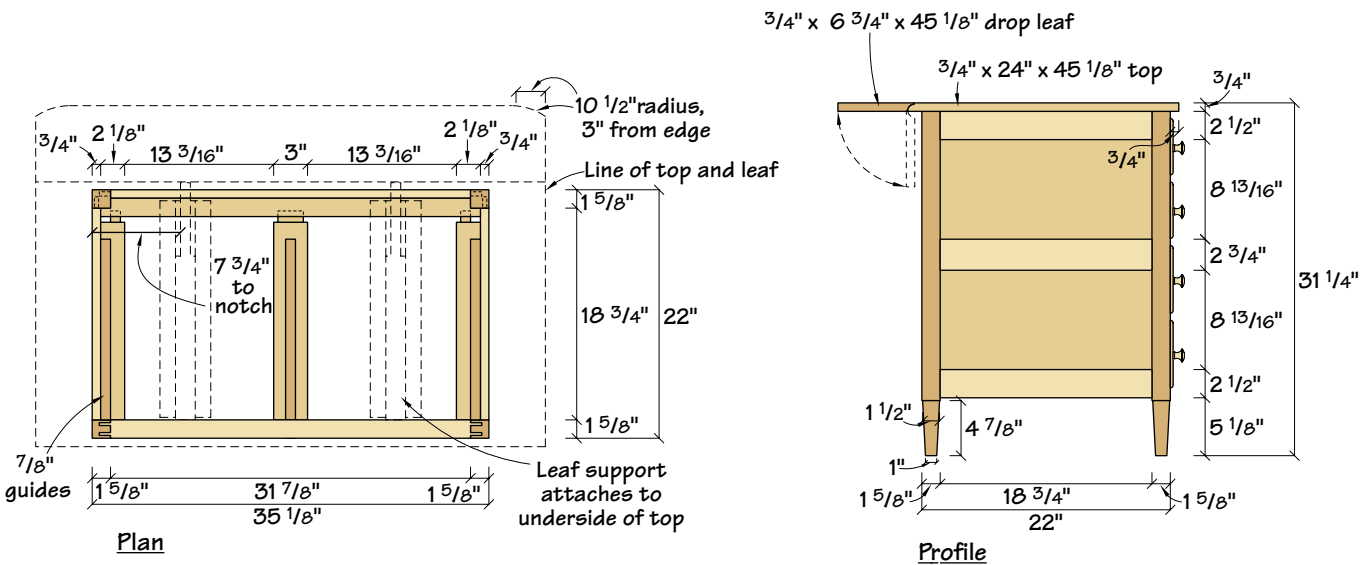

SCHEDULE OF MATERIALS: SHAKER TAILOR'S CABINET

No.	Item	Dimensions T W L	Wood	Notes*	No.	Item	Dimensions T W L	Wood	Notes*
4	Legs	1 5/8" x 1 5/8" x 30 1/2"	P		8	Drwr sides	1/2" x 4 1/2" x 19"	S	
4	Side rails, top/bott.	3/4" x 2 1/2" x 20 3/4"	P	1" TBE	4	Drwr backs	1/2" x 3 3/4" x 15 3/8"	S	
2	Side rails, middle	3/4" x 2 3/4" x 20 3/4"	P	1" TBE	4	Drwr fronts	7/8" x 5" x 16 1/8"	P	3/8" lip 3X
2	Back rails, top/bott.	3/4" x 2 1/2" x 33 7/8"	P	1" TBE	4	Drwr bottoms	5/8" x 16" x 19 1/4"	S	CTF
1	Back rail, middle	3/4" x 2 3/4" x 33 7/8"	P	1" TBE	4	Drwr sides	1/2" x 5 1/2" x 19"	S	
2	Back stiles	3/4" x 2 3/4" x 10 13/16"	P	1" TBE	2	Drwr backs	1/2" x 4 3/4" x 31 3/4"	S	
5	Front rails	7/8" x 1 5/8" x 33 7/8"	P	1" TBE	2	Drwr fronts	7/8" x 6" x 32 3/8"	P	3/8" lip 3X
1	Front stile	7/8" x 1 5/8" x 10 3/8"	P	Half-lap	2	Drwr bottoms	5/8" x 32" x 19 1/4"	S	CTF
4	End panels	1/2" x 9 3/8" x 19 3/8"	P	3/8" TAS	1	Top	3/4" x 24" x 45 1/8"	P	
4	Back panels	1/2" x 9 3/8" x 15 3/16"	P	3/8" TAS	1	Leaf	3/4" x 6 3/4" x 45 1/8"	P	
4	Drwr runners	3/4" x 2 1/8" x 18 7/8"	S	3/8" TOE	4	Support brackets	3/4" x 1 3/4" x 19 3/16"	S	
2	Drwr supports	3/4" x 1 5/8" x 33 1/8"	S		2	Leaf supports	3/4" x 1 3/4" x 21"	S	
4	Drwr runners	3/4" x 2 1/8" x 18 7/8"	S	3/8" / 1" T	10	Drawer guides	3/4" x 7/8" x 16"	S	
2	Drwr runners	3/4" x 3" x 18 7/8"	S	3/8" / 1" T					

*TBE=tenons both ends; TAS=tenons all sides; TOE=tenon one end; x/xT=size of tenon on each end; 3X=on three sides; CTF=cut to fit

MAKING A RULE JOINT

The rule joint for the top and leaf attachment requires a certain amount of accuracy, but it pays off in the end. With a little care, a test piece isn't even necessary. I used

$\frac{1}{2}$ " cove and roundover bits sold separately (CMT 888-268-2487, #838.880.11 - \$40.50 & #837.850.11 - \$38.90). You can find sets in other catalogs.

The first step is to run the roundover bit on the top piece, leaving about an $\frac{1}{8}$ " shoulder at the top.

Next, use the cove bit to run the profile on the leaf, making the cut less deep than should be necessary. Then place the two pieces together to check the fit, and adjust the depth of

the cove cut deeper until the top surfaces are flush.

Next, turn the top and leaf over and mark the locations for the hinges so that the center of the barrel is $\frac{1}{2}$ " from the lip of the top. With the location marked, use a $\frac{5}{16}$ " straight bit

to make a relief cut in the underside of the top piece that's deep enough for the barrel of the hinge to slip into. Allow for the thickness of the hinge leaf when determining the depth of the recess.

With the barrel recessed into the top, mark the hinge location on the top and leaf, and rout a recess for the hinge leaves into both pieces. The same bit used to rout in the barrel should

work for this operation as well.

When you rout for the hinge leaf recess, make the cuts short of the pencil line, then use a chisel to clean up the recess. Start the clean-up by defining the perimeter of the recess

using a chisel. Pare the material at the pencil marks. Then use the chisel held flat to remove the waste. Now simply attach the hinges, mark the length of the top and cut the top and leaf to length.

The drawers are constructed using dovetails (half-blind on the front and through at the back) and a beveled bottom slipped into grooves in the front and sides (right). A trick from our clever ancestors was to cut a slot in the back edge of the solid wood bottom and nail the bottom in place at the slot (below), with the bottom glued to the front. This allows the bottom to move with changes in humidity.



nail two support battens in place on the back legs.

You're now ready to assemble. Test fit the side panels and rails in the back legs, and check the fit of the front frame to the sides. If everything fits well, lay the face frame on your work surface and glue the side rails to the front legs (again leaving the panels glue-free) then glue the drawer supports into their mortises in the front frame. Lower the back into place, leaving the tenons on the drawer supports glue-free. Check for square and clamp the cabinet until the glue is dry.

The drawer supports provide support for the bottom of the drawers, but to get them to move well they also need some guides to control side-to-side movement. These $\frac{3}{4}$ " x $\frac{7}{8}$ "-wide strips are simply tacked in place to the drawer supports to guide the drawer sides.

While you're still working on the inside of the cabinet, cut the leaf supports and the four brackets to support them to size. Each pair of brackets is rabbeted $\frac{3}{8}$ " x $\frac{7}{16}$ " on one side, and the leaf supports are rabbeted on both sides to form a stubby "T" cross-section. Then notch the support as shown in the photo and chamfer or round the end to avoid sharp corners. Later you will screw the brackets to the underside of the top with the arm protruding through the notches you cut in the back rail.

Drawers and Details

The drawers are of standard construction (by 19th century standards, that is) with hand-cut dovetails and a solid wood bottom. Cut a $\frac{3}{8}$ " x $\frac{1}{2}$ " rabbet on three sides of the drawer fronts, then use the same beading detail as on the side rails to dress up all four edges of each drawer.

It's now time to get to the rule joint that attaches the drop-leaf to the top. First glue up the large top, leaving it oversized

for length until after the top and leaf have been attached by the hinges so the lengths will match perfectly. Use the information at left to cut the rule joint. I use standard hinges for my drop-leaf. If you purchase special drop-leaf hinges, then you won't have to rout a recess for the barrel as shown.

The top is attached to the cabinet by using rectangular wooden "buttons" that have a short tongue. The tongue slips into grooves cut in the side rails with a router and a slot cutter. If you don't feel like making your own buttons, you can purchase metal clips through most hardware catalogs. Cut the slots wide enough to allow the top room for wood movement. Attach the leaf supports to the top at this time.

After a good sanding, the cabinet is ready to finish. If you've read any of my earlier pieces in *Popular Woodworking* you may have noticed I have a favorite finish for curly maple furniture. I used that finish again on this piece. (Moser's Golden Amber Maple, a water-based aniline dye, available from Woodworker's Supply, 800-645-9292 as item #W14904 for \$10.40.) After the dye is dry, lightly sand the entire piece to remove any raised grain, then top coat the piece with lacquer or your favorite choice of protective finish. **PW**

SUPPLIES

Rockler 800-279-4441

3 brass-plated table hinges, 1 $\frac{1}{2}$ " wide and 3 $\frac{3}{16}$ " long, item # 29249, \$3.99 a pair.

Metal tabletop fasteners item# 34215, \$1.99/pack of eight



Dovet





tail

JIG

Save yourself years of practice with this incredible jig that helps you hand-cut perfect through-dovetails.

Years ago when I first learned to cut dovetails, my first joints weren't things of beauty. Sometimes there were more shims than pins. Over time, my work got better and faster. But despite the improvement in my skills, I still had trouble cutting tails or pins consistently, especially if I got out of practice.

This jig allows you to make great dovetails on your first day. The idea came to me when I was building a Shaker stepstool using hand-cut dovetails. I made a jig that fit over the end of a board to guide my saw through the cut and provide a perfect tail. The jig didn't cut pins and only worked on $\frac{3}{4}$ "-thick boards. I guess I wasn't thinking big that day.

A few weeks later it came to me: Why not build a jig that cuts both tails and pins and is adjustable to a variety of thicknesses? So I made this jig. From the first joint I cut using it, I got airtight joints. It was very cool.

This jig uses a 9-degree cutting angle. Woodworking books say that 9 degrees is intended more for soft woods than hardwoods (which use a 7-degree angle) but I thought it a good compromise. You can build this jig entirely by hand, but I cheated and used a table saw for a couple of the precise angle cuts. Let your conscience be your guide.

One of this jig's peculiarities is that you'll sometimes have to cut right on the pencil line. As designed, this jig works best with Japanese-style Ryoba saws on material from $\frac{3}{8}$ " to $\frac{3}{4}$ " thick. Use the saw's ripping teeth when making your cuts. You could modify this jig to accommodate Western saws, but you'd have to take a lot of the set out of the teeth so you didn't tear up the faces of the jig. The set of a saw's teeth basically allow you to "steer" a blade through a cut. This jig does all the steering. You just have to press the gas. **PW**

By Jim Stuard

Photos by Al Parrish



Start With a Sandwich

Begin by sandwiching three pieces of wood. This part is made from two pieces of $\frac{3}{4}$ " x 6" x 36" plywood with a piece of 1" x 1" x 36" solid wood centered between. Use a spacer to index the center precisely in the middle of the larger panels. Glue and nail the sandwich together.

1



2

Cutting the Angles

Set your saw's blade to 9 degrees and crosscut the end of the sandwich while it's flat on the saw. Next, tilt the blade back to square and set the miter gauge to 9 degrees as shown (above). You can use the angled end of the sandwich to set your miter gauge. Lay out a center line down the middle of the sandwich and mark from the end of the line about $3\frac{1}{2}$ ". Use a sliding t-bevel to transfer the angle to the flat side. This yields a jig that will let you cut dovetails in material as narrow as 3" wide. Any narrower and you'll have to shorten the jig. Lay the extrusion flat on the saw table and cut to the line. The jig will be a little narrower on the other side but that's OK.

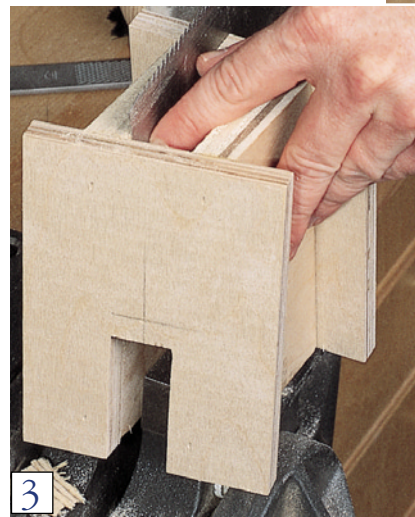

3

Remove the Waste

Attach the $\frac{1}{2}$ " x $4\frac{1}{4}$ " x 6" faces to the ends of the jig with nails and glue. Use a Ryoba saw to start the cuts to open up the channels in the jig (above and right). Use a coping saw to cut out the part of the ends that cover the little channels in the sandwich (far right). Note the blade is perpendicular to prevent binding on the jig itself. Clean up with a rasp and sandpaper.

4



7

Add an Abrasive

Using contact cement, attach 120-grit sandpaper to the same side of the inside channel, on both sides of the jig.

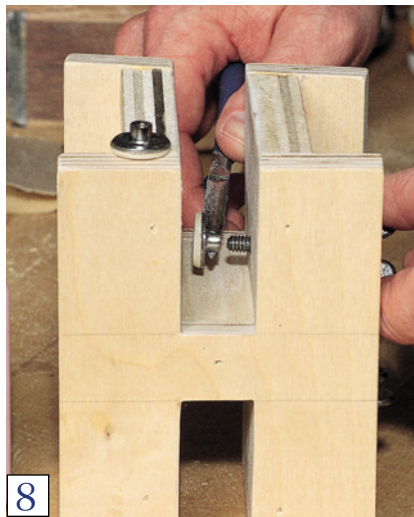

8

Quick Clamping

Doctor up a couple of $\frac{1}{4}$ "-#20 T-nuts by pounding over the set tines and grinding off a little of the threaded barrels. With some two-part epoxy, attach some $\frac{1}{8}$ "-thick wooden pads to the face of the T-nuts. When the epoxy is set, sand the pads to fit the T-nuts. Run your thumbscrews through the threaded inserts and attach the T-nut/pads to the thumbscrews with some thread-locking compound (available at any automotive parts store). Finish the jig by attaching something slick to the faces. I used some UHMW (Ultra High Molecular Weight) plastic self-stick sheeting. It's $\frac{1}{16}$ " thick, and if you wear out the material on a face, you just peel off the old material and stick on some new. You could just as easily use some wax on the wood faces. You'll just have to sand them flat, eventually.



9

Cutting Tails and Pins

Using the jig couldn't be simpler. I cut tails first. That's a personal choice, but this jig will work well whether you're cutting tails or pins first. The layout is a little simpler than when going "free-hand." All you do is mark the depth of the cut with a marking/cutting gauge and lay out the spacing for the tails on the end of the board. Use the pencil marks to cut out the tails (above) and when you get the waste cleaned out, use the tail end of the board to lay out the pins (right). Use a sharp pencil for marking, then cut out the pins. Check the fit of the pins to the tails using a piece of scrap as a hammer block across the whole joint. If they're a little big, do some fitting with a four-in-hand rasp. The joint should be snug, but not so tight that it cracks the tail board when hammering the joint together.

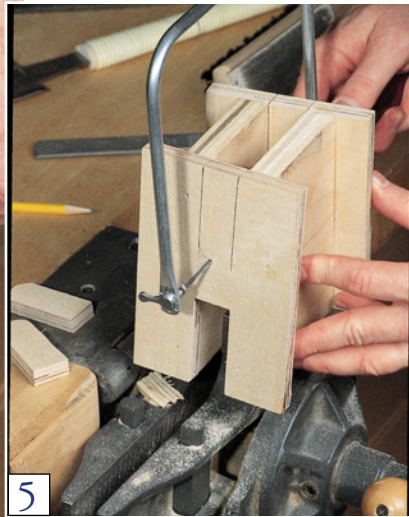

Threaded Inserts

Lay out and drill $\frac{5}{16}$ " holes as shown in the diagram. These accommodate the threaded inserts for the set screws. Attach the threaded inserts using a hex key/Allen wrench.

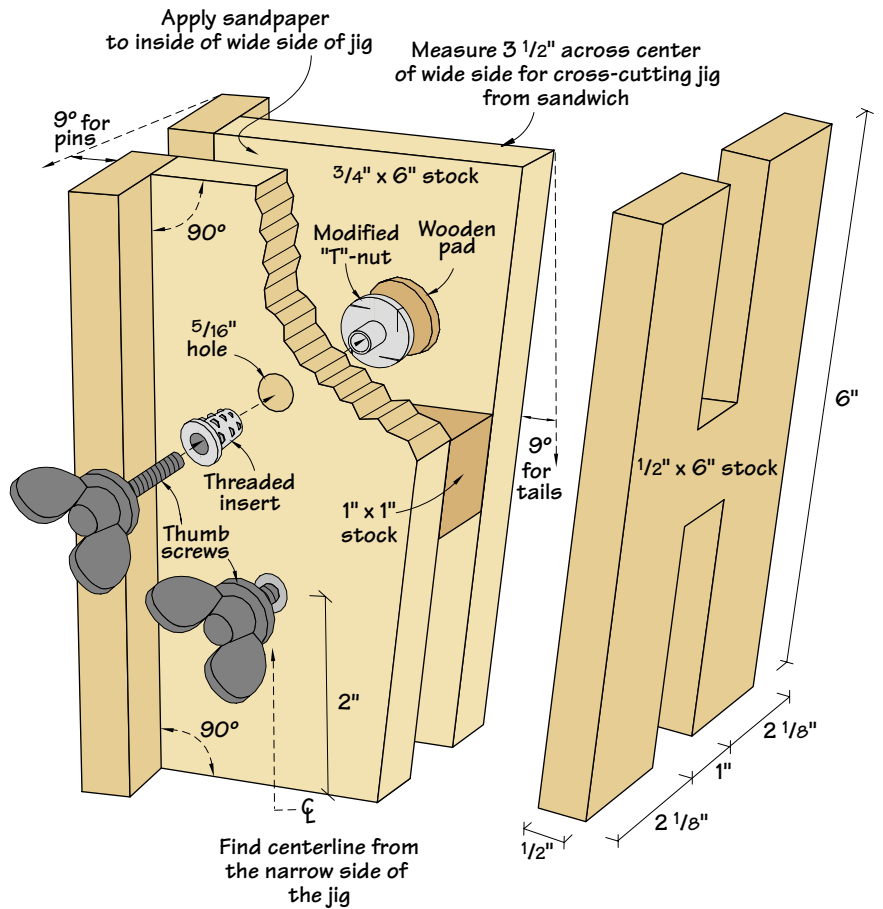

SUPPLIES

Lee Valley
800-871-8158
2 • $\frac{1}{4}$ "-20 flanged insert nuts # 00N10.13, \$.09 each.

Ried Supply
800-253-0421
2 • $\frac{1}{4}$ "-20 thumbscrews #MIT88, \$1.99 each.

Woodcraft
800-225-1153
3"-wide UHMW self-stick tape #16L65, \$17.99/roll

SCHEDULE OF MATERIALS: DOVETAIL JIG

No.	Item	Dimensions T W L	Material
2	Sides	$\frac{3}{4}$ " x 6" x 36"	Plywood
1	Center block	1" x 1" x 36"	Poplar
2	Faces	$\frac{1}{2}$ " x $4\frac{1}{4}$ " x 6"	Plywood

Much like a
skyscraper,
this tower manages
to pack tons of
office stuff into
a tiny footprint.

modern storage tower



The last thing I want to do when starting work at my computer is to clear out a place to work. Unfortunately, some years ago my piles of stuff overpowered what little storage space I had. And all that junk sitting around has a tendency to make a spouse go ballistic.

Enter this modern storage tower. It will tame almost any wild pile of junk, and yet it takes up less than 2 square feet of floor space. The open shelves are designed to hold magazine storage boxes you can buy at an office supply store. The CD drawer holds 38 CDs — that's not enough space for a music collection, but it should handle an average collection of computer CD-ROMs. And the see-through doors let you display stuff or protect a few books.

I built this project using the Little Shop That Could Mark II, a rolling workshop on wheels that contains only \$1,000 in tools. It was featured in the September 1999 issue of *Popular Woodworking*. And though we're sold out of that issue, you can see the plans for this rolling shop on our website (www.popularwoodworking.com) or you can pick up a copy of the new book "25 Essential Projects for Your Workshop" (Popular Woodworking Books) that features complete plans for the Little Shop.

This tower project is great for the beginner because it gives you a chance to try out some simple techniques you won't learn anywhere else. You'll learn to make

by Jim Stuard

Photos by Al Parrish





Cutting Down Panels

The Little Shop Mark II is a great system for cutting up large panels. Simply crosscut the 4 x 8 sheet to a little over the finished length and then rip the panels from the shorter piece

First cut rabbets in the side, bottom and top pieces that will hold the back as shown in the photo at left. Then cut rabbets in the sides to hold the bottom in place (the top is attached later). Lay out the locations for the biscuit joints for the fixed shelves. First clamp the two sides and partition pieces together side-by-side and make sure the top and bottom are perfectly aligned. Use a piece of plywood as a fence as shown in the photo at right to hold the biscuit joiner in place as you make your cuts. I used three #20 biscuits at each location where a shelf met a side piece. Note, because the partition is biscuitted on two sides, you'll have to flip it over after cutting biscuit slots on one side.



Rabbets on the Back

After cutting the panels to length, cut $\frac{1}{4}'' \times \frac{1}{2}''$ rabbets in the back edges of the sides, top and bottom to hold the back piece. Finish the rabbeting by cutting a $\frac{1}{2}'' \times \frac{3}{4}''$ rabbet in the bottom ends of the sides for the bottom. When cutting rabbets this way, watch out for the falloff flying back at you.

When all the biscuit slots are cut, dry-assemble the case to find any problems that might occur during assembly. Make sure the bottom sits squarely in its rabbets and check the top to ensure it touches the two sides and partition evenly.

If everything is OK, glue and clamp the case together. Clamp up the case with it face down on your work surface. This ensures the partitions and sides are all flush at the front. Check the case to see if it's square by measuring it from corner to corner.

“veneer strips” to cover plywood edges then glue them on using an electric iron. This is real simple and cheap, too. You'll also learn how to cut splines for miters and clamp your miters using a quick shop-made band clamp made from scraps and an ordinary rope.

Get it Down to Size

Begin construction by cutting out your

parts according to the Schedule of Materials. If you can rip and crosscut the plywood on your table saw, great (the Little Shop excels at this function). However, you can also use a circular saw or jigsaw to get the pieces down to manageable sizes and then finish them up on the table saw. Either way, cut your pieces a little bigger than the stated sizes so you can then trim off the rough factory edges.

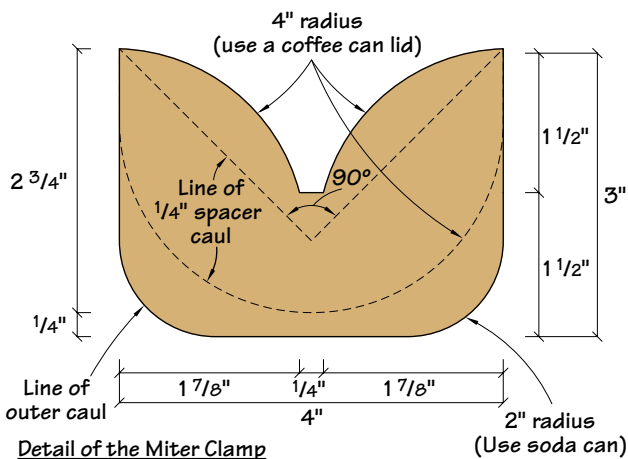

SCHEDULE OF MATERIALS: MODERN STORAGE TOWER

No.	Item	Dimensions T W L	Material
2	Sides	$\frac{3}{4}'' \times 13\frac{1}{4}'' \times 55''$	Plywood
1	Bottom	$\frac{3}{4}'' \times 13\frac{1}{4}'' \times 15\frac{3}{4}''$	Plywood
1	Partition	$\frac{3}{4}'' \times 13'' \times 54\frac{1}{4}''$	Plywood
6	Shelves	$\frac{3}{4}'' \times 13'' \times 7''$	Plywood
1	Back	$\frac{1}{4}'' \times 15\frac{3}{4}'' \times 55\frac{1}{4}''$	Plywood
1	Top	$\frac{3}{4}'' \times 13\frac{1}{4}'' \times 16\frac{1}{4}''$	Plywood
1	Top front edge	$\frac{3}{4}'' \times 1\frac{1}{2}'' \times 19\frac{1}{4}''$	Maple
2	Top side edges	$\frac{3}{4}'' \times 1\frac{1}{2}'' \times 14\frac{3}{4}''$	Maple
8	Feet	$\frac{3}{4}'' \times 2\frac{1}{2}'' \times 4''$	Maple
8	Feet brackets	$\frac{3}{4}'' \times 1\frac{3}{4}'' \times 1\frac{3}{4}''$	Maple
4	Door stiles	$\frac{3}{4}'' \times 1'' \times 13''$	Maple
4	Door rails	$\frac{3}{4}'' \times 1'' \times 7''$	Maple
1	Drawer front*	$\frac{3}{4}'' \times 6\frac{7}{8}'' \times 12\frac{7}{8}''$	Plywood
1	Box side	$\frac{1}{4}'' \times 12'' \times 11\frac{3}{4}''$	Plywood
2	Box top & bottom	$\frac{1}{4}'' \times 6\frac{1}{2}'' \times 11\frac{3}{4}''$	Plywood
2	Box back & divider	$\frac{1}{2}'' \times 6\frac{1}{4}'' \times 12''$	Plywood

*Cutting size before applying edging. Some fitting is necessary.

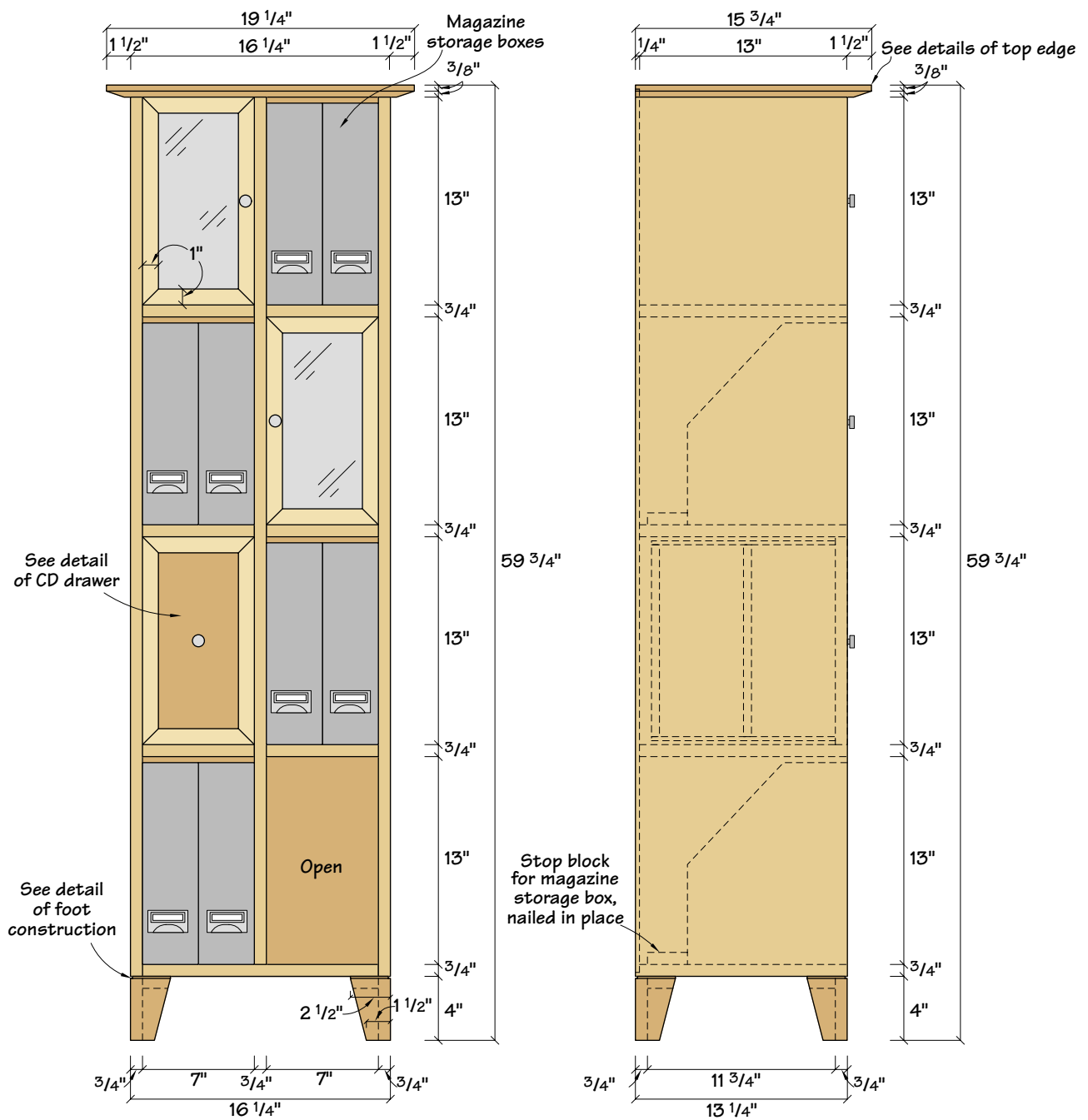

Biscuit the Panel

Clamp a straightedge to the marked line indicating the bottom of the shelf. Place the joiner up against the straightedge to make the cut. Cut slots in the shelves by placing them on a flat surface and repeating the process, indexing the joiner and shelf on the same surface.



Spline-Cutting Jig

Use a two-piece jig shown above. Hold the door parts at 45 degrees and gently push them through the saw blade, leaving a saw cut 1/2" deep.

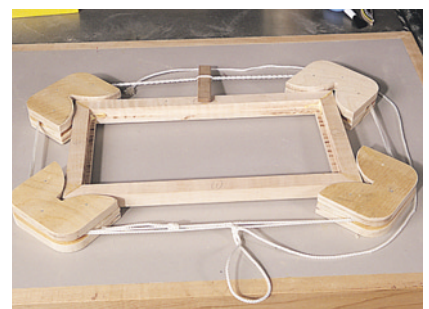

Clamping the Doors

When you have a door glued together, place cauls on each corner. The groove in the back will evenly distribute the pressure from the rope on the joint. The curved indexing surface ensures that the clamp always provides pressure at the same point on the joint.

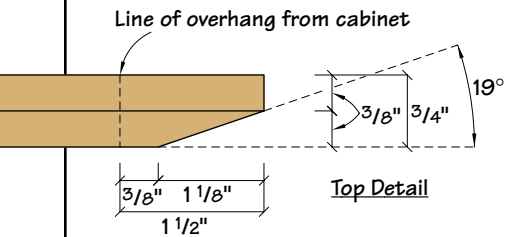

Mitered Door Frames

While the glue is drying, cut out the parts for the doors. They are made by mitering $\frac{3}{4}$ x 1" strips of wood that have a $\frac{1}{4}$ x $\frac{1}{2}$ " rabbet cut on the back edge for glass or Plexiglas.

If you don't have a miter sled to cut the rails and stiles for the doors, screw a sacrificial fence to your miter gauge. Clamp stops to the fence for the different length parts. After the door parts are cut to size, it's time to cut the slots for the splines that will reinforce the joints. First cut some spline stock from some scrap maple that's as thick as the kerf made by your table saw blade. It helps to cut it a little thick and sand or plane it to thickness. Remember to have the spline's long grain run across the joint in the door. This provides the strongest joint possible.

Cut the slots for the splines using your table saw as shown in the photo on the previous page.

The next step is to glue the doors together. To do this in one step you need to make small tulip-shaped clamping cauls as shown in the diagram. These cauls push



Homemade Veneer Tape

To apply the veneer, simply lay down a bead of woodworking glue. Spread it out with a brush or a handy finger. Lay the veneer on the edge and apply high heat (not the baseball kind) to the edge with a common clothes iron. When you see the glue start to bubble out of the joint, the veneer is almost set. Leave it on a little longer and apply pressure with a roller. A screwdriver shaft works in a pinch.

the miters together no matter where the clamping pressure comes from. The other neat thing about these cauls is that you use a length of rope to provide the pressure. Simply twist a small stick into the rope like you would on a bow saw, and turn it until you get as much or as little pressure as you want. After the glue is dry, remove the clamps and clean up the doors with a chisel and plane.

Covering the Edges

When you're done with the doors, go ahead and add some solid wood edging to the top piece. Cut the $\frac{3}{4}$ x $1\frac{1}{2}$ " edging for the

top, miter the edging and attach it to the top piece with biscuits. Now cut the chamfer on the front and sides as shown in the diagram.

By now the case is ready for the edging. Cut the edging from $\frac{1}{32}$ "-thick stock in $\frac{1}{32}$ "-thick strips. Rip this edging from a wider piece of wood. To be on the safe side, rip the edging on the outside edge of the blade — don't set your fence for $\frac{1}{32}$ " and cut it that way. You apply this edging the same way you apply commercial iron-on edging: using adhesive and heat. The only difference is you supply the yellow glue and the edging as shown in the photo. Glue the long edges to the case first. Clean them up with a chisel and file. Cut the edging for the shelves and apply them next.

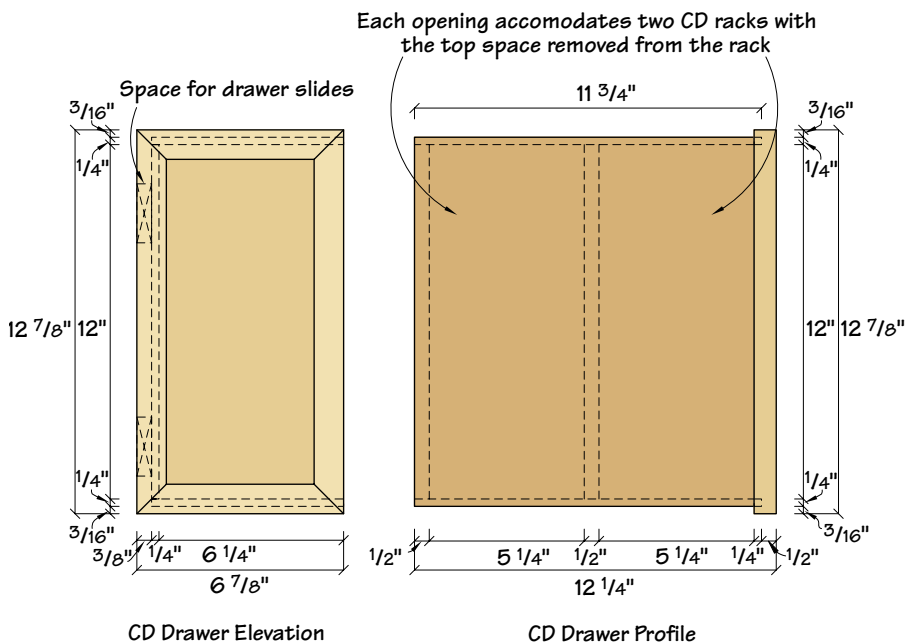

HANGING A DOOR USING LOOSE PIN HINGES

- 1) Lay out and cut the mortises for the hinges.
- 2) Separate the top hinge and attach half to the case mortise and half to the door.
- 3) Hang the door by the top hinge and use this location to index the bottom hinge placement.
- 4) Screw the bottom hinge in place and you're done. This method makes sure the hinges won't bind while hanging the door.

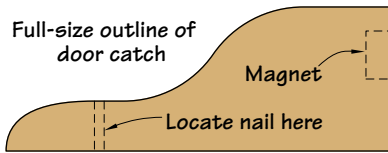

Door Catch

Details

Screw the top in place, plug the holes and cut the plugs flush. Now fit the doors in their openings. The object is to have a $\frac{1}{16}$ " gap all the way around. Hang the doors using loose pin hinges (these will make the doors easier to install). One problem these hinges cause with a small gap is that one edge can bind against the partition. You can remedy this by planing or sanding a little radius on that inside edge to make the door swing freely. Install the pulls and make a couple of shop-made stops with rare-earth magnets. Nail and glue the stops behind the screw heads on the door pulls and use them to hold the door closed.

Make the feet from a glued-up "L"-shaped piece of solid wood. Rip a 45-degree bevel on two pieces of $\frac{3}{4}$ " x $2\frac{1}{2}$ " x 25" maple. Biscuit them together and glue them up using the rope and cauls you used on the doors. It's possible to use one long piece of rope to do the entire glue-up. Just keep knotting the rope strategically and re-wrapping it around the next caul. Cut the feet to length and cut a $\frac{1}{8}$ " x $\frac{1}{8}$ " rabbet in the top outside edge of each foot. Cut the tapered profile shown in the diagram. Glue and nail a corner block to the inside corner of each foot. This block al-

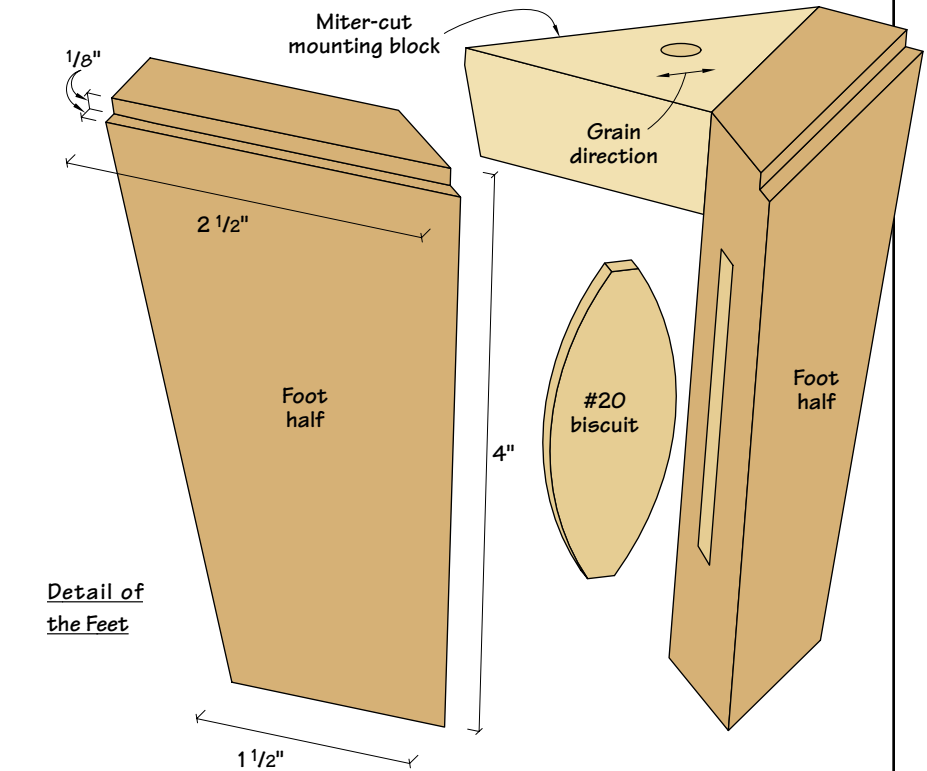

lows you to screw the foot to the bottom of the case. Glue and screw the foot flush to the case corners.

CD Drawer and Finish

The last casework to do is make the CD storage drawer. It's basically a small plywood box that accommodates plastic CD racks that screw into the box sides. Make a note that you have to cut these plastic rails down one space to fit the design of the tower.

Make the drawer front first. Simply take the front piece and cut a $1" \times \frac{1}{32}"$ rabbet

on the front of the door. Apply veneer to the small rabbet, simulating the outline of a door with a solid panel and apply iron on edging to the top and side edges. The front requires stopped grooves be routed in its back side. Do this using a router in a router table. Build the box according to the diagram and hang it in the case using $\frac{1}{2}"$ drawer slides on only one side of the box. This opens up the other side for the CD racks. Screw them in place and make sure a CD fits OK.

Sand the entire unit. Apply three coats of clear finish. Finish the back separately and install it when you're done. This makes finishing easier.

When the finishing is done, it's time to "glaze" the doors using silicone. For this project, it was just as easy to use Plexiglas. Re-hang the doors when the silicone is dry and you're ready to clear off that computer desk to get the day's work done. **PW**



Glazing the Doors

Place the doors (back side up) onto a flat surface. Lay a small bead of clear silicone into the rabbet. The stuff I used comes out white so you can see it, but it dries clear. Cut the pieces to size and lay them into the rabbet on the back side of the door. Place a small piece of plywood on the plexi to protect it and place a weight on the plywood to apply pressure to the plexi while it sets. I used a couple of wood-working planes for this. When the caulk is dry, apply a bead to the other side of the plexi, sealing it into the door.

SUPPLIES

Lee Valley
800-871-8158
3 • Drawer pulls 01W13.01, \$1.10 apiece. 1 pair 12" Drawer slides 12K36.12, \$10.25/pair. 2 pair. CD rails 00S50.01, \$3.95/pair.

Introduction to

Hand

When I was first revving up my new woodworking hobby I bought a table saw and ran a 100-amp electrical service out to my shop. After all, I planned to build a table for my wife and assumed I would need a planer, a band saw, a drill press, a jointer, a router and a dust collection system to go with my bright new table saw. Then I got sick. At least that's what some would say. Actually I just stumbled onto my first old hand plane and haven't bought a power tool since. Despite my illness, my wife has her table along with a few chairs and accessories that have since come from my hand-tool-only shop. Oh, I still use the 100-amp service — that's where my coffeemaker is plugged into.

Now I know I'm in the minority when it comes to using hand tools exclusively. Not many folks will use only hand planes to thickness plane rough stock. It's my choice and I stick with it because I like it, and therapy sessions to get over it are too expensive. Still, there are a lot of uses for hand tools even in a powered-up shop.

Of all hand tools, planes are probably the most symbolic and recognizable. Planes come in so many varieties that entire books have been written just about them. Let's look at some basic hand planes that can get a budding hand tool enthusiast started or fit nicely into the arsenal of a power woodworker.

The Stanley Rule and Level Co. dominated the hand plane industry in the 19th century. Consequently, Stanley's competitors adopted its hand plane numbering system. Even today, ordinary garden-variety bench planes carry these traditional numbers to designate their size. Stanley #1 through #8 include the most basic of

by Dale Lucas

Dale Lucas is a manager of product development for an internet development company in Cedar Rapids, Iowa. While his profession is high-tech, his passion is for low-tech hand tools and the old ways of working wood.

Photos by Al Parrish

Planes



**If you don't know
jack about jack planes,
or are a blockhead when it comes
to block planes, get a quick-and-dirty lesson
about which hand planes should be in your shop.**

Lie-Nielsen's low-angle jack plane is based on the old Stanley #62 and excels at smoothing difficult woods such as curly maple. If you work with a lot of figured woods, this plane will save your bacon on occasion even if you have a whole shop of power tools.

Common Types of **Hand Planes**

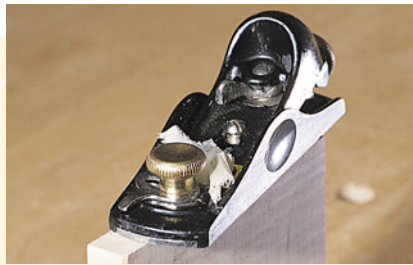

LOW-ANGLE BLOCK PLANE

This essential little plane is great for leveling joints after your glue is dry. Thanks to its adjustable throat and the fact that the iron is set at a low angle, this block plane can also tackle tricky trimming chores, such as planing figured woods or end grain.



RABBET PLANE

Whether you're cutting a rabbet from scratch, or you just need to clean up a less-than-perfect attempt, this tool is sometimes the only one that can do the job.



The plane numbering system can be confusing. For Stanley's Bailey-style planes (shown at left) the company used a system where #1 was the smallest and #8 was the largest. Shown here are some #3s on the right, a few #5s in the middle and a #7 on the left.

bench planes as well as some not so basic. In simple terms, the bigger the number, the bigger the plane. These all-metal Bailey-style planes are essentially the same form but on a different scale. And all have pretty much the same function: to make the wood flatter and smoother than it is. The smaller ones are better for small work while the larger ones are best for leveling out the large boards. See how simple hand tools are? I don't own one of each of these sizes, nor do I need to. There is not much size difference from one number to the next, though there is a lot of difference between a #1 and a #8, and understanding these differences will make using hand planes more of a pleasure than a pain.

If you ever come across a Stanley #1, type 1, and it costs less than your house payment, buy it. These little gems aren't much for actually cutting wood (you could pull it out of your shop apron to trim a joint), but they'll cut plenty deep into your wallet.

Numbers 2 through 4 are smoothing planes from 7" to 9³/₄" inches long. While not as small or pricey as the #1, the #2 is

still on the smallish side and is not usually available from modern plane manufacturers today. That makes it more of a collectible than a good working tool. The old #3s from Stanley are 8" long, while the ones Stanley makes today list at 9". I have an old Trustworthy-brand plane that I rescued from a garage sale and restored. It's 9¹/₂" long, about the size of a #4. I use it

when I'm flattening boards from their original rough sawn, air-dried state. It helps me get at some of the high spots that my longer planes sometimes ride over. I have some 12"-14" wide air-dried pine boards that I use to make reproduction furniture. My Trustworthy/ Stanley #4 look-alike is good for this task. It's also good for jointing the edge of shorter boards.

The #5 jack plane is right in the middle of the normal range of bench planes and, as you might expect, it is the most versatile. It's 14" and has a good heft to it. That length makes it work well for jointing short boards. I have a couple of Stanley "transitional" jack planes about this size, a #26 and a #127 (these fall outside that numbering system from #1 to #8). "Transitional" planes have a wood bottom and metal upper structure. This type of plane was common at the end of the 19th century into the start of the 20th as planes "transitioned" from all wood to all metal, thus their name. I use mine for leveling

ESSENTIAL PLANES FOR THE POWERED SHOP

Plane	Uses
Low-angle block plane	Trimming high spots and leveling joints. The low cutting angle of this plane allows it to trim end grain.
Rabbet plane	Most rabbet planes are based on the Stanley #78 and excel at cleaning up rabbets. You can also trim tenons with this plane, though you'll have to clamp your work to your bench.
Shoulder plane	Shoulder planes quickly trim tenons down a hair so they fit just right. Much like a rabbet plane, these planes are great because the blade runs the full width of the plane's body. However, they are designed to be used easily with one hand.
#4 or #5 jack plane	These mid-sized all-purpose planes are useful for trimming inset doors to fit their openings or for trimming drawers so they slide smoothly.



SHOULDER PLANE

Even if you machine your tenons to exact tolerances, you're occasionally going to get one that is oversized (wood is cantankerous that way). Instead of setting up your table saw or router to trim the tenon, get out your shoulder plane and do the job in five seconds.



#5 JACK PLANE

Jack planes are good for lots of things, including trimming doors and drawers. One well-tuned tool can actually surpass the work of a jointer or a sander.

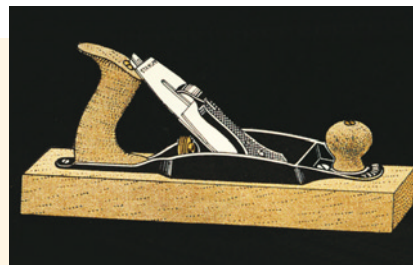

#26 PLANE

This #26 transitional plane is a common sight at antique markets. Some people prefer transitional planes because the blades are easy to adjust yet the plane is lighter than an all-metal plane.

across the wide boards that I flatten by hand and for jointing the edges of boards that are too small to support my larger jointer plane. In a power shop, these are just as useful for trimming drawers and edge jointing as well.

The #7 and #8 jointers are, as you might guess, best suited for edge jointing a board. Since they are 22"-24" long, they obviously find their use on long boards. The length of the plane causes it to ride the high spots as the blade nicks them off. That way, the high spots get lower and lower until there is nothing left but an even surface that matches the long flat bottom of the plane. I honestly can't think of a use for these in a fully powered shop if you joint all your boards with a power jointer.

Other Planes

From 1905 to 1942, Stanley made the 14", #62 low angle jack plane that is being reproduced today by plane maker Lie-Nielsen. The low angle of the blade makes it ideal for working on end grain or cross-grained wood. As I confessed before, I use a lot of pine and my Lie-Nielsen low angle jack reminds me every time I use it why I like good quality hand tools. The $\frac{3}{16}$ "-thick low-angled blade and the well-built heft of this plane makes light work of some of the most temperamental grain and hard knots that I run into. It also has an adjustable mouth that I can set to a barely perceptible opening and eliminate nearly all tear out — even in the most irregularly grained wood. This is a real plus for both the powered and the powerless shop. In fact, this beauty can sometimes tackle a job that would make most jointers and planers tremble with fear.

One other plane gem that has become

essential in my shop is the scrub plane. Scrub planes take a lot of wood off in a hurry. With my Stanley #40 I can take off a $\frac{1}{4}$ " or more from the uneven side of a 12" x 5-foot board in a matter of minutes. This is a small plane but a beast when it comes to getting my rough stock down to size. Often with hand tools, using the right one begets speed, and that's certainly the case with the scrub plane.

Rabbit and shoulder planes come in a variety of shapes and styles but all serve the same basic purpose. As implied by the name, they're used for cleaning up rabbets or any joints that have right-angled surfaces, such as the shoulders of a tenon. When you cut your mortise-and-tenon joints by hand, your hand sometimes over-cuts or under-cuts. A small side rabbit plane helps clean these up. Though I don't personally use a power tenoning jig, I hear that once in a while a little trimming or cleanup is needed there as well. That's when these come in handy for getting that just-right fit. The same holds true for dados and grooves, whether power cut or hand crafted. Some examples of these that are still made today and available through mail order and retail woodworking stores are the Stanley #78 duplex rabbit plane, the Stanley #79 side rabbit plane and the Lie-Nielsen #98/#99 set of side rabbit planes.

One final basic hand plane that I reach for often is the block plane. You can find these, old and new, in many price and quality ranges. The one I use most often is a simple Stanley #60 $\frac{1}{2}$ that I bought new from a mail order catalog. Like most modern hand tools it's not up to the heft and quality of its ancestors but it'll do for most chores. When it's freshly sharpened, it will

take clean shavings from the end grain of a freshly hand-sawn board. It's also good for softening the edges on finished work, especially if you want to have the subtle character of hand tooling instead of the uniform edges that come from a machine.

In my hand-tool-only shop I can't get along without these icons of the hand tool world. But I hear from some of my powered up brethren that these planes enhance the workmanship and pleasure of their shop as well. Even if you haven't fallen prey to the hand tool fever that struck me, you just might find that some of the rich old tradition in these tools can add to your shop as well. **PW**



You may never turn away from your 8" jointer to prepare an edge for gluing, but once you get your hands on a few well-tuned planes I think you'll see how useful they can be in any shop.



Dress up
your
kitchen
or your door
with this
scrollsawn
gem.

'Welcome Friends' Plate

This simple scrollsawn collector's plate will charm visitors to your home, and the design is simple enough that you can make a few of them in a weekend. The plate consists of two pieces that are sawn and then glued on top of one another to create the 3D effect.

Choose two contrasting woods for the different layers. I used $\frac{1}{4}$ " mahogany for the top layer and $\frac{1}{4}$ " birch for the bottom

layer, though any tight-grained hardwood will do. After you've picked out your wood, sand it to 220 grit. Make two copies of the drawing at right. Cut one pattern for the interior plate design and one for the rim design. Attach them to your wood with rubber cement or a spray adhesive.

Use a small drill bit to bore access holes for all your inside cuts, then make your cuts with your scroll saw. Clean up any

rough edges with sandpaper. Glue the two pieces together using the registration marks on the drawing and finish your plate with two coats of a clear finish.

You can hang your plate on the wall or purchase a plate holder to display it on a mantle or a sideboard. Order a wooden plate holder (not the one shown above) for \$1.95 plus shipping by calling the Berry Basket and asking for item# P550. **PW**

by Rick Longabaugh

If you like this plan, you can find many others like it by contacting Rick Longabaugh's company, The Berry Basket, at 800-206-9009 or at www.berrybasket.com.

Rim Design

Stock: $\frac{1}{8}$ " - $\frac{1}{4}$ "

Welcome

Interior Plate Design

Stock: $\frac{1}{4}$ " - $\frac{3}{8}$ "

Dashed line
indicates
position of
Interior Plate
Design on
back of Rim

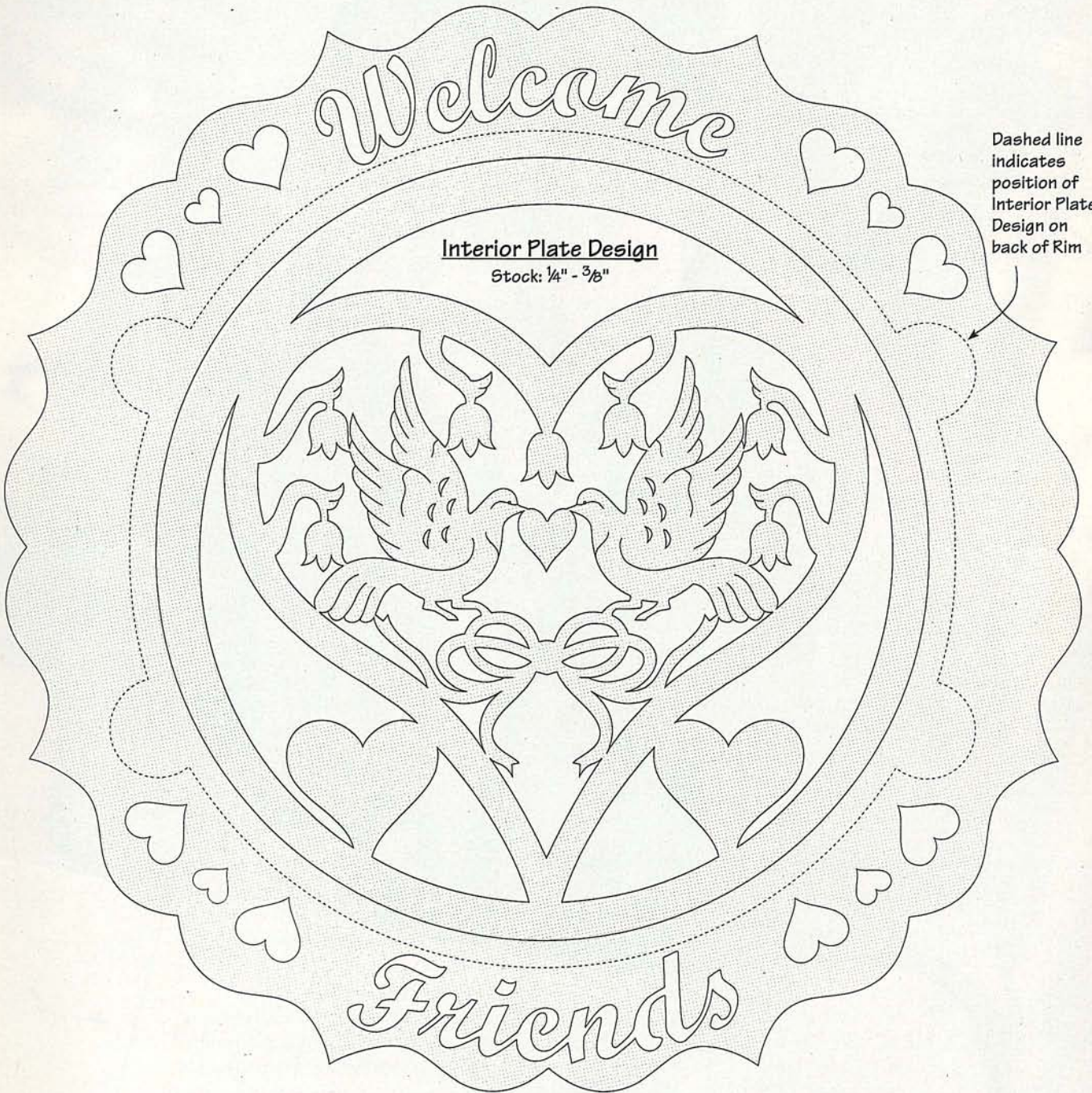



Miters

COMPOUND

FOR DUMMIES

A new angle on a classic technique.

Well, this is embarrassing, I thought to myself. Steve, Tricia and Al — a large part of the *Pop Wood* team — had made a pilgrimage to my shop to take photos of an expert craftsman making flawless compound miter cuts. And I couldn't remember how to do it.

"Wait just a minute," I told them. "I've got a book right here that tells what to do." I reached for a copy of "Nick Engler's Woodworking Wisdom" and read my own instructions on the technique.

Making compound miters — a miter joint that is both angled and beveled — is one of those special techniques that most woodworkers need only once in a great while. It's a neat trick with intriguing results. When you join the frame members, the boards have a slope so the assembled shape tapers from one edge to the other. You can employ compound miters to make picture frames, bowls, pedestals and dozens of other projects such as the Two Tub Tables on the following pages. Trouble is, it's not a technique you're likely to use every day, or even every month. In between the times when you need it, you're likely to forget some of the finer points — I know I do. So I'm going to write this article as a "refresher course" in compound mitering, as much for myself as all of you.

Figuring the Angles

When cutting a compound miter on a table saw, you must set both the miter angle of the miter gauge and the bevel angle of the saw blade. These angles depend on two things — the number of sides in your frame and the slope of the assembled frame. The slope, by the way, is usually measured from horizontal, with the frame resting on a flat surface.

For every frame and slope, there is just one pair of angles, and these angles must be precise or the miter joints will gap.

To find these angles, woodworkers of yore went through a convoluted drafting process that takes two days just to explain. Contemporary craftsmen either use some simple equations or they refer to a compound miter chart. I prefer the chart method myself, so I've included one with this article that lists angle pairs for lots of frame assemblies and slopes. But just in case you don't see the angle settings you need for your particular project, here are the equations:

by Nick Engler

Nick Engler is the author of over 50 books on woodworking, plus countless articles and project plans. He is not easily embarrassed.



To check your setup, cut enough small pieces to make a complete frame. Clamp a stop to the miter gauge extension so each piece is identical.

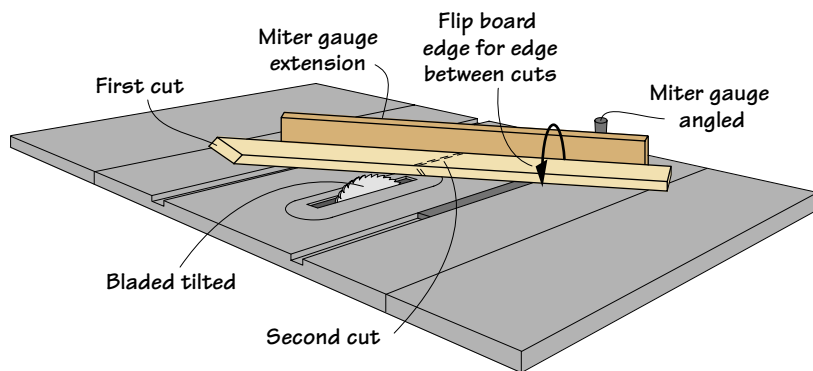

Here's the compound miter technique in a nutshell. Angle the miter gauge, tilt the blade, make your first cut, flip the board edge for edge, and make the second cut. You'd think I could remember that.

Miter Angle (for all joints):

$$\tan MA = 1 \div [\cos S \times \tan(360 \div 2N)]$$

Bevel Angle (for mitered joints):

$$\tan BA = \cos MA \times \tan S$$

Bevel Angle (for butted joints):

$$\tan BA = \cos MA \div \tan S$$

Where: MA is the miter angle; BA is the blade angle; S is the slope; N is the number of sides.

If you're mathematically challenged, don't despair at the mention of tangents and cosines. I too slept through high school trigonometry. But I still work a trig equation now and then by pounding on a scientific calculator. These have special buttons marked sin, cos and tan to simplify the functions — trigonometry for dummies.

For example, if you want to figure the miter angle for a four-sided mitered frame with a 30-degree slope, find the cosine of the slope by entering 30 on the keypad and then pushing the cos button. The result should be 0.8660 and change. Next, multiply the number of sides (4) by 2 and divide the result (8) into 360 — the result is 45. Find the tangent of 45 — that's right, just push the tan button on the calculator. Multiply the result (1) times 0.8660, then divide that number (0.8660) into 1. The answer is 1.1547 — that's the tangent of the miter angle. To convert this tangent into an angle, press the INV (or "inverse") calculator button, then the tan button. Your miter angle is 49.1074 degrees.

Always figure the miter angle first, then the bevel angle. You need the cosine of the miter angle to calculate the bevel. Note that the bevel angle equation is slightly different depending on whether you want to make the joint mitered (with the seam at the corner) or butted (with the seam

visible on one side).

On the chart, I've rounded the angles to two decimal places. There probably isn't a table saw on the planet that can measure hundredths of a degree, let alone the eight decimal places you're likely to get from your calculator. But this will help you guesstimate where to set the pointer between two degree marks on the miter gauge scale and the blade tilt scale.

Cutting the Angles

Now for the easy part — and the part I always forget. Once you've set the miter and bevel angles, there's a nifty trick for cutting both the right and left miters on the frame members without having to change settings. It's all in how you flip the board.

I prefer to cut compound miters with a long miter gauge extension (a board fastened to the face of the miter gauge) that extends well past the blade. This not only provides better support, it gives you a surface to fasten a stop so you can make precise duplicate parts.

To make the first cut, place the board against the miter gauge extension and feed it into the blade, cutting through both the board and the extension. Flip the board edge for edge, so another edge rests against the extension and another face rests against the table. The board ends should remain oriented as they were. Position the board for the second cut and feed it into the blade. If the second cut is near the end of the board, and there isn't enough wood for you to hold it safely against the extension, move the miter

Tape the pieces together at the corners and inspect the joints. If you find any gaps, adjust the bevel angle in tiny increments and cut new test pieces until the gaps disappear.

gauge to the other slot on the opposite side of the saw blade. You won't need to change the settings.

Adjusting the Angles

Before cutting good wood, it's always a good idea to make some test cuts to check your setup. I cut enough small identical pieces to make one frame, then assemble it with masking tape to check the joints. If the settings are off, one of the compound miter joints will gap. When the gap opens to the outside of the frame, increase the bevel angle. When it opens to the inside, decrease the angle. This may change the slope very slightly, but usually not enough to notice.

Assembling the Frame

The best clamps I've found for gluing up compound miters are band clamps. If the slope is fairly steep, wrap the band clamps around the corners of the frame as you would when assembling a box. As the slope becomes shallower, however, the clamps tend to slip up the slope. When this is the case, wrap the clamps around edges of the assembled frame members, like the ribbons on a Christmas present. Be careful not to overtighten the clamps or the frame members will bow. If you can't get enough clamping pressure without bowing, use additional band clamps and position them as close to the corners as possible. Control the bowing by wedg-



ing a scrap between opposite members to act as a temporary brace.

In some compound miter assemblies with multiple sides, I've seen craftsmen put the members together in several steps. They assemble two halves, then sand or joint the adjoining surfaces of the halves for a tight fit, and glue the halves together. This is commonly done when glu-

ing up blanks for lathe turnings where the strength of the glue joints are critical and even the tiniest gap in a joint could spell disaster when the stock is spinning at a high speed. **PW**

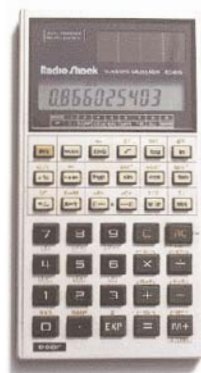

To calculate compound miter angles, you need a scientific calculator (about \$12 at most office supply stores) with SIN, COS, TAN, and INV buttons. On some calculators, the INV button is labeled FUNC for "function." If you have a computer and use Microsoft Excel software, you can download a simple Compound Miter Calculator that I wrote from the Pop Wood web site: www.popwood.com

COMPOUND MITER CHART FOR THE TABLE SAW

Slope	4 sides butted		4 sides mitered		5 sides mitered		6 sides mitered		8 sides mitered	
	Miter ang	Bevel ang	Miter ang	Bevel ang	Miter ang	Bevel ang	Miter ang	Bevel ang	Miter ang	Bevel ang
0			45	90	54	90	60	90	67.5	90
5			45.11	3.53	54.1	2.94	60.09	2.5	67.58	1.91
10			45.44	7.05	54.42	5.86	60.38	4.98	67.81	3.81
15			45.99	10.55	54.94	8.75	60.85	7.44	68.19	5.69
20			46.78	14	55.68	11.6	61.52	9.85	68.73	7.52
25			47.81	17.39	56.64	14.38	62.38	12.2	69.42	9.31
30	49.11	48.59	49.11	20.7	57.82	17.09	63.43	14.48	70.27	11.03
35	50.68	42.14	50.68	23.93	59.24	19.7	64.69	16.67	71.26	12.68
40	52.55	35.93	52.55	27.03	60.9	22.2	66.14	18.75	72.4	14.24
45	54.74	30	54.74	30	62.81	24.56	67.79	20.71	73.68	15.7
50	57.27	24.4	57.27	32.8	64.97	26.76	69.64	22.52	75.09	17.05
55	60.16	19.21	60.16	35.4	67.38	28.78	71.68	24.18	76.64	18.26
60	63.43	14.48	63.43	37.77	70.04	30.59	73.9	25.66	78.3	19.35
65	67.09	10.29	67.09	39.86	72.93	32.19	76.29	26.94	80.07	20.29
70	71.12	6.72	71.12	41.64	76.05	33.52	78.83	28.02	81.94	21.07
75	75.49	3.84	75.49	43.08	79.35	34.59	81.5	28.88	83.88	21.7
80	80.15	1.73	80.15	44.13	82.81	35.37	84.27	29.52	85.89	22.12
85	85.02	0.44	85.02	44.78	86.38	35.82	87.12	29.87	87.93	22.43
90	90	0	90	45	90	36	90	30	90	22.5

Slope	10 sides mitered		12 sides mitered		16 sides mitered		20 sides mitered		24 sides mitered	
	Miter ang	Bevel ang	Miter ang	Bevel ang	Miter ang	Bevel ang	Miter ang	Bevel ang	Miter ang	Bevel ang
0	72	90	75	90	78.75	90	81	90	82.5	90
5	72.06	1.54	75.05	1.29	78.79	0.97	81.03	0.78	82.53	0.65
10	72.26	3.08	75.22	2.58	78.92	1.94	81.13	1.56	82.61	1.3
15	72.58	4.59	75.49	3.84	79.12	2.9	81.3	2.32	82.75	1.94
20	73.02	6.07	75.87	5.08	79.41	3.83	81.53	3.07	82.95	2.56
25	73.59	7.5	76.35	6.28	79.78	4.73	81.83	3.79	83.2	3.16
30	74.28	8.89	76.94	7.43	80.23	5.6	82.19	4.49	83.5	3.74
35	75.1	10.21	77.62	8.54	80.75	6.42	82.61	5.15	83.84	4.3
40	76.02	11.46	78.4	9.58	81.34	7.2	83.08	5.77	84.24	4.81
45	77.06	12.62	79.27	10.55	81.99	7.93	83.61	6.35	84.68	5.3
50	78.2	13.7	80.23	11.43	82.71	8.6	84.19	6.88	85.16	5.74
55	79.44	14.67	81.26	12.24	83.49	9.2	84.81	7.36	85.68	6.14
60	80.77	15.53	82.37	12.95	84.32	9.73	85.47	7.79	86.23	6.5
65	82.18	16.27	83.54	13.56	85.19	10.19	86.17	8.15	86.82	6.78
70	83.66	16.88	84.76	14.09	86.11	10.56	86.9	8.45	87.42	7.05
75	85.19	17.38	86.03	14.49	87.05	10.87	87.65	8.7	88.05	7.24
80	86.77	17.72	87.34	14.75	88.02	11.09	88.42	8.89	88.69	7.39
85	88.38	17.91	88.66	14.97	89.01	11.17	89.21	8.96	89.34	7.5
90	90	18	90	15	90	11.25	90	9	90	7.5

Note: The slope is measured from horizontal, with the assembly resting on a bench or work surface.





two tub tables

Tricks to making compound miters right the *second* time.

I suspect most woodworkers would rather spend an entire day hand sanding than get involved with a project that requires cutting compound miters. And I think they have good reason. Not only are compound miters hard to get right (although I hope to change that for you with this article and the accompanying one by Nick Engler) but just about every book or magazine article has a different way of doing them. To complicate matters further, some sources even give you conflicting settings for the blade tilt and miter gauge.

Over the course of the last three years I have evolved a system that has two basic rules to follow to make cutting these pesky joints nearly bulletproof. First, make a mock-up — a miniature one — once you have made your blade and miter gauge settings. Chances are it won't be perfect the first time so you tweak your adjustments until the mock-up is right. Second, don't change the settings in order to cut the other side of the part once the first side is cut. Turn the piece over and move it to the other side of the blade instead. Why? Because it's next to impossible to find the perfect setting on the opposite side of the miter gauge. The same is true for the track arm of a radial arm saw or the miter setting of a compound miter saw.

Armed with these rules, your compound miters have



Photos by Al Parrish

by Steve Shanesy

SOLID WOOD TUB TABLE

No.	Item	Dimensions T W L	Material
4	Sides	$\frac{3}{4}$ " x 22" x 14"	Walnut
4	Side crowns	$\frac{3}{4}$ " x 22" x 2 $\frac{1}{4}$ "	Walnut
1	Top	$\frac{3}{4}$ " x 22" x 22"	Walnut
4	Buildups	$\frac{3}{4}$ " x 1 $\frac{1}{2}$ " x 21 $\frac{5}{8}$ "	Walnut
1	Bottom	$\frac{1}{4}$ " x 14 $\frac{1}{4}$ " x 14 $\frac{1}{4}$ "	Plywood



Make the first cut with the outside face down, the bottom edge against the fence and the panel to the left of the blade.



To make the second cut, turn the panel so the outside face is up and the top edge is against the miter gauge fence. Cut the other three panels the same way.

a 90 percent chance of success. The last 10 percent comes from making sure your stock is flat, you hold it firmly when cutting and, of course, you find the "right" angle settings. I say "right" for two reasons. One, you may go to a source that isn't correct. Second, the miter degree markings on most woodworking tools are inaccurate or too crude for the "on the money" setting a tight-fitting compound joint requires.

A Tale of Two Tubs

In this article I'll show you how to make

these two occasional tables. One uses black walnut and has sides that square up at the top in what I call a "crown." The second, which is easier to build, is made from birch plywood and runs the angle all the way until it meets the lid, which on both tables is removable for storing things. Further, the second table is butt-jointed at the sides, not mitered like the walnut version. To keep everything straight, I'll describe the steps in constructing the walnut tub table first.

Start by gluing up five panels, four of

which are slightly more than 22" wide and 17" long. Make the panel for the top oversized so you can cut it to size after the base is assembled. As you prepare your stock and glue up the panels, make sure your panels stay flat, or the angle you cut later for the miter joint will not be true. You'll note that the grain on the walnut table runs up and down and is continuous from the angled sides to the crown at top. The length of the side panels you glue up will accommodate the crown.

Once glued, sand your panels just shy of your final grit. Next, take the panels to the table saw and cut them square but still oversized. Now crosscut the lower portion of each side from the "crown" piece that will be glued back later. Make this cut at 14 $\frac{1}{4}$ ". This length will allow you to make angle cuts cross grain at the bottom edge and the miter edge where the top piece joins the side and not lose any height.

Next cut the crown pieces to length (and I do mean length because it is the dimension that goes with the grain) to 2 $\frac{1}{4}$ ". Now set the table saw's blade to 15 degrees and cut this angle on the lower edge of the sides' bottom on all four pieces. You should remove only enough material to make the angle and no more. Now change the blade angle to 7 $\frac{1}{2}$ degrees and cut the complementary angles for the joint where the side and crown join.

Cut the Compound Miters

Set the crown pieces aside for now. Prepare

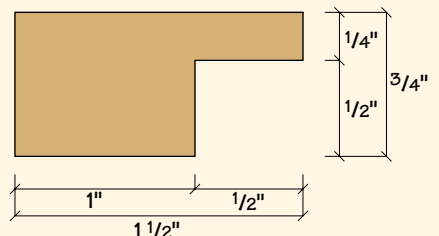
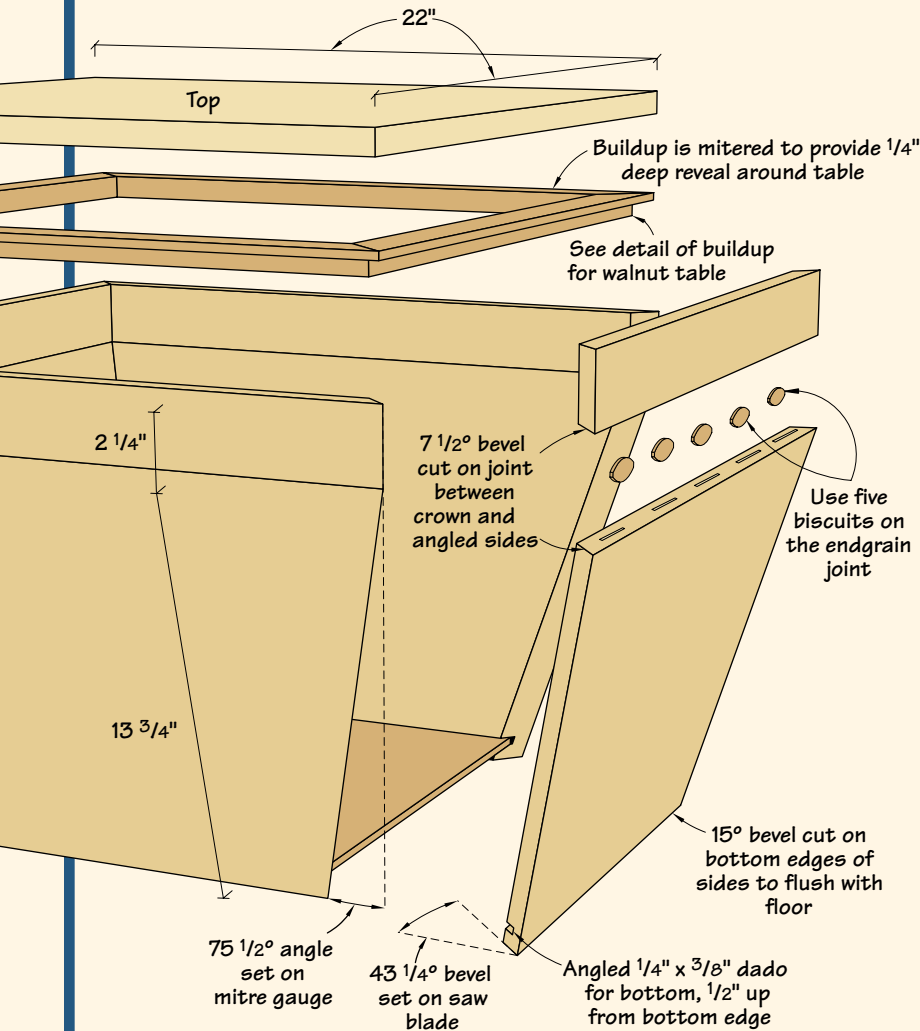

Detail of buildup, solid wood table



Carefully cut and fit each of the four pieces for the "crown." Dry-assemble them in place before gluing, but wait until the glue on the sloping sides has completely cured.

PLYWOOD TUB TABLE

No.	Item	Dimensions T W L	Material
2	Sides	3/4" x 22" x 16"	Plywood
2	Sides	3/4" x 20 1/2" x 16"	Plywood
1	Top	3/4" x 22" x 22"	Plywood
4	Buildups	1/2" x 1/2" x 21 5/8"	Poplar
1	Bottom	1/4" x 13 9/16" x 13 9/16"	Plywood

Note: sizes given include thickness of veneer added after cutting.

to the right end of the miter gauge fence that will give you the 22" finished width at the top after making the second miter cut. I made a 15-degree bevel cut on the stop block I used, which prevented it from slipping during the cut. Now study the photos to figure out the correct cutting and turning sequence for the sides.

Before moving any saw settings, use masking tape to dry assemble the four sides to make sure everything checks out. Before gluing the sloping sides together, cut biscuit slots in the joint where the sloping side and its mating crown piece go together. I used five biscuits evenly spaced on each joint. Remember, this is virtually an end-grain butt joint so you must rely on the biscuits to make a sound joint. Be sure and angle the fence of your biscuit joiner to 7 1/2 degrees for proper alignment. Cut the dado for the bottom. See the story on

a piece of stock that's at least 42" long to screw on to your table saw's slot miter gauge. Put at least 30" to the right side. Run your table saw blade over to 43 1/4 degrees. Set your miter gauge to 75 1/2 degrees on the left scale of miter gauge. Now you are ready to make a small model to check your angle settings. I suggest using a piece of scrap plywood about 6" wide and about 30" long.

Make your first cut by trimming one end of the sample board. Now clamp a stop block about 6" to the right of the saw kerf in the fence. Next take the sample board and turn it over and place the just-trimmed end against the stop block and make a second cut. Again, turn the sample board over, place it against the stop block and make another cut. Repeat two more times and your four sample sides will be cut.

Now place all four sides together and check for gaps in the mitered corners. If there's a gap in the inside of the miter, slightly reduce the angle of blade tilt. If open on the outside, increase the blade tilt angle. For a slight opening, 1/4 to 1/2 degree should be all the correction needed. Continue adjusting and checking until there are no openings in the joints or rocking motion when holding them in your hands and applying pressure.

Cut Your Good Panels

Because you have already cut the bevels on the top and bottom edges of the sloping side panels, you have designated which sides face out. In cutting the compound miters, you'll need to keep track of which side faces where.

After the first cut, clamp a stop block

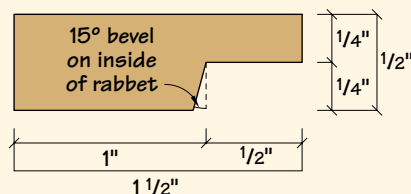

Detail of buildup, plywood table

Buildup is mitered to provide 1/4" deep reveal around table

See detail of buildup for plywood table

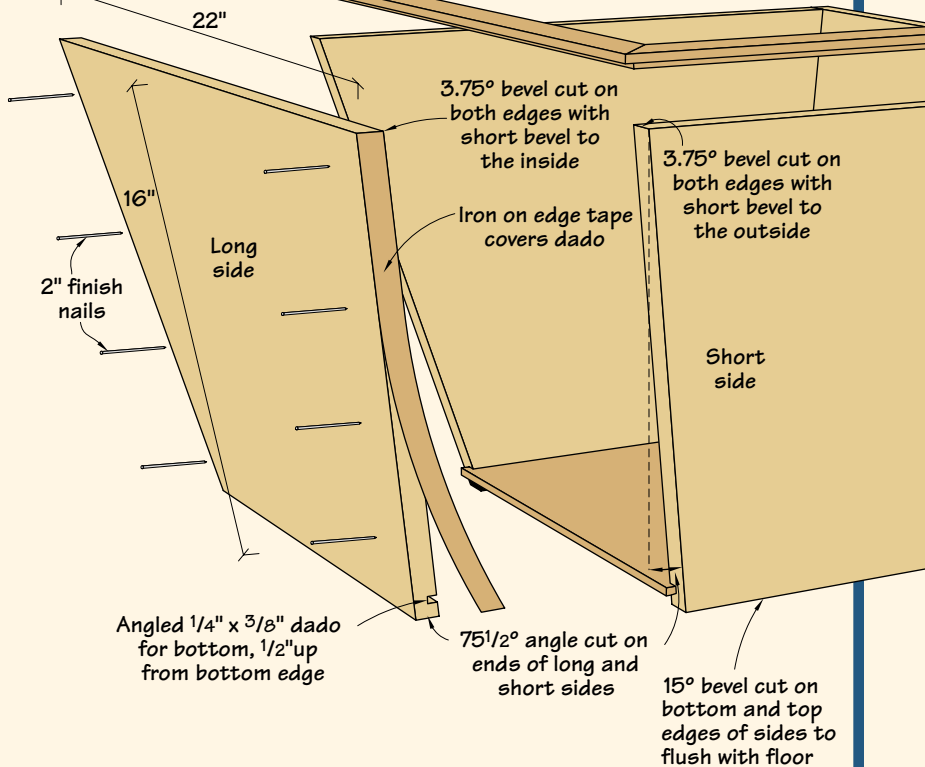

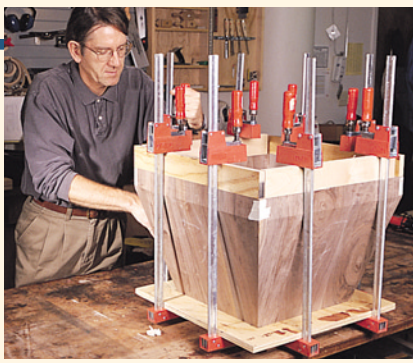

Use a small amount of a good polyurethane glue on the joints and tape the corners as shown in the photo before applying glue. After all the surfaces are glued, set this "crown" in place and clamp it down. Check to make sure the corner joints are nicely closed. If they need help, clamp across them as needed.



Miter the ends of the strips and screw them to the top as shown. Use elongated slots for the screw clearance holes where top expansion is expected.



After attaching the lid strips to the lid, trim any overhang on the miters with a chisel.

the plywood table to see how this is done.

Glue the Compound Miters

The best way to glue up this awkward assembly is to tape the joints with masking tape. First lay out the parts face up and apply two layers of long tape strips along the length of the joint. Make sure the sharp edges are touching and that the top and bottom edges are aligned. With the last joint still open, carefully turn the entire

taped-up assembly over and spread wood glue in the joints. Now tip the pieces up and slide the bottom in place before taping the last joint. When it's taped up, check for any open joints that could be caused by being out of square or not taping the joint edges close enough.

While this dries, begin cutting the crown pieces to finished size. Each piece needs a 45-degree miter joint. Be sure to match the grain with the sloping portion of the side. To glue the crown to the base, cut a piece of plywood that's 22" square, the same size as the top area. This piece gives you the clamping surface you need to draw the crown to the sloping sides. Stack a few pieces of wood under the base so you can get clamp ends under it.

Complete the Top

In addition to cutting the top to finished size, you must also add four strips to the underside to create the small "reveal" or "quirk" detail between the top and base. These strips also serve to keep the top in position because they nest inside the sides.

Study the drawings of these strips on the previous pages. Because the reveal is 1/4" square, cut your wood strips so you create a rabbet that leaves 1/4" thickness and sets back 1/2". Make two strips this way. Make the other two strips you need with a 5/8" setback and use these on the sides of the top that run with the grain direction. This additional space will allow the top to expand in humid conditions without pushing out the sides, ruining the miter joints. The top remains loose for easy removal.

To prepare the pieces for finishing, sand up to 150 grit. Be careful sanding at the transition point of the sloping side to the crown. You want to maintain a crisp joint line. The walnut had both great figure and color. So I simply applied two coats of clear finish and let the beauty of the wood shine through.

For me, the two rules of making good sound compound miter joints worked perfectly again. Yes, I had to fine tune my setup after I made my mock-up, and I didn't change any settings once I had it right. The results were dead on and my frustration from not "getting it right" was virtually non-existent. Follow these simple rules and you'll get the same results. **PW**

BUILDING THE PLYWOOD TUB

The plywood tub table is constructed much like the solid walnut version with a few exceptions. If you plan to build this simpler version, familiarize yourself with construction of the walnut version as well.

The main differences are the absence of the "crown" and the joinery for the the sloping sides. Instead of a compound miter, the sides are butt-jointed together. The two sides that overlay the adjoining sides are simply 1 1/2" wider so the overall width of all the sides remains equal when assembled.

To cut the angles on the sides, prepare the miter gauge fence as described earlier. Only this time, set the gauge degree setting to 75 1/2 degrees, and tilt the blade to 3 3/4 degrees. Make the cuts exactly as described previously.

There's one more modification to this unit. In making the pieces that create the reveal and are attached to the underside of the top, cut the rabbet using a 15-degree angle as shown in the diagram.

To color the birch plywood, I used a brown walnut stain before clear coating. Make sure you give the stain at least eight hours to dry.



Cutting the dado for the bottom applies to both tables. Change the angle setting of the saw to 15 degrees in order to cut a dado to hold the 1/4"-thick bottom in place. Set the fence so that the bottom will start 1/2" up from the bottom. The blade height should be 3/8". Make two passes using a regular thickness blade to allow the bottom to slip into place. While you have the blade set, cut your bottom with a 15-degree bevel on all four edges.



Before gluing and nailing the sides together, use iron-on veneer tape on the edges of the sides that will be exposed. And when assembling, make sure your parts are aligned exactly flush before hammering the nails home. After assembly, use more veneer tape on the top edges of the sides and on the edges of the top itself.

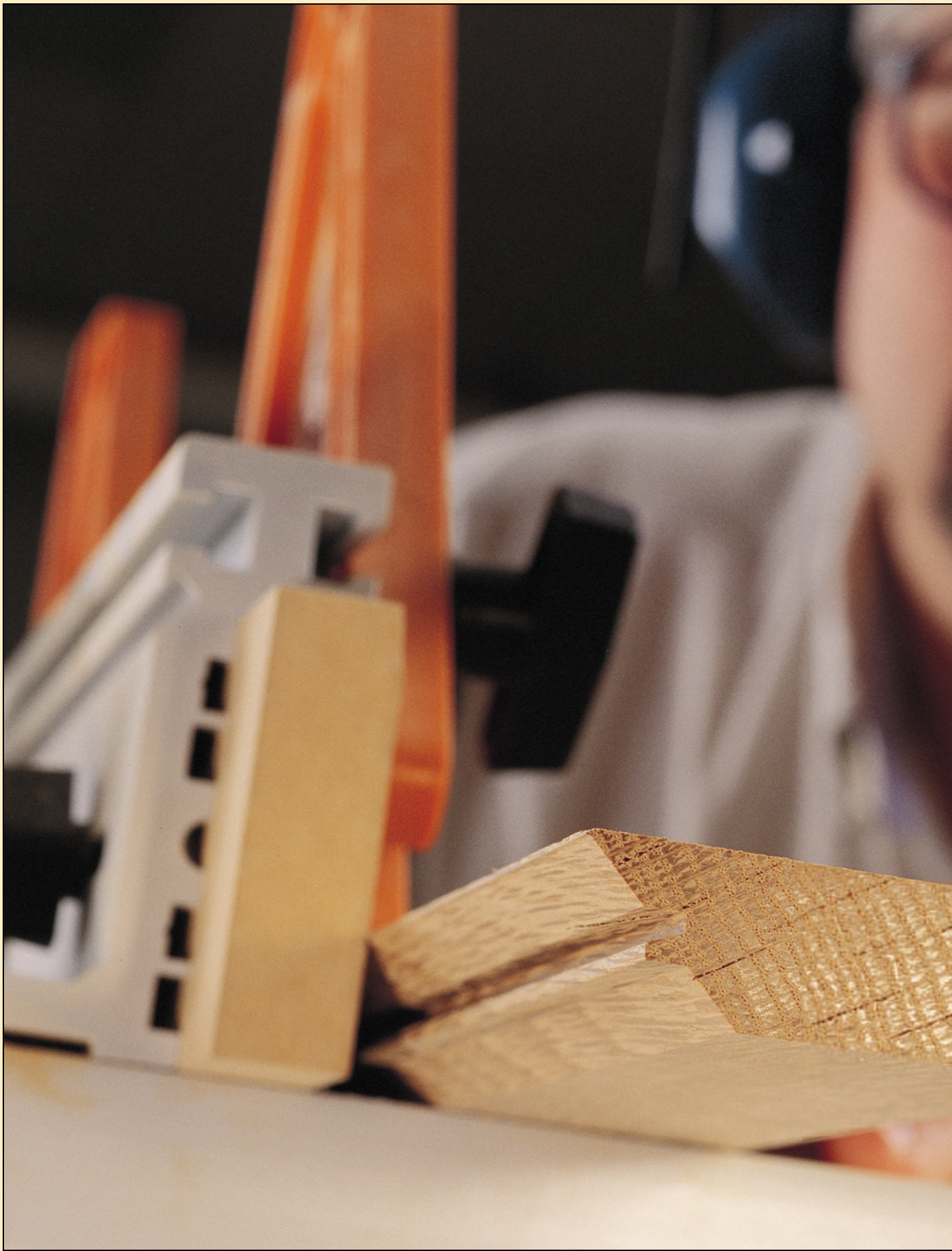

Quadrilinear POSTS

You need just one router bit to build a rock-solid post that shows the ray flake in quartersawn oak on all four sides.

Woodworkers who build Arts & Crafts furniture look for wood that is loaded with ray flake — the silvery stripes that show up in quartersawn oak. But unfortunately, Mother Nature decided that ray flake can only appear on the quartersawn faces of a board, not the edges. So when woodworkers build a piece of furniture using thick posts (such as a Morris chair or the hall tree featured in this article) they have three choices: One: learn to live with ray flake on only two sides. Two: Apply quartersawn veneer to the plain sides. Or three: learn quadrilinear post construction.

The quadrilinear post was used in Arts & Crafts furniture by Leopold Stickley (brother of Gustav), and it allows you to use four $\frac{3}{4}$ " or thinner quartersawn pieces to form a post with each face showing the ray flake. While simply mitering the long edges of the pieces to form the post would work, it's difficult to align the miters and keep them tight during glue-up. You could

cut a spline in the four mitered edges, but quadrilinear post construction has a couple advantages over splines. First, it's a historically accurate way of building the posts. Also, if you put a small block of wood in the cavity in the middle, you can use the end of the post as an attractive exposed tenon through a chair arm, for example.

The most difficult part of making the quadrilinear post is setting up the bit for the first cut. But first, the bit. We used a Baby Lock Miter bit from CMT. It's a bit expensive (\$99, item #855.504.11, 888-CMT-BITS, www.cmtusa.com). This bit can be used on material from $\frac{3}{8}$ " to $\frac{3}{4}$ " thick, so you'll find other uses for it in your shop.

To show how simple this procedure is, we built this Frank Lloyd Wright-inspired hall tree using quadrilinear posts. After the posts are built, most of the project is just nailing pieces to other pieces.



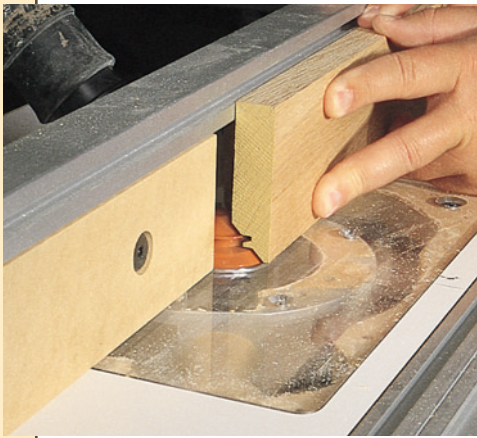

Set up the router table by running a piece on edge over the knife. The cut should leave the interlocking tongue and groove in the center of the miter.



To check your setup, the point of the miter must come to a sharp edge. The edge shown top left is not sharp enough and the fence needs to be adjusted to leave an edge as shown above right.

Post Time

First rip eight pieces to form the sides of the two vertical posts. Cut the pieces longer than required, and to make the setup easier, run the material shy of $\frac{3}{4}$ " thick — $\frac{11}{16}$ " is fine. Depending on the size of your router, it's a good idea to first cut a 45-degree bevel on the long edges of each side using your table saw. This cut needs to be about $\frac{1}{8}$ " shy of an actual miter cut (see opening photo) to leave enough wood for the locking part on the bit.

With your pieces cut, set up the lock-miter bit in your router table, with the extreme ends of the cutting edge even with the router table fence and the table sur-

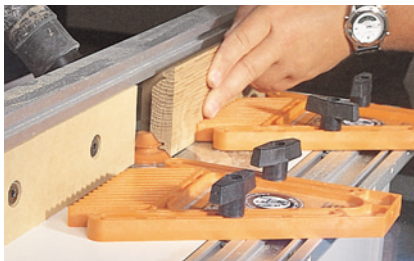

Finger boards make this router-table process safer and ensures an even cut all along the miter.



After running two opposing boards through upright, run the other two boards making up the post flat against the router table.

face. For the best lock-miter setup, the center of the cutting edge should be at the center of the mitered joint. This means adjusting both the fence and bit height until the setup is just right. Don't try this on your good pieces of white oak. Run some scrap material to the same thickness as your test pieces. Run one piece on edge against the fence, and another piece flat against the table, without changing the bit. Put the pieces together and check the fit. The joint should come to a sharp point at the outside. If it isn't perfect, the post will take on a rectangular shape rather than a true square. Be patient and set the table correctly.

When the router table is set up correctly, add feather boards to your setup. Not only is this a good idea for safety, but when running lengths of wood more than 6 feet long, the material has a tendency to move away from the bit. This leads to a sloppy or wavy joint. The feather boards hold the material tight against the fence and bit through the entire cut.

You're now ready to run your post sides. On each post two opposing sides will be run through the router table lying flat, with the good face up. The adjoining two sides will be run on edge with the inner face against the fence. Run the pieces at a steady pace, allowing the router bit to cut with-

out difficulty. We used a 2 hp (12 amp) router, which had enough power to do the job without much lagging.

With the miters cut it's time to enjoy one of the other benefits of a lock-miter joint. Glue-up is pretty simple, and more tidy than normal. By running a bead of glue into the groove formed by the bit, the glue squeeze-out to the outside of the post is minimal.

In addition, the lock miter allows you to use only a half-dozen clamps to glue up the posts, where a standard mitered post would require dozens of clamps. Glue up your posts, and you're ready to move on to the rest of the hall tree.

The lock-miter joint is also useful in making jewelry boxes, humidors, small chests and dozens of other projects. Not to mention the many Arts & Crafts pieces that will benefit from quadrilinear posts.



Your finished product will pull together during glue-up with simple clamp pressure (placed across the left and right pieces as shown here). Note that the adjustment on these cuts is imprecise as the corners of the miters do not meet evenly, forming more of a rectangle than a square. Take your time and set it up right.

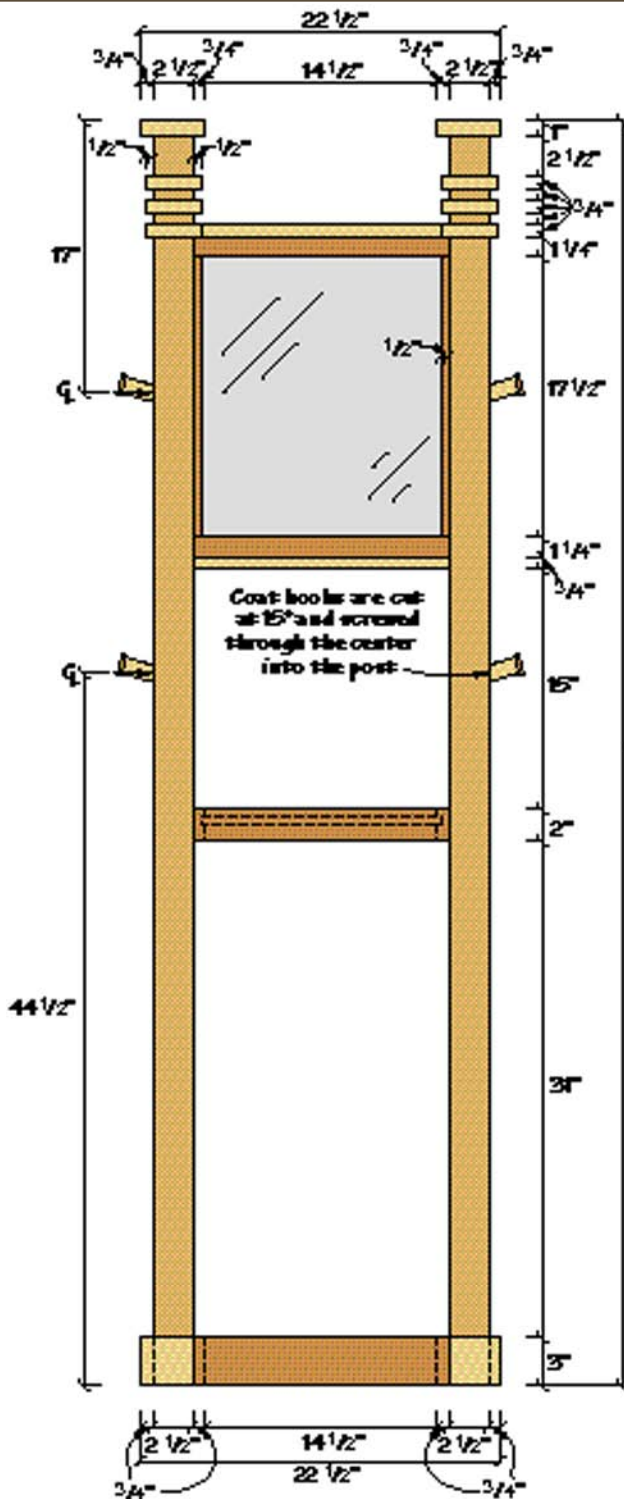

Elevation

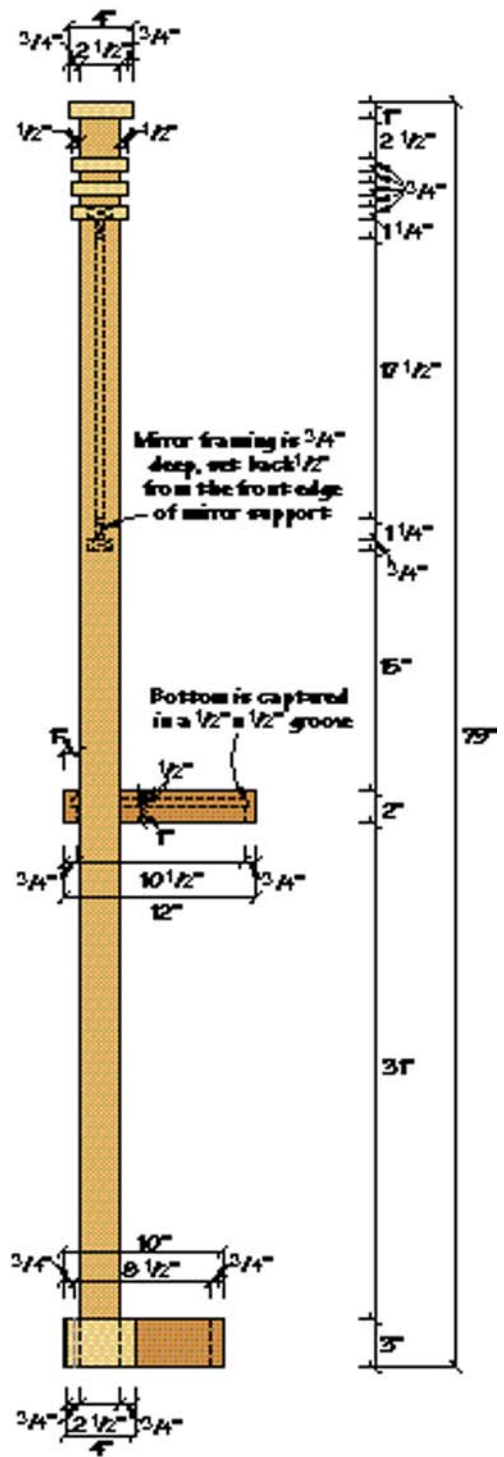

Profile

SCHEDULE OF MATERIALS: WRIGHT HALL TREE

No.	Item	Dimensions T W L	Material				
8	Post sides	3/4" x 2 1/2" x 78"	White oak	22	Band mouldings	1/2" x 3/4" x 3 1/2"	White oak
2	Mirror supports	3/4" x 1 3/4" x 16"	White oak	4	Band mouldings	1/2" x 3/4" x 1"	White oak
2	Mirror supports	3/4" x 1 1/4" x 16"	White oak	2	Mirror stops	1/2" x 3/4" x 17 1/2"	White oak
2	Shelf front and back	3/4" x 2" x 16"	White oak	2	Post caps	1" x 4" x 4"	White oak
2	Shelf sides	3/4" x 2" x 12"	White oak	4	Coat hooks	1" x 1" x 2"	White oak
1	Shelf	1/2" x 11 1/4" x 15 1/4"	White oak	4	Hook caps	1/4" x 1 1/4" x 1 1/4"	White oak
2	Base front and back	3/4" x 3" x 16"	White oak	4	Base mouldings	3/4" x 3" x 3 1/4"	White oak
2	Base sides	3/4" x 3" x 10"	White oak	2	Base mouldings	3/4" x 3" x 4"	White oak
				1	Back	1/4" x 16" x 20"	Ply



If ever there was an invaluable tool that was amazingly cheap, it's dowel centers. Costing less than \$5, a set of dowel centers allows you to unerringly locate a dowel joint with very simple tools. I used dowel centers to locate the placement of the mirror supports.



With the hall tree assembled, the banding details and caps are added. On the bands the holes made by the micro pinner are all but invisible.

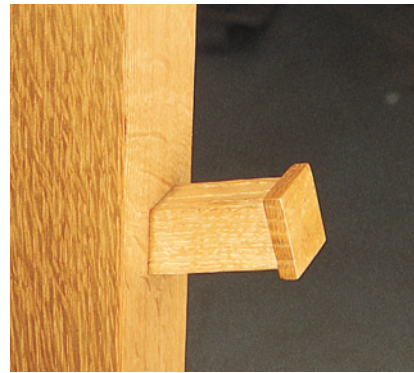

When you pin the caps onto the coat hooks, make sure you locate the pins to avoid the screw in the center. The thin pins are easily redirected by the grain of the wood, and hitting a screw could easily cause the pin to blow out the side of the hook.

The Rest of the Hall Tree

After constructing the quadrilinear posts, building the hall tree is simple. In fact, it's mostly nails and a few dowels. Though the hall tree we've shown is not an original Arts & Crafts design, it does use an architectural detail found in Frank Lloyd Wright's office at his Oak Park, Ill., residence. The triple-banded column with a top cap also appears in work designed by Wright for the Dana-Thomas house and other Wright locations. The banding appears as a distinctive design in much of his Prairie-style work, and the cantilevered shelf also echoes other work of the period.

Cut the pieces for the upper and lower mirror supports, the shelf and the base. The mirror supports are two pieces glued together in a long-grain joint to form a "T." Clamp these up with the 1 1/4"-wide piece on edge, centered on the 1 3/4" piece. Throughout this project I used a 23-gauge headless micro pinner from Accuset. The pinner leaves an almost invisible hole in the wood and holds the pieces in place while the glue dries. You can add a few headless pins to the mirror supports to hold them in place while the glue dries.

The shelf and base are mitered frames held together by biscuits at the corners. One difference between the two assemblies is that the shelf has a 1/2" x 1/2" groove run 1/2" down on the inside face of each piece. This groove will capture the piece to form the shelf surface. Cut the grooves in the shelf frame pieces on the table saw or with a router.

With the grooves done, cut the shelf to 11 1/4" x 15 1/4" to leave a space to allow the solid wood shelf room to expand during atmospheric changes. Cut the biscuit slots, then glue up the two frames with the shelf piece in the groove, but don't use glue in the groove.

Using the diagrams, locate the positions for attaching the two mirror supports, the shelf and the base. The base frame and shelf should extend 1" beyond the rear surface of the posts. The mirror supports are attached to the posts with 3/8" dowels. Screw and glue the shelf in place from the underside of the shelf. Dowel the base in place, or use glue, screws and wooden plugs to hide the screw heads.

Next cut and attach the decorative 1/2" x 3/4" banding, base and post caps. I applied a couple dabs of glue to each piece and tacked them in place using the micro pinner. The two last pieces of moulding to attach are the vertical mirror stops. Cut them to size and fit them for length between the upper and lower mirror supports, then glue them in place.

For the coat hooks, cut the four 1" x 1" pieces to 2" lengths, cutting one end of each at a 15-degree angle. Next chuck a

3/16" bit in your drill press and set up a fence and stop to allow you to drill through the center of each piece, starting the hole from the angled end. Drill the hole through the piece. Then chuck a 3/8" bit into a hand drill and drill from the square end of the piece into the existing hole to form a countersink that's 1/4" deep.

Determine the location of the hooks on the posts, and use a 1/8" drill bit to start a pilot hole in the post. To drill the pilot hole at the proper angle, slide the coat hook over the drill bit and align the angle by sight as you drill. To hide the screw hole and finish off the coat hooks, cut the 1/4" x 1 1/4" x 1 1/4" caps and glue and tack them in place, again using the micro pinner.

To finish the piece, I first applied a wiping varnish, which gave the oak a slightly aged look. Then, to protect the project further, I applied a couple coats of satin spray lacquer.

The last step is to fit the mirror and the 1/4" plywood mirror backer and put the mirror in place. I used glazing points to hold the mirror and backer in place. **PW**



The base moulding doesn't really add any stability, but it does finish off the look of the base nicely.



Vaughan Bear Saws

When we got a couple of Bear saws from Vaughan to test about two years ago, I thought they would be just run-of-the-mill tools and wear out in a couple months. I was pleasantly surprised to find the blades to be quite stout — about twice the thickness of comparable entry-level saws. The downside to this extra thickness is that the kerf is a little wide for a Japanese-style saw, which makes it a little hard to start a cut. Once you start, though, the saw cuts true and clean. The wide kerf allows the saw to “turn” during your cut to get back to a marked line. Amazingly, the

replaceable blades have actually stayed sharp to this day.

Other nice features include a cushy rubber grip, which is a nice feature for sweaty hands. Also, you usually have to drill a hole in a traditional Japanese saw to hang it. Vaughan has done this for you on the Bear. My one gripe is that there isn't a fine-toothed blade available for the Ryoba or larger Dozuki saws. With a Ryoba (double edged), a Dozuki (single edged) saw in your toolbox, you should be able to handle any hand-cutting task.

—Jim Stuard

NICE FEATURES: Cuts clean; comfortable grip. The blade can be steered in the cut.

RECOMMENDED MODIFICATIONS: Make a fine toothed version of the larger saws.
 Vaughan 815-648-2446

Veritas Wheel Marking Gauge

If you cut mortises by hand, you need a stout chisel, a comfortable mallet and this handy little tool, the Veritas Wheel Marking Gauge. Like most woodworkers, I learned to lay out my mortises and tenons with a wooden marking gauge that had a fixed pin. I also learned to constantly fight the chattering pin and its tendency to follow the wood's grain. The Wheel Marking Gauge is different because it slices the grain instead of tearing at it. As a result, your lines are always parallel to your edge, and the marks are always sharp. The tool does take a little getting used to. You quickly find that pulling the tool in one direction will cause the screw that holds the circular blade to loosen (it's a simple thing to retighten it). And I wish that the post had measurements to help get you in the ballpark when setting up the tool. But for less than \$20, I think you'll find this tool to be remarkably well-made and constantly in your hand as you lay out your joints.

—Christopher Schwarz



NICE FEATURES: Cuts perfect layout lines for joints. It's a well-made tool that's easy to use.

RECOMMENDED MODIFICATIONS: We wish the post were marked in inches.
 Lee Valley Tools 800-871-8158. Item # 05N33.01, \$18.95.

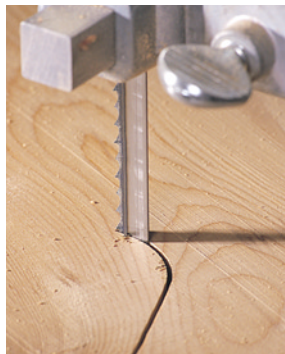

Timber Wolf Bandsaw Blades

When we saw these blades demonstrated over three years ago we knew we had to test them, and they knocked our socks off. To this day we continue to choose Gschwind Timber Wolf blades for our band saws. The silicon carbon steel provides a clean, straight cut that allows amazing flexibility for tight radius and scroll work. Even under low tension the blades cut true and with excellent quality. The blades hold an edge for longer life and don't heat up after extensive use, extending the life of the blade and avoiding wood and hand burns. Prices are around double the cost of a traditional band saw blade (\$25 per blade), but the performance provided keeps us going back for more. Timber Wolf blades are distributed by PS Wood Machines and are available at many woodworking supply locations. Check the company's web site to find a distributor near you, or shop direct from PS Wood.

—David Thiel

NICE FEATURES: Amazing turning ability, low-tension performance and clean cut.

RECOMMENDED MODIFICATIONS: A little lower price would be nice.
 PS Wood 800-939-4414,
 www.pswood.com

ABOUT OUR ENDURANCE TESTS

It's nice to know how a new tool performs, but most woodworkers also want to know how long the tool will last. Each issue we tell you about a tool that has stood up to regular use in our shop for at least one year. We tell you how the tool has fared, any recommendations we have and if the tool has passed the *Popular Woodworking* Endurance Test. —David Thiel, senior editor

woodcraft

Circle #115 on Resource Directory Coupon

Save Money—saw your own lumber.



Make Money—saw for others.

- Cut logs up to 28" D. x 11' L.
- Extra bed sections permit longer lengths.
- Easily transportable.
- Video available.

Free \$2! Catalog.

Prices & specifications subject to change w/o notice.

Wood-Mizer®
Number One in Worldwide Sawmill Sales
www.woodmizer.com

8180 W. 10th St. Dept. DF51
Indianapolis, IN 46214

Call for the location nearest you!
1-800-553-0219

\$4995

LT15G13 Personal Sawmill

In-stock for immediate delivery!

*LT15G13 electric start

HARDWOOD MARKETPLACE

NIAGARA LUMBER

YOU'LL APPRECIATE OUR DIFFERENCE
Prepaid Freight • Surfaced • Bundled • Shrink Wrapped • Guaranteed

- All lumber is Select and better grade, 4" and wider, averaging 6"-7" in width, lengths are 6'-8'. All stock meets or exceeds National Hardwood Lumber Assoc. grade rules.
- All domestic lumber is Northern Appalachian grown, exhibiting characteristics of fine grain, texture and uniform color.

Visa/Mastercard/Discover accepted
NIAGARA LUMBER & WOOD PRODUCTS, INC.
47 Elm Street
East Aurora, NY 14052
Call Toll-Free 1-800-274-0397
www.niagaralumber.com

Reader Service #147

WEST PENN HARDWOODS, INC.

SATISFACTION GUARANTEED
NO MINIMUM ORDERS

QUARTER-SAWN WHITE OAK
HIGH FIGURE CURLY MAPLE

NOW ALSO EXOTIC SPECIES:
BLOODWOOD, BUBINGA,
JATOBA, SPANISH CEDAR, PADAUK,
PURPLEHEART, ZEBRAWOOD
AND MORE

ALL CREDIT CARDS ACCEPTED

CALL FOR FREE CATALOG & PRICING
TOLL FREE (888)636-WOOD (9663)
117 S. 4TH STREET
OLEAN, NY 14760

Reader Service #148

No Shortcuts

NEW DESIGN! Specifications in new Katana bits equal or exceed any now on the market.

INCLUDES A LIFETIME GUARANTEE!

- 1 Unique new **Safety Gauge Shank™**.
- 2 **Premium micro-grain carbide** yields a longer cutting life.
- 3 **Diamond honed** to a 600 grit mirror finish on CNC grinders.
- 4 **Non-stick coating** baked on to prevent residue build up.
- 5 **Precision ground** to a tolerance of +/- .005".
- 6 **High hook and shear angles** produce a clean cut.
- 7 **Anti-kickback design** forces smoother entry into stock.
- 8 **Balanced in excess of 25,000 RPM** for smooth routing.



FREE SHIPPING

FREE CATALOG!
1-800-533-9298

KATANA™

3 PIECE RAISED PANEL DOOR SET • 1/2" SHANK
\$129.95

ORDER ITEM #14502
WOOD BOX INCLUDED

KATANABITS.COM • AN MLCS COMPANY P.O. BOX 4053, RYDAL, PA 19046

Circle #107 on Resource Directory Coupon

Jet...the Power to Shape Your Ideas.
And the Store to Make Them a Reality.



The Jet store is now open with over 150 Jet products in stock, including best sellers and hard-to-find attachments. Complete product information including customer reviews make comparing products quick and easy. Visit the Jet store and see why Jet is one of the fastest growing brands in the industry.

Visit the Jet store at
www.amazon.com/jet

dust collectors jointers planers
saws wood lathes the Jet store
shapers sanders planer-molders

TOOL CRIB OF THE NORTH
PROFESSIONAL TOOLS & EQUIPMENT

Circle #140 on Resource Directory Coupon

They're Tools, Not Toys

One man's quest for the fabled 'simple shelves' leads to a life obsessed with cast iron, carbide and steel.

It started as some wild craving a little over five years ago, just as we were moving out of the apartment we had been renting, and into a small house with a garage. We were proud. It was our first house and more importantly, our first garage.

Even before we finished moving in, I knew what it was about the garage that had caught my attention — it needed a woodshop. Why I felt this, I have no idea, as I had only taken woodworking for one year back in my 4-H days.

The space for the shop seemed right. The garage was a bit longer than our vehicles and nearly 25 feet wide, just the right size for a small table saw and workbench. After all, I assured myself in a naive voice back then, that's all I would need. Just enough to build a few simple shelves for around the house and maybe a small wedding present or two. Simple items, really. Maybe a bookcase if I got ambitious.

It didn't take long before I had a contractor-style table saw and workbench in place and was turning out piles of sawdust faster than a colony of termites. I could turn a 1x4 into splinters and sawdust in mere minutes. Pretty soon, I was tracking sawdust through the house with the best of them. I followed the woodworking shows on television like they were a growing cult, envying every new little tool they pulled out of their workbenches.

Yet, the simple shelves I had envisioned had failed to materialize. A simple shelf just wasn't challenging enough. The shelves had to have curves in them or gallery rails across the top. Those meant getting a drill press, router, router bits and jig saws.

Pretty soon it became apparent that the little table saw wasn't going to cut it, so to

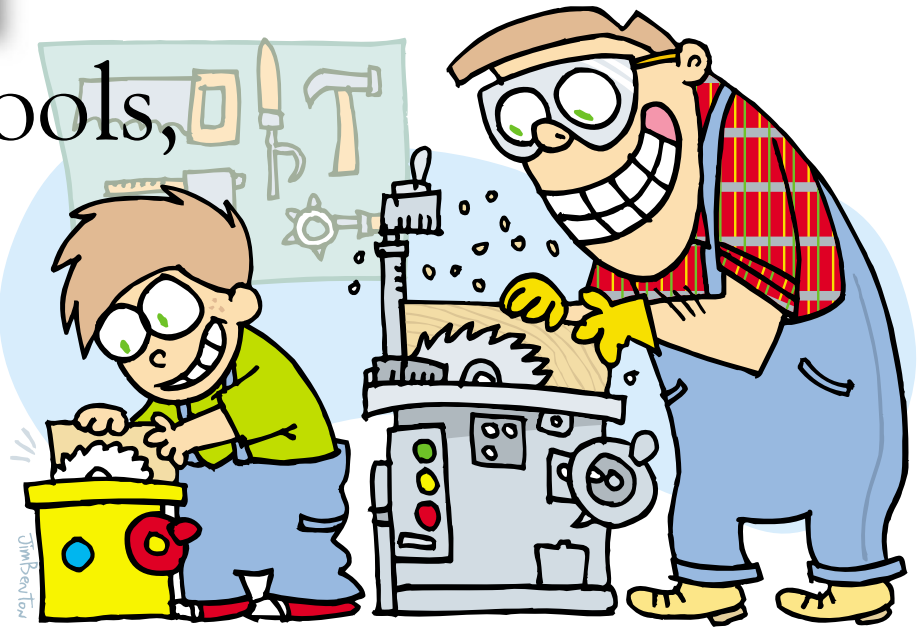

speak. Soon, a new saw was procured, one that took three of us to unload and required rewiring part of the garage. Projects began to grow in size and complexity. Still, no simple shelves.

Shortly after the new saw moved in, my truck moved out, as piles of wood and unfinished projects gradually spread. Soon, it was a struggle just to keep a space open for my wife's car. It wasn't long before that battle was lost, too.

A few years and a ton of sawdust later, we moved to a new house in town. My only requirement for a house as we looked was that it had to have a garage big enough for my shop. Once again, we began to move our belongings, with the shop taking a little longer than the rest of the house. An engine hoist was called in to move the saw. From the start, it was understood that my truck would likely never see the inside of the garage. My shop would take that half. Getting my wife's car in would be no problem, I assured everyone.

It's been in the garage, once. Last fall sometime as I recall.

I don't deny that my motto in life, and perhaps what will likely appear on my tombstone, is "every project should require at least one new tool." It's an adage that I adhere to stronger than carpenter's glue to wood.

But I began noticing something. Each new tool, large or small, would often incur the question from friends and neighbors, "So, what is that new toy for?" Or I'd be

asked, "Were you out playing in your shop with your toys?"

Toys? Woodworkers, professionals, amateurs or even those of us just doing simple shelves, do not work with "toys." Rather, we use tools. There is a marked difference that may not be noticeable to the untrained eye. My 5-year-old son, Peter, has toys: a little workbench with a plastic vise on the side, a plastic saw that makes little "sawing" sounds and even a little tool belt.

I, however, have a big workbench with a vise on the side, a bigger saw that makes really loud "sawing" sounds and a bigger tool belt.

See the difference?

These items are toys only if I fail to produce anything useful. Why, our new house is filled with spaces just waiting for these useful things to start coming out of the shop. There's a lovely space above the fireplace that's just begging for an elaborate upper mantle. There are spaces on walls for display cases. And, if I look around enough, I know I'll find a spot for that entertainment center I have plans for.

Then, there's the outdoor projects on my list: garden shed, gazebo, playhouse....

But it's late and I have to get out to my shop and play...work! I mean *work* in the shop for a little bit. You see, I've got this "simple" little shelf to make for some coffee mugs. **PW**

Guy Thompson, the former editor of the LaGrange Standard-News, works wood in LaGrange, Indiana.