

Fine Woody Working

April 1990, No. 81
U.S. \$4.95, Canada \$5.95, U.K. £2.95

Making a Writing Desk

Tablesaw Guards

Applying Gel Stains

A Shop-Built Shaper

Sharpening Chisels



Building Dining Chairs



**6" x 47"
HEAVY DUTY
JOINTER**



One of our most popular items!

MODEL G1182

REG. \$375⁰⁰
SALE PRICE \$345⁰⁰

F.O.B. Bellingham, WA or Williamsport, PA

MOBILE BASE MODEL G1744
ONLY \$89⁹⁵

10" SUPER HEAVY DUTY TABLE SAW
MODEL G1023



Great contractor's saw!

The ultimate in accuracy!

ONLY \$895⁰⁰

F.O.B. Bellingham, WA or Williamsport, PA

MOBILE BASE MODEL G1740
ONLY \$89⁹⁵

10" HEAVY DUTY TABLE SAW
MODEL G1022



REG. \$365⁰⁰

SALE PRICE \$355⁰⁰

F.O.B. Bellingham, WA or Williamsport, PA

MOBILE BASE MODEL G1739
ONLY \$89⁹⁵

6" x 48" COMBINATION SANDERS
MODEL G1014



9" Disc

Sanding belts & disks available

ONLY \$195⁰⁰

F.O.B. Bellingham, WA or Williamsport, PA

MOBILE BASE MODEL G1750
ONLY \$89⁹⁵

WOOD SHAPER



Perfect for custom work!

MODEL G1024

REG. \$275⁰⁰
SALE PRICE \$245⁰⁰

F.O.B. Bellingham, WA or Williamsport, PA

MOBILE BASE MODEL G1746
ONLY \$89⁹⁵

Surround yourself with the best!



IMPORTS, INC.

15" PLANER



2-Speed

MODEL G1021

NOW ONLY \$725⁰⁰

F.O.B. Bellingham, WA or Williamsport, PA

(Stand not included)

MOBILE BASE MODEL G1748
ONLY \$89⁹⁵

2 H.P. DUST COLLECTORS
MODEL G1029



REG. \$335⁰⁰

SALE PRICE \$295⁰⁰

F.O.B. Bellingham, WA or Williamsport, PA

Cleans up on the job!

Hoses and fittings available!

MODEL G1823 **ONLY \$129⁹⁵**

6" x 30" EDGE SANDER
MODEL G1531



ONLY \$395⁰⁰

F.O.B. Bellingham, WA or Williamsport, PA

For a smooth precise finish!

16" BAND SAW
MODEL G1538

REG. \$525⁰⁰

SALE PRICE \$495⁰⁰

F.O.B. Bellingham, WA or Williamsport, PA

1" blade capacity makes re-sawing a pleasure!

MOBILE BASE MODEL G1742
ONLY \$89⁹⁵



INCRA GAUGE



Invaluable tool for setting up router bits, table saws, where fine measurements are needed!

CARBIDE-TIPPED SAW BLADES



MODEL	BLADE SIZE	NO. OF TEETH	PRICE
G1239	7 1/4"	24	\$11.95
G1240	7 1/4"	40	\$13.95
G1241	8"	24	\$25.50
G1242	8"	40	\$31.50

At these prices you can't go wrong!

INCRA JIG



MODEL G1768
Amazing! **ONLY \$28⁵⁰**

**Our warehouse is bursting with tools!
Ask for our free catalog.**

CALL TOLL FREE:

EAST OF THE MISSISSIPPI:

1-800-523-GRRR

(Orders & Catalog Requests Only)

717-326-3806 (Inquiries & Customer Service)

WEST OF THE MISSISSIPPI:

1-800-541-5537

(Orders & Catalog Requests Only)

206-647-0801 (Inquiries & Customer Service)



Mark Duginske uses a dollar bill to gauge the tightness of a joint made with his simple mortise-and-tenon system on p. 46. Cover: Terry Moore finishes a chair he built using a series of jigs (article on p. 40).

Editor Dick Burrows
Art Director Roland Wolf
Associate Editor Sandor Nagyszalanczy
Assistant Editors Jim Boesel, Charley Robinson, Gary Weisenburger
Copy Editor Carolyn Kovachik
Associate Art Director Kathleen Rushton
Editorial Secretary Claire Warner
Contributing Editors Tage Frid, R. Bruce Hoadley, Christian Becksvoort, Michael Dresdner
Consulting Editors George Frank, Richard E. Preiss, Norman Vandal
Methods of Work Jim Richey
Indexer Harriet Hodges

Publisher John Lively
Marketing Manager James P. Chiavelli
Circulation Assistant Brenda Hamilton
Copy/Production Editor Christy McCormick
Public Relations Manager Donna Pierpont
Administrative Secretary Susan M. Clark
Marketing Secretary Sherry Duhigg

National Accounts Managers Don Schroder, Dick West
Senior Sales Coordinator Carole Weckesser
Advertising Coordinator Kathryn Mournian Simonds
Advertising Secretary Jennifer Dunbar
 Tel. (800) 243-7252 Fax. (203) 426-3434

Fine Woodworking is a reader-written magazine. We welcome proposals, manuscripts, photographs and ideas from our readers, amateur or professional. We'll acknowledge all submissions and return those we can't publish. Send your contributions to *Fine Woodworking*, Box 5506, Newtown, Conn. 06470-5506.

Title to the copyrights in the contributions appearing in *Fine Woodworking* magazine remains in the authors, photographers and artists, unless otherwise indicated. They have granted publication rights to *Fine Woodworking*.

Fine Woodworking (ISSN 0361-3453) is published bimonthly, January, March, May, July, September and November, by The Taunton Press, Inc., Newtown, CT 06470. Telephone (203) 426-8171. Second-class postage paid at Newtown, CT 06470, and additional mailing offices. Copyright 1989 by The Taunton Press, Inc. No reproduction without permission of The Taunton Press, Inc. *Fine Woodworking*® is a registered trademark of The Taunton Press, Inc. **Subscription rates:** United States and possessions, \$22 for one year, \$40 for two years; Canada and other countries, \$26 for one year, \$48 for two years (in U.S. dollars, please). Single copy, \$4.95. Single copies outside U.S. and possessions: U.K., £2.95; other countries and possessions, \$5.95. Send to Subscription Dept., The Taunton Press, PO Box 5506, Newtown, CT 06470-5506. Address all correspondence to the appropriate department (Subscription, Editorial, or Advertising), The Taunton Press, 63 South Main Street, PO Box 5506, Newtown, CT 06470-5506. U.S. newsstand distribution by Eastern News Distributors, Inc., 1130 Cleveland Road, Sandusky, OH 44870.

DEPARTMENTS

- 4 **Letters**
- 12 **Methods of Work**
Squaring cabinets; chisel grinding; spiling for making patterns
- 22 **Questions & Answers**
Quieting a noisy planer; a quilting hoop; mildew problems
- 104 **Events**
- 108 **Books**
- 110 **Notes and Comment**
Carlyle Lynch; woodworking grants; Rude Osolnik

ARTICLES

- 40 **Production Chairmaking** by Terry Moore
Jigs and loose tenons simplify angled joinery
- 45 **Designing a chair**
- 46 **Machine-Made Mortises and Tenons** by Mark Duginske
Production techniques for high-quality joinery
- 50 **A Shop-Built Shaper** by Frank Perron, Jr.
Tilting table adds a new angle to panel-raising
- 55 **Sharpening Chisels and Plane Blades** by Bill Stankus
Producing razor-sharp edges with honing guides and waterstones
- 58 **Making a Message Center** by Luca Valentino
Apprentice project develops woodworking skills
- 62 **Student Desks** by John Moore
High school shop class on a roll
- 64 **Making a Writing Desk** by Christian Becksvoort
Customizing a leg-and-apron table with drawers
- 68 **Building a Wooden Hygrometer** by Warren W. Miller
Measuring humidity's dramatic effect on wood
- 70 **Marquetry** by Pierre Ramond
Decorating with a palette of colored woods
- 73 **Gel Stains** by Jim Boesel
Producing even color with less mess
- 75 **A professional's gel techniques** by Gregory D. Johnson
- 76 **Building a Chest-on-Chest** by Carlyle Lynch
A simple method for framing carcasses with solid sides
- 80 **Round-Bottom Planes** by Monroe Robinson
Making tools to fit your hands and needs
- 84 **Tablesaw Safety Devices** by Charley Robinson
A survey of blade guards, hold-downs and push sticks
- 89 **Woodworking Schools**

**In Memory of
Roland Wolf 1946-1989**

Roland Wolf, art director of *Fine Woodworking* and creator of much of the finest artwork we've published in the last seven years, died last December, following an apparent heart attack. We will all miss his extraordinary talent, his good humor and his friendship. In gratitude for all he shared with us and the readers over the years, we dedicate this issue, the last one he worked on, to him.

—The staff of *Fine Woodworking*

Ripping off designs—They say imitation is a form of flattery. Since you published my article on my tambour boxes (*FWW* #75), I have been flattered by a number of amateur woodworkers who have contacted me to let me know how much pleasure they've had imitating my boxes for their loved ones.

I've also been offended by a few would-be-professionals who have tried to pick my brain to put my design into production. These boxes are a big part of my income and fetch an excellent price, based on originality of design and a fine finish. I published those plans to share an idea I was proud of and enjoyed and to be an inspiration to my peers. I didn't expect my idea to be ripped off by small-time operators without the gumption or intelligence to find their own marketable ideas.

—Jamie Russell, Saskatoon, Canada

In defense of Norm Abrams—Having read the article criticizing Norm Abrams and *The New Yankee Workshop* in the November/December issue (*FWW* #79), I feel a rebuttal is definitely in order. Here is a man that has given each of us a lift. I'm tired of turning on the tube and seeing the same old junk on every channel. I'm certain that an awful lot of guys out there like me can't wait until Norm comes on. From the guys I talk to, they all say the same thing—he is a heck of a nice guy. The author of the review, John McAlevey, is right in one way—he is a carpenter, but I didn't see anybody else come on television that does it any better. Until Norm came on, the average wood butcher had nothing.

It's easy to look over someone's shoulder to make corrections. And I feel he was really given a cheap shot. He only has 30 minutes to show you something. Yes, he may slop the glue on fast at times, but he has to work fast. It goes without saying that when you are doing it, the thing will be done slower and with a little more care.

I can't wait for him to come on television. Yes, you could say there are an awful lot of esoteric furniture builders out there who will look down on him. And most of them are thinking about the money he is making with the show and his tapes, and that is possibly what hurts most of these pros. I can't speak for everybody, but I get sick and tired of hearing "put on your safety glasses," "put on your ear muffs," "don't get near the blade" and all the rest of it. Your God-given sense should have told you that to start with. If people are that dumb that they have to be prodded into every little move, then they shouldn't be working wood

to start with. And as far as criticizing him for using power tools for everything, I like it that way. At 57 years old and riddled with arthritis in the hands, I don't find woodworking easy. Power tools help me a lot. Besides, I don't expect to be building furniture at [Colonial] Williamsburg. I can do many things by hand, but come on, it's a real drag. Just look at what these dovetail jigs can do. When I build something, I want to finish it sometime this year. The only thing missing in the show is a big lazy pooch laying on the floor. I love the show, I can almost smell the sawdust from here.

—John McDonnell, Hautborne, N.J.

A Southerner joins with a Yankee—Norm Abrams presents his version of furniture pieces that can be used in the modern home yet reflect something of the past. I have some old cabinets in an old shop that are better looking than the old Shaker pieces on the program, yet I would not put them in my house or present them to a friend. I am a real amateur at woodworking and I can understand the pride of completing a reproduction of fine furniture. This is not what the program is about. The program is about building presentable pieces of furniture in the home workshop. I think he does an outstanding job of presenting the projects. I have learned many things in the five or six programs I have watched. Norm is not trying to give a safety lesson on each program, even though there are imprints on the screen when guards are removed. As a woodworker that has numerous pieces of power equipment, I think it is my responsibility to learn to use the equipment safely. If I don't, then I'm the fool. I notice that Norm has all his fingers, seemingly good eyesight and hearing, plus I do not see any major scars. I think to be a master carpenter and to be Norm's age is a major accomplishment, so he must be a pretty safe guy.

I have not met Norm, but I would like to. I feel that he is a down-to-earth person who enjoys his work and enjoys contributing his knowledge to us—a bunch of amateurs. This is unusual and very nice in this day and time. Another thing—this is the age of power tools. Thanks Norm for helping me build things with them that I didn't have the knowledge to build before.

—Robert D. Walton, Mansfield, La.

Norm a great teacher—Norm is a great teacher. He allows a wonderful, rich pathway to inspire and motivate young people with the "you-can-do-it" attitude. You have to pay your dues at your craft and you have to start somewhere.

The book and video have excellent production values; the projects are interesting and the techniques are wonderful.

John McAlevey's reference to too much use of power tools is ridiculous. Chippendale and Sheraton would have used power equipment for their production work if available at the time. There is an old saying: "Principles are easier on a full belly." The idea we must be "intrinsically pure" and use a chisel/mallet and handsaw is a little naive!

—Nicholas Tyler, Manotick, Ont., Canada

The high cost of custom work—I very much appreciated Douglas Schroeder sharing his experiences in "Handling Large Commissions" (*FWW* #78), but I do find one thing very distress-

**TAUNTON
PUBLICATIONS**

...by fellow enthusiasts

The Taunton Press: Paul Roman, president; Janice A. Roman, vice president; Roger Barnes, design director; Carol Gee, executive secretary. **Accounting:** Wayne Reynolds, controller; Patrick Lamontagne, manager; Jeffrey Sherman, financial analyst; Mary Sullivan, accountant; Carol Diehm, Diana D'Onofrio, Lydia Krikorian, Elaine Yamin. **Books/Videos:** John Kelsey, publisher; Marcie Seigel, administrative secretary; Deborah Canarella, editor; Deborah Fillion, book designer; Paul Bertorelli, Christine Timmons, senior editors; Andrew Schultz, assistant editor; Maria Angione, secretary; Videos: James Hall, associate producer; Thomas Menard, assistant producer; Art

Steven Hunter, Henry Roth, associate art directors; Cathy Cassidy, assistant art director; Iliana Koehler, production assistant; Copy/Production: Ruth Dobseavage, Robert Olah, managers; Pamela Purrone, copy/production editor; Marketing: Jon Miller, director; Andrea Ondak, manager; Philip Allard, senior copywriter; Eileen Hanson, marketing assistant; Barbara Buckalew, marketing secretary. **Corporate Marketing:** Dale Brown, corporate sales director; Diane Patterson, executive secretary. **Data Processing:** Drew Salisbury, manager; Brendan Bowe, Roger Seliga, senior programmers/analysts; Susan Morehouse, programmer trainee; Ellen Wolf, PC coordinator. **Fulfillment & Operations:** Tom Luxeder, director; Jane Torrence, secretary; Circulation: Karen Cheh, coordinator; Mary Ann Colbert, Patricia Williamson, circulation assistants; Customer Service (Subscriber): Patricia Malouf, manager; Nancy Schoch, senior customer service rep; Jane Bojnowski, Diane Hurvul, Barbara Lowe, Joyce McWilliam, Marylou Thompson, Customer Service (Trade): Gloria Carson, supervisor; Christine Cosacchi, coordinator; Peggy LeBlanc, data entry; Lori Moir, telemarketer; Distribution: Danny D'Antonio, manager; Grace Aumuller, David Blasko, Michael Capalbo, Timothy Harrington, Linnea Ingram, Mary Ann Costagliola, Fred Monnes,

Alice Saxton, Robert Weinstein, Purchasing & Facilities: William Schappert, manager; Lois Beck, office-services coordinator; Chuck Hollis, maintenance foreman; Mark Cole, assistant; Christopher Myers, buyer/expediter; Debra Brown, chef/manager; Kathleen Costello, Norma-Jean Taylor, cafeteria assistants; Subscription: Carole Ando, manager; Patricia Aziere, Connie Barczak, Donna Baxter, Patricia Beardsley, Dorothy Dreher, Denise Pascal. **Manufacturing:** Kathleen Davis, director; Austin E. Starbird, prepress manager; Robert Marsala, graphic arts supervisor; Susan Kahn, staff photographer; Peggy Dutton, production manager/books; Philip VanKirk, production manager/magazines; Diane Flanagan, print buyer; Thomas Greco, print production assistant; Ellen Olmsted, production coordinator; Rosemary Pagel, secretary; Chansam Thammavongsa, production assistant; Richard Booth, Deborah Cooper, Mark Coleman, scanner operators; Laurene Jakob, color proofing operator; Dinah George, composition systems manager; Margot Knorr, application publications specialist; Monica Bulson, assistant PC applications specialist; Lisa Carlson, Nancy Knapp, Valerie Lutters, systems operators. **Personnel:** Carol Marotti, manager; Linda Ballerini, personnel assistant; Chris Lincoln, secretary.

ANTIQUE reproduction
furniture HARDWARE



HORTON BRASSES
Nooks Hill Rd., PO Box 120F
Cromwell, CT 06416
203-635-4400
send \$3.00 for a catalog

READER SERVICE NO. 304

MUSICAL KITS

The Early Music Shop

OF NEW ENGLAND now has 3 keyboard kits to choose from

- 4' SPINET
- ITALIAN HARPSICHORD
- FRETTED CLAVICHORD

Send SAE for color leaflet to:-

NIK VON-HEUNE
65a BOYLSTON STREET
BROOKLINE
MASS. 02146.

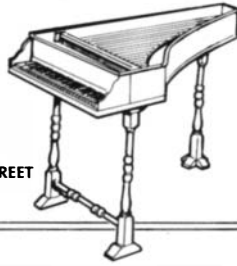

TRUSLOCK SPACING TOOLS

For Safe, Fast Truss Installation



- Re-useable • Accurate • Easy To Use
- Saves Time-Material-Problems



TRUSLOCK
INC.
Route 1, Box 135
Calvert City, KY 42029
1-800-334-9689
502-898-3365

The Better Built
portable saw mill.



The "affordable portable" one man saw mill. Weighs only 45 lbs. Cuts 20" diameter logs into lumber. Minimum 1/8" to maximum 9" thickness.

Write or call for free brochure.

Better Built Corporation

845 Woburn Street, Dept. FW, Wilmington, MA 01887
(508) 657-5636

READER SERVICE NO. 10

AIR POWER CLAMP



Includes cylinder with built-in valve, pressure pad, 8' of air hose and mounting bracket as shown.

\$89.00

Up to 250 lbs. of holding power from your shop air system. Please phone for your free catalog of our complete line of air clamps and accessories.

NEUWAY AIR SYSTEMS 1-800-334-0321
710 So. Third Ave.
Wausau, WI 54401



READER SERVICE NO. 51

GAZEBOS

Included in this delightful book are designs for 55 Gazebos, plus many Bird Feeders, Bird Houses, Arbors and Strobrellas. Construction plans available for all designs. Gazebos and Other Garden Structures \$8.95



Also Available
Backyard Structures
65 Designs \$8.95
Bridges and Cupolas
55 Designs \$8.95

Please include \$1.90 postage and handling for 1st book, .50 for each additional book.



SUN
DESIGNS

173 E. Wisconsin Ave.
P.O. Box 6, Dept. 5
Oconomowoc, WI 53066
(414) 567-4255

MONEY BACK GUARANTEE - MC & VISA ACCEPTED

READER SERVICE NO. 76

SAVE
35%
OFF LIST

BYROM PROFESSIONAL GRADE "WHEN QUALITY COUNTS"

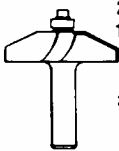

25° PANEL RAISER
1/4 SHANK \$45.00
2" DIA

2-1/2 DIA 1/2 SHK \$55.00
3-1/2 DIA 1/2 SHK \$62.00

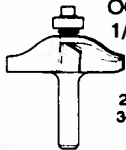

OGEE PANEL RAISER
1/4 SHANK \$45.00
2" DIA

2-1/2 DIA 1/2 SHK \$56.00
3-1/2 DIA 1/2 SHK \$62.00

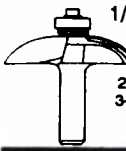

COVE PANEL RAISER
1/4 SHANK \$43.00
2" DIA

2-1/2 DIA 1/2 SHK \$48.00
3-1/2 DIA 1/2 SHK \$62.00

FREUD THIN KERF

LU87 M010 10" X 24TH \$42.00
LU88 M010 10" X 60TH \$48.00
LU98 M010 10" X 80TH \$79.00

TAUNTON PRESS
"BUILDING KITCHEN CABINETS"
\$11.99



REVERSIBLE
RAIL AND STILE
1/4 - 1/2 SHANK

CLASSICAL - \$52.00
STRAIGHT - \$52.00
OGEE - \$67.00



DOOR LIP
1/2 SHANK

\$58.00

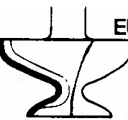

EURO DOOR EDGE
1/2 SHANK

\$35.00



VERTICAL PANEL RAISER
"PROVINCIAL"

1/2 SHANK
\$56.00

CLASSICAL OGEE AND
STRAIGHT AVAILABLE

WOODPECKERS • 8318 MANORFORD DRIVE • PARMA, OHIO 44129
MASTERCARD - VISA 1-800-752-0725 DISCOVER - CHECKS
ORDERS OVER \$25 FREIGHT PREPAID

READER SERVICE NO. 70

Capitalize on Capital Savings!

PORTER-CABLE

100	7/8 HP Router.	\$ 91.00
330	Speed-Bloc™ Sander with Slikit™ pad	54.00
	4" x 30" Slikit™ rolls or #13599 dispenser.	11.95
361	3" x 24" Belt sander (Model 360 with dust collector \$10 extra)	165.00
555	Plate joiner w/case	158.00
	Biscuits, assorted 0, 10, 20 box of 1, 000	25.00
6931	<i>New!</i> Plunge Base	74.00
	For Porter Cable Models 100, 690, 691 and Bosch Models 1601, 1602, 1604, 1606	
7310	<i>New!</i> Laminate Trimmer	83.00
	5.6 amp	
7334	<i>New!</i> Random Orbit Sander	118.00
	5" Slikit™ disks 50/ roll, 100, 120, 150 grit \$12.50/ roll	
9118	Porta-Plane Door-planer: kit with spiral carbide cutter and metal case	185.00
7348	Variable speed orbital bayonet saw (we stock all bayonet blades)	108.00

PANASONIC

EY6205B	12v., 15 min. charge 3/8" Drill, keyless chuck, v.s.r.	199.00
EY6200B	12v., 15 min. charge, 1/2" Drill.	155.00
EY6281B	9.6v., 15 min. charge, 3/8" Drill, kl. ck., v.s.r., electric brake.	165.00
EY571B	9.6v., 1 hr. charge, 3/8" Drill, kl. ck., v.s.r., clutch.	129.00
EY561B	7.2v., 2-speed, 1 hr. charge, 3/8" Drill	109.00
EY503B	2.4 v. Screwdriver, 2-speed, flexible from pistol to straight.	64.00

Free freight on portable tools

Prices subject to change without notice

Texas Residents add 8% state sales tax

C.O.D. add \$3.00

Visa and MasterCard accepted

HOURS Mon-Fri 9-6 Sat 10-5

Serving the industry for over 9 years.

MAKITA

1900BW	3-1/4" Planer Kit	\$ 112.00
2030N	12-1/2" Planer, 6" Jointer w/electric brake, free stand.	1810.00
2711	10" Table Saw w/electric brake. Stand #122251-6 - \$59.00	465.00
3606	<i>New!</i> 1 HP Router	86.00
3612-B	3 HP Plunge Router. (Square Base). #31612BR, same price.	187.00
6071DW	3/8" Cordless Drill Kit, variable speed, reversible, 7.2v.	108.00
6093DW	3/8" Cordless Drill Kit, variable speed, reversible 2-speed, 9.6v.	128.00
6404	3/8" Drill, variable speed reversible 0-2100 rpm	58.00
6510LVR	3/8" Drill, heavy duty variable speed reversible, 0-1050 rpm	75.00
804550	4-3/8" x 4" Finishing Sander, dustless	48.00
LS1440	14" Mitre Saw.	379.00

MILWAUKEE

0314-1	9.6v. 3/8" Cordless Driver Drill w/battery, 1/2 hr. charger and case.	140.00
5936	4" x 24" Belt Sander w/dust collector	196.00
6016	Finishing sander, 1/4 sheet	45.00
6140	4-1/2" Grinder, 10,000 rpm	89.00
6236	2-speed ac-dc Deep Cut Band Saw	259.00
6256	Top Handle Jig Saw	121.00

HITACHI

C8FB	8-1/2" Slide Compound Miter	479.00
C875F	14-1/2" Band Saw	1649.00
CB100F	24-1/2" Band Saw	4400.00

Full line of AMANA bits and blades as well as accessories for our major lines



CAPITAL TOOLS

4840 Gulf Freeway Houston, TX 77023 (713) 923-2425 TEL
(713) 923-4949 FAX Special Orders Welcome 1-800-683-2111

ing. The client paid a total of \$74,000 and Mr. Schroeder said there was no real profit! I am not trying to put down Mr. Schroeder's work; from what I could see in the photographs, the pieces are extremely well made. He goes on to explain costs and reasons, but as someone trying to get his furniture business off the ground, I see a very disturbing trend in the custom, handmade, one-off, etc. furniture market. More and more I see what I consider atrocious prices for furniture that appears to be made for everyday use. We all need to receive a fair price for our work, but \$7,600 for a hall table or \$2,600 for one dining room chair ("Gallery Fair," *FWW* #68) seems a bit out of line.

One of the largest stumbling blocks I have run into is when someone has seen some of my work and automatically thinks it is unaffordable because the piece is "handmade or custom."

Almost all of my work is in the Shaker style: simple, honest, solidly built and what I consider a very good value. I work entirely with hand tools in a very small shop, and my prices are competitive with the finer furniture stores and I offer a better made and finished product; but what is even harder to compete with is the preconceived notion by the public of how much a piece of handmade furniture should sell for.

There will always be people willing to pay astronomical prices for everyday things and there are people who want mass-produced junk for next to nothing, but somewhere there has to be a middle ground. Custom furniture makers can supply a quality product for a fair price.

—Tony Konovaloff, Tahoe Paradise, Cal.

Another limed finish—I enjoyed Michael Dresdner's article on "Creating a Limed Finish" (*FWW* #79), but I'd like to suggest another way to apply the white wash. I've been buying a water-base pigment called Hydrocote White Pickling Stain from the Hydrocote Supply Co. here in Pennsylvania (215-453-8663). It goes on easily, gives you a comfortable working time and wipes smoothly. Best of all, because it's water based, you can rework the material even after it has dried, without resorting to sandpaper or steel wool, simply by using a damp rag. On raw wood it dives into the pores beautifully, and on sealed wood it works indefinitely without "biting into" the finish. I've used it with no compatibility problems with lacquer, varnish and polyurethane, as well as Hydrocote's water-base lacquer.

—Steve Mutek, Kresgeville, Pa.

Hazard of drilling brass or copper—After reading the article on "Metalworking in the Woodshop" by Roger Heitzman (*FWW* #79), I was surprised that no mention was made of the hazard of drilling brass or copper with a twist drill without first grinding a small vertical band on the cutting lips of the twist drill. Neglecting this can cause the drill bit to "grab" into the metal and this can snap a small drill; if a large drill is being used, it can wrench the work free to spin violently on the drill bit.

Drills for rolled brass or cast brass should be so treated. Most of the bronzes, when bored, produce a curled shaving like steel and they can be safely drilled with a bit sharpened in the usual manner.

In this article, mention also should have been made of securely bolting the metal to the drill press table with the work against the drill press column to prevent rotation, or if in a vise, that too should be securely fastened to the drill table.

A good safety precaution—I find that when using the slower speeds for metal, a slackened V-belt allows the belt to slip if the drill bit is overloaded.

Dangers of sawing aluminum—I'd like to back up Roger Heitzman's admonitions about cutting aluminum in *FWW* #79. In 15 years of working with power saws on a daily basis, the closest call I've ever had came from cutting this metal.

I was cutting a fairly heavy 3x3 aluminum angle on my miter box, using one of those four-tooth-plus-raker carbide combination blades. This type of blade has a deep gullet in front of the

raker for good sawdust removal. Well, the angled stock must have gotten caught in one of those gullets because all of a sudden the machine fairly exploded. Not only were several teeth ripped off the blade, but the fence was struck with such impact that the 3/8-in. cap screws bolting it down were ripped out of the bed of the machine, breaking out a good-size chunk of the aluminum bed casting in the process. I don't know where my hands were while all this was going on, but to my astonishment I counted 10 good digits in the aftermath. Any regret I might have had about the loss of \$250 in equipment was overshadowed by my joy at still having a left hand.

The only blade I will now use to cut aluminum is one of those old-fashioned steel plywood-cutting blades with hundreds of little teeth. Most woodcutting blades, with their positive hook and deep gullets, are just too dangerous for the job.

—Scott McBride, Irvington, N.Y.

Help for allergies—This is in reference to the letter by Lane Jonah regarding "allergies and woodworking" (*FWW* #79). I am writing as a medical doctor, a patient with allergies and a woodturner.

The best doctor to see for such a problem is obviously an allergist, who will ask a rather long list of questions to zero in on the type of allergy tests a person will need. Skin testing can readily tell what a person is allergic to.

If one wants to work with something they are allergic to, then one of the best ways to deal with that is to undergo desensitization (allergy shots). With properly directed treatment and precautions, a high percentage of patients can resume woodworking.

A woodworker may not be allergic to pine or maple, but if a person is highly sensitized, a non-specific reaction to any dust particles can result. An ordinary dust mask is not good enough to remove allergens.

—Dr. Vijay K. Dixit, Mt. Clemens, Mich.

Preventing rust on cast iron—In *FWW* #79, Rich Preiss suggests the regular use of carnuba wax to prevent rust on cast-iron tool surfaces. I find no fault with that. If people have trouble finding that wax, though, they might try plain clear paste shoe polish wax, which is available at any supermarket. I've used it for years and it's tough and long wearing.

Incidentally, if your planer ever hesitates while self-feeding, a quick coat of shoe polish applied to the bed—with the machine unplugged of course—will instantly remedy that problem in most cases. The only machine surface I *do not* wax is the drill press table; there I do not want the work to slip.

And you might try waxing the sole of your handplanes. They just glide over the work when waxed. If the supermarket does not have clear shoe polish, get light tan. It's a *hard* polish and *none* of it will show up on your work.

—Tim Hanson, Indianapolis, Ind.

Praise for pine—I really enjoyed the article on pine (*FWW* #79). Of all the furniture I have made and admired in the past, my favorite pieces have been pine. Many furniture makers avoid using pine because it gums up blades, cutters and sandpaper faster than the more popular furniture materials. Mahogany, oak, walnut and cherry have taken the spotlight in the furniture business mainly because these woods are "easy to please." Pine needs to be handled very carefully to obtain a furniture-quality appearance.

Since pine is a fast-growing wood, we should be using it for replacement cabinet material instead of tropical varieties that will soon become hard to obtain due to the deforestation problem we are faced with worldwide.

—Peter B. Rock, Mt. Pleasant, S.C.

No substitute for good joinery—Christian Becksvoort's article on gluing up panels in *FWW* #79, p. 68 is most appropriate reading for all woodworkers. In our efforts to complete work, we sometimes forget some of the fundamental rules that greatly in-

The WALTER A. WOOD Supply Co. Inc.

4509-4517 ROSSVILLE BLVD.

NATIONAL WATS 1-800-476-1415

CHATTANOOGA TENNESSEE 37407

(615) 867-1033

\$\$ SAVE MONEY \$\$

Call Us Before You Buy

CALL TOLL FREE NATION WIDE 1-800-476-1415

We Have A Complete Inventory of the Following Lines



POWERMATIC III

READER SERVICE NO. 67

SAVE 50%

3 Lip Wood Shaper Cutters & Molding Knives Buy Direct From Manufacturer

1 TONGUE	2 GROOVE	3 BEAD QTR. RD.	4 1/4" & 1/2" QTR. RD.	5 1/4" GROOVE (Shaper only)	6 1/2" GROOVE (Shaper Only)	7 1" JOINER
8 DROP LEAF BEAD	9 DROP LEAF COVE	10 BEAD	11 CROWN	12 3 BEAD EDGE	13 GLUE JOINT	14 CLOVER LEAF
15 3/16" COVE & BEAD	16 3/16" BEAD & COVE	17 3 BEAD & BEVEL	18 CABINET DOOR LIP	19 BEAD & BEVEL	20 QTR. RD. & COVE	21 OGEE
22 3 FLUTE - 1/4"	23 3 BEAD - 1/4"	24 90° FLUTE	25 CURVED FLUTE & QTR. RD.	26 5/16" COVE & QTR. RD.	27 3/4" FLUTE	28 3/4" NOSING
29 PANEL CUPRD. DOOR	30 PANEL DOOR-RAIL COOPER	31 TAPER EDGE	32 1/8" RAD. EASED EDGE	33 1/2" RAD. BASE SHOE	3 PCS. 2425 COMPLETE CABINET SET	
34 1/2" FLUTE	35 1/2" NOSING	Shaper Cutter Dimensions: Arbor Hole 1/2", Diameter 2", Height 1"			38 1/8" - 1/4" EASED EDGE	

ORDER FORM MINIMUM ORDER \$21.00

Indicate which item ordered:
 Shaper cutter; or
 Molding Knife

COROB CORPORATION, FW1
53 Westwood Rd., Shrewsbury,
MA 01545

Name _____
(Please print clearly)
Street _____
City _____
State _____ Zip _____

Order by phone:
508-798-8825

METHOD OF PAYMENT:

- Check or Money Order
 MasterCard
 VISA

Card # _____ Exp. Date _____
Signature _____ TOTAL \$ _____

NO.	QTY.	NO.	QTY.	NO.	QTY.
1		14		27	
2		15		28	
3		16		29	
4		17		30	
5		18		31	
6		19		32	
7		20		33	
8		21		34	
9		22		35	
10		23		38	
11		24		ADP10	
12		25		MKH20	
13		26		2425	

Standard Shaper Cutters @ 7.00 ea. = \$ _____
3pc Molding Knife Set @ 7.00 set = \$ _____
Molding Cutter Head MKH20 @ 19.00 ea. = \$ _____
2425 Complete Cabinet Set @ 42.00 ea. = \$ _____
Drill Press/Router Adapter ADP10 @ 9.00 ea. = \$ _____
Handling & Shipping \$ 3.00

Chip Free, Clean Cutting, Extended Life Saw Blades

PARAMOUNT SAW

Full line stocking TOOLING CENTRE for North American and European machinery. State of the art service facility, UPS service, custom tooling, woodworking machinery etc....Call for a free catalog.



XL4000

EXTENDED LIFE SAW BLADES
by FS TOOL CORPORATION

Reduce your tooling costs with the new corrosion resistant, long lasting, premium carbide. Available only in the XL4000 series by FS Tool.

SM6201 for Melamine
diameter 8" kerf: .112"
teeth: 60 **Special Price \$89.95**

SM6251 for Melamine
diameter 10" kerf: .112"
teeth: 80 **Special Price \$104.95**

S23250 For Corian®
diameter 10" kerf: .126"
teeth: 60 **Special Price \$74.95**

INDUSTRIAL DADO SET

54DL08 Dado Set for Melamine
diameter 8" kerf: .13/16"
teeth: 40 **Special Price \$199.95**

Paramount Saw Corp.
15014 Paramount Blvd.
Paramount, CA, 90723
213-633-0606
Fax. Nr. 213-633-0475
Toll Free: California:

Call 1-800-424-SAWS

READER SERVICE NO. 28

crease the beauty and structural integrity of large panel glue-ups.

A well-executed edge joint is without question "more than adequate" for panels. However, I have found that in working alone, the "third hand" is very helpful at times. I routinely use plate joinery as an aid in handling large glue-ups. I do not view this as a compromise; only that "third hand."

One word of caution, though. If you choose to use plates, set the plate joiner depth as deep as possible. I experienced what could be termed as "biscuit draw." After jointing, inserting plates, gluing up and finishing a 32-in. by 96-in., four-board walnut tabletop, my customer noticed "dimples" throughout the surface. What I found were perfect impressions of the "biscuits" along each joint. I can only surmise that the depth of the cutter was too shallow and that the extra amount of glue at each plate pulled the surface toward the plate.

—Randall Grace, Franklin, Tenn.

A call for more basic information—Every issue's crop of "Letters" must bring you new insights to the diversity and temperament of your readership.

In *FWW* #79, we find a gentleman who feels *FWW* should devote more space to working with plastics and mica. Fair enough. But he wants you to do so at the expense of another story on machine adjustment or, perhaps, some basic joinery.

Hear a voice from another precinct. You can never publish too many stories on basic woodworking operations and tools. Each one I have read contains some nugget of new information that broadens my knowledge of the subject. Sometimes the new information contradicts the old, other times it explains and amplifies it. Inquiring minds welcome that kind of stimulation.

By all means, give the gentleman a piece on plastics or mica. But don't think twice about another explanation of dovetailing, edge

jointing or tuning up a bandsaw. Somebody out there has a new or different wrinkle on these matters and I want to read about it.

—Robert W. Smith, Jr., Slidell, La.

Ban letters on ecological issues—Although I am not a proponent of the deforestation of exotic lands or the harvesting of ivory, I must state that I feel space in your "Letters" column could be better used than as a forum for protest. Ecological issues, important as they are, are not the reason I take *FWW*.

I am sure the readership knows fully well about the travesty and rape of our planet. Those that use these materials will continue to do so regardless of "angry letters."

Let's remember that materials used by the trade are a small percentage of what is used by others. —L.R. Pastukiw, Eldson, Tenn.

How far can ban mentality go?—It is unfortunate that the "ban" mentality has now hit the "Letters" column. Following

Erratum

In *FWW* #80, we ran a letter from Lee Valley Tools Ltd., in which the company President Leonard Lee tried to correct an error that had appeared in an ad for the company's Stone Pond sharpening aid. Unfortunately, because of an editing error, the letter was printed incorrectly. We apologize for the error and would like to clear the record concerning the flatness of the tempered glass lapping plate. The ad indicated the flatness as plus or minus .001 in. It should have read .010 in. For further information, contact Mark Williams at Lee Valley Tools Ltd., 1080 Morrison Drive, Ottawa, Ont., Canada K2H 8K7; (613) 596-0350.

FORSTNER BIT AMAZING OFFER!

Quality, imported Forstner Bits make glass smooth, flat bottom, clean holes, even through veneer, knots and end grain, in any direction. Indispensable for furniture making. Will bore any arc of a circle, make pocket and blind holes and even make overlapping holes for mortising.

7-pc Set
1/4" to 1" in wood case



ONLY \$34⁹⁹
Ship/Handl \$3.00

ITEM NO. #10-1325

- Precision Ground, Quality Bits
- Machined from High-Carbon Steel
- Hardened to HRC 50-52
- Reusable Moulded Covers Protect Rims



COMPLETE 16-pc Set
1/4" to 2 1/8" in wood case

ONLY \$89⁹⁹
Ship/Handl \$5.00

ITEM NO. #10-1330

- Wood Storage Box Included
- 3/8" shanks

For a **FREE** price list of individual Forstner Bits, and other wood working tools, send your name and address to: **Dollar Trading Corp.**
PO Box 964
Ridgefield, CT 06877

3" FORSTNER BIT
1/2" SHANK



ONLY \$34⁹⁹
Ship/Handl \$3.00

ITEM NO. #10-1322

30-DAY MONEY-BACK GUARANTEE

CALL TOLL FREE: 800-447-7770 • VISA/AMEX/MC

From Canada: 616-957-5900

or write: **DOLLAR TRADING CORP. DEPT FW 30**

PO Box 8433 Grand Rapids MI 49512

Michigan and Connecticut buyers please add sales tax.

WILLIAMS
TOOL
& HARDWARE SUPPLY

Call For Free Catalog!
800-338-6668
Freight Paid Most Tools
Serving Woodworkers since 1946
2017 White Settlement Road
Fort Worth, Texas 76107

Delta

34-444	10" Contractors Saw	call
34-445	10" Contractors W/Unifence	call
34-782	3HP Unisaw W/Unifence	call
34-763	3HP Unisaw W/Jetlock Fence	call
34-781	1-1/2HP Unisaw W/Unifence	call
34-761	1-1/2HP Unisaw W/Jetlock Fence	call
28-283	3/4HP Band Saw W/Enclosed Base	call
28-245	1/2HP Band Saw W/Enclosed Base	call
33-990	10" Radial Arm Saw	call
37-350	8" Jointer DJ20	call
37-154	6" Jointer DJ15	call
17-900	16" Drill Press	call
43-375	HD 2 Speed Shaper	call
32-100	Plate Biscuit Joiner	call
22-661	13" Thickness Planer	call
33-050	Sawbuck	call
40-601	18" Electronic Scroll Saw	call

ELU

3338	2-1/4HP Electronic Plunge Router	\$259
3304	1HP Electronic Plunge Router	180
4024	3X21 Electronic Belt Sander	206
3375	Universal Planer	195
3380	Jointer/Spliner	329

Porter Cable

330	Speed Bloc Sander	\$54
690	1-1/2HP Router	128
100	7/8HP Router	93
691	1-1/2HP D-Handle Router	124
555	Plate Joiner	158
7548	VS Bayonet Saw Top Handle Orbital	159

Ryobi

AP10	10" Surface Planer	\$339
RE600	3HP Electronic Router	189
BE321	3X21 Electronic Belt Sander	123
JP155	6" Bench Motorized Jointer	328

Bosch

1609K	Router Kit-Installers 4 in 1	\$159
1604	1-3/4HP Router	119
1611	3HP Plunge Router	193
1581VS	Orbital Jig Saw VS Top Handle	127
1273DVS	4X24 VS Belt Sander	185

Hitachi

TR12	3HP Plunge Router Kit	\$166
C15FB	15" Miter Saw W/Accessories	389
C8FB	8" Compound Miter Saw	465
CB75F	Resaw Band Saw	1568
F1000A	12" Jointer/Planer Combination	1499

READER SERVICE NO. 69

Lie-Nielsen TOOLWORKS INC.

Rt. 1 Warren, Maine 04864 (207) 273 2520
NEW Low Angle Block Plane \$75.
Free brochure of Heirloom Quality Tools.



READER SERVICE NO. 57

WHITECHAPEL BRASSES LTD. FINEST HARDWARE



P.O. BOX 136 • 3650 W. HIGHWAY 22
WILSON, WYOMING 83014
(307) 739-9478

LOCKS • HANDLES • DRAWN HINGES • ETC

PROMPT
SERVICE

CATALOG
\$2.00

READER SERVICE NO. 162

NEW! CONVEYOR DRIVE DRUM SANDER

with Infinitely Variable Power Feed!



At last! A complete power-feed Drum Sander at an affordable price! Choose from 26" and 38" models. SAVES TIME... IMPROVES RESULTS.

Use this high-tolerance machine for light dimensioning as well as the finest finish work. Now you can add new beauty to each wood-working project...saves hours of tedious hand sanding! In a matter of seconds you can produce a satin-smooth finish impossible to duplicate with hand methods or hand-held power sanders...no more low spots, waves or cross-grain marks!



Call Toll Free 1(800)538-4200, Ext. DS30

YES! Please rush my FREE INFORMATION KIT and details on your 30-Day Free Trial Guarantee.

Woodmaster Tools Dept. DS30
2908 Oak, Kansas City, MO 64108

NAME _____

ADDRESS _____

CITY _____ STATE _____ ZIP _____

READER SERVICE NO. 26

**IF YOU THINK OUR NEW
BAR CLAMP LOOKS GREAT,
WAIT UNTIL YOU GET
YOUR HANDS ON IT.**



Pick up the new QUICK-GRIP™ Bar Clamp. Squeeze the pistol grip handle to tighten clamping pressure. One finger on the quick-release trigger unlocks the clamp.

You've only used one hand.

The revolutionary pistol-grip mechanism puts control of clamping pressure in the palm of your hand. You can work faster, with more precision. Positive locking action holds work tight. Quick-release trigger lets go in a snap. High-tech resin construction is

strong yet lightweight. Instantly adjustable clamping pressure. Large, pliable pads won't mar work. Available in five sizes - 6"/150mm, 12"/300mm, 18"/455mm, 24"/605mm, 36"/910mm.

Get your hand on the new QUICK-GRIP Bar Clamp wherever quality tools are sold. Yes, it looks revolutionary. And this time, looks aren't deceiving.

QUICK-GRIP™
A UNIT OF AMERICAN TOOL COMPANIES, INC.

©1989 AMERICAN TOOL COMPANIES, INC.
U.S. AND FOREIGN PATENTS PENDING.

READER SERVICE NO. 83

the "logic" of the letter to ban ivory from the pages of *FWW*, it would follow suit to ban scrimshaw, mother-of-pearl inlay, leather work and actually most of the woods we now use. We then could use synthetic materials which are highly energy intensive, thus wasting our non-renewable resources and creating infinitely more pollution.

Hiding ivory objects from view will not stop the poaching that threatens the elephant herds. We need to encourage our legislators to pressure foreign governments to increase their anti-poaching efforts. Only after the elephant population can be returned fully to legitimate game management can we expect a steady supply of ivory and the healthiest possible elephant herds. This generally holds true for any type of natural resource, flora and fauna.

I applaud *FWW* for the wide-ranging coverage of the many facets of woodworking. *—Larry Hokenson, Isanti, Minn.*

Hog-tusk inlay—In recent issues, you have had several readers suggest that the use of ivory should be banned. I'd like to point out that ivory does not have to come from endangered species such as elephants and whales. Ivory is, by definition, dentine. An excellent source for this material is the tusk of the domestic hog. These tusks are often 2½ in. long and an inch broad at the base. They are readily available from rock shops that specialize in materials for lapidary work. The tusks also don't cost a month's salary. The last ones I bought were about 25 cents each.

You can also assemble larger inlays from the hog tusks by cementing smaller slices of the material together with the clear epoxy sold by the rock shops for setting gem stones. I use a material called epoxy 330, which makes an invisible joint. It seems to me that as long as we have sausage and bacon for

breakfast and pork chops for dinner, we will have a continuous supply of material for fine inlays.

—James L. Ennenga, Omaha, Neb.

A perfect piece of cabinetry—We were *very* impressed by the back cover of your November/December issue. We always check the back cover first anyway—it's one of the most interesting pages in the magazine!

"Shall We Dance" is the most perfect piece of cabinetry we've seen. Closed, it sways alluringly to the right, ready to swoop around the floor; open, it has just as much sense of movement. We heard the lighthearted music of a '30s Astaire film as we looked at the pictures. Hank Hölzer has even captured the humor of Astaire in the bow tie pulls.

Thank you for a moment of aesthetic pleasure and nostalgia. We agree with the Art Deco furniture makers that it is an art to make furniture and that the people who do it are sculpting space in creating finely detailed, beautiful forms.

—Dan Everett and Jocelyn Paine, Anchorage, Alaska

About your safety:

Working wood is inherently dangerous. Using hand or power tools improperly or neglecting standard safety practices can lead to permanent injury or death. So don't try to perform operations you learn about here (or elsewhere) *until you're certain that they are safe for you and your shop situation.* We want you to enjoy your craft and to find satisfaction in the doing, as well as in the finished work. So please keep safety foremost in your mind whenever you're in the shop.

—John Lively, publisher



BLUME SUPPLY, INC.
3316 South Blvd. • Charlotte, NC 28209
704-523-7811 or 1-800-288-9200

STEP UP TO . . .

POWERMATIC III

YOU DESERVE THE BEST!



\$1275

#26 SHAPER 2 HP



\$1450

#66 10" SAW 2 HP
W/50" VEGA FENCE



\$4195

#180 18" PLANER
W/KNIFE GRINDER



\$1350

#60 8" JOINTER

NEW! **RB-25 SINGLE PHASE 10 H.P. WIDE BELT SANDER \$7299**

CALL FOR OUR LOW PRICES ON OTHER POWERMATIC MACHINES NOT LISTED, AS WELL AS PRICES ON THE NEW ARTISANS LINE OF MACHINERY.

Air Handling Systems

YOUR BEST DUST COLLECTION SOURCE...

COMPLETE LINE OF ROUND PIPE FITTINGS IN STOCK FOR FAST DELIVERY

FOR CATALOG & PRICES
CALL 1-800-FOR-DUCT
Or in Connecticut 203-336-0533

- Buy direct from manufacturer and save.
- Install yourself and save more.
- We supply you with all the materials.
- All you have to do is put it together.



Manufacturers Service Co., Inc.
358 Bishop Ave. Dept. F1
Bridgeport, CT 06610



READER SERVICE NO. 84

Popular, Pocket-size
MINI-LIGNO
\$110
Only

Incl. Case, Batteries and Pins for 3/16" and 7/16" Measuring Depth.

Also available as:
Mini-E: Range 6-36%
Mini-C with external probe.

Everybody Knows

that the moisture content of wood is crucial. Moisture related defects such as surface checks, warpage, cracks, loose joints, foggy finishes, etc., can ruin the best piece ever built.

Everybody Knows

moisture defects are irreversible. Therefore don't waste money and time on wet wood. Use a moisture meter to be sure you work only with dry wood.

Ask for free brochure on moisture meters (range 4-30%, 4-60%) and accessories to monitor air or kiln drying.



Wood Moisture Meter
from Lignomat USA

P.O. Box 30145
Portland, OR 97230
Tel: 800-227-2105 503-257-8957

READER SERVICE NO. 84



SmartLevel®

the new, electronic hand tool that accurately measures every angle, not just level and plumb

Your old bubble level is a thing of the past, because now you can own SmartLevel®. More than just a level, SmartLevel is a digital inclinometer that electronically measures every angle easily, reliably and accurately—every time!

With the push of a button, SmartLevel measures and displays:

- Level or Plumb
- Rise Over Foot of Run (Pitch)
- Degree of Slope
- Percent of Slope

So you can quickly measure roof pitch; drainage, landscape or deck slopes; stairway rise; level and plumb. Plus, because SmartLevel displays direct measurements, you don't have to do any other calculations to figure pitch or slope.

SmartLevel helps reduce costly re-work

SmartLevel helps you avoid re-work because—unlike a bubble level—you can always be sure your SmartLevel measures true. Just press the "Reset" button and your SmartLevel is easily recalibrated to reliable accuracy.



Just press the Mode button to directly measure rise over run (pitch) Δ, degree of slope °, percent of slope %, or level and plumb with, if you prefer, a simulated bubble (∩). Arrow shows direction to true level/plumb.

Plus, SmartLevel provides an exact digital display of the measurements you make, so there's no guessing. The display



One sensor module will fit interchangeably into any of the 2-, 4-, & 6-ft. rails. The sensor module can also be used alone as a torpedo level.



SmartLevel was designed by a team of engineers and experienced carpenters to make it easy to use and to last a long time.

can be read from as far away as 10 feet, overhead or below-shoulder level, in bright or dim light. The display even "flips over" so you can still read it when it's upside-down.

Made of sturdy, high-quality materials for durability

The heart and brains of SmartLevel is a rugged, solid-state sensor sealed inside a weather-resistant polycarbonate module. You can use it alone as a torpedo level or lock it quickly into the hand-holds in our 2-, 4-, or 6-foot rails.

The hand-crafted rails are made of strong, aircraft-grade aluminum, through-bolted to solid teak centers that absorb shock and resist warping. The triangular shape provides a low center of gravity to make SmartLevel more stable than I-beam levels.

100% guaranteed

Every SmartLevel is backed by a 100% satisfaction guarantee. If for any reason you are not happy with your SmartLevel, you may return it within 30 days for a full refund. But we're sure you'll want to keep it—and it's backed by a one-year warranty against defects in materials and workmanship.

So order yours today. Then you can stop second-guessing your old bubble level or replacing it year after year. Because you'll have SmartLevel—the most accurate, versatile and durable "carpenter's level" you'll ever own.

Order by mail, or phone toll-free 1-800-SMARTLEVEL

1-800 762-7853

Please mention Code COFW
Mon.-Fri.: 7:30 AM-5 PM Pacific Time



In some areas, SmartLevel is available at select stores. Call Wedge Innovations for the name of the authorized SmartLevel dealer nearest you.

SmartLevel Order Form

Mail to: Wedge Innovations, 532 Mercury Dr., Sunnyvale, CA 94086

Description	Item #	Qty.	Price	Total
Sensor Module (fits in any rail)	SM		\$89.95	
2 ft. Rail (without module)	TR2		\$30.00	
4 ft. Rail (without module)	TR4		\$60.00	
6 ft. Rail (without module)	TR6		\$90.00	

Sub total: _____

Calif. residents add local sales tax: _____

Shipping (add \$6.50 for each rail ordered; Alaska & Hawaii \$10 per rail): _____ *

Total: _____

Payment method: Check VISA MasterCard
Card #: _____ Exp. Date: _____

Authorized card signature _____

Ship to: (No P.O. boxes please.)
Name _____

Address _____

City/State/Zip _____

Daytime phone (_____) _____

*Mail orders, please allow 3 weeks for delivery. For faster service, credit card orders may be placed by phone. For overnight or second-day delivery service, call Wedge Innovations for delivery charge quote. Foreign orders please write, or FAX to 1-408-739-3353. COFW

Calculating the radius of an arc

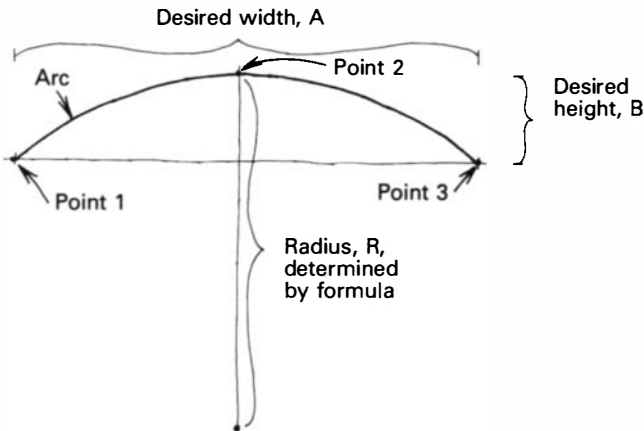

Quite often, when designing a curved cabinet or tabletop, you need to determine the radius of an arc that will give you a specific amount of convexity (height of arc) and also fit within a specified width. Here's a formula for calculating the radius of an arc that must pass through three predetermined points. With it you can find the radius (R) from the desired width (A) and height (B) as defined by the three points, shown above. The formula is:

$$\frac{\left(\frac{A}{2}\right)^2 + B^2}{2B} = R$$

For example, to find the radius of an arc that is 12 in. wide and 2 in. high, let A = 12 and B = 2. Then:

$$R = \frac{\left(\frac{12}{2}\right)^2 + 2^2}{2 \times 2}$$

$$R = \frac{(36 + 4)}{4}$$

Finally, R = 10. The arc's radius is 10 in.

—Barrie Grabam, Arundel, Que., Canada

Squaring cabinets during glue-up

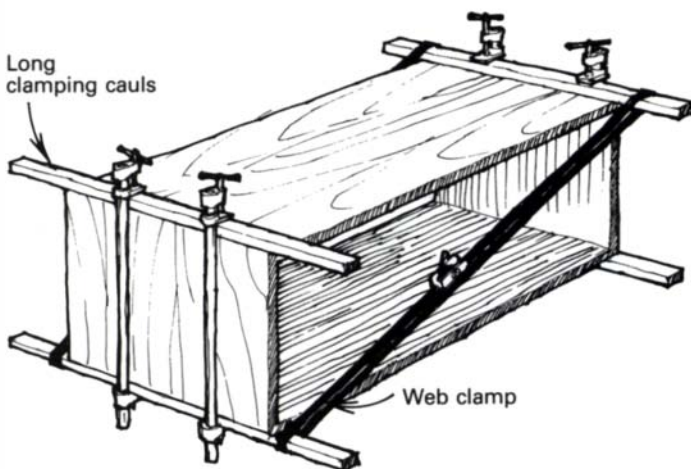

To square a cabinet, I use a pair of web clamps in conjunction with extra-long glue cauls. During glue-up, I determine in which direction the cabinet is out of square. Then, a web clamp is placed across the long diagonal, one on each side,

and they are tightened. The cabinet is square when the diagonals are equal in length. This procedure is easy and exact, and best of all, these clamps can't slip and fall off when you finally get the cabinet square.

—Mark G. Carls, Juneau, Alaska

Quick tip: To keep tiny drill bits from breaking, slip a sponge-rubber ball, like the ones children use to play jacks, over the bit before you use it. The point of the bit should just protrude from the ball. The ball gives the bit extra support and compresses as the bit goes into the stock.

—Donald F. Kinnaman, Phoenix, Ariz.

Lawn mower height adjusters on tool stands

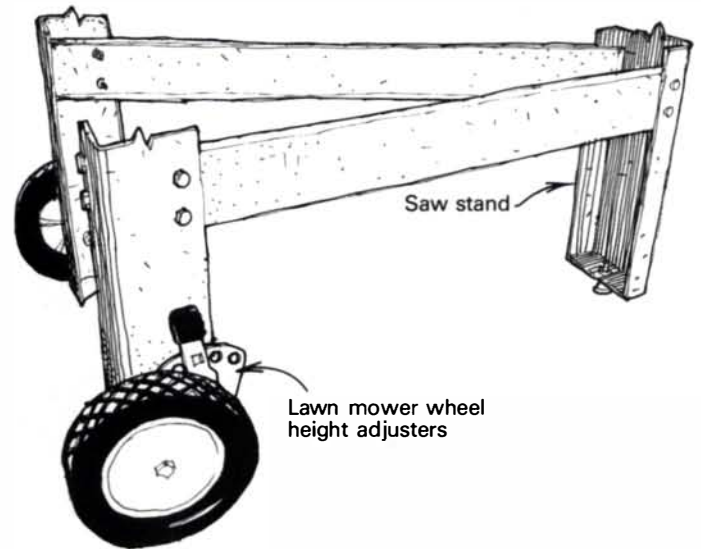

By attaching lawn mower wheel height adjusters to your tool stands, you can add portability without disfiguring the equipment. In my case, I fitted the height adjusters (Arnold model HA700) along with 6-in. lawn mower wheels to the two front legs of my 140-lb. scroll-saw stand. The adjusters and wheels are readily available at small-engine repair shops and simple to attach by following the manufacturer's instructions on the back of the package. Just be sure that the stand will sit on the floor when the wheels are all the way up.

—Donald G. Hulsey, Tucson, Ariz.

Quick tip: Sand the small openings in a grill with a detooled sabersaw blade that has sandpaper strips glued to its sides. Using fine sandpaper for the strips will reduce cross-grain sanding marks.

—David E. Evenson, Cumberland, Wisc.

Fitting legs to a turned pedestal

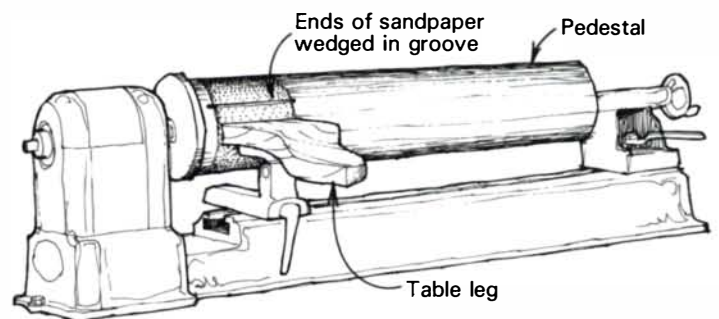

Recently I built a pedestal table with four legs that were attached with hanger bolts secured by nuts inside the hollow pedestal. The

WORKBENCH TOOL CO.

2833 Perry St., Madison, WI 53713



Powermatic Specials

#66	3 hp 1 phase w/ #50 Beisemeyer fence.....	\$1,599.00
NEW★	5 hp, 1 phase saw w/ #50 Beisemeyer fence..	1,723.00
#26	Shaper, 3 hp, 1 phase.....	1,475.00
#100	12" Planer, 3 hp, 1 phase.....	2,106.00
#60	8" Jointer 1½ hp, 1 phase.....	1,375.00
#180	18" Planer 5 hp, 1 phase.....	4,395.00
#1150A	15" V.S. Drill Press ¾ hp, 1 phase.....	1,300.00
#225	24" Planer, 15 hp, 3 phase.....	10,260.00

FOB MADISON OR MC MINNVILLE

POWERMATIC

1-800-533-9282
608-273-0148

READER SERVICE NO. 20

DELMHORST MODEL J-88 Pocket-size Wood Moisture Tester

LED display-type meter indicates ten ranges of wood moisture content between 6 and 20 percent. Ideal for a woodworking shop or serious craftsman.



Limited 3-Year Warranty.
Shipped complete with carrying case, batteries and pins.

ORDER ONE TODAY!
1-800-222-0638
NJ-201-334-2557



DELMHORST
Instrument Company

P.O. Box 68, Dept. 908
Towaco, NJ 07082

READER SERVICE NO. 77

WOODWORKER'S CATALOG



There are over 4,000 money-saving reasons why woodworkers rely on Constantine.

4,000 woodwork items for fine wood-working and finest results. Everything important to people who like to Build-Restore-Repair-Refinish — and like to save money doing it. Cabinet or furniture wood? Choose from over 200 sizes and kinds. Beat up surface to cover? Choose from 150 richly-grained veneers. Plus 500 plans . . . cabinet hardware . . . 96 How-To Books . . . 118 carving tools and chisels . . . 76 inlay designs . . . and lots more for One-Stop, Right-Price Shopping without leaving home!

116 Page Catalog—Only \$1.00

CONSTANTINE Est. 1812
2065A Eastchester Road, Bronx, NY 10461

READER SERVICE NO. 152

Study the Classics.

In a comprehensive two-year program designed to teach the techniques of quality custom furniture construction. For further information contact Lonnie Bird at

1-614-245-5353



WOODWORKING
TECHNOLOGY
UNIVERSITY OF
RIO GRANDE
Rio Grande, OH 45674

QUALITY UNFINISHED DOORS AND DRAWER FRONTS



TRADITIONAL
AND
CONTEMPORARY
STYLING

- Red Oak
- Cherry
- Soft Maple
- White Birch

Custom Orders From
2 To 2000

Send \$1.00 For Our Brochure.

MICHAEL FARR
CUSTOM WOODWORKING, INC.

R. D. #2, Box 150, Millville, PA 17846 • (717) 458-4295

READER SERVICE NO. 157

1/2" Shank Carbide-Tipped Router Bits Moulding Plane Profiles

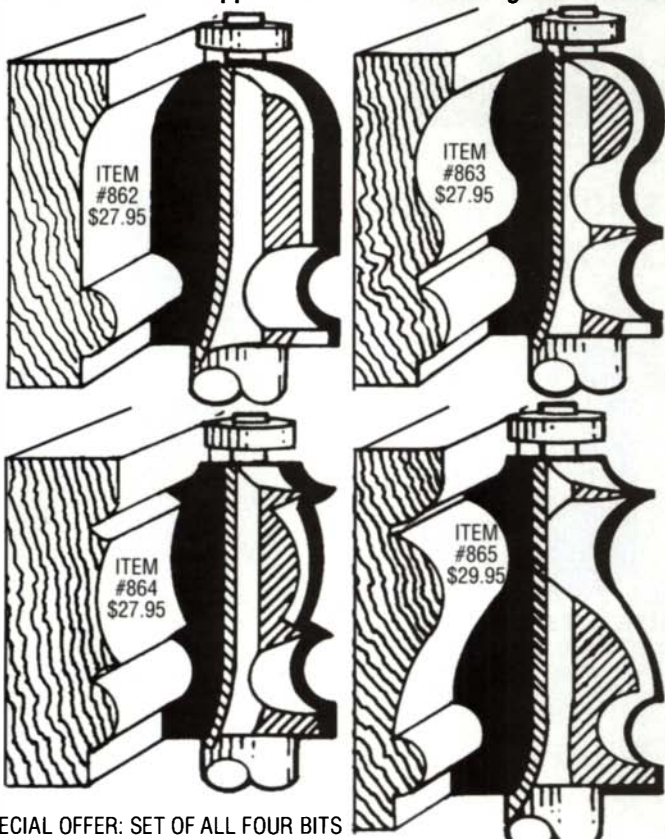

SPECIAL OFFER: SET OF ALL FOUR BITS \$99.95 ORDER ITEM #866. Set of four quickly produce classic traditional mouldings. Bits are shown Full Size - 2 Flute Carbide Tipped. Order by VISA/ MasterCard, 7 Day / 24 Hour Service, Call 1-800-533-9298 or send check to: MLCS Ltd., P.O. Box 4053FD, Rydal, PA 19046

READER SERVICE NO. 75

CREATE
PERFECT
MULTIPLE MORTISE
& TENON JOINTS
EASILY!

NEW

Introducing the World's First Multiple Mortise and Tenon Jig



At last, you can create one of the most challenging - but most useful - joints in woodworking with just a simple plunge router. The fully adjustable Leigh Multiple Mortise and Tenon Jig lets you cut perfect multiple mortise and tenon joints in any size, or any layout you want, in virtually any size stock.

The Leigh Multiple Mortise and Tenon Jig is available either as an attachment to the Leigh Dovetail Jig or as a separate, stand alone jig.

Call for FREE Brochure!

Discover today how to add the beauty and strength of multiple mortise and tenon joints to your projects. Call toll-free 1-800-663-8932 and ask for our FREE MMT Brochure. In Canada 604-464-2700, collect.

LEIGH

LEIGH INDUSTRIES LTD.
P.O. Box 357 Port Coquitlam BC V3C 4K6

problem I faced was machining a concave surface on the joint surfaces of the legs so they would mate with the cylindrical pedestal. A simple machine setup did not seem obvious and carving the leg profile with hand tools seemed like an all-day job. Thinking that a drum sander the same size as the pedestal would be just the thing, I happened to look over at the pedestal still on the lathe and things clicked. I decided to wrap sandpaper around the pedestal and use it as a sander.

I selected a 6-in.-wide E-weight paper belt to do the work. To hold the paper in place on the pedestal, I routed a groove $\frac{1}{8}$ in. wide and $\frac{3}{8}$ in. deep where one of the legs would be attached. I then tucked the ends of the sandpaper into the slot and secured them with a wooden wedge.

To sand the legs, I simply propped the leg on the tool rest, pushed the surface into the rotating pedestal and frequently checked the progress of the sanding. I was able to make small adjustments in the angle and pressure to keep the profile accurate. The profile cut by this method is off by the thickness of the sandpaper. However, the fit can be improved quickly by scraping the middle of the surface with a curved scraper.

The best thing about this method is the thought that someday someone will repair or refinish the table. They will take off the legs and ask "What in the world is that $\frac{1}{8}$ -in.-wide groove for?"

—Frank D. Hart, Plainfield, Ind.

Quick tip: If airborne sawdust is a problem when working on-site or in a shop not equipped with a dust collection system, here's a solution. Drop a furnace filter on the back of a portable room fan, the kind that's about 22 in. square and sits on the floor. The suction holds the filter in place and clears the air in minutes.

—Ed Muldoon, Mt. Prospect, Ill.

Worry-free chisel grinding

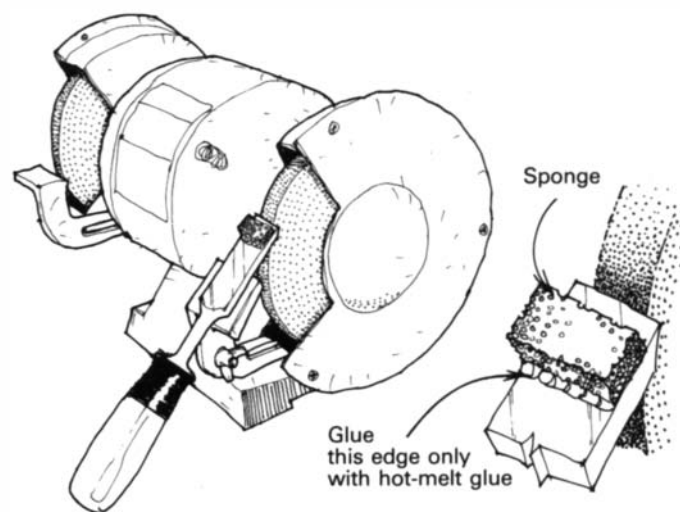

When grinding plane irons or chisels, I first attach a small piece of dried sponge near the cutting edge with hot-melt glue. Then, before grinding, I dip the sponge in water until it is well soaked. Because the wet sponge keeps the edge cool, I can grind away in a continuous operation without worrying about me or the iron losing our tempers.

—Don Klimesb, Brownstown, Pa.

Reverse images for animal carvers

I discovered a simple solution to a perplexing problem woodcarvers often face. Like other carvers of birds and animals, I use pictures to ensure I get all the details right. But a picture

BRIDGEWOOD®

WOODWORKING MACHINERY

YOU BUY DIRECT
NO MIDDLEMAN

PRICES F.O.B., YORK, PA
SUBJECT TO CHANGE
WITHOUT NOTICE

Get Your **MONEY'S WORTH** in Professional Quality Woodworking Machinery! Get **BRIDGEWOOD!**



BW-2S SHAPER \$895.
Large 20" x 24 $\frac{3}{8}$ " table. Dovetail miter gauge slot. $\frac{1}{2}$ " and $\frac{3}{4}$ " interchangeable spindles. 2 HP motor, forward/reverse switch. Seven other model sizes available.



PLANER \$2,495.
Planes 16" wide by 7" thick. Exclusive stock feed disconnect. 3 HP US Motor, variable feed rate. Other models from 12" to 24" wide.



BWJ-872 JOINTER \$1,795.
Planes 8" wide and up to $\frac{1}{2}$ " deep. Four knife cutter head. 2 HP US motor. Other models from 6" to 16" wide.



PBS-740 BANDSAW \$2,495.
Designed and made in Europe. 28" throat opening. 19 $\frac{1}{2}$ " depth. Table tilts 45°. Miter gauge slot. Rip fence. Other models from 14" to 20" available.

There are over 60 outstanding, professional woodworking machinery values in our New, 52-PAGE BRIDGEWOOD MACHINERY CATALOG. To get your copy, send \$1.00 to: WILKE MACHINERY COMPANY 3230 Susquehanna Trail, North, York, PA 17402. VISIT OUR NEW SHOWPLACE 1 block west of Exit 11, Interstate 83 north of York, PA.

WILKE MACHINERY COMPANY

One of America's Most Respected Names in Woodworking Machinery.

OFFICES AND SHOWROOM:
3230 Susquehanna Trail, North, York, PA 17402
Phone: (717) 764-5000 Fax: (717) 764-3778
IN CANADA: Brettwood Machinery Works, Ltd. Madoc, Ontario 613-373-4920

READER SERVICE NO. 163

SAVE \$62

**STOP "SCRATCHY" SAW CUTS
and eliminate jointing and sanding.**

Our Best Seller The 10" x 40T

Only \$94 (List Price \$156)

(other sizes available - see chart)

SALE PRICES!!

NO-CHIP BLADES & DAOO SETS for
MELAMINE & OAK/BIRCH VENEER
VERT. & HORIZ. PANL. SCOR. SETS
RADIAL & CHOP SAW
INQUIRE!!



**The One Blade That Leaves A
SMOOTH-AS-SANDED SURFACE!!!**

(and lasts 10 to 20 sharpenings)

CALL 1 (800) 733-7111

IN NEW JERSEY (201) 473-5236. BUSINESS OPEN ACCT. CHECKS OR CREDIT CARD

- All purpose blade with 40 teeth and 1/8" or 3/32" thin kerf.
- Rips and Crosscuts 1" - 2" hard and soft woods.
- Cuts ply-veneers oak/birch with NO BOTTOM SPLINTER, (with blade set low and moderate feed rates).
- NO NEED TO CUT 1/16" OVERSIZE as JOINTING AND SANDING are USUALLY ELIMINATED (on a good machine).

40 years of fine American Saw Blade making & sharpening.

Dealer Inquiries Welcome

FORREST

MANUFACTURING COMPANY, INC.
461 River Road
Clifton, NJ 07014 1 (800) 733-7111

WE RECOMMEND OUR FACTORY SHARPENING (all makes of blades)
(600 grit microscoped)
2-3 DAYS ON THESE AND ALL MAKES OF CARBIDE TIP SAWS.
SHIP UPS.
10 X 40T \$15.00, 60T \$17.75. ADD RETURN UPS \$3 OR 2ND DAY AIR \$5.

FORREST

READER SERVICE NO. 164

WOODWORKER II (for table saws)

	List	SALE
14" x 40T x 1"	\$215	\$129
14" x 30T x 1"	195	117
12" x 40T x 1" 5/8" Bushing	183	109
12" x 30T x 1" add \$3.25	162	97
10" x 40T 1/8" or 3/32"	156	94
30T 1/8" or 3/32"	135	81
9" x 40T	146	88
30T	125	75
8" x 40T 3/32"	136	82
30T 3/32"	115	69
7-1/4" x 30T 3/32"	112	49
7" x 30T 3/32"	112	49

5/8" holes, boring thru 1-1/4" add \$7.50
Larger at Time Basis Shipping \$3.50

FOR BETTER CUTS on all brands of blades, use our large 1/8" DAMPENERS-STIFFENERS against one side.

- Parallel and flat to .001 **6" ...\$25**
- Stop vibration, flutter, cutting noise and blade ring **5"24**
- Tryable and returnable for full cash refund **4"21**

FREE dampener or \$10 off with any 2nd blade
FULL RANGE OF OTHER INDUSTRIAL SIZES

BUSINESS OPEN ACCOUNT



TO ORDER BY MAIL, clip ad, circle choices and enclose payment.

Specify Dept. FW when ordering.

PHONE TOLL FREE! 1 (800) 733-7111

To inquire Or Order in NJ: (201) 473-5236

SATISFACTION GUARANTEED OR FULL CASH REFUND.

Here's your Help!

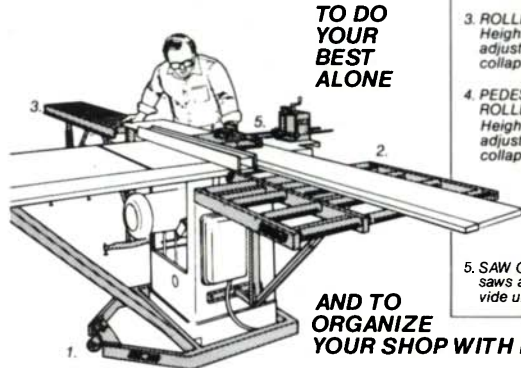

TO DO YOUR BEST ALONE

AND TO ORGANIZE YOUR SHOP WITH EASE

MOBILE BASES

1. Models available for any machine

WORK SUPPORTS

2. OUTFEED ROLLERS fold neatly to save space



3. ROLLERTABLE Height adjustable, collapsible

4. PEDESTAL ROLLER Height adjustable, collapsible

5. SAW GUARDS for Table saws and Band Saw provide ultimate protection.



HTC PRODUCTS, INC.
120 E. HUDSON, ROYAL OAK, MICHIGAN 48067

FREE CATALOG! CALL 800-624-2027/(313)399-6185, ext. 120

READER SERVICE NO. 35

Discover the Secret of Professional Quality Dovetails

FREE BROCHURE!

Our free brochure shows you why commercial woodworking shops all over America are choosing the Leigh Dovetail Jig. Only Leigh's patented sliding finger assembly allows dovetails to be cut in any size or spacing, for a truly handcrafted look. Why settle for less than the best in your home woodworking shop?

Call 1-800-663-8932 today for free brochure, plus comprehensive, seven-page jig comparison report. In Canada collect 604-464-2700



Terrie Noll, custom furniture maker, Oakland, CA. Traditional wall cabinet with dovetailed carcass and drawers of solid Honduran mahogany. Ms. Noll's work is featured in FWW Design Book 4.



LEIGH INDUSTRIES LTD. P.O. Box 357 Port Coquitlam BC V3C 4K6

shows only one side of a figure. And to work on the left side of a horse, for example, using a picture of the right side is confusing and difficult.

The solution is to have the picture duplicated on transparent film at a graphics or blueprinting supplier. It costs about one dollar a copy. Then, you have views of both the left and right sides simply by flipping the film over. By the way, an excellent animal reference source for carvers is *An Atlas of Animal Anatomy for Artists* (Dover Publications, 180 Vanick St., New York, N.Y. 10014). —George Meuse, Hockessin, Del.

Spring-loaded locking pins for toolboxes

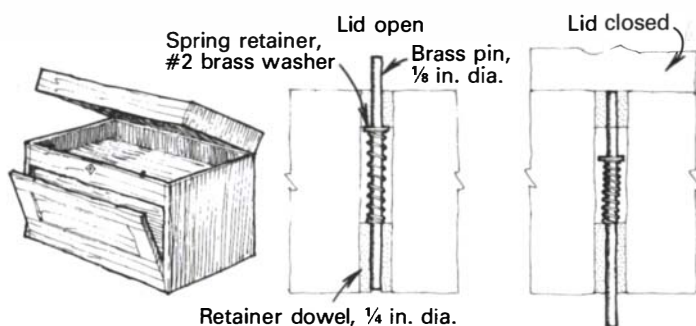

After building a toolbox that opened from both the front and top, I wanted commercial hardware that would automatically lock the front whenever the top was closed. I couldn't find anything that would do it, so I designed my own spring-loaded locking pins.

Make a full-scale sketch of the mechanism to find the length of the pin, where to solder the spring retainer, etc. Then, cut the pin

from 1/8-in. brass rod and use a #2 brass washer for the spring retainer. You can hand-ream the hole in the washer to 1/8 in. with a drill bit, and then push the washer onto the pin and solder it in place. Cut the 1/4-in. retainer dowels to length and bore a hole, slightly larger than the pin's diameter, down the center of each.

Now, drill 1/4-in.-dia. holes in the front apron of your toolbox for the retainer dowels. Glue the bottom retainer dowel into place. Then, place a ball-point pen spring on each pin, insert the pins into the holes and hammer the top retainer dowel into place. I left the top dowel unglued so I can disassemble the pin mechanism if it needs repair. —David Van Ess, Arlington, Wash.

Quick tip: An indispensable aid in my shop is a 25-lb. bag of lead shot. I use it to hold down sliding jigs on the tablesaw, dampen vibrations in delicate workpieces and weigh down hard-to-clamp joints for gluing. —M. Felix Marti, Monroe, Ore.

Long-reach clamping

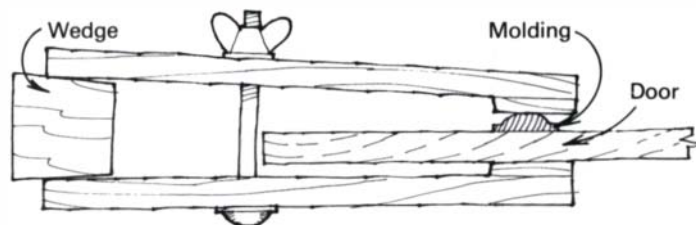

Most C-clamps do not have very long reaches and special long-reach clamps are too expensive to have around for just occasional use. So, when I needed to glue molding on the flat face of a door, about 5 in. from the edge, I adapted a system I used

DOMESTIC & FOREIGN HARDWOODS

Quality stock for
Cabinet Work

Most all sizes from
1" up to 4" in thickness

HARDWOODS

ASH—BASSWOOD
BIRCH—BUTTERNUT
CHERRY—CHESTNUT
EBONY—MAPLE—OAK
POPLAR—ROSEWOOD
TEAK—WALNUT
Also hardwood plywoods

SOFTWOODS

SUGAR PINE—CYPRESS
CEDAR—SPRUCE
DOUGLAS FIR etc.

MAURICE L. CONDON CO., INC.

248 Ferris Avenue
White Plains, N.Y. 10603
914-946-4111
Monday through Friday
8 AM to 4:30 PM

EVERLAST
SAW & CARBIDE TOOLS, INC.
1406 Utica Ave. • Brooklyn, NY 11203
1-800-TCT-SAWS (718) 968-8500
CA 1-800-221 SAWS FAX (718) 629-3652

STELLAR QUALITY BLADES with a super-smooth cut, created for you—the professional woodworker or craftsman.

Designed to cut aluminum, Corian, laminate, wood or any difficult material with ease.

Our complete line of innovative products is as close as your nearest distributor. Call or write for our complete catalog with safety guide and technical information, or call our professional staff for the technical assistance anytime.

"THE MADE IN AMERICA BLADE"
SAN FRANCISCO • NEW YORK

Ebac Lumber Dryers



Now You can Kiln
Dry your own lumber.
Let Ebac
show you how.

Call us today.

Ebac Lumber Dryers

5789 Park Plaza Ct. Indianapolis, IN 46220
(317) 577-7870 1-800-433-9011

With One Call You Get It All!



All DELTA Rebates will apply.

34-781	1-1/2HP Unisaw With Unifence	1529
34-782	3HP Unisaw With Unifence	1729
34-763	3hp 1ph unisaw	1549
34-761	1-1/2hp 1ph unisaw	1299
34-897	50" DELTA unifence	349
34-915	30" DELTA unifence	279

31-730	6" belt/12" disc sander	1069
32-100	plate jointer NEW	369*
34-995	3 ph stock feeder	849
34-994	1 ph stock feeder	949

50-180	1hp dust collector	394*
50-181	2hp dust collector	559*
17-900	16-1/2" drill press	449
31-380	4"x13 1/2" edge sander	1299
70-200	20" drill press NEW	779
36-040	8-1/4" comp. mitre NEW	159

34-444	10" contr. saw complete	649
37-154	6" jointer w/stand	1049
31-340	1X42 belt/8 disc sander	189
46-204M	12" wd lathe w/stand	1089
34-330	8-1/4" bench saw	199
34-080	10" mitre saw	205

34-740	Super 10 saw NEW	399
34-429	10" radial arbor saw	999
33-990	10" lifting arm saw	579
33-890	12" radial arm saw	1249
33-150	8-1/4" sawbuck	499

31-050	1X30 belt sander	79
40-150	15" bench scroll saw	139
11-950	8" bench drill press	139
31-460	4" belt/6" disc sander	149
23-700	Wet/Dry grinder	159

SENCO

SFN-1
1 1/2" Fin. Nailer
\$268

SN-4	6d-16d frame nailer	474
SN325	6d to 12d nailer NEW	449
SFN-II	1-1/2" to 2-1/2" fin. nailer	398
M-II	1-3/8" to 2" HD stapler	348
LS-2	5/8" to 1" brad tacker	254
LS-5	1" to 1-1/2" brad tacker	288
PW	roofing stapler	248

Nails and Staples Priced to Sell!

PERFORMAX ST

Per-ST100
Radial Saw
Surface Sander
\$289

Pro Stand	349
Powerfeed Attachment	299
Pro Max II	1399
Super Max	1999

realist
Duvid White Instruments
LP6-20
20 X Sight
Level Package
\$204

ALP6-18HD	18 auto level pack	399
AL8-22	automatic level	429
LT6-900	level transit	259

Complete Line In Stock!

BOSTITCH

N128-1
Coil Roofing
Nailer
\$399

N805-1	16d stick nailer	409
N80C-1	coil nailer	399
N86C-1	coil nailer NEW	499
N100S-1	6d-20d nailer	479
N60FN	1-1/4" to 2-1/2" fin. nlr	339
T28-5	1-3/16" finish stapler	269
T31-1	5/8" to 1" brad tacker	149
CWC100	1hp 4gal. compressor	329

Nails and Staples Priced to Sell!

PORTER-CABLE

555 Plate
Jointer W/Case
\$165

352	3X21 sander w/bag	134
360	3X24 sander w/bag	179
362	4X24 sander w/bag	189
503	3X24 wormdrive w/bag	345
504	3X24 wormdrive sander	335
330	Speed bloc finish sander	59
505	1/2 sheet finish sander	114

9850
3/8" Cordless 12V
Driver/Drill Kit
\$129

690	1-1/2hp router	129
691	1-1/2hp D-handle router	139
537	1-1/2hp Speedmatic rtr.	205
518	3 hp 5 speed router	339
696	router shaper table	119
695	router table w/router	209
7538	3-1/4hp VS Plunge router NEW	9345

BALDOR

L3504M
1/2 HP 1 ph.
1725 TEFC
\$105

L3507M	3/4hp1ph 1725 TEFC	120
L3506	3/4hp1ph 3450 TEFC	120
L3510M	1hp1ph 1725 TEFC	140
L3509M	1hp1ph 3540 TEFC	145
L3514M	1-1/2hp1ph 1725 TEFC	185
L3513M	1-1/2hp1ph 3450 TEFC	195
L3516M	2hp1ph 1725 TEFC	190
L3515M	2hp1ph 3450 TEFC	230

shop-vac

610-50
10 Gallon Stainless
Steel Wet/Dry Vac
\$169

464-38 12 gal Wet/Dry 169

HEGNER

Multi-Max II
With Stand
\$659

Complete Line In Stock!

POWERMATIC

1660760
66 Saw
3HP with 50"
Biesemeyer
\$1649

All Powermatic Priced to Sell!

DEWALT

1707
8-1/2" Compound
Crosscutter Saw
\$449

7770-10	10" 3-1/2hp radial saw	799
7790	12" 3-1/2hp radial saw	999

Qual-Craft

2200
Pump Jack
\$59

2201	brace	21
2203	guard rail holder	23
2204	work bench	41

Emqlo

AM78-HC4V
1-1/2 HP Vert.
Twin Tank
\$299

AM99-HC4	2 hp twin tank NEW	359
AM78-HC4	1-1/2hp twin tank	289
AM39-HC4V	3/4hp vert twin tank	279
K15A8P	1-1/2hp whilbarrow	599
K2A8P	2hp whilbarrow	649
K5HGA-8P	5hp honda whilbarrow	699
045	3/8" X 50" Goodyear hose	20

BIESEMEYER

50-B
50" Commercial
\$299

52B	52" homeshop fence	239
40B	40" homeshop fence	219
28B	28" homeshop fence	209

Milwaukee

1676-1
2 Speed
Hole Hawg Kit
\$224

0359-1	3/8" VSR cds drill kit	159
0222-1	3/8" VSR 3.5A drill	99
0234-1	1/2" VSR Magnum drill	109
0244-1	1/2" VSR Magnum drill	109
0385-1	3/8" VSR 7.2 V cds kit	109

6507
VS Sawzall
With Case
\$129

6508VS	sawzall w/case	129
5397-1	3/8" hammer drill kit	139
5375-1	1/2" Mag. hammer kit	169
6256	VS jig saw	129
6142	4-1/2" grinder kit	114

JET

JWP-12
12" Portable
Planer
\$379

JWP-12D	dust chute	22
DC-610	1 hp dust collector	249
HES-6108	6"x108" sander NEW	1349
JSS-6168	stroke sander NEW	1549
OVS-10	osc. spindle sander	1549
SWSS-3-1	sliding table shaper	1849

Complete Line In Stock!

BLACK & DECKER

3047-09
7-1/4" Super
Saw Cat
\$169

2663	3/8" VSR cds drill kit	119
2687	3/8" VSR cds drill kit	129
1703	10" miter saw w/ct blade	179
3048-09	8-1/4" super sawcat	179

BOSCH

1273DVS
4X24 VS
Belt Sander
\$185

1273D	4X24 sander w/bag	179
1272D	3X24 sander w/bag	169
3270D	3X21 sander w/bag	129
1290D	1/2 sheet finish sander	139
3050VSRK	9.6V drill kit/2 batt.	139

1581VS
VS Top Handle
Jig Saw
\$128

1582VS	barrel grip jig saw	124
1654	7-1/4" saw w/ct bl.	99
11212VSR	3/4" rtr. hammer kit	199
3258	3-1/4" power plane	129
1632VSK	VS recip. saw kit	135

1611EVS
3-1/4HP
VS Router
\$238

1611	3 hp plunge router	195
1604	1-3/4 hp router	118
1606	1-3/4 hp D-hndl. rtr.	149
1609K	3 in 1 trimmer kit	169
1611-220V	3-1/2hp router	259

RYOBI

RA200
8-1/4" Radial
Arm Saw
\$238

R500	2-1/4hp plunge router	148
R501	2-1/4hp plunge router	158
RE600	3hp VS elec plunge rtr.	198

AP10
10" Portable
Planer
\$348

TS251U	10" mitre saw	178
JP-155	6-1/8" joint planer	318
BE321	3X21 VS elec belt sander	128

Panasonic

EY6200B
12 Volt 1/2"
Cordless Driver
\$199

EY6205B	12V, 3/8" VSR Drill	229
EY5718	9.6V, 3/8" VSR Drill	139
EY5038	2.4V, 2-Sp. Screwdriver	69
EY571H	Steel carrying case	25

HITACHI

C8FB
8-1/2" Compound
Miter Saw
\$468

CB75F	resaw bandsaw	1629
F1000A	planer/jointer	1529
C15FB	15" Miter saw	389
C10FA	10" Miter saw	279
C12FA	12" miter saw NEW	349
TR-12	3hp plunge router	179
M12V	3-1/4 hp VS router NEW	259

LEI

D1258-24R
24" Dovetail Jig
\$299

D1258-12R	12" dovetail jig	259
LJV	Instructional video	29
MMTA-12	mortise/tenon attach	229
MMTA-24	mortise/tenon attach	249

Dugco

Zambesi
2' X 5.5'
Solid Teak
Bench
\$769

Deluxe	1'9" X 4.7' workbench	429
Major	2'23" X 5.5' workbench	529
Carver	4.2' X 1.35' workbench	269

Freud

JS100
Jointing System
With Case
\$154

EB-100	edge bander NEW	249
EC-900	5pc shaper cabinet set	279
94-100	5pc router cabinet set	159
91-100	13pc 1/2" router bit set	199
92-100	26pc router bit set	299
90-100	15pc router bit set	159
88-100	9pc router bit set	99
FB-100	16pc Forstner bit set	149
FRT-2000	router table	169

Makita

6093DWX
3/8" VSR
W/ Keyless
Chuck
\$138

6093DW	3/8 VSR cds drill kit	128
6012HDW	3/8 2 sp. cds drill kit	118
3612BR	3hp rd base router	199
LS1020	10" mitre saw	249
410	dust collector	269
2708W	8-1/4 table saw w/ct bl.	259

Mill-Route

MR1/MR-R1
Mill Route
\$289

Elu

3338
2-1/4 HP
Electronic V.S.
Plunge Router
\$259

3337	2-1/4hp plunge router	239
3304	1hp elec. plunge router	179
40900	1hp router acces. kit	135

4024
3" X 21" Elect.
V.S. Belt Sander
W/Sanding Frame
\$199

4029	4X24 belt sndr. w/frame	329
3375	3-1/8" universal planer	189
3380	jointer/spliner	319

Adjustable CLAMPS

8" Handscrew
\$12

1	10" handscrew	13
2	12" handscrew	15
3	14" handscrew	19
4	16" handscrew	25
2/0	7" handscrew	10
3/0	6" handscrew	9
4/0	5" handscrew	9
5/0	4" handscrew	8
7224	24" l-bar clamp	17
7236	36" l-bar clamp	18
7248	48" l-bar clamp	20
7260	60" l-bar clamp	23

Qual-Craft

2201 brace 21
2203 guard rail holder 23
2204 work bench 41

Mill-Route

MR1/MR-R1
Mill Route
\$289

CALL TOLL FREE FOR MIKE OR TOM **1-800-358-3096** FAX US YOUR ORDER! **1-701-772-8725**

Box 1716 • Grand Forks, ND • 58206

Mar.-Apr. Send \$2.00 For 170 Page Catalog Prices Subject to Change.

FEDERAL EXPRESS **VISA** **DISCOVER** **MasterCard**

TOOL CRIB

OF THE NORTH
DIVISION OF **Acme**

Errors Subject to Change. **LIMITED OFFER**

*** FULL LINE DISTRIBUTOR *** FREE FREIGHT IN CONTINENTAL USA *** FACTORY AUTHORIZED SERVICE ***

in my boat-building days.

In boat work, when parts had to be held together far from an edge, we fastened two boards loosely together with a nut and bolt. Then, we adjusted the bolt so that when a wedge was driven between the open ends, the other ends would clamp down on the parts.

For my door molding application, driving a wedge into the clamping strips would have moved the molding. So I carefully placed the wedge in position without hammering and then simply tightened the clamp arms with a wing nut.

—Percy Blandford, Stratford-upon-Avon, England

Shopmade vise design

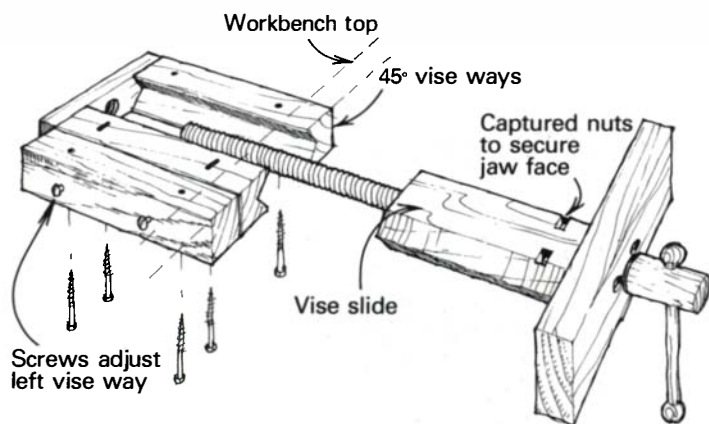

Since my traditional woodworker's workbench is not located against a wall, I decided to add a third vise on the back side across

from the tail vise. The ways are designed like a cross slide on a metal lathe, and they consist of two 45° channeled blocks that are mounted under the bench with lag screws. One of the ways is adjustable, as shown in the drawing, to allow for humidity changes.

I attached the face of the vise to the slide with 3/16-in. bolts and captured nuts. Originally, I built this vise using 3/4-in. threaded steel rod. Later, I acquired a 1-in. wood threading outfit and have now converted the screw to 1-in. wood. Both the vise body and screw are hickory.

—James L. Dunlap, Hartsville, S.C.

Quick tip: If troubled by machine lock-knobs vibrating off, spread a small dab of beeswax on their threads. This seems to work indefinitely.

—Dixon Corum, Jackson, Tenn.

Spiling for making patterns

Nail in stick is used to locate critical points on shape to be duplicated.

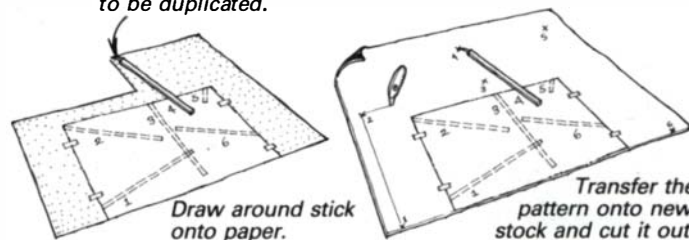

Spiling is a method for making very accurate patterns for flooring or countertops. A nail in one end of a stick is placed at critical points on the to-be-duplicated shape and the other end is traced onto a piece of paper. The paper and the stick can then

MOBILE "K" FILTER

Captures Dangerous Respirable Dusts

removes

- Fine Sawdust
- Ceramic & Fiber Dusts
- Plaster Dust
- Oil Mist

\$296.50

Tech Paper, Inc.

64 Euclid Ave., Pittsfield, MA 01201
(413) 499-3351



READER SERVICE NO. 64

MIRRORA - BEVELED CIRCLES

PERFECTLY BEVELED MIRROR

- 6 sizes of circles from 1 1/2" to 6" and 63 other sizes, shapes and colors available • 1,000,000 pieces in stock—UPS Shipable—Ready-to-go
- Highest quality float glass—Double-backed for protection • We fabricate any shape or size of glass & mirror
- Call 1-800-MIRRORA Now to place orders and get our color catalog

FLORAL
Glass & Mirror, Inc.

895 Motor Parkway
Hauppauge, New York 11788
516/234-2200 800-647-7672



READER SERVICE NO. 30

One Stop Wood Shop

Hardwood plywood, 30 species in stock (exotics made to order), hardwood lumber and marine plywood all under one roof. Custom cutting services to your exact specifications with little or no waste and at competitive prices! And, we specialize in bundling and shipping.

Call (617) 666-1340 today for catalog and quotations.

Boulter Plywood Corp.
24-FW Broadway, Somerville, MA 02145

READER SERVICE NO. 13

BOSTITCH
FASTENING CENTER

TOLL FREE 1-800-262-5482

N-80C Coil Framers SALE \$418

1 1/4" x 2 1/2" Finish Nailer w/Exclusive Dial-A-Depth SALE \$79

T-28-5 1 3/16" Finish Stapler SALE \$269

T-3650 1/2" Crown Decking Gun SALE \$329

M111FS Pneumatic Hardwood Flooring Stapler SALE \$588

N-12B Coil Roof Nailer SALE \$418

658030 8" Carbide Dado Set SALE \$105

Same Day Service

AMANA TOOL CORP. Makita
"A Bit Better"

55392 5 Finger Joint Assembly (cuts one thru five fingers in single pass) FREE 1 3/8 x 1 3/8 x 1/2 Abrasive Belt Cleaner w/Any Makita Belt Sander

DA3900 9.6V 3/8" Cordless Angle Drill w/Keyless Chuck List Price \$180 SALE \$108

RV2000 Var Spd Orbital Jig Saw List Price \$260 SALE \$118

Makita Keyless Chuck for Cordless Drills List Price \$930 SALE \$488

2012 12" Planer w/double sided blades List Price \$930 SALE \$488

Call 1-800-2-MAKITA

HOME LUMBER CO.
449 WHITEWATER ST., WHITEWATER, WI 53190

FREE FREIGHT

READER SERVICE NO. 203

SAVE MONEY!
KILN DRY LUMBER



MAKE MONEY!

Kiln Dry for others. As the nation's largest manufacturer of dehumidification Dry Kilns, we can supply you with the same type equipment used by many of the major firms.



Call or write today for free facts that will help you make and save money.

1-800-777-NYLE

207-989-4335 Nyle Corporation
 P. O. Box 1107, Bangor, Maine 04401

SQUARE DRIVE SCREWS

Simply the Best!

- Square Drive Beats Driver Slippage
- Hardened Steel for Extra Strength
- Deep Thread for Super Grip
- Also Brass & Stainless Steel

Send \$3 for Samples and Catalog

McFEELY HARDWOODS

P.O. Box 3, Dept FW81
 Lynchburg, VA, 24505
 Toll Free 1-800-443-7937
 or FAX (804) 847-7136

READER SERVICE NO. 29

A good miter is hard to find.

Made in New England

Now you know where to look!

POOTATUCK CORPORATION

P.O. Box 24, Dept. FW903
 Windsor, VT 05089 (802) 674-5984

Name _____
 Address _____
 City/State/Zip _____

READER SERVICE NO. 44

150,000 REASONS WHY YOU SHOULD OWN A T-SQUARE SAW FENCE.

Over 150,000 in fact. Bob in Buffalo. Jim in Phoenix. Richard in Sydney. Heinz in Stuttgart. The list of Biesemeyer T-Square saw fence owners spans the globe.

Why so many? Because Biesemeyer sets the industry standard. The T-Square saw fence system cuts precision parts for all your home shop projects. Safely. Affordably.



Biesemeyer's famous T-Square saw fence system fits any table saw. Shown here with our new BladeGuard™ system.



Biesemeyer's new sliding table system makes cross-cutting a breeze.

And now Biesemeyer introduces the new sliding table. Perfect for cross-cutting.

By using the T-Square sliding table on your table saw, you get the benefits of a radial arm saw—for a fraction of the cost.

Cap off your saw fence and sliding table with the added safety of Biesemeyer's new BladeGuard system. Safety was never this convenient before. BladeGuard easily lifts out of the way for dado cuts and sliding table use.

For more information, call 1-800-782-1831. In Arizona, 835-9300. And for useful hints on the many uses of our products, just ask for Bill Biesemeyer, fellow woodworker.

1-800-782-1831

Try them for two weeks. If you're not completely satisfied, you'll receive a full refund plus shipping costs.



BIESEMEYER®
 It still costs less to own the best.

READER SERVICE NO. 11

be used to transfer the critical points onto the stock to be cut out, allowing perfect reproduction of the original shape.

Here are tips that will help when spiling. Work clockwise and number each recording consecutively. It may help to make a quick sketch showing the locations for the numbered points. It simplifies the process if you can work from a straight edge. Tape the paper on this straight edge and measure from one side of the paper to one end of the straight edge. Using this measurement, locate the paper on a straight edge of your new stock and mark the pattern.

—Lynn Mickelson, Seattle, Wash.

Another featherboard

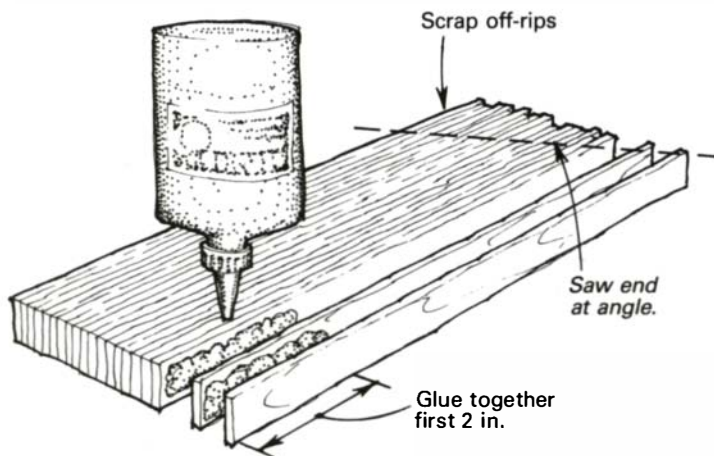

Periodically, as I'm processing lumber on the tablesaw, I'll generate a large number of small flexible off-rips that are

identical in size. This is something I'm sure many woodworkers have encountered. So a few years ago, I started recycling some of these scraps into useful materials—featherboards.

I start with enough 1-ft.-long pieces to make a board 3 in. or 4 in. wide, dab glue on just the first 2 in. or so of each piece and clamp the lot together. If they misalign slightly during clamp-up, I just run the newly made "board" through the planer and trim the end to the angle I want. Now, the featherboard is ready for use. I like to screw two featherboards to a baseboard and then clamp the base to the tablesaw. I set the featherboards so one contacts the workpiece just before it enters the blade and the other just after it exits.

—M. Felix Marti, Monroe, Ore.

Quick tip: When making intricate cuts on the scroll saw or bandsaw, first cut out the pattern from paper and then stick it to the wood with clear tape. I have found that this pattern is much easier to follow than a dim pencil line.

—Charles H. Price, Winnsboro, Tex.

Quick tip: To avoid first-degree burns on my fingertips whenever I build up a head of steam with a cabinet scraper, I wear the rubber finger caps, commonly used for sorting paper. Besides deflecting the friction heat, the caps, available at office supply stores, provide a slip-free grip.

—Steve Barrett, Kalispell, Mont.

Methods of Work buys readers' tips, jigs and tricks. Send details, sketches (we'll redraw them) and photos to Methods, Fine Woodworking, Box 5506, Newtown, Conn. 06470-5506. We'll return only those contributions that include an SASE.

FELDER **BF5**

With over 30 years of experience in the manufacture and design of industrial precision woodworking equipment, FELDER is pleased to introduce the new standard in universal woodworking machines.

The high quality FELDER machines are ideal for woodworking shops of all types and are the ultimate tool for the expert woodworker.

Send for our free program brochure or call if you have immediate requirements!

The FELDER Program:

- 10-16" Jointer/Planer
- 12" Tilting Table Saw with optional scoring unit
- 1-1/4" Tilting Spindle Shaper
- 1/2-5/8 Boring/Mortising Table
- 18-31" Bandsaws
- Individual and Universal Machines

Complete Woodworking System

Table Saw + Shaper

IMPORTER U.S.A.
ADVANCED MACHINERY IMPORTS LTD.
 P.O. BOX 312 · NEW CASTLE, DE 19720, 302 · 322 · 2226

IMPORTER CAN.
 MONTREAL OFFICE: 2059 CHARTIER AVE. DORVAL, QUE. H9P 1H3 TEL.: (514) 636-6271

TORONTO OFFICE: 3386 PALGRAVE RD. MISSISSAUGA, ONT. L5B 2H1 TEL.: (416) 277-1937

ON SALE

FREEBORN

SHAPER CUTTERS

A. NEW 8 PC. SETS FOR 1 3/8" & 1 3/4" DOORS (3 STYLES)

FOR 3/4" SPINDLE SHAPERS
 IN CARBIDE \$325 (LIST \$498); IN TANTUNG - \$350 (LIST \$527)

FOR 1 1/4" SPINDLE SHAPERS
 IN CARBIDE \$425 (LIST \$688); IN TANTUNG - \$450 (LIST \$729)

B. 6 PC. CABINET DOOR SETS (3 STYLES)

FOR 1/2" OR 3/4" SPINDLE SHAPERS
 IN CARBIDE \$225 (LIST \$329); IN TANTUNG - \$250 (LIST \$359)

FOR 1 1/4" SPINDLE SHAPERS
 IN CARBIDE \$325 (LIST \$435); IN TANTUNG \$350 (LIST \$460)

C. RAISED PANEL CUTTERS (9 STYLES)

FOR 1/2" OR 3/4" SPINDLE SHAPERS
 IN CARBIDE \$99; IN TANTUNG \$109

FOR 1 1/4" SPINDLE SHAPERS
 IN CARBIDE \$145; IN TANTUNG \$155

To order call 1-800-243-0713; Inquiries 606-255-5444

MANNY'S WOODWORKER'S PLACE
 602 South Broadway, Lexington, Kentucky 40508
 Hours Mon.-Sat. 9-5:30/Visa, MC, Checks, add \$3 for COD

We'll Stand On Our Heads To Please Our Customers.

Another Way To Look At Routers.

Freud's new **FT2000, 3-1/4 HP Plunge Router** with 1/2 inch collet has been engineered with your needs for a safe and versatile tool in mind. The mighty **3-1/4 HP** motor is the most powerful you can buy.

When mounted under a router table the Freud FT2000 can take the place of a more expensive spindle shaper.



Four major features separate the FT2000 from other routers and make it a pleasure to use!

The **Long Collet**, 1-3/8 inch long, allows for a longer, more even grip of the bit shank. This decreases run out and increases operating safety.



The **Micro-adjustment Depth Control** makes accurate vertical settings quick and easy. An effortless turn of the knob does the trick!

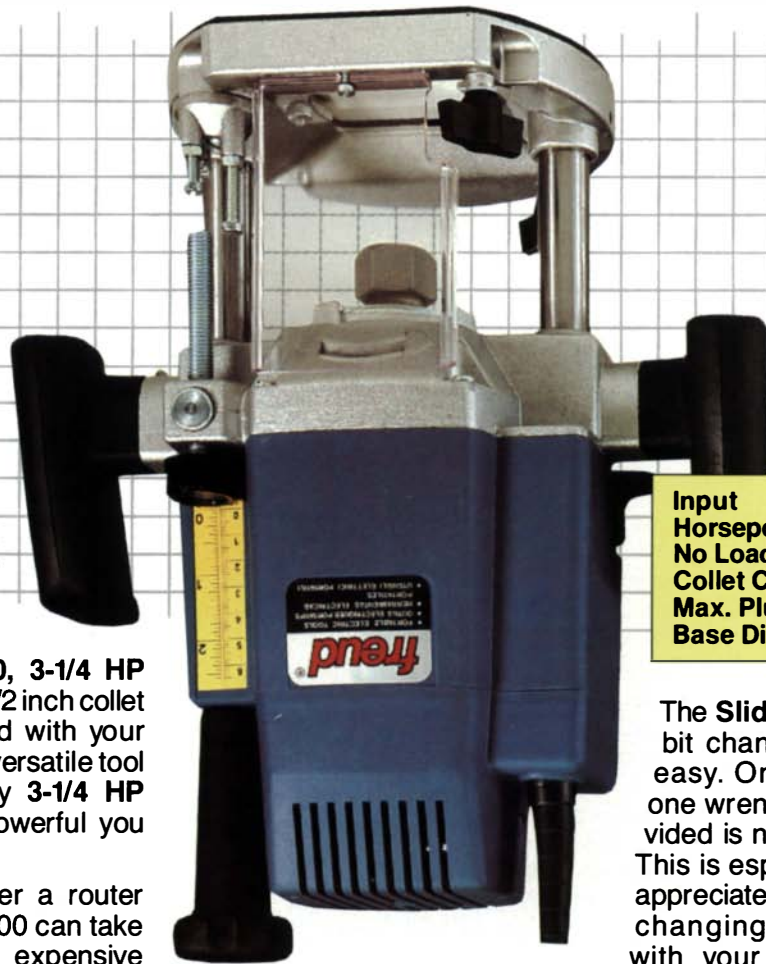

Input	15 Amps	120 Volts AC
Horsepower		3-1/4
No Load RPM		22,000
Collet Capacity		1/4", 1/2"
Max. Plunge Depth		2-3/4"
Base Diameter		6-5/8"

The **Sliding Shaft Lock** makes bit changing simple, safe and easy. Only the one wrench provided is needed. This is especially appreciated when changing a bit with your router mounted under a table.

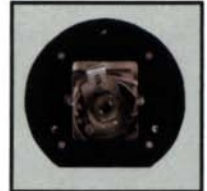

Safety was an important factor when the on-off switch and the plunge lock were designed! Both were created with a downward stroke to disengage each feature. The on-off switch is controlled by the left hand and the plunge lock is controlled by the right hand.



A 1/4 inch collet reducer and collet wrench are standard with this powerful machine. Optional accessories include micro-adjustment parallel fence and set of template guides. To get your hands on the FT2000, 3-1/4 HP Plunge Router call us for the name of your local Freud distributor!

freud®

Precisely what you need.

High Point, NC • (919) 434-3171

Carving melaleuca

I am a beginning wood sculptor and recently acquired several 8-in.-dia. freshly cut logs of a wood called melaleuca. This hardwood looks interesting in color, with light sap, somewhat reddish heart and fine, close grain. Can you tell me more about the wood, how to work it and keep cracks to a minimum as the wood dries?

—Tom Barnard, San Clemente, Cal.

Jon Arno replies: Melaleuca is a member of the same family as eucalyptus (*Myrtaceae*) and is native to Malay, Indonesia, New Guinea and parts of eastern Australia. Like eucalyptus, it has been planted in warmer regions all over the world and really adapted in various ways to local conditions. Since it was cut in southern California, the species you have is probably *M. quinquenervia*. This species is capable of attaining heights of 100 ft. and diameters of about 24 in. Although it's not an ideal timber producer, since the main stem seldom grows straight, melaleuca is commercially available and usually marketed under the common name "cajeput." Within its native range, the wood is used extensively for cabinetwork, carving, plywood veneers and construction timbers. Because cajeput has excellent weathering properties, it is also used for fence posts, railroad ties and boatbuilding.

Cajeput's very fine texture holds detail well and its natural luster allows it to take a nice polish. But from a sculptor's or carver's perspective, it has some rather negative features. With an average specific gravity of 0.65 (oven dry weight/green volume), it is about as hard to work as our domestic hickories; for example, shagbark hickory's specific gravity is 0.64. Forest Products Laboratory tests further indicate cajeput has high silica content, up to 0.95%, and this will quickly dull carving tools. Also, the wood is extremely unstable. Its very high, average volumetric shrinkage of 16.2% (green to oven dry) is compounded by the fact that it shrinks more than twice as much tangentially as it does radially and the resulting stresses make it prone to checking. For this reason, it should not be used unless it is thoroughly dry and, unfortunately, it is a very tricky wood to season. The endgrain must be well sealed with hot wax or glue and it should be allowed to air dry slowly. Treating it with polyethylene glycol (PEG) is an option, but this is expensive and will alter the appearance of the wood.

[Jon Arno is a woodworker and amateur wood technologist living in Schaumburg, Ill.]

Quieting a noisy planer

I own a Makita 2040 15-in. thickness planer that's a very satisfactory machine in all ways except noise. I'm a hobbyist woodworker and have had some complaints about noise on the weekends, even though I generally only use the machine briefly. I wonder if there's any way to make the planer more quiet by way of soundproofing or mechanical modification?

—D.F. Faulkner, Christchurch, New Zealand

Richard Preiss replies: Much to my chagrin, and surely to yours as well, there does not appear to be an aftermarket fix for the noise generated by your Makita 2040. In establishing the initial design parameters for this planer, I suspect that size, weight and performance (not to mention the final cost) were emphasized over the issue of sound generation. The Makita's universal motor and the high-operating RPMs necessary to achieve a reasonable number of cuts per inch with a two-knife cutterhead make this planer an inherently noisy machine.

As soundproofing is concerned, I believe that a plywood housing or hood lined with fiberglass insulation could be placed over the entire machine. I think this would provide enough sound dampening to appease all but the grouchiest of neighbors. The short duration of use, coupled with your apparent sensitivity to the problem, is also helpful. On the downside, the cover

would mean some inconvenience, since it would limit access to the controls and impede setting thickness of cut.

Unfortunately, I do not know of any mechanical modifications that would help you. Traditional methods of achieving quieter machine operation involve powering the tool with enclosed induction motors, and building bases and tables with cast iron to dampen vibrations and noise. It would be next to impossible to install a quieter-running induction motor without the appropriate mountings, space and couplings, none of which are available for the 2040 model. The use of a cutterhead with spiral cutting knives is an expensive noise-cutting solution on larger machinery, again, not available for the Makita.

[Rich Preiss is head of the woodworking program at the University of North Carolina at Charlotte and a Consulting Editor to *FWW*.]

Stripping a faux finish

I have recently stripped an antique dresser. On the drawer fronts of this dresser was a beautiful pattern that disappeared as the finish was stripped off. I was quite disappointed because I thought that it was the grain pattern of the veneer. Can I reproduce the grain effect to restore the original finish? I've also noticed that the molded edges around the drawer fronts are stained quite dark, with very little of the grain pattern showing. Is this typical on fake-grain furniture?

—Chad Beecroft, Guelph, Ont., Canada

Michael Dresdner replies: The field of refinishing abounds with horror stories similar to yours, in which an unsuspecting refinisher stripped off a printed finish or an antique "faux boise" finish to find a bland whitewood substrate beneath what appeared to be walnut or rosewood. Although this practice is becoming less common, large panel manufacturers often upgraded cheaper woods by covering the surface with either paper or vinyl that's printed and textured to look like figured wood. An alternative method was to use a photo process that develops the pattern onto the wood in much the same way an image is printed onto photographic paper. In either case, it is impractical to try to reproduce this kind of finish.

You can indeed restore the faux finish on your dresser by applying "fake graining": a set of techniques whereby you hand-apply glazes and stains to imitate the grain patterns of natural wood. For guidelines on this venerable craft, try Nat Weinstein's book: *Woodgraining, Marbelizing and Glazing*, from Restoration Workshop, 489 27th St., San Francisco, Cal. 94131; (415) 641-5528. Or check out Joann Day's excellent video: *Woodgraining, Marquetry, & Fantasy Graining*, by Day Studio, 1504 Bryant St., San Francisco, Cal. 94103; (415) 626-9300.

The dark stain you noticed around the molded edges of drawer fronts is frequently applied to hide the edges of the plywood or lumber substrate. Though it can be effected with a darker stain, it is more common to "even up" these edges with a second or even third application of stain applied between the layers of finish to make them "take" with more uniformity. Although dyes can be used, finishers generally use pigmented stains or glazes for this operation because of their opacity and, hence, excellent hiding ability.

[Michael Dresdner is a Contributing Editor for *FWW* and an instrumentmaker and finishing consultant in Perkasie, Pa.]

Bleeding knots in pine

I recently built some cabinets out of #2 pine, finished by spraying two coats of white lacquer primer undercoat and two coats of off-white, semi-gloss lacquer. Now all the knots have bled through the finish. What should I have done to prevent this and what can I do now?

—Frank Simon, San Luis Obispo, Cal.

David Rudolph replies: When you say that the knots bled through, I assume you mean the pine sap came up through the

GILLIFT™

"Work Smarter,
Not Harder —
Gil-Lift-It"

SAVE TIME!
SAVE MONEY!
SAVE YOUR
BACK!

The fastest, safest way to install cabinets. Constructed with the strongest structured aluminum made. This time-saving tool is a must for the kitchen cabinet industry.

- Now one person can do the job of two
- Lifts 300 lbs.
- Avoids back strain and injury
- Speeds up installation time
- Rolls easily through doorways

CALL OR WRITE
FOR FURTHER INFORMATION

GILLIFT

1605 N. River
Independence, MO 64050
Phone (816) 833-0611

READER SERVICE NO. 31

No workshop is
complete without it...

AMAZON'S 100%
PURE TUNG OIL

\$8.95 Pints
\$14.95 Quarts
plus \$3.00 Shipping, UPS/
Continental US, Visa or
Mastercharge, Order, Toll-Free:

1-800-832-5645

Or Send Check/Money Order To:
AMAZON OIL CORP.
P.O. Box 530156
Miami Shores, FL 33153



AMAZON

READER SERVICE NO. 3

APPALACHIAN HARDWOODS

America's Finest Quality Controlled
Kiln Dried - Surfaced 4 Sides

3/4" thick - 2" - 12" widths - 1 - 7ft. lengths
Approx. 20 sq. ft. packs - random L. and W.

CHERRY clear	\$52.00	#1 - \$45.00
RED OAK clear	\$46.00	#1 - \$32.00
RED OAK (wormy) clear	\$76.00	#1 - \$54.00
WHITE OAK clear	\$42.00	#1 - \$28.00
SOFT MAPLE		\$29.00
WALNUT		\$58.00
ASH		\$46.00
POPLAR		\$28.00

Orders shipped C.O.D. by UPS.

Shipping Charges Added

(PA. Residents - Add 6% Sales Tax)

To Order: 814 - 463 - 7413

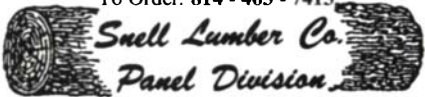

P.O. Box 6 - West Hickory, PA. 16370

ISN'T IT TIME TO TAKE THE DANGER OUT OF FINISHING?

HYDROCOTE®

With HYDROCOTE® Finishing Products we've responded to your health needs, environmental concerns along with fire safety and insurance requirements.

HEALTH

HYDROCOTE® Finishes are non-toxic and virtually odor free. They require minimal spraying facilities. Perfect for on site work.

PRODUCTIVITY

HYDROCOTE® Finishes provide 2.2 times faster build than typical nitrocellulose lacquers, are quick drying, form nearly twice as hard film, are non-yellowing and, *do not* blush in extreme heat or humidity.

AIR QUALITY STANDARDS

HYDROCOTE® Finishes comply with present and future air quality standards in every state - including California. Unlike nitrocellulose lacquers or other solvent based finishes, HYDROCOTE® Finishes *do not* effect ozone depletion.

EASY TO USE

HYDROCOTE® Finishes can be applied by brush, rag, conventional air or turbine spray systems. Water clean-up.

FIRE SAFETY

HYDROCOTE® Finishes are non-flammable and non-combustible. Since there are no explosive fumes, no need for explosion-proof equipment or hefty insurance bills.

COST EFFICIENT

On the average, HYDROCOTE® Finishes cost 3.75¢ per square foot of coverage compared to 5.25¢ per square foot for a typical nitrocellulose lacquer. A saving of nearly 30%.

HYDROCOTE® Finishes are unique and effective replacements for solvent based products used in wood finishing. The HYDROCOTE® PLUS Clear Finishes for example, are formulated to resemble nitrocellulose lacquers in terms of warmth, depth, clarity, flow, sag resistance, and drying time without any of the health, safety and environmental hazards.

The HYDROCOTE® Clear Polyurethane has been approved by the Maple Flooring Manufacturers Association for use on gym floors. It is tough and durable as solvent based finishes, yet dries 75% faster. Excellent for kitchen cabinets too. Our new HYDROCOTE® Clear POLYSHIELD™ Polyurethane is a super tough, non-yellowing finish that is UV light, weathering, impact resistant and designed for both exterior and interior application.

The HYDROCOTE® Brushable Varnish is specifically designed for those who need to brush instead of spray finish.

For more details and latest products catalog contact your local distributor:

HYDROCOTE Supply Co.
1140 Joshua Way
Vista, CA 92083
800-541-4886 619-727-9193

THETA INDUSTRIAL PRODUCTS
P.O. Box 70
Mound, MN 55364
612-471-8569

RAL North America
616 Aljo Drive
Pittsburgh, PA 15241
800-783-7883 412-531-2029

TERRY-LOCKE Distributing
2128 S. Kalamath
Denver, CO 80223
303-935-5772

HOOD PRODUCTS, INC.
P.O. Box 163
Freehold, NJ 07728
800-229-0934 201-247-2177

J.M. ROGERS PRODUCTS
P.O. Box 33279
Kerrville, TX 78029
800-828-6327 512-896-5959

FLORIDA HYDRO-FINISH
3510C. Hwy 301N
Dade City, FL 33525
904-521-4076

WOOD FINISHING SUPPLY CO.
100 Throop Street
Palmyra, NY 14522
315-597-3743

LYLE'S WOODWORKING MACHRY
1600A East 4th Street
Marshfield, WI 54449
800-472-5680 715-384-9998

HIGHLAND HARDWARE
1045 N. Highland Ave, NE,
Atlanta, GA 30306
404-872-4466

SEA STAR TIMBER CO.
P.O. Box 513
Newport, OR 97365
503-265-9616

AIRFAST
2-645 Belfast Road
Ottawa, Ontario, Canada K1G 0Z4
800-267-7707 613-233-0073

LYLE'S WOODWORKING MACHRY
1319 Frost Ave
Maplewood, MN 55109
800-624-5359 612-771-0167

HYDROCOTE Supply Co.
217 So. 5th Street
Perkasie, PA 18944
800-899-JANE 215-453-8663

WATER BASED FINISHES
10 Sword Street
Toronto, Ontario, Canada M5A 3N2
416-924-7900

READER SERVICE NO. 21

final finish. To prevent this problem in my pine furniture and sculpture, I apply a coat of a good sealer, like Kilstain (available from most paint and hardware stores), over the knots before priming and lacquering. The sealer prevents the sap from coming up through the finish. To repair your cabinets, you can try repainting the problem areas with white lacquer paint, and then semi-gloss lacquer as you did before. You can retouch those spots only, or you may have to repaint the entire piece to match the new paint. If the sap still comes through, you'll have to strip the cabinets and start over with the sealer.

If you're having a problem with the knot outlines showing under the paint, like an imprint (called telegraphing), you could cover the knots with a bondo-type putty (I like Minwax putty) that mixes in two parts and does not shrink. Spread it over each knot with a putty knife, sand it when dry and use a good sealer to prevent bleed-through.

[David Rudolph is a wood sculptor and furnituremaker in Santa Barbara, Cal.]

Calculating lathe pulley speed

The motor on my wood lathe runs at 1,725 RPM and there is a 4-in.-dia. pulley on the motor shaft and one the same size on the speed-changer shaft. On the other end of the speed changer and on the headstock are matching four-step pulleys with 4-in., 3 1/4-in., 2 1/2-in. and 1 3/4-in. diameters. How can I calculate the rotational speed of the lathe with the belt set on different pulley steps?

—Michael H. Kirch, Lucerne, Cal.

Roger Heitzman replies: The formula for calculating pulley speed is fairly simple: pulley speed = motor speed × drive pulley diameter, with that product divided by the diameter of the driven pulley (the one mounted on the lathe). The diameters

of all pulleys are measured at the rims. For example, if we combine your lathe's motor speed with the 3 1/4-in. to 2 1/2-in. steps on the multiple-step pulleys, we can calculate the speed with the formula: (1,725 (RPM) × 3.25) ÷ 2.5. This would yield a final headstock speed of 2,242 RPM, good for general spindle turning. It's worth noting that shaft diameter has no bearing on this equation and that pulleys of equal size produce equal speeds, such as between the motor pulley and speed changer pulley.

[Roger Heitzman is a furniture designer and a craftsman in Scotts Valley, Cal.]

Discourse on Dutch elm disease

I have acquired some wood from a dead elm tree cut in southeastern Pennsylvania and I'd like to turn some bowls and vases. I don't know what kind of elm it is or what killed the tree. The tree was dead for about two years before I cut it and the wood has some spalting in it. Somebody told me that this wood is capable of spreading Dutch elm disease. Is there any truth to this?

—Earl Edris, Mt. Gretna, Pa.

Walter R. Tschinkel replies: There is no truth to it. Dutch elm disease is caused by a fungus, *Ceratostomella ulmi*, carried by the elm bark beetles, *Scolytus multistriatus* and *Hylurgopinus rufipes*. These beetles carry the spores of the fungus in concavities on their bodies, and introduce them into the cambium of healthy elm trees when they feed on twigs and small branches. As the fungus weakens and kills the tree, the adult bark beetles bore into the cambium of the trunk and major branches, excavate an egg gallery parallel to the grain and reproduce there. The next generation of adults bore out through the bark, carrying the fungal spores with them. As you can see, it takes living beetles of the appropriate species as well as bark on dead elms to spread

HOW WOULD YOU
MAKE THESE WITHOUT

Incra™
Jig
U.S. PATENT #4,793,604

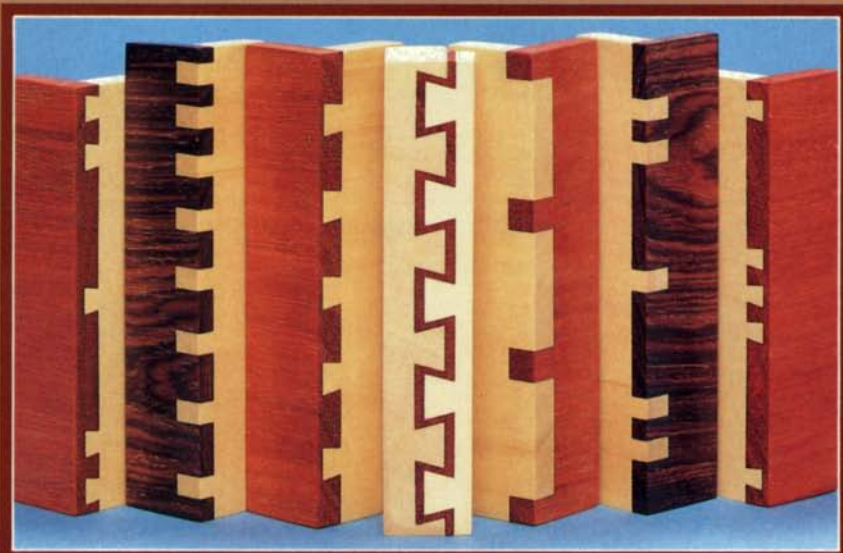

These joints were made using the new **Incra Templates**, with **Incra Jig** on the router table.

The intricate and beautiful joints shown here are just a small sampling of the flawless work that you can now readily accomplish with the unprecedented performance and accuracy that this remarkable new tool puts in your shop. No other dovetail jig, regardless of cost, can even come close to matching INCRA JIG's precision and versatility.

But the **INCRA Universal Precision Positioning Jig** is much more than just a dovetail and finger joint jig. It operates in **EXACT** 1/32" steps as a precision fence or stop block on your **router table, drill press, table saw, band saw, radial arm saw,** and more. Over-all error is under 1/500", and you can instantly return to any former position with a repeatability error that is unmeasurable.

Now Available

Set of 17 templates plus full-sized plans for making all of these joints plus hundreds of unique and beautiful variations. Just set INCRA JIG to the color-coded reference marks, and then rely on the precision of INCRA JIG's sawtooth positioning racks to lock each cut exactly into place for a perfectly fitting joint.

Handbook has 100 illustrated pages with detailed instructions and tips on getting the most out of your INCRA JIG. Includes expanded sections on making sliding, half-blind, and **THROUGH** dovetails with **ANY** combination of pin and tail spacing, using **ANY** dovetail bit ever manufactured. Features a special section on making INCRA Double Dovetails.

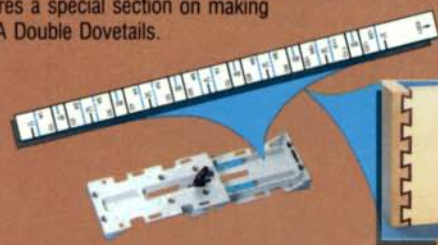

For a free brochure and your nearest dealer, write to:
Taylor Design Group, Inc. P.O. Box 810262 Dallas, TX 75381
INCRA Templates with included handbook are sold separately from INCRA JIG.

ORDER TOLL FREE 1-800-328-0457 - MAIL ORDER HOURS 7:00-5:30 C.S.T. MONDAY-FRIDAY

DELTA BENCH TOP TOOLS

Model	Description	List	Sale
23-700	Wet/dry grinder	201	155
23-680	6" bench grinder 1/4 H.P.	81	89
23-680	6" bench grinder 1/2 H.P.	138	109
23-680	10" bench grinder 1 H.P.	246	235
11-950	8" drill press	184	135
14-440	14" drill press	313	309
40-150	15" hobby scroll saw	178	139
28-180	10" hobby band saw	189	144
31-050	1" belt sander 2.0 amp.	93	78
31-460	4" belt/s disc sander	178	139
31-340	"NEW" 1" belt/s disc sander	226	175

DELTA STATIONARY

Model	Description	List	Sale
34-781	10" unisaw 1 1/2 H.P.	1715	1339
34-760	Super 10" motorized table saw	690	449
34-420	10" tilting arbor bench saw 1 1/2 H.P.	1479	1049
33-990	10" radial arm saw	727	575
11-072	32" radial drill press	487	409
37-280	6" motorized jointer	440	370
50-179	3/4 H.P. 2 stage dust collector	435	339
50-180	1 H.P. dust collector	535	439
50-181	2 H.P. dust collector	730	605
37-154	Deluxe DJ-15 6" jointer w/4 H.P. motor	1288	1029
22-561	13" planer w/2 H.P. motor	1750	1119
33-050	"NEW" 8 1/2" Sawbuck	742	569
34-330	"NEW" 8 1/2" Table Saw 13A	321	245
34-670	10" motorized table saw	437	379
34-965	1/2 H.P. stock feeder	698	539
32-100	"NEW" stationary plate jointer	645	449
36-840	"NEW" 8 1/2" compound miter saw	216	155

MILWAUKEE TOOLS

Model	Description	List	Sale
0399-1	"NEW" 12V cd/s v/asp drill w/batt., charger & case	280	155
0395-1	9.6V cd/s. drill w/cse	284	149
0219-1	9.6V cd/s. drill w/cse	277	165
0385-1	7.2V cd/s. drill w/cse	174	109
0224-1	3/4" drill 4.5A magnum	189	114
0234-1	1/2" drill 4.5A mag 0-850 rpm	199	107
0244-1	1/2" drill 4.5A mag 0-600 rpm	199	107
0222-1	3/4" drill 3.5A 0-1000 rpm	174	99
0229-1	3/4" drill 3.5A 0-1000 rpm	164	96
0375-1	3/4" close quarter drill	206	118
0379-1	1/2" close quarter drill	243	149
0539-1	Cordless screwdriver 190 rpm	113	89
0540-1	Cd/s. screwdriver w/bits & cse.	154	99
0546-1	Cd/s. screwdriver 200 & 400 rpm	120	75
3102-1	Pimbs rt angle drill kit	330	185
3062-1	Electricians rt angle drill kit	320	185
5399	1/2" D-hdie ham drill	304	185
1676-1	H.D. Hole Hawg w/cse	415	224
1611	2 sp SawZall w/case	214	125
6405	8 1/4" circle saw	219	129
6756-1	Drywall gun 0-4000 4.5A	154	89
6507	TSC SawZall w/case	229	129
8170	14" chop saw	430	275
6012	Orbital sander 3 1/2"x7 1/2"	189	109
6014	Orbital sander 4 1/2"x9 1/2"	185	115
6305	6 1/2" cordless circle saw	299	175
8977	Var. temp heat gun	114	75
5397-1	3/4" v.sp. sander hammer drill kit	232	139
5371-1	1/2" v.sp. sander hammer drill kit	318	185
3107-1	1/2" v.sp. rt angle drill kit	340	195
6754-1	Drywall gun 0-4000 4.5A	179	119
6747-1	Drywall driver 0-2500	154	95
0230-1	3/4" drill 0-1700 rpm	179	105
3300-1	1/2" v.sp. magnum rt angle kit	299	185
5660	Router 1 1/2 H.P.—10 amp	299	189
5660	Router 2 H.P.—12 amp	350	225
5455	1/2" polisher 1750 rpm	209	129
6215	16" chain saw	280	179
8975	Heat gun	89	59
6365	7 1/4" circular saw	195	114
6366	7 1/4" circ saw w/fence & bld.	204	119
6368	7 1/4" circ saw w/fence, bld & cse	233	129
0216-1	2 spd cordless drill Hi-torque	222	129
0235-1	1/2" drill keyless chuck motor	209	119
6016	1/2 sheet pad sander	79	52
6145	4 1/2" grinder 10,000 rpm	154	95
6142	6 1/4" w/cse & access.	192	115
6749-1	Drywall gun 0-2500 4.5A	189	125
6377	7 1/4" worm drive saw	295	189

FREUD SAW BLADES
5/8" Bore—Industrial Grade
CARBIDE TIPPED SAW BLADES

Item No.	Description	Di. (in)	Tooth	List	Sale
LUT220010	Gen.Purp. A.T.B.	10"	40	50	39
LUT1001010	Gen.Purp. Tr.Ch.	10"	40	65	43
LUT220010	Cut-off	10"	60	77	45
LUT4001010	Combination	10"	50	65	42
LUT0001010	Super Cut-off	10"	80	96	56
LUT720010	Ripping	10"	24	57	38
LUT730010	Cut off	10"	60	70	44
LUT770010	Thin kerf	10"	24	60	39
LUT0001010	Thin kerf	10"	60	74	44
LUT0001010	Ultimate	10"	80	107	60
LUM0001010	Non-ferrous metal	10"	72	87	55
P2303	Gen'l Purp.	7 1/4"	24	25	19
P2303	Playwood	7 1/4"	40	36	27
D2300	6" Dado - Carbide			184	186
D2300	8" Dado - Carbide			196	112
F10	1 1/2"x3/4" Biscuits 1000-City			32	27
F10	2 1/2"x3/4" Biscuits 1000-City			32	27
F20	2 1/2"x1" Biscuits 1000-City			34	29
FA	Assorted Biscuits 1000-City			34	29
WC104	4 pce. chisel set w/cse 1/4" x 1"			54	39
WC106	6 pce. chisel set w/cse 1/4" x 1"			73	52
WC110	10 pce. chisel set w/cse 1/4" x 1 1/2"			119	75
WC116	16 pce. forstner bit set 1 1/2"			284	155
94-100	5 pce router bit door system			288	155
J1800	Circle Jointer w/case			306	159
C2R2	Planer w/cse carb bld & guide			216	129
F7200	3 1/2 H.P. plunge router			299	189

MAKITA CORDLESS

Model	Description	List	Sale
6070DW	3/4" var. spd. rev. drill, 7.2v	130	78
6071DWK	3/4" var. spd. rev. drill w/removable batt, 7.2v	195	109
5090DW	3/4" saw kit, 9.6v	256	139
5060DW	6 1/4" circular saw, 10.8v	350	179
6010DWK	3/4" cordless drill kit, 7.2v	164	95
6010SDW	3/4" cordless drill, 7.2v	99	65
DA3000DW	3/4" angle drill, 7.2v	281	136
3400DW	Hammer drill kit, 9.6v	272	149
4390DW	9.6 volt cd/s. recip saw kit	230	128
4300DW	Jig saw kit comp., 9.6v	232	128
6012DW	2 spd. driver drill w/clutch & case, 9.6v	236	117
5092DW	V/spd. drill, kit complete	250	123
5093DW	V/spd. drill w/clutch—complete	261	127
5891DW	Drywall gun 0-1400, 9.6v	237	129
632007-4	9.6 volt battery	48	30
632002-4	7.2 volt battery	40	28
5007NBA	7 1/4" saw w/elec. brake	233	128
5008NBA	8 1/4" saw w/elec. brake	284	158
804510	1/4 sheet pad sander	85	49
9900B	3"x24" belt sander w/bag	268	148
99240B	3"x24" belt sander w/bag	282	152
9045A	1/2 sht fin. sand. w/bag	231	134
4200N	4 1/4" circ. saw 7.5 amp	225	127
4301BV	Orb. v/sp. jig saw 3.5 amp	289	196
JR3000V	Vs. recip saw w/case	227	129
LS1020	New 10" miter saw	463	249
9820-2	Blade sharpener	373	209
1900B3	3/4" planer w/case	209	115
1100	3/4" planer w/case	401	219
92078PC	7" sander-polisher	278	186
3601B	1 1/2 H.P. router	255	139
3700B	1/2 H.P. trimmer	190	115
9601B2	4" grinder, 3.5 amp	126	75
804530	6" round sander	101	59
804550	1/4" sheet pad sander w/bag	96	55
DA3000R	3/4" angle drill	270	148
DP4700	1/2" v/sp w/rev. 4.8 amp	209	125
HP210N	3/4" v/sp hammer drill w/cse	300	169
2700R	8 1/4" table saw	504	259
Z711	10" table saw w/brake	941	489
2030N	12" planer/jointer	3120	1789
2040	15 1/2" planer	2995	1489
1906B	6 1/2" planer kit w/case	679	359
50058A	5 1/2" circular saw	223	129
95058R	4 1/2" sander-grinder	146	89
6464	3/4" drill 0-2100 rpm, 2 amp.	164	85
6510LR	3/4" drill rev. 0-1050 rpm	145	79
6015BR	1/2" circular saw - 12 amp	648	359
3616BR	3 H.P. plunge router	371	195
3620	1 1/2 H.P. plunge router w/bag	319	189
4302C	V/spd. orb. jig saw	182	109
5077B	1 1/4" Hypoid saw	252	138
1414	14" Miter saw	721	425
2414	14" cut-off saw AC/DC	361	205
5007NB	7 1/4" circ saw 13 amp	209	114
3612B	3 HP plunge router sq/b	377	195

DELTA TOOLS

Model	Description	List	Sale
34-444	Table Saw Complete w/1 1/2 H.P. motor & stand	629.00	
34-445-34-444	Table Saw complete w/30" Unifence	799.00	
33-150	8 1/4" Saw Buck	485.00	
28-283F	14" Bend Saw w/enclosed stand & 1/4 H.P. motor	699.00	
70-200	NEW 20" Dr III Press	719.00	
17-900	18 1/2" Floor Drill Press	385.00	
40-501	18" Scroll Saw w/stand and blades	699.00	

SENCO AIR NAILERS

Model	Description	List	Sale
SFN1	Finishing nailer 1" - 2"	371	269
SFN2	Finishing nailer 1 1/2" - 2 1/2"	571	396
SN325	Nailer 1 1/4" - 3 1/4"	665	448
N2	General purpose 1 1/4" - 2"	475	345
SN4	General purpose 2" - 3 1/4"	685	489
S12	Pinner 3/4" - 1"	361	255
SK3	Stapler 3/4" - 1 1/2"	361	249
L85	Pinner, 1 1/2"	399	265
PW-RFR	Roofing, 1 1/2"x1 1/2"	361	255

SKIL SIZLERS

Model	Description	List	Sale
5510	(551) 5 1/2" circ saw	112	85
5825	(552) 6 1/4" circ saw	175	124
5855	(553) 7 1/4" circ saw	132	119
5750	(807) 7 1/4" circ - drop foot	188	142
5785	(808) 8 1/4" circ - drop foot	216	149
5790	(810) 10 1/4" circ - drop foot	400	269
5825	(367) 6 1/4" worm saw	229	155
5865	(825) 6 1/4" worm saw	250	164
4580	Vari - orbit jig saw w/cse.	144	105
3810	10" Miter saw	263	215
7675	1 1/4" palm sander	52	49
7313	3x18 belt sander 4.5A	72	65
77	7 1/4" worm drive saw	230	145
5350	2 1/4 HP circ. saw	80.99	77
5250	2 1/4 HP circ. saw	88.99	66
2736-04	12v v/spd. cordless drill complete w/cse & 2 batt.	210	139

LEIGH DOVETAIL JIGS

Model	Description	List	Sale
D1258-12	List 314.00—Sale 265.00		
D1258-24	List 375.00—Sale 305.00		

LEIGH INSTRUCTIONAL VIDEO—SALE 29.00

Model	Description	List	Sale
MNT 500 NEW 24"	multiple mortise & tenon jig	509	399
MNT 12"	multiple mort. & tenon attachment for D1258-12	299	219
MNT 24"	multiple mort. & tenon attachment for D1258-24	299	239

HITACHI TOOLS

Model	Description	List	Sale
TR9	Plunge router, 1 1/2 H.P.	219	119
M120	NEW 3 H.P. var/spd. router	437	255
TR12	Plunge router, 3 H.P.	354	175
C10FA	10" dix. miter saw	496	278
C2FB	6 1/2" slide compound saw	859	489
FREUD LU91M006	6 1/2" c/bld 48 tooth	58	45
C15FB	15" miter saw	745	399
FREUD LU85M015	15" c/bld 108 tooth	181	115

1990 TOOL CATALOG AVAILABLE
Call Toll-Free 1-800-328-0

the disease. Even recently, dead elm wood without attached bark would not spread the disease. And your two-year-old, partly spalted elm wood is far beyond being able to spread Dutch elm disease. [Walter Tschinkel is an entomologist living in Tallahassee, Fla.]

Making a quilting hoop

I would like to make some hoops for holding small quilts or needlework while the pieces are being worked on. Which woods are most suitable and what would be a good, low-tech way of bending and joining the wood for this purpose? Also, can you suggest any books on the subject?

—Claffertene M. Cheeks, Newark, N.J.

Drew Langsner replies: The best woods for bending are those with long, tough fibers. These include most oaks, ash, hickory, pecan and walnut. You can also use clear maple, cherry or beech, but expect more failures. For bending hoops, select wood free of all imperfections. The grain should have little run-out from side to side and, as can be expected, thinner pieces will bend easier than thicker ones. A scarf joint is best for joining the ends of the hoop together, and these can be formed with a plane, spokeshave or abrasives. Make the scarf joints before bending, but join the ends after the bends are set.

To make the wood more pliable just prior to bending, heat the strips by ladling boiling water over them, or by steaming or "cooking" them in an open tray. For quilting hoops, the bending form can be a plywood disc (made as thick as necessary) mounted to a plywood back. Use pegs and wedges to hold the bent wood in place while the wood cools and the bends set. I would suggest forming the outer hoop over the inner hoop after the bend on the inner hoop is set.

The simplest way to lock the scarf joint on the hoop is to use

glue. This joint would be very strong, but such a permanent fix would prevent you from adjusting the frame to allow for different thicknesses of fabric. Perhaps the inner hoop should be glued and the outer hoop left adjustable. For an adjustable joint, I suggest boring a row of overlapping holes in the hoop ends and then lacing the ends together with cord or thin leather strips. A more utilitarian approach could use a recessed stove bolt and a wing nut. For more information refer to: *Fine Woodworking on Bending Wood* (The Taunton Press, 1985) or my chapter on bending in *Green Woodworking* (Rodale Press, Emmaus, Pa., 1987).

[Drew Langsner is an author, farmer and woodworker living in Marshall, N.C.]

Homemade wood fillers

A few weeks ago, I read about making wood filler with Tite-bond glue, water and sawdust. But when I tried this method, my filler turned black. Can you explain what happened?

—Leroy D. Gifford, Zanesville, Ohio

George Mustoe replies: Polyvinyl acetate-based adhesives (white and yellow wood glues) may show two types of color change. When used at low temperatures, the glue turns chalky white during curing. Black discoloration might be due to iron contamination; even traces of iron will cause the adhesive to react with tannins (found in some woods, like oak) to produce a dark stain. In both instances, the glue's final bonding strength is not effected by the color change. Iron contamination is also the reason that you'll sometimes get dark stains at the glue line after gluing up a panel or tabletop with iron pipe or bar clamps; contact between clamp and fresh glue results in the stains.

Iron contamination can occur during the manufacturing process, but far more commonly this element is introduced when

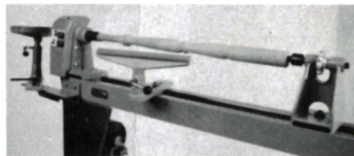
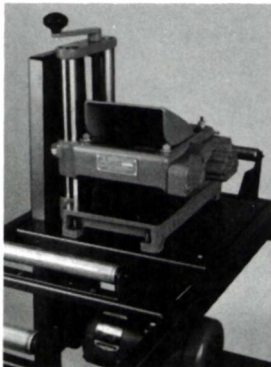

**ANYTIME
ANYWHERE
ANYWOOD**

W&H Molder-Planer & Lathe

Professionals and hobbyists alike know the strengths of our products! The W&H Molder-Planer converts from planing to molding in only two minutes, and duplicates moldings from 3/4" deep to 7" wide.

Our 12" Lathe, with its cast iron headstock/tailstock and solid steel ways, has four-speed versatility and 46" between centers!

Superior made-in-USA construction, exceptional warranties, and free 30 day trials are your assurance of long life and total satisfaction.

Mail this ad or call us toll-free today.
1-800-258-1380 In NH 603-654-6828

Williams & Hussey
P.O. Box 1149, Dept. 130CA
Wilton, NH 03086

YES! Send your free information kit today!



Name _____
Address _____
City _____ State _____ Zip _____

Deco Shapes™
Perfectly Curved Plywood

Deco Shapes™ offers perfect plywood rounds for all of your Euro-styled cabinet and furniture production. Their complete line gives you the flexibility and style you need in both commercial and residential applications.
Call today for your free catalogue.

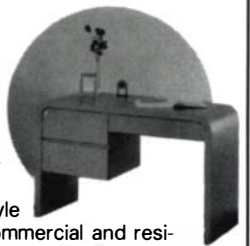

- Radius End Panels
- Quarter Rounds
- Half Rounds
- Cylinders

NO MINIMUM ORDERS!
Sizes range from: 4" - 28" Diameters and 28" - 84" Lengths

L.I. Laminates Inc.
—We Mean Service!

35 Engineers Rd. Hauppauge, NY 11788
Call Toll Free 1-800-221-5454 • In NYS 516-234-6969
FAX # 516-234-5590

Finally A Solution

to accurately setting
your table and radial arm saw

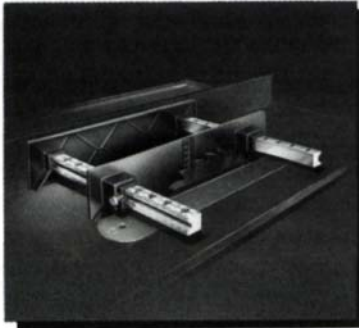

Produce fast and professional results when setting your power tool with PARAGAUGE.

PARAGAUGE accurately sets table saws, radial arm saws, band saws, drill presses and router/shaper tables by providing perfectly parallel measurements up to 10 inches in width.

If you're tired of setting and re-setting a rip fence to obtain that perfect measurement, then PARAGAUGE was developed just for you.

Why spend hundreds on complex and permanent fence systems when PARAGAUGE is completely portable and will produce the same results at a fraction of the cost.

A must for every woodworker from the HOME HANDYMAN to the PROFESSIONAL.

PARAGAUGE™

U.S. Patent Pending

To order your PARAGAUGE using Mastercard or VISA

call **1-800-343-6129**
(7day/24 hour order service)

or, if you prefer to order by check or would like a free brochure write
ACCUSET TOOL CO., INC. • P.O. Box 1088 • Dept. F • Troy, MI 48099

Michigan residents must add 4% state sales tax - No C.O.D. orders please.

Each PARAGAUGE is sold with a no-risk 30 day money back guarantee.

Introductory
Price
\$29.95
+\$3.50
shipping

READER SERVICE NO. 1

Pink Ivory
Dagame
Brazilian Rosewood
Pear
Plum
Burlis
Snakewood
Bubinga
Koa
Satinwood
Cocobolo
Padauk
Rosewood
Bloodwood
Ziricote
Purpleheart
C.Ebony
PauRosa
Camphor

Quality Exotic Wood

» TURNERS «
Thick Planks for Bowls/Squares

» CABINET MAKERS «
Individually Selected Lumber
for
Furniture/Boxes/Inlays

Over 70 Species

All Inquiries Welcome...Call or Write
Berea Hardwoods Co.
125 Jacqueline Drive
Berea Ohio 44017

216-243-4452

READER SERVICE NO. 151

Pernambuco
Mac. Ebony
E.I. Rosewood
Bocote
Curly Maple
Quilted Maple
Af. Ebony
Zebrano
Lacewood
Lignum Vitae
Osage
Tulipwood
Blackwood
Mahogany
Jelutong
Holly
Wenge
Goncalo Alves
Many More...

It's a matter of pride for both of us

1990 WOOD at HAYSTACK

Alphonse Mattia Seth Stem
Michael Pierschalla Bob Trotman



1990 one, two and three week Summer Sessions,
June 3 thru August 31. Brochure available by writing
Haystack Mountain School of Crafts, Box 87FW,
Deer Isle, ME 04627, or by calling (207) 348-2306.

READER SERVICE NO. 85

Professional Quality Woodworking Machines From PENN STATE INDUSTRIES

Super 125 Planer

Portable with "Power Feed" • Shipped assembled • Retail value over \$600.00

On Sale ... \$334.95



Add \$15
UPS
Freight

This machine will pay for itself time and again by planing your own lumber. At 65 lbs, you can carry this Planer to a job site or mount it permanently in your workshop like any stationary machine. You'll spend hundreds of dollars less for this 12-1/2" power feed Planer than for a traditional stationary model of a similar capacity - with comparable results.

SPECIFICATIONS:

- Knives.... 2ea, 12-1/2" wide, HSS
- Motor - 16 Amp, 115V, 8000 RPM
- Auto Feed rate 26.2 FPM
- Cutting speed 16000 Cuts/min
- Thickness of stock 3/16" to 6"
- Size ... 15-1/2"H X 22"W X 21" Bed
- Max Depth of cut 1/8"
- Machine Weight 65 Lbs



Free plans for roller stand with purchase of rollers

Planer & Accessories Price List

- Super 125 Planer - complete and assembled
#PLA **\$334.95** (\$15 UPS)
- Extra Set of 2 Knives - High speed steel, 12-12"
#PKN **\$ 25.00/set (-)**
- Dust chute - for vacuum takeoff of wood chips
#PDS, On Sale **\$15.00** (\$3 UPS)
- Planer stand - Heavy duty, 27-1/2" high
#PST .reg. \$44.00, On Sale..... **\$ 39.00** (\$6 UPS)
- Ball Bearing Rollers - (Minimum purchase 2 rollers)
Build roller stand, infeed/outfeed table etc. w/these 13"x2" Heavy Duty rollers. Includes FREE plans for building roller stand shown above. #BBR **\$ 6.50/ea** (\$3 UPS/per order)
- (-) No freight chg if ordered w/Planer, otherwise add \$3 UPS

DC-1 Dust Collector

On Sale ... \$189.95

Keep your shop clean and safe from sawdust with our large capacity, commercial style system. This collector has up to 10 times more air flow than a Shop Vac and runs much quieter.

SPECIFICATIONS:

- 1hp, 110/220V (pre wired 110V)
- 610 CFM air flow
- 6990 FPM air speed • 2 Bags 15"dia X 22" • 20 gallon bag
- 4" inlet • Casters on base • Weight 75 lbs • Size - 26"x15"x57"H

FREE
with Purchase of DC-1

- Duct Hose
- 4" To 3" Rigid Adaptor
- 4" To 2" Flex Adaptor
- Plans For 2 Stage Setup
- Piping & Fittings Sources

Free \$15 Value

Add \$20
UPS
Freight



We unconditionally guarantee your satisfaction with our fine machines. All of our machines carry a Thirty day Money Back Guarantee and One year Warranty for Parts and Labor.

PENN STATE INDUSTRIES - F

2850 Comly Road • Phila, Pa 19154
Order Toll Free 1-800-288-7297 (Ext 90)
For information 1-215-676-7609 (Ext 15)
Visa, Master, & Discover Card accepted
Pennsylvania residents add 6% Sales Tax
Add UPS Shipping Charges as noted
Continental U.S. only (Call for shipping charges to other locations)

READER SERVICE NO. 52

the woodworker uses steel containers or tin cans to store or mix glue. To check for contamination, spread a thin puddle of glue on a scrap of oak or other tannin-rich wood. After drying, the glue should be colorless or light amber; black or bluish stains are proof of iron contamination. The discoloration may not be noticeable in the thin film of glue present in a well-mated joint. But when the same glue is used as a filler material, the resulting mixture may turn nearly black. In the latter case, the iron contamination usually results from sawdust that includes a minute amount of iron, such as iron filings or fibers of steel wool. If your sawdust was obtained by collecting floor sweepings, it's almost sure to contain these materials; since only a few parts per million of iron can cause discoloration, be extra careful to gather clean, fresh sawdust for your filler mixture. While you may wish to put this chemical reaction to good use to produce a dark-color wood filler, you may have trouble controlling the final color of the filler, since this depends on both the amount of iron in the glue and the amount of tannin in the particular piece of wood you use for sawdust.

[George Mustoe is a geochemistry research technician at Western Washington University in Bellingham, Wash.]

Round bandsaw blades

I've heard of a specialty bandsaw blade, circa 1940, that was spiral shaped and could cut in any direction. Are these still available, and what kind of bandsaw guides would be needed to run them?

—Jeffrey Seaton, Santa Barbara, Cal.

Mark Duginske replies: Two types of round blades are available. One is a steel spiral band, the other one is a grit band. The grit that is used is either made of aluminum oxide, diamond or borazon. The round blade design allows cutting from all di-

rections, not just from the front of the blade. This option is particularly useful when using CNC (computer controlled equipment) to guide the material through the cut. Unfortunately, round blades can only be used on specially designed bandsaws fitted with guides designed to accommodate that blade shape. Further, these guides are not available to retrofit other bandsaws. If you have the need for this kind of bandsaw, the machines are manufactured by the Doall Co., 254 N. Laurel Ave., Des Plaines, Ill. 60016-4398; (312) 824-1122.

[Mark Duginske is a woodworker, teacher and author who lives in Wausau, Wis.]

Furniture mildew problems

I have some furniture that has mold or mildew which has formed spots of light-color fuzz. The furniture appears to have a lacquer finish that has been periodically maintained with lemon oil. What is the best method for removing the mold or mildew and how can the resulting spots be removed from the finish?—Stephen L. Fitzhugh, Guilford, Conn.

Chris Minick replies: Mold and mildew problems in the home are usually caused by high humidity. The best solution to your problem is to prevent it by dehumidifying the house. The mold or mildew currently on the furniture can be removed by lightly scrubbing the effected area with household chlorine bleach. If the lacquered surface is in poor condition, then refinishing may be in order. Mildewcide additives for lacquer and varnish are available at most large paint stores. The additives are mixed into the lacquer before it is applied and are very effective in preventing future mildew problems. Two mildewcides that I have found particularly effective are Troysan Polyphase AF-1 Mildew Additive by Troy Chemical Co. and M-1 Additive for Mildew



Wood Lathes

The new powerful and sturdy M-Series lathes have been designed to fulfill all the requirements of woodturners, whether professional, hobbyist, or student.

Early in 1988, Richard Raffan commented that the Australian-made Woodfast lathe was one of the top two or three available to woodturners. Since then, Woodfast has implemented several design changes recommended by Richard Raffan and Dale Nish. The result is an excellent lathe for the woodturner, and the best value for the money of any lathe on the market today. The M-Series lathes are equal to, or better than, other lathes costing nearly twice as much. We think these lathes will be readily accepted by knowledgeable woodturners.

Send \$2.00 for The Woodturners Catalog and lathe information. \$2.00 refunded with order.

Craft Supplies USA
1287 East 1120 South
Provo, Utah 84606
(801) 373-0917



M400 Woodfast Lathe

Specifications:
Swing over bed — 16"
Outboard swing — 20"
Motor — 1½ h.p. TEFC 110/220V
Distance between centers —
M400 18" / M600 38"
Spindle speeds —
370, 650, 1200, 2000 R.P.M.
Spindle size — 1¼-8 TPI
Weight — M400 460 lbs.
M600 520 lbs.

M400 \$1695⁰⁰/M600 \$1850⁰⁰
F.O.B. Provo, Utah

READER SERVICE NO. 201



DUST COLLECTION ACCESSORIES

TOUGH ABS PLASTIC

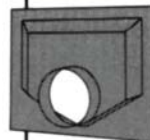

UNIVERSAL & JOINTER EXHAUST HOODS (4" outlet)

MODEL G1838 6¼"x6¼" Hood \$9.95
MODEL G1839 Fits over 6½"x6½" Chute \$9.95
MODEL G1841 Fits over 7"x8½" Chute \$11.95

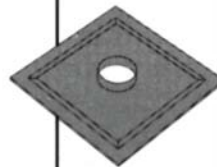

TABLE SAW EXHAUST HOOD

These 12"x12" hoods fit on the inside of the tablesaw with the 4" outlet facing down. Fits almost all 10" and 12" contractor-type saws with open stands.

MODEL G1837 ONLY \$14.95



BLAST GATES

We are the largest suppliers of Dust Collector Blast Gates in the U.S.A.!

3" MODEL G1842 ONLY \$6.95
4" MODEL G1843 ONLY \$7.95

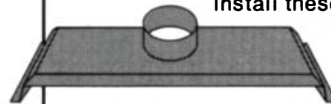

FLOOR SWEEP SYSTEM

Install these sweeps at different locations in your shop and fight over the broom at the end of the day!

- 22" wide sweep
- Stick base to floor with our 2-sided tape.

MODEL G1840 ONLY \$12.95



CALL TOLL FREE:

1-800-523-4777 (East of the Miss.)

1-800-547-5537 (West of the Miss.)

READER SERVICE NO. 74

Clayton Oscillating Spindle Sanders.

For large or small shops. Ideal for contour sanding. Quick change drums. 1/2" to 4". Satisfaction guaranteed. Covered by 1 yr. warranty. 4 models to choose from. For more information write:

Clayton Enterprises
2505 W. Dewey Rd.
Owosso, MI 48867

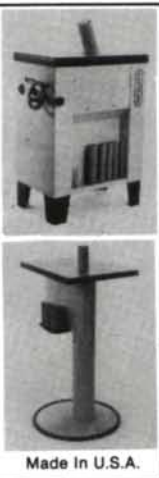

Made in U.S.A.

READER SERVICE NO. 17

TROPICAL HARDWOOD EPOXY
glues any wood we ever heard of

EPOXY FAIRING GEL
fills holes - sands like wood

CLEAR PENETRATING EPOXY SEALER
consolidates softer woods
primes for paint and varnish

SMITH & CO.

Industrial and Marine
Synthetic Resins and Specialties

5100 Channel Avenue
Richmond, CA 94804
(415) 237-6842

NEW TOLL FREE LINE
800-234-0330

READER SERVICE NO. 62



**Free
Clock
Kit
Catalog**

Send for your FREE copy of our 56-page color catalog featuring the most intriguing collection of clock and other reproduction kits in the world. Includes kits, dials, movements, tools, hardware, books and accessories.

586 Higgins Crowell Rd., Dept 2168, W. Yarmouth, MA 02673

READER SERVICE NO. 48

Full-Size Professional Plan
ADIRONDACK CHAIR



Make this classic American design. Our special version may be folded for storage by using ordinary hardware available at your local store. Be ready for Summer and get your plan now!

CATALOG 200 full-size professional furniture plans - \$3.00

Plan #700 \$12.95
(Catalog free with order)

FURNITURE DESIGNS, INC., Dept. KA-30
1827 Elmdale Ave., Glenview, IL 60025
(708) 657-7526

READER SERVICE NO. 302

EAGLE™
AMERICA

"Come Back to American Made Quality - Come Back To Eagle"

ROUTER BITS



Made
In
U.S.A.

Send for the complete 52 page mail-order catalog featuring over 900 different router bits, shaper cutters and accessories.

Send me a FREE catalog via 3rd class mail. (Allow 4-6 week delivery.)

RUSH me a copy TODAY via first class mail. I've enclosed a check for \$3.00 for special postage and handling.

BONUS - You will receive with your catalog a \$5.00 refund good towards your first purchase.

MAIL COUPON TO: **Eagle America**
BOX 1099 CHARDON, OH. 44024 FW

Name _____

Address _____

City _____ State _____ Zip _____

READER SERVICE NO. 301

JOINTER
12" planing width 13-3/4 x 72" precision ground cast iron table 3HP motor. JT-0012...\$1795

INDUSTRIAL PLANER
7 5/8" max thickness, 1/4" max cut, 3 knives, return roller, mag. switch, 3 HP, 20" max width WP-1120...\$1855
5 HP, 24" max width WP-1124...\$2655

TILTING ARBOR TABLE SAW
Cast aluminum guide rail. Quick lock fence. 3HP Motor 2Belt drive HTS0012A...\$859
3HP Motor 3Belt drive TS-1010...\$1195

DUST COLLECTOR
1HP Motor UFO-90...\$199
2HP Motor UFO-101...\$339
3HP Motor UFO-102B...\$465

WIDE BELT SANDER
3 precision bal. contact drums. Full pow. drive sanding & auto infeed. Computerized! adj. table. 24" working width A-2548...\$6150
36" working width A-3760...\$8995

STROKE BELT SANDER
60"x21-1/4" sliding table, 6" sanding belt width, 2 HP SK-1500BS...\$1295
80" x 21-1/4" sliding table, 6" sanding belt width, 3 HP SK-2100BS...\$1599

DRUM SANDER
Double drums. Dust chute. 1/4 HP feeding 15" 3 HP SK-15DS...\$1795
20" 3 HP SK-20DS...\$1975
25" 5 HP SK-25DS...\$2355

SPINDLE SHAPER
1" and 3/4" Spindle 3HP 28"x30" table F/R Switch SK-30SPA...\$849
SLIDING TABLE SK-35ST...\$199
18" BAND SAW 2HP, MBS-018...\$895

Offering a complete line of fine quality tools including...

- ✓JOINTERS ✓LATHES
- ✓MORTISERS ✓PLANERS
- ✓SANDERS ✓SAWS ✓& more!

Featuring:



POWER FEEDER
1HP, 8 Speed, F/R Two Year Warranty! CT-280F...\$990
1/4 HP SK-321FD...\$390
30 Days FREE TRIAL!

NEW! VIDEO CATALOG \$10
Refunded with (\$500) order

TRUE VALUE & TRUE QUALITY



LOBO POWER TOOLS
9034 Bermudez Street, Box 890
Pico Rivera CA. 90660
(213)949-3747

In Canada:
Unit 3, 2375 Alpha Ave, Burnaby, B.C
Canada V5C 5L2 (604) 299-0911
All F.O.B. Pico Rivera, CA

Write or call now
FREE BROCHURE
Or \$3. Catalog (\$5 refunded with order)
One year free parts warranty
We specialize in customer satisfaction

READER SERVICE NO. 46

Control by The Jomaps Co. The Troysan additive can be successfully used in both solvent- and water-base finishes, but the M-1 additive is best used only in solvent finishes. Both additives are available from paint stores.

[Chris Minick is a product development chemist and amateur woodworker in Stillwater, Minn.]

When is lacquer too old?

Is there any way to test the quality of a lacquer product? My old boss used to spray several small sample boards with different lacquers. When they were dry, he would put them in a freezer and pull them out repeatedly. The cheap ones, and presumably bad ones, always seemed to crack up. Also, what makes lacquers turn brown? Is it an indication of poor quality or does lacquer lose quality with age?

—Colin Conolly, Corvallis, Ore.

Michael Dresdner replies: Testing the quality of lacquer depends largely on how you define “quality.” The test your boss used is one that specifically targets the lacquer’s ability to withstand rapid temperature drops without cracking (called “cold checking” in the finishing industry), a characteristic that is of very little consequence for furniture finishes, unless the piece is a lacquered container designed for use in a microwave or freezer. Once furniture is placed inside a house, it will not go through radical temperature drops, since people generally like to keep their home temperature on an even keel. Hence, lacquer manufacturers often assign a low priority to a wood finishing lacquer’s resistance to cold checking. One notable exception is the finish on a musical instrument. A guitar in a case is frequently carried from a warm winter home into a chilled car trunk during the ride to the concert hall.

The finishing industry uses a number of tests to gauge a material’s characteristics, such as hardness, glossiness, cure time, chemical resistance, flexibility, etc. Formulating a lacquer product involves a trade-off whereby an increase in one characteristic means a decrease in another. Such is the case with resistance to cold checking. One way of making lacquer less susceptible to temperature change is to add plasticizer. This will increase the film’s flexibility, but also result in a reduction in brittleness that may reduce a gloss lacquer’s ability to be rubbed out to a high sheen. Lacking a complex lab, your best bet is to simply ask your suppliers about the particular qualities of the different lacquers they stock. In choosing a lacquer, it is important to decide what characteristics are important for the job at hand, and ask the supplier for a recommendation.

In regard to aging, lacquer, like many chemicals, has a limited shelf life before it goes bad. Different products have different shelf lives, which are also effected by the storage conditions both in your shop and in the warehouse where the lacquer was kept before you purchased it. Assuming the material is fresh when you buy it (an optimistic assumption at best), you should date the can at the time of purchase and toss it once it passes the manufacturer’s recommended period of use. Under favorable conditions, most lacquers have a least a one-year shelf life. However, a material will not necessarily indicate its loss of viability by turning brown, but even if it were to do so, it would certainly not occur on the short trip from the manufacturer to your shop. [Michael Dresdner is a Contributing Editor for *FWW* and an instrumentmaker and finishing consultant in Perkasio, Pa.]

Send queries, comments and sources of supply to Q & A, Fine Woodworking, Box 5506, Newtown, Conn. 06470-5506.

RF ROBLAND

The Intelligent One Man Shop

- 10" Table Saw
- 12" Jointer
- 12" Planer
- Shaper
- Mortiser
- 50" Sliding Table
- 3 motors 3 HP. ea.



- 12" Jointer
- 12" Planer
- 550 LBS.
- 3 HP. motor
- Mortiser Optional



CLASSIC WORKBENCH



Available in left & right handed versions.

Video: Send \$6 (refundable) or call us with your credit card number, to receive a 60 min. video presentation on our tools.

For information and your nearest dealer call
LAGUNA TOOLS
 2081 Laguna Canyon Rd., Laguna Beach, CA 92651
1-(800) 234-1976

WE'LL GIVE IT TO YOU STRAIGHT.



A \$100 REBATE ON OUR 8" JOINTER.

The Delta 8" Precision Jointer has the heft and accuracy to straighten you out for the long haul.

And right now it comes with a hefty rebate check, straight from Delta.*

Its 8" cutting capacity, 76½" cast iron table with full 42" infeed, and 5" x 36" center-mounted, tilting cast iron fence make it a true workhorse.

Unique parallelogram-design table support system and modular cutterhead team up to make it a fine milling instrument.

Three knives operate at 5500 RPM, extremely close to the table, to give you smooth, perfect edges, surfaces, bevels and rabbets.

And don't forget. Delta is giving you the perfect reason to buy it *now*. A hundred bucks in your pocket.

Call toll free for the name of your Delta Distributor. Delta International Machinery Corp., 800/438-2486.

*Offer good only on purchases of 8" Jointer with motor and controls from participating distributors in the continental U.S., Alaska and Hawaii from January 1 thru June 30, 1990.



BUILD YOUR OWN QUEEN ANN FURNITURE

with our wide variety of stock legs



-OR-
JUST ASSEMBLE
OUR COMPLETE KITS



SOLID
CHERRY
WALNUT
MAHOGANY
OAK

Matching coffee table available

FREE BROCHURE
(no minimum required)

Adams Wood Products, Inc.
974 Forest Dr., Dept Q5
Morristown, TN 37814 • Phone (615) 587-2942



TUNGSTEN CARBIDE ROUTER BITS

- Heavy Duty Industrial Quality
- 1/4 by 1-1/4 inch long shafts
- Enclosed Ball Bearing Guides
- Bits pass ATCS Std. 103

Corner Round-over

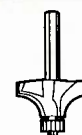

Radius	Price
1/4 "	\$12.50
3/8 "	\$13.75
1/2 "	\$14.50

Cove Bits

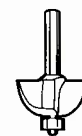

Radius	Price
1/4 "	\$14.50
3/8 "	\$15.50
1/2 "	\$17.00

45° Chamfer Bits

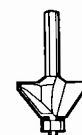

Diameter	Price
1 "	\$12.00
1-1/4 "	\$14.00
1-1/2 "	\$15.50

100% Money Back Guarantee

ORDER NOW - TOLL FREE
1-800-767-4747 24 HRS



Or mail check to:

SKYCROFT TOOLS, INC.
P.O. BOX 418W2
Myersville, MD 21773-0418

Hirsch Brand Carving Tools The world's finest



- Produced in Germany for over 200 years
- 750 sizes & shapes available
- 62-Rockwell hardness
- Unsurpassed quality and price

sold by
Northland Woodworking Supply
65 Wurz Ave.
Utica, NY 13502
315-724-1299

Call now for your complete catalog only
\$2.00 refundable with first purchase.

READER SERVICE NO. 205



CLEAR WOOD FINISH

Crystal Clear.
Dries in 30 minutes.

13 oz. Spray (6 per case) 3⁵⁷ ea.
Quarts (6 per case) 6²⁴ ea.
Gallons (4 per case) 17⁹⁷ ea.
5 Gallons 82⁰⁰ ea.



HARPER HARDWARE CO.

FULL CASES
ONLY
F.O.B.
RICHMOND,
VA

1712 E. BROAD ST., RICHMOND, VA 23223 (804) 643-9007
"Serving the craftsman since 1898 with Specialty Tools & Supplies."

READER SERVICE NO. 33

Imported European Hardware

4320 W. Bell Drive
Las Vegas, Nevada 89118
(702) 871-0722

SEND \$1.00 FOR CATALOG

READER SERVICE NO. 154

ELECTRIC BRANDING IRON

Your Satisfaction Guaranteed



- Solid Brass—lasts years
- Special wording available
- 2nd line—20 letters/spaces max.
- 1/4" letters
- Distinctive Border

- Torch heated models start at \$23.95
- Add \$2.50 shipping

\$44⁹⁵

Order by mail from:

BrandMark

462 Carthage Dr., Dept. FWW2
Beaver Creek, OH 45385
(513) 426-6843

TO ORDER CALL TOLL FREE

1-800-323-2570

(ORDERS ONLY)

8:00-5:00 EASTERN TIME

veritas® Product Development Casebook HONING GUIDE AND ANGLE JIG

THE PROBLEM

To design a system that will let you rapidly shape and hone blades at perfectly repeatable angles. It must be usable with everything from short spokeshave blades and narrow chisels to chisels and plane blades up to 2 1/2" wide.



THE SOLUTION

A honing guide and angle-setting jig that will let you set any one of 25 bevel angles from 13° to 38°. The wide roller on a 3-position camshaft lets you shape an edge at a chosen angle (i.e. 20°) and then turn the camshaft knob (i.e. to 21° or 22°) for your micro-bevel without unclamping the blade. Precision die-cast with turned brass fittings.

Another woodworking innovation from **veritas®**.

The Honing Guide & Angle Jig are available for about \$30.00 from:

•Garrett Wade •Japan Woodworker
•Woodcraft •Woodworker's Supply
of New Mexico •Lee Valley Tools Ltd. (in Canada)

Distributed by: **veritas® Tools**
12 East River Street, Ogdensburg, NY 13669

READER SERVICE NO. 43

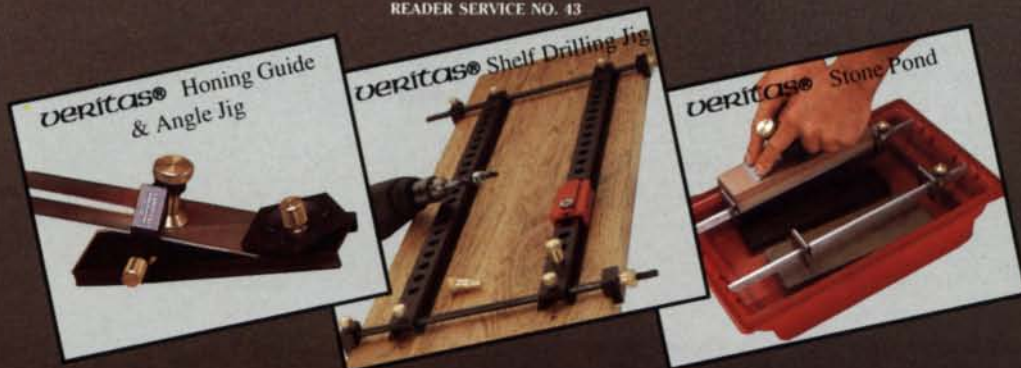

GENERAL

- **10" Table Saw**, 3 HP, 230V, Guard, Mtr Gauge, Magnetic Control **350-1** \$1380.
with 50" Beisemeyer Fence **350-T50** \$1520.
w/ 50" Paralock or Excalibur **350P50/E50** \$1585.
- **15" Band Saw**, 1 HP, 115/230V, **490-1** \$895.
- **Variable Speed Lathe**, 1 HP, 115/230V **160-2** \$1140.
with Magnetic Control **260-1** \$2065.
- **6" Jointer**, 1 HP, 115/230V **1180-1** \$745.
- **8" Jointer**, 1-1/2 HP, 115/230V **480-1** \$1520.
- **15" Drill Press**—Floor Model, 6 Speed, 1/2 HP, 115/230V **34-01** \$570.
- **14" Planer**, 3 HP, 230V **130-1** \$2645.

All 1 phase motors
All prices FOB So. Burlington, VT

SISCO SUPPLY

INC.
102 Kimball Avenue
So. Burlington, VT 05403

CALL TO ORDER/INFO

802-863-9036

READER SERVICE NO. 87

Introducing our new line of

Great woodworking books from around the world.

Just released

Marquetry

by Pierre Ramond

Here, for the first time in English, is the most in-depth and authoritative book on marquetry ever published. With the help of detailed photographs and drawings, renowned marquetry professor Pierre Ramond takes you into the marqueteur's shop to see the work firsthand and to museums in Europe and the U.S. to see the results.

HARDCOVER, COLOR, 240 PAGES, 257 PHOTOS, 101 DRAWINGS, \$59.95, #070098

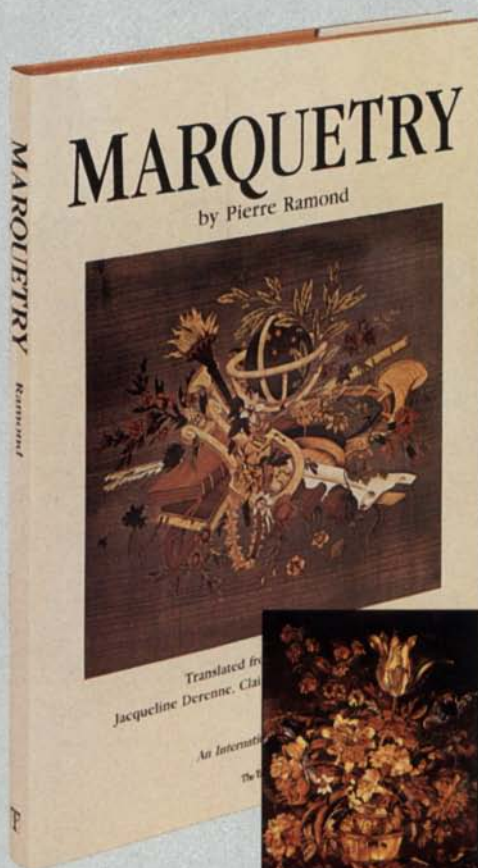

Marquetry poster
free with purchase

When you buy *Marquetry* by Pierre Ramond you'll receive, free, a breathtaking poster of one of the works shown in the book. Available for separate purchase at \$9.95. #078005



Newly revised edition

Dictionary of Woodworking Tools

by Raphael Salaman, revised by Philip Walker

Over the centuries, woodworkers have devised thousands of ingenious and practical tools to make wood do what they want. You'll find them all, virtually every woodworking tool used from the beginning of the Industrial Revolution to today, in Raphael Salaman's large, 520 page *Dictionary of Woodworking Tools*.

Originally published in 1975 in England and available in the U.S. only at an exorbitant price, this internationally acclaimed book is now revised and available from us in softcover at half the price.

To assemble the information, British woodworker and research expert Raphael Salaman logged untold hours in museums and libraries, and visited over 450 town and country workshops to see the tools in action. With the help of detailed drawings, Salaman explains each tool's origin, purpose, use, and where possible, who

designed and made it. He also gives descriptions of tools for allied activities such as sail making, leather working, and smithing. Take it from *Workbench* magazine, the *Dictionary of Woodworking Tools* is the "definitive reference for hand tools." SOFTCOVER, 520 PAGES, DRAWINGS AND PHOTOS, \$27.95, #070121

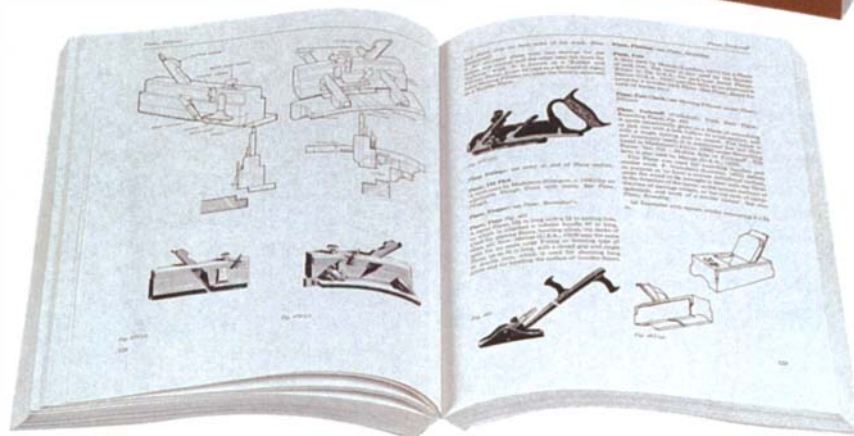
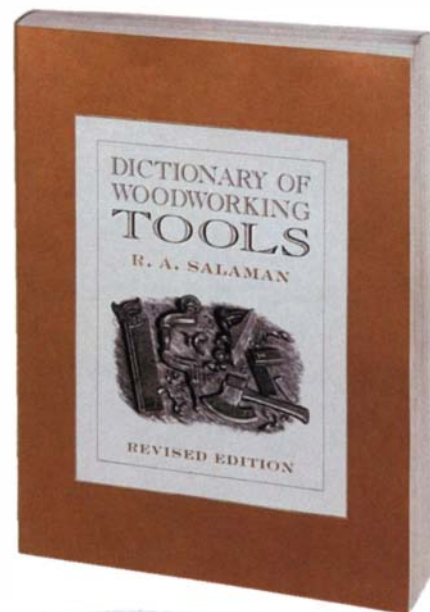

"...inspiring, indeed awe-inspiring..."
—*The Observer*

International Craft Classics

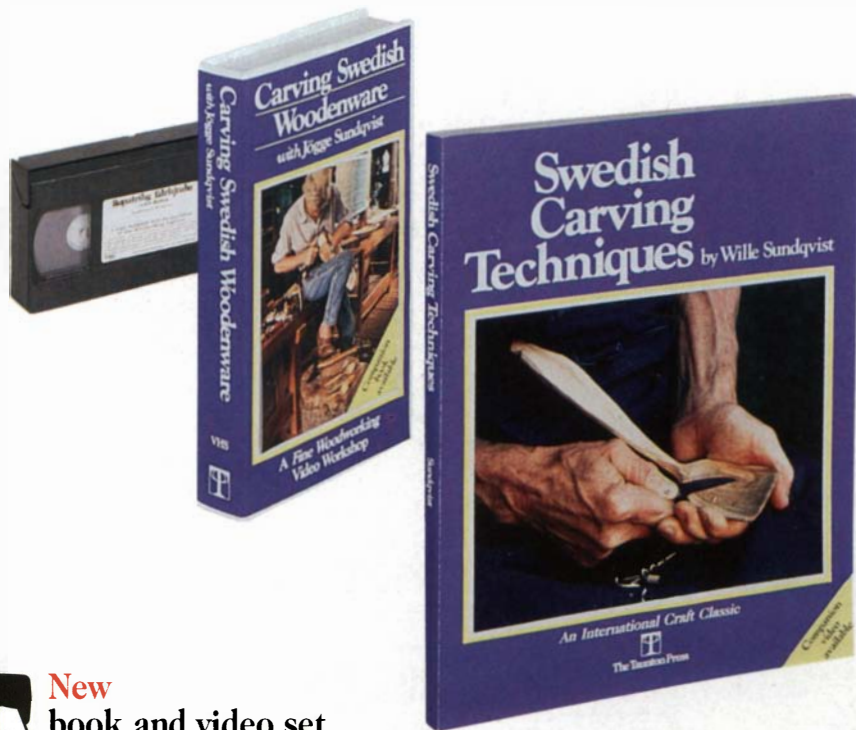

 **New**
book and video set

Swedish Carving Techniques

Traditional carvers in Sweden make lovely household implements—butter paddles, spoons, ladles and dough bowls—that those of us using power tools can't rival. Now in this integrated book and video set, Wille Sundqvist and his son Jögge show you how they do it.

Father and son draw on the rich traditions of their Swedish forefathers to demonstrate how to use a knife and ax skillfully. In the book, Wille Sundqvist provides a thorough introduction to his craft. With the help of careful illustrations, he explains the best qualities to look for in knives, axes and other edge tools, and how best to control them. By working directly with green wood rather than milled lumber, you'll get a deeper sensitivity for the material and gain complete control of the knife while cutting.

Then in the video you'll watch as Jögge Sundqvist shows you the grips, strokes and rhythms that make for successful carving. He demonstrates how to make a dough bowl and a spoon, from start to finish. And like his father in the book, Jögge explores the fundamentals of good design in spoons, bowls, and other carved utensils.

Save \$5.95 on the Sundqvist set: \$39.95, #07A135 (VHS), #07A136 (BETA)

The Book: *SWEDISH CARVING TECHNIQUES*, SOFTCOVER, 144 PAGES, 233 PHOTOS, 31 DRAWINGS, \$15.95, #070107

The Video: *CARVING SWEDISH WOODENWARE WITH JÖGGE SUNDQVIST*, 60 MINUTES, \$29.95, #060035 (VHS), #060036 (BETA)

New

27 Chairs

Best Furniture Projects from the British magazine *Woodworker*:
edited by Victor J. Taylor

Here are plans for 27 chairs you can make in your own woodworking shop. We've gathered the best chair projects of the past 80 years from the noted British magazine *Woodworker*. Each project has been chosen, checked and redrawn by Victor J. Taylor, the retired editor of *Woodworker*.

The result? You get a reference library of dimensions and construction details for every type of chair, ranging in style from ornate period pieces and sturdy Windsors to straightforward modern classics. Some feature turning, some rely on bending and some are upholstered. Whatever the project, you get complete measured drawings, detailed construction information and a cutting list so you can go out and make the chair you've always wanted. SOFTCOVER, 110 PAGES, 139 DRAWINGS, \$12.95, #070113

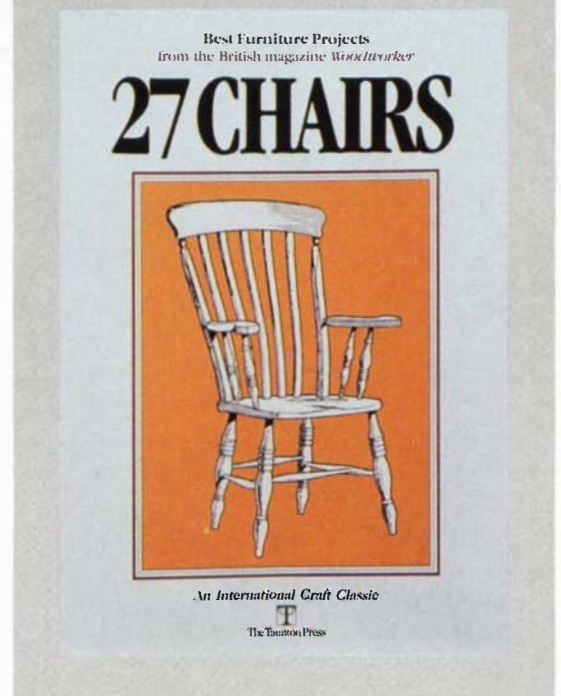

CASCADE TOOLS, INC.

P.O. Box 3110, Bellingham, WA 98227



**Finest Quality Carbide Tipped
Router Bits & Shaper Cutters**

RABBETTING



SIZE	PART NO.	PRICE
1/4" Straight	C2030	\$24.95
3/8" Straight	C2031	\$26.95
1/2" Straight	C2032	\$28.95
3/4" Straight	C2033	\$32.95
1" Straight	C2034	\$35.95
1-1/2" Straight	C2035	\$36.95
2" Straight	C2036	\$59.95

CORNER ROUND



SIZE	PART NO.	PRICE
1/4" Radius	C2059	\$24.95
3/8" Radius	C2060	\$26.95
1/2" Radius	C2061	\$28.95
3/4" Radius	C2062	\$35.95
1" Radius	C2063	\$49.95
1-1/4" Radius	C2064	\$49.95

FLUTE



SIZE	PART NO.	PRICE
1/4" Flute	C2046	\$24.95
3/8" Flute	C2047	\$26.95
1/2" Flute	C2048	\$28.95
3/4" Flute	C2049	\$32.95
1" Flute	C2050	\$35.95

BEAD



SIZE	PART NO.	PRICE
1/4" Bead	C2052	\$24.95
3/8" Bead	C2053	\$26.95
1/2" Bead	C2054	\$28.95
3/4" Bead	C2055	\$32.95
1" Bead	C2056	\$35.95

DOUBLE-FLUTED Straight



1/4" SHANK		
PART NO.	D	PRICE
C1001	1/4	\$6
C1002	5/16	\$6
C1003	3/8	\$6
C1004	1/2	\$8
C1005	5/8	\$10
C1006	3/4	\$10
C1007	1	\$12

1/2" SHANK		
PART NO.	D	PRICE
C1008	1/4	\$6
C1009	5/16	\$6
C1010	3/8	\$6
C1011	1/2	\$8
C1012	1/2	\$15
C1013	5/8	\$10
C1014	5/8	\$15
C1015	3/4	\$10
C1016	3/4	\$15
C1017	1	\$12
C1018	1-1/4	\$12
C1019	1-3/8	\$15
C1021	1-5/8	\$18

BEADING

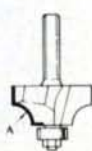

1/4" SHANK		
PART NO.	A	PRICE
C1157	1/16 R	\$11
C1158	1/8 R	\$11
C1159	3/16 R	\$11
C1160	1/4 R	\$12
C1161	5/16 R	\$13
C1162	3/8 R	\$15
C1163	1/2 R	\$16

1/2" SHANK		
PART NO.	A	PRICE
C1171	1/2 R	\$16
C1172	3/4 R	\$20

ROUNDROVER



1/4" SHANK		
PART NO.	A	PRICE
C1174	1/16 R	\$11
C1175	1/8 R	\$11
C1176	3/16 R	\$11
C1177	1/4 R	\$12
C1178	5/16 R	\$13
C1179	3/8 R	\$15
C1180	1/2 R	\$16

1/2" SHANK		
PART NO.	A	PRICE
C1187	1/2 R	\$16
C1188	5/8 R	\$20
C1189	3/4 R	\$20
C1190	7/8 R	\$34
C1191	1 R	\$34
C1192	1-1/4 R	\$40

DOVETAIL



1/4" SHANK		
PART NO.	D	PRICE
C1067	1/4	\$7
C1068	3/8	\$7
C1069	1/2	\$7
C1070	9/16	\$8
C1071	3/4	\$9

1/2" SHANK		
PART NO.	D	PRICE
C1074	1/2	\$7
C1076	3/4	\$9
C1077	1	\$12

ROMAN OGEE

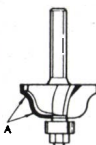

1/4" SHANK		
PART NO.	A	PRICE
C1153	5/32 R	\$16
C1154	1/4 R	\$18

1/2" SHANK		
PART NO.	A	PRICE
C1155	5/32 R	\$16
C1156	1/4 R	\$18

COVE

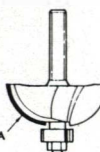

1/4" SHANK		
PART NO.	A	PRICE
C1138	1/16 R	\$12
C1139	1/8 R	\$12
C1140	3/16 R	\$12
C1141	1/4 R	\$13
C1142	5/16 R	\$14
C1143	3/8 R	\$15
C1144	1/2 R	\$16

1/2" SHANK		
PART NO.	A	PRICE
C1149	1/2 R	\$16
C1151	3/4 R	\$28

UNDERSTANDING ORIGINAL HARDWARE

UNDER THE TABLE HARDWARE . . .

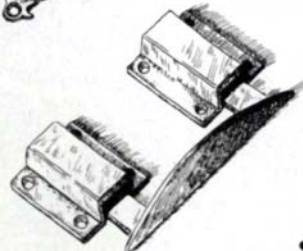
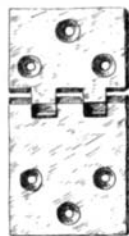

Seldom seen, usually never polished, often taken for granted, — catches for tilt top's, hinges for drop leaves and holding clips for sectional dining tables all contribute to the function of the finished piece. Square, round, lion paw, or cup casters of all sizes, using brass, china, wood, cast iron, leather, or no wheels finished thousands of legs since 1700.

Call or write for free mini-catalog, or send \$5.00 for our full 108 page catalog. We now reproduce more than 100 items like these.

BALL and BALL
Finest Quality Reproductions

463 W. Lincoln Hwy • Exton, PA 19341 • (215) 363-7330

READER SERVICE NO. 8

WOOD PARTS FROM MIDWEST DOWEL WORKS

Compare Our Low Prices!

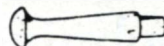

	Qty.	Cost
3-1/2" Poplar Shaker Peg	\$15/100	—
1-3/4" Mini Shaker Peg	\$7/100	—
3-1/2" Country Wall/ Mug Peg	\$15/100	—
2-1/2" Country Shorty Peg	\$12/100	—
Large Bean Pot Candle Cup	\$17/100	—
Brass Inserts	\$9/100	—
1/2" Mini Candle Cup	\$10/100	—
1-1/2" Toy Wheel	\$10/100	—
2" Toy Wheel	\$17/100	—
Axel Pegs	\$4/100	—

Great Buys!



	Qty.	Cost
3/8" x 36" Standard Dowels	\$21/100	—
3/4" x 36" Oak Dowels	\$15/10	—
3/8" Maple Buttons	\$2.15/100	—
1/2" Maple Buttons	\$2.25/100	—
1-1/2" Maple Spindles	\$9/100	—
2-1/8" Maple Spindles	\$18/100	—

ORDER NOW

MC/Visa Check Enclosed

Total Cost _____

Handling **\$3.00**

Ohio residents add 5% sales tax

Final Cost _____

MC/Visa Number _____

Expires _____ Phone _____

Name _____

Address _____

City/State/Zip _____

FREE 16-PAGE CATALOGUE

Circle this section for FREE Dowels — mixed pack, Maple, Oak, Walnut Cherry, from 1/4" up to 1" Approximately 10 LFT. 14" long. \$5.00 value with any order.

MIDWEST DOWEL WORKS

4631 Hutchinson Road
Cincinnati, Ohio 45248
(513) 574-8488

Same Day Service/Order before Noon
Factory Direct/Satisfaction Guaranteed

READER SERVICE NO. 50



**ORDER TOLL FREE
1-800-235-0272**



90-C103

READER SERVICE NO. 16



ARROWMONT
School of Arts and Crafts
Box 567, Gatlinburg, TN 37738 (615) 436-5860

**One and Two Week Workshops
JUNE 4 - AUG. 10, 1990**

WOOD: Addle Draper - Bud Latvin, Liam O'Neill, Michael Hosaluk, Del Stubbs, Rich Sullivan, Christopher Weiland, Bruce Mitchell, David Elsworth/CERAMICS/FIBER-FABRIC/METAL/STAINED GLASS/PAPER/DRAWING/PAINTING/PHOTOGRAPHY

Graduate/Undergraduate Credit
Assistantships/Scholarships
Year-Round Gallery Exhibition Schedule

READER SERVICE NO. 6

**Sleeveless
DRUM SANDER**
Uses regular sandpaper—no pre-made sleeves to buy!



Lifetime Guarantee

USE ON:
Drill press, motor, lathe, combo-tools, radial saw, drills.

Twist of key tightens sandpaper to drum. Rubber backing insures long sandpaper wear.

1" x 3" long	\$14.95
2" x 3" long	\$16.95
2 1/2" x 3" long	\$17.95
3" x 3" long	\$18.95
1" and 2 1/2" above	\$29.95
Set of 4 above	\$59.95
3/4" x 3" long	\$15.95
2 1/2" x 4 1/2" long	\$22.95
3" x 4 1/2" long	\$24.95
2 1/2" x 6" long	\$27.95
3" x 6" long	\$29.95

AVAILABLE WITH:
*1/2" bore with 1/2", 3/8", or 1/4" shaft
*1/2-20 RH threads (except 3/4" x 3")
*3/8" bore (except 3/4" x 3" and 2" x 3")

MC, Visa, Check or Money order to:
SINGLEY SPECIALTY CO. INC.
P.O. BOX 5087F, GREENSBORO, N.C. 27403
CALL: (919) 852-8581

READER SERVICE NO. 93

QUALITY HARDWOODS
Clear • Kiln Dried • Surfaced 4 Sides • 3/4" Thick
3" to 10" Widths • 2-Ft. to 7-Ft. Lengths
20 Sq. Ft. Packs • Random Widths & Lengths

Red Oak - Plain	\$45.00
White Oak	\$44.00
Pecan	\$42.00
Cherry	\$59.00
Walnut	\$60.00
Hard Maple	\$33.00
Ash	\$49.00
Basswood	\$31.00
Poplar	\$27.00
Aromatic Red Cedar (Tight Knots)	\$32.00
Cypress	\$31.00
Birch	\$43.00

Orders Shipped C.O.D. by UPS. Shipping Charges Added.
Texas Residents Add 7% Sales Tax.

**To Order Call 214-693-4735 or Write to:
K & S SPECIALTY LUMBER**
P. O. Box 125 - Hill's Lake Road - Carthage, TX 75633

READER SERVICE NO. 89

**The Japan
Woodworker's
Catalog is . . .**

loaded with the best tools you can get your hands on. In our catalog you will find a huge selection of Japanese saws, waterstones, chisels, planes, carving tools, cutlery and books. Send \$1.00 for our catalog and supplements during the next two years.

THE JAPAN WOODWORKER
1731 Clement D3, Alameda, CA 94501
Phone 1-800-537-7820

READER SERVICE NO. 155

Do you spend more time setting up a dovetail jig than you do cutting the dovetail joint?

Don't give up on dovetails. If dovetailing is time-consuming or a hassle, you don't need more frustration.

You need a better dovetail jig:
The KELLER DOVETAIL SYSTEM.

Now, NEW MODELS with expanded capacities.

"In a class by itself." — *WOOD Magazine*

"Easy to use. Ruggedly constructed."
— *FINE WOODWORKING*

"An absolute minimum of set-up fiddling — less than any other jig tested. The jig is simplicity itself."
— *AMERICAN WOODWORKER*

Fast set-up. No test cuts. Unlimited widths. Precision joinery. Classic and variable spacing. Compound angles. Box joints. 20-year warranty. Made in USA since 1976.

To find out more, contact your Dealer or
KELLER & CO. Dept. F10
1327 T St., Petaluma, CA 94952
(707) 763-9336

KELLER DOVETAIL SYSTEM
The quiet revolution in dovetailing.
Join it.



READER SERVICE NO. 39

Mini Max Lets You Make Short Work Of Tall Orders

With dependable Mini Max machinery, you can tackle a wider range of projects than ever before. Our rugged lineup delivers industrial caliber performance and outstanding quality at attractive prices.

- L55 Stroke Sander: cuts an 8 hour hand sanding job down to 1 hour
- T124 Copy Lathe: the simple essence of much more expensive copy lathes
- S45 18" Bandsaw: big bandsaw performance at half the cost
- FS35 13 1/2" Jointer Planer: change over in seconds to do all four board sides
- T3T Sliding Table Shaper: a compact heavyweight for superior surfaces

Call today for the name of your nearby distributor. We'll help you take your ideas all the way.

5933 Peachtree Industrial Blvd.
Suite A, Norcross, GA 30092
(404) 448-1120 FAX (404) 448-6041



MiniMax
READER SERVICE NO. 58
A Division of **scmi**

TOOLAND, INC

1-800-446-6255

VISA
MASTERCARD

ALL ORDERS SHIPPED UPS/FREIGHT, PREPAID (CONTINENTAL USA) EXCEPT HITACHI F1000A. SALE PRICES LIMITED TIME ONLY AND SUBJECT TO CHANGE WITHOUT NOTICE. WE CAN ACCEPT VISA, MASTERCARD, MONEY ORDERS, PERSONAL CHECKS. SORRY WE ARE UNABLE TO SHIP C.O.D.

1662 BROADWAY, REDWOOD CITY, CA 94063

Porter Cable
5116

OMNIJIG **\$265.00**
BOSCH Dovetail Template Kit
#82912 **\$89.00**

Porter Cable
Dovetail Template
#5008 **\$79.00**

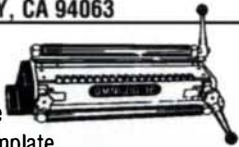

PORTER CABLE

555 Plate-Jointer
\$159.00
With kit (1000 Biscuits
& steel case) **\$186.99**

100 7/8 H.P. Router	\$93.00
690 1-1/2 H.P. Router	\$120.99
691 1-1/2 H.P. Router	\$137.99
D-handle	\$137.99
536 Speedmatic Router	\$193.99
537 D-handle Speedmatic Router	\$204.99
693 Plunge Router	\$159.99
6931 Plunge Base	\$79.99
696 Router Table	\$117.99
97310 Laminate Trimmer Kit	\$189.99
7334 Swirlaway Orb Sander	\$119.99
330 Speed Bloc	\$54.00
505 1/2 Sheet Sander	\$102.00
345 Saw Boss	\$99.00
9345 Saw Boss Kit	\$119.00
352 3" x 21" Dustless Belt Sander	\$127.00
360 3" x 24" Dustless Belt Sander	\$179.00
362 4" x 24" Dustless Belt Sander	\$184.00
9850 Cordless Drill Kit	\$127.00
7548 V.S. Orbit D-handle Jig Saw	\$123.00
9629 V.S. Orbit Tiger Saw	\$144.99
9647 V.S. Tiger Cub	\$114.99
9314 Trim Saw Kit (Steel Case)	\$144.99
621 3/8" Heavy Duty Drill	\$89.99
7514 1/2" Heavy Duty Drill	\$109.99
367 3-1/4" Planer	\$149.99
320 Abrasive Planer	\$109.99
9118 Porta Planer Kit	\$189.99
7312 Offset Laminate	\$119.99
310 Laminate Trimmer	\$129.99
7310 Laminate Trimmer	\$84.99

BOSCH

V.S.V. Orbital Jig Saw	
1581VS	\$130.00
With Carrying Case	\$154.99
1582VS Jig Saw	\$124.99
3270D 3" x 21" Dustless Sander	\$128.00
1272D 3" x 24" Dustless Belt Sander	\$169.00
1273D 4" x 24" Dustless Belt Sander	\$179.00
1273DVS V.S. Dustless Belt Sander	\$189.00
1942 HEAT Gun	\$69.99
1632ZVSK V.S. V.O. Recip Saw Kit	\$129.99
3258 Planer with Carbi Blade	\$124.99
Kit (Case and Dust Bag)	\$139.99
1604 1-3/4 H.P. Router	\$119.00
Kit (Steel Case, Router Bit, Case & Straight Guide)	\$154.99
1611 3 H.P. Plunge Router	\$195.00
1611 EVS V.S. Plunger Router	\$229.00
1609K Trimmer Kit	\$164.00
91064 3/8" Mighty-Midget Drill	\$99.00
91066 1/2" Mighty-Midget Drill	\$189.00
1198 VSR 1/2" Hammer Drill	\$139.99
1198 VSR K (Kit w/Steel Case)	\$159.99
T4004 7 Pc. Brad Point Drill Bit Set (1/8", 3/16", 1/4", 5/16", 3/8", 7/16", 1/2")	\$12.00

20% OFF ON ALL BOSCH FORSTNER BITS
1347 4-1/2" Mini Grinder **\$89.99**

30% OFF ON ALL BOSCH ROUTER BITS

PANASONIC

EY503B Cordless Screw Driver	\$59.99
EY571B Hi-Torque Keyless 9.6V	\$134.99
EY551B 7.2V Cordless Driver Drill	\$64.99
EY574 B 9.6V Cordless Impact Driver V.S.	\$169.99
New 15 Min. Fast Charging System 9.6V, EY6281B 2 speeds Variable	\$194.99
12V EY6205B 2 speeds Variable	\$209.99

RYOBI

10" Portable Planer AP-10	
Freight Included	\$359.99
JP155 New 6" Jointer	\$309.99
L120UK 3-5/8" Planer Kit	\$92.00
R500 2-1/4 H.P. Router Kit	\$157.00
TR30U Laminate Trimmer	\$79.00
S500A 1/6 Sheet Sander	\$35.00
BE321 3" x 21" V.S. Belt Sander	\$128.00
EZ1380 1/2" Cordless Drill	\$139.99
EZ1320 Cordless Screwdriver	\$64.99
HBSE75S 3" x 21" V.S. Belt Sander	\$159.99
V-2.5 WD Shop Vac	\$159.99

SYSTI MATIC

Carbi 1705 6 In. Dado Set	\$109.99
Carbi 1660 10" x 40T Miter Saw Blade	\$44.99
Carbi 1840 10" x 55T Combination Plymaster	\$49.99
Carbi 1910 10" x 60T Finishing Blade	\$59.99
Carbi 1430 10" x 80T Finishing Blade	\$74.99
Carbi 1250 10" x 100T Finishing Blade	\$84.99
Carbi 1235 10" x 80T Thin Kerf Finishing Blade	\$79.99
Carbi 1160 15" x 100T Thin Kerf Finishing Blade	\$129.99

20% OFF on Systi Matic Carbi Saw Blade on item not listed call for price

EMGLO Compressor

EMGLO Compressor	
AM39-HC4V 3/4 HP	\$275.00
AM78-HC4V 1-1/2 HP	\$299.00
AM78 HC4 1-1/2 HP	\$299.00

HITACHI

TR12 3H.P. 1/2" Plunge Router	\$169.99
With Case	\$189.99
M12V New 3-1/4 H.P. V.S. Plunge Router	\$259.99
F20A	\$97.00
TR8	\$117.00
TR6	\$93.00
C15FB 15" Miter Saw (Saw Only)	\$379.99
15" H.S.S. Blade	\$39.99
15" x 100T Carbi Saw Blade	\$99.99
C10FA 10" Miter Saw	\$284.99
C8FB Compound Saw	\$469.99
With Extension & Vise	\$494.99
8-1/2" x 40T Thin Kerf Carbi	\$39.00
8-1/2" x 60T Thin Kerf Carbi	\$49.00

THE SANDER WITH STRONG APPEAL

POWER
For Abrasive Planing

PRECISION
For Flawless Sanding

SPEED
For Production Woodworking



Made In U.S.A.

SUPER-MAX Heavy Duty Drum Sander

The efficient design of the Super-Max combines the proven features of the Performax S/T Drum Sander and the Power Feed with a 5 HP motor and a heavy duty stand for the most affordable drum sander of its size.

The patented, self-cooling, sanding drum has built-in sandpaper fasteners for quick and easy sandpaper attachment without adhesives or tape.

The innovative Power Feed uses an abrasive conveyor belt for a hard, non-slip surface for precise sanding and a consistent feed rate. These exclusive features will uniformly sand veneers and boards as short as 2-1/4".

Performax Products offers a complete line of affordable and efficient drum sanders for use in cabinet shops, home workshops, custom furniture shops and in musical instrument making.

For a Free Brochure or the Dealer Nearest You Call or Write to:

PERFORMAX PRODUCTS, INC.

1-800-334-4910
12211 Woodlake Dr., SF, Burnsville, MN 55337

READER SERVICE NO. 53

NEW

AMERICAN MADE, HEAVY DUTY!

DRUM SANDER

Sand boards, frames, doors, veneer, knots, wild grain perfectly flat and smooth **every time!**

Reduce sanding time from hours to minutes!

Delivers sanding precision equal to large wide belt sanders at an affordable price!

This is the best drum sander in the world. It has quality features not found on other brands. Let us prove it to you. Contact your local dealer or the factory today!

PLEASE SEND ME A FREE BROCHURE
Telephone orders (417) 223-4031
Ross Industries Dept. FA-12
100 North Highway W, Box 637, Pineville, MO 64856

ROSS INDUSTRIES INC.

Name _____

Address _____ Phone _____

City _____ State _____ Zip _____

READER SERVICE NO. 61

Production Chairmaking

Jigs and loose tenons simplify angled joinery

by Terry Moore

Chairmaking seems to intimidate many an accomplished craftsman. I must admit, I shied away from all that angled joinery for years. However, my fears subsided when I eventually realized that people were buying someone else's chairs to go with my tables and desks and there was a risk that those chairs might detract from the beauty of my work. My other consideration was financial: I was losing money by letting all the chairmaking work go to other craftsmen.

Fussing with the angled joints in a typical chair can be a costly chore for many builders, but I simplified the process by basing the joinery on loose tenons, as shown in figure 1 on the facing page. After the parts are shaped, I cut mortises in both halves of each joint, and then join the two pieces with a loose tenon. Angled mortises are easily and accurately cut on the slot mortiser, once it's fitted with a wedge-like fixture, as shown in the top photo on p. 42; the loose tenon stock is ripped out on the tablesaw and the edges rounded over with a router bit. The joints are strong and don't require a lot of hand-fitting. However, the real beauty of this system is that it doesn't constrain my design creativity. Since even the most complicated angled joints can be easily made, my hand is free to design the form most appealing to my eye.

Writing a plan—Before beginning construction, I make full-size drawings of my chair and mentally formulate a preliminary step-

by-step construction plan (see the sidebar on p. 45). I outline each step, including preparing the stock, cutting parts to length, mortising, milling tenon stock and assembling the piece, trying to anticipate any possible construction problems. I further refine my plan and modify procedures as needed when I build a prototype of the design. Once I'm actually ready to manufacture the set of chairs, most of the thinking work is finished and nearly all dimensions and angles can be picked up from the full-size drawing without using a ruler.

I begin production by planing, jointing and ripping stock for all the legs, seat rails and backs, as shown in figure 1. Extras of each part are prepared to avoid having to reset machines to remake damaged or defective pieces. Except for the profile shape of the back legs, I leave all parts square and parallel until the joints have been machined.

The 1½-in.-square blanks for the front legs are simply ripped and planed from ¾ stock and crosscut to 17 in. using a miter gauge on my tablesaw. Stock for three of the seat rails on each chair is ripped and planed 1½ in. by 2½ in.; the back seat rail is cut 1½ in. by 3¼ in., wide enough to cover the back edge of the seat cushion. The stock for each crest rail and intermediate rail is planed on one side and jointed to 1¾ in. by 2½ in. Using a plywood pattern, lay out as many pairs of back legs as possible on a single piece of 1½-in.-thick stock. By choosing the widest stock available, you can orient the pattern so the grain follows the leg's shape and still make the most economical use of the board. The "waste" from cutting the back legs may be used later for back slats, thus ensuring that the grain and color will match throughout.

Shaping from patterns and jigs—Working with patterns and jigs eliminates the need to measure, so I can almost put my ruler away. The back legs, for example, are laid out with a ¼-in. plywood pattern, shown in figure 2 on p. 42, which was taken from the full-scale drawing. The pattern has a mark that, when transferred to the stock, aligns the roughsawn leg to my profile shaping jig (shown in the bottom photo on p. 42). After bandsawing the legs to within ⅛ in. of the pattern line, I clamp them in the profile jig and run the assembly over my shaper to finish the curve shown in the drawing.

The shaper operation is straightforward. The jig holds the roughsawn back leg securely, while the jig's front edge, which is actually a profile template of the finished leg, follows a guide collar fit in the shaper's table. As the jig's template is run across

Photo: Thomas Ames, Jr.



The curved lines of this trestle table are complemented by the walnut chairs that Moore built with a series of jigs.

Fig. 1: Chair plans



Fig. 2: Patterns for back legs

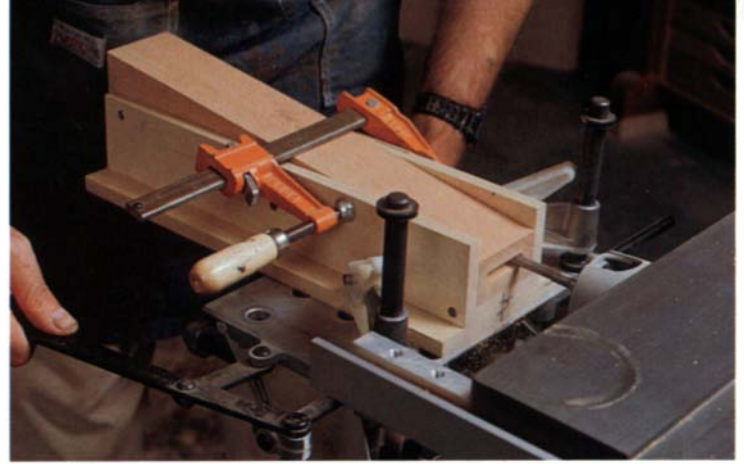
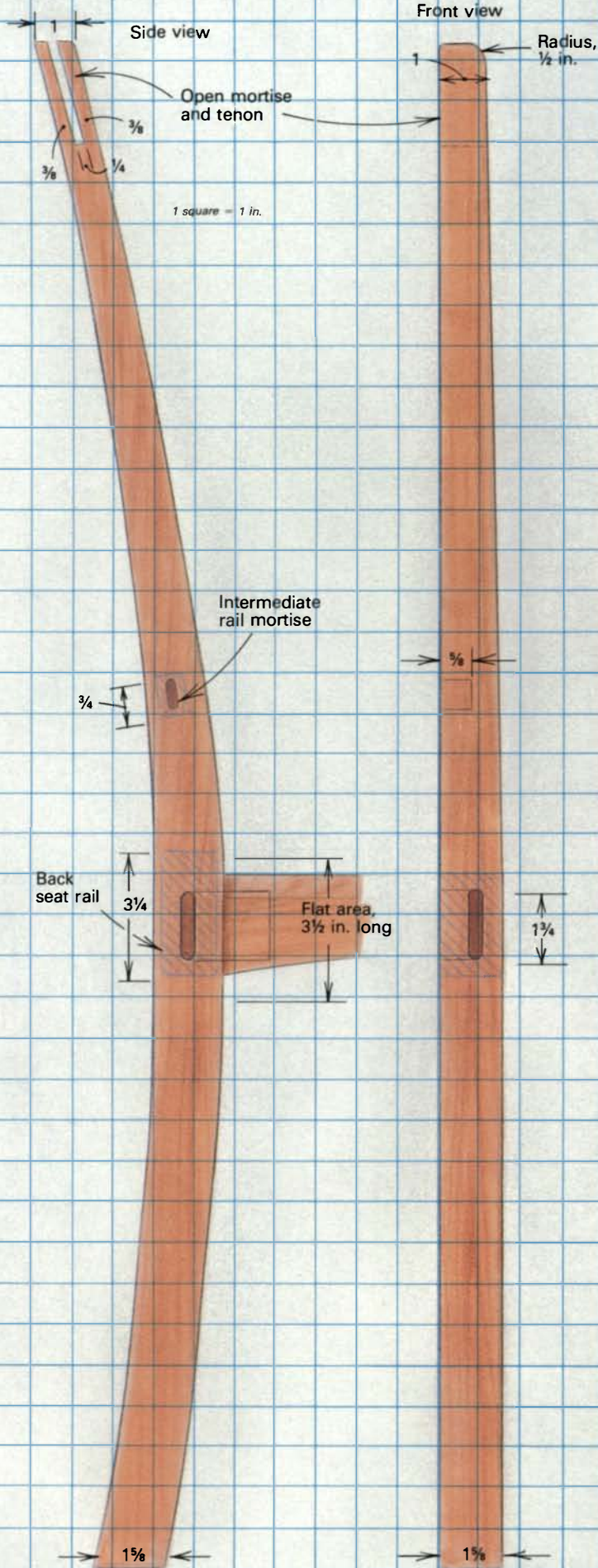

To cut angled mortises on the ends of the side rails, the author equips his slot mortiser with the auxiliary fixture shown. Note how the centerlines of the fixture and table align during the cut.

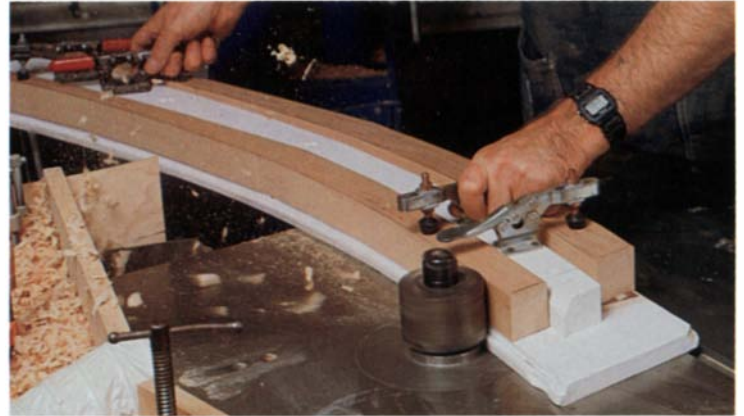

To shape the back legs, Moore clamps both roughsawn pieces to a jig that rides on the stationary collar in the shaper. The guard has been removed for the photograph.

the collar, the shaper's straight cutter precisely finishes the leg's profile. Because my shaper's collar is smaller than the cutter, the jig template must be larger than the finished back leg. If you don't have a shaper, you can clamp the back leg in a vise and shape it with a 2½-HP to 3-HP router using a straight bit and bearing that follows a template.

A back leg sizing jig, which looks a lot like the back leg shaping jig, is clamped to the fence on my radial-arm saw to secure the rear leg at the proper angle while it's cut to length.

Angled tenons and straight mortises—My mortising system, which is based almost entirely on machines, relies on 90° mortises cut in legs and loose tenons fit into angled mortises in side rails. Gluing these tenons into the rail mortises in effect creates an angled tenon that is very strong because it doesn't have any weak, short grain areas possible on tenons cut at an angle. Both leg and rail mortises are cut to the same width on my Inca slot mortiser (available from Garrett Wade, 161 Ave. of the Americas, New York, N.Y. 10013; 800-221-2942, in N.Y. 212-807-1757), although other mortising machines or a router will work. Since the mortises are cut to uniform width and depth, tenon stock can be milled to uniform thickness and width and rounded over with a router bit. For strength, the tenons meet in a miter, shown in the loose tenon detail in figure 1 on the previous page, which strengthens the joint more than one long and one short tenon would.

Once I've laid out the first mortise of each batch of parts and set up the machine, my job is similar to that of a production worker. When you get the first rail of a batch to fit accurately, the rest are easy. The mortises are laid out on the rail ends with a 3/8-in. shoulder at the top, bottom and outside, and a 5/8-in. shoulder on the inside. The mortising of the front and back legs and front and back

rails, which join the legs squarely, is done directly on the slot mortiser table, which is set at 90°. I use an auxiliary side rail fixture, which is shown in the top photo on the previous page, to align each end of the side rails to mill 7° angled mortises. The side rail mortising fixture is quicker to set up and more accurate than changing the angle of the mortiser table. The rail fits snugly on the fixture's 7° bed, which supports the rail so its end is perpendicular to the cutter. After aligning the centerline on the fixture with the centerline on the table and clamping the fixture in place, the mortise width is set with the table-movement-limit levers. The table height can then be adjusted and the first side rail mortise bored.

The 1/8-in.-deep leg mortises are laid out by holding the appropriate seat rail in position on the leg, tracing the outline of the rail and then marking the mortise. The mortise should be located about 3/8 in. from the top of the front leg and 1/2 in. from its outside face; this will set back the side and front rails about 1/8 in. Finally, mark the centerline of the back leg mortise, as shown on the three legs in the left photo at right, so you will be able to align the pieces on the mortiser table. Clamp the first leg to the table and adjust the stop collars in the mortiser table's surface so the remaining legs in the series can be accurately placed on the table. Then with the handwheel, set the table height in relation to the cutter, but leave the mortise width set the same as for the rails. After making sure the seat rail tenon fits the first mortise, you can mortise the remaining legs with the same setup by simply marking and aligning the mortise centerline.

After mortising the front and back legs and all four seat rails, I taper the front legs and cut and shape the curve in the bottom of the seat rails, as shown on the patterns in figure 3 below. The straight tapers on the front legs are rough cut on the tablesaw, with a taper jig, and cleaned up on the jointer. Curves in seat rails are bandsawn from patterns and finished on the spindle shaper with jigs.

Chair backs and crest rails—The crest and intermediate rails are curved to conform to the roundness of the human back. Before sawing them to shape or cutting mortises in these rails for vertical back slats, I set up the tablesaw and cut the open mortise-and-tenon joint on the rail ends and on top of the back legs (see figure 1 on p. 41).

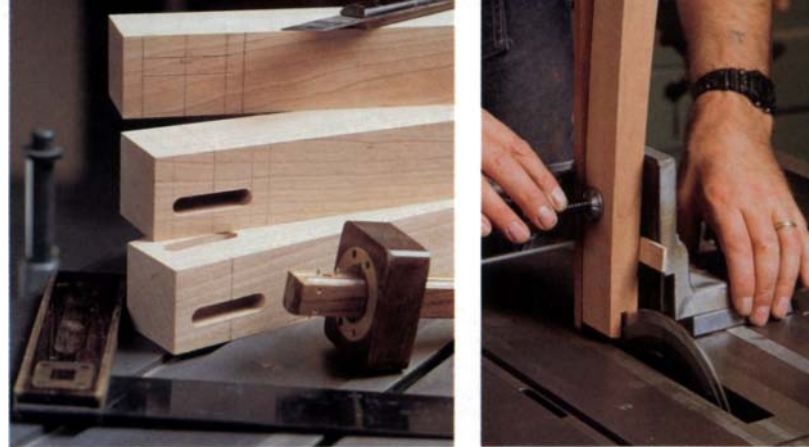

Left: Slot mortising is simple after careful preparation on the first leg (top). Moore has laid out the mortise on the joint's centerline. After cutting one (middle) and checking its fit, he can mortise the remaining legs by using only a centerline for reference (bottom).

Right: The author cuts the 1/4-in. open mortise in the top of the back leg with a tenon jig on the tablesaw. After squaring the leg's end to the table, a shim is temporarily taped to the jig to align the remaining legs.

I use the tablesaw tenon jig and a dado blade to cut both back leg mortises as well as the shoulders on the crest- and intermediate-rail tenons. I set the blade 90° to the table and angle the back leg in the tenon jig to cut the open mortise parallel to the front of the back leg. Use a try square to check that the front line of the crest rail mortise is perpendicular to the saw's table, and tape a shim to the tenon jig, between it and the leg, as shown in the right photo above. If the setup is correct, cut the mortises in the top of all the back legs.

Then, in order to cut straight, parallel tenons on the crest and intermediate rails, remove the shim and reset the jig. Since the crest rail stock is still straight and unshaped, it's simply clamped in the jig perpendicular to the saw's table. You can eliminate considerable handwork and ensure that each intermediate rail will be of uniform curve if you use stock wide enough for two rails. I simply cut both crest rails and intermediate rails to the same dimensions, and then cut a single, continuous tenon on both ends of the stock; later I rip an extra crest rail in half to

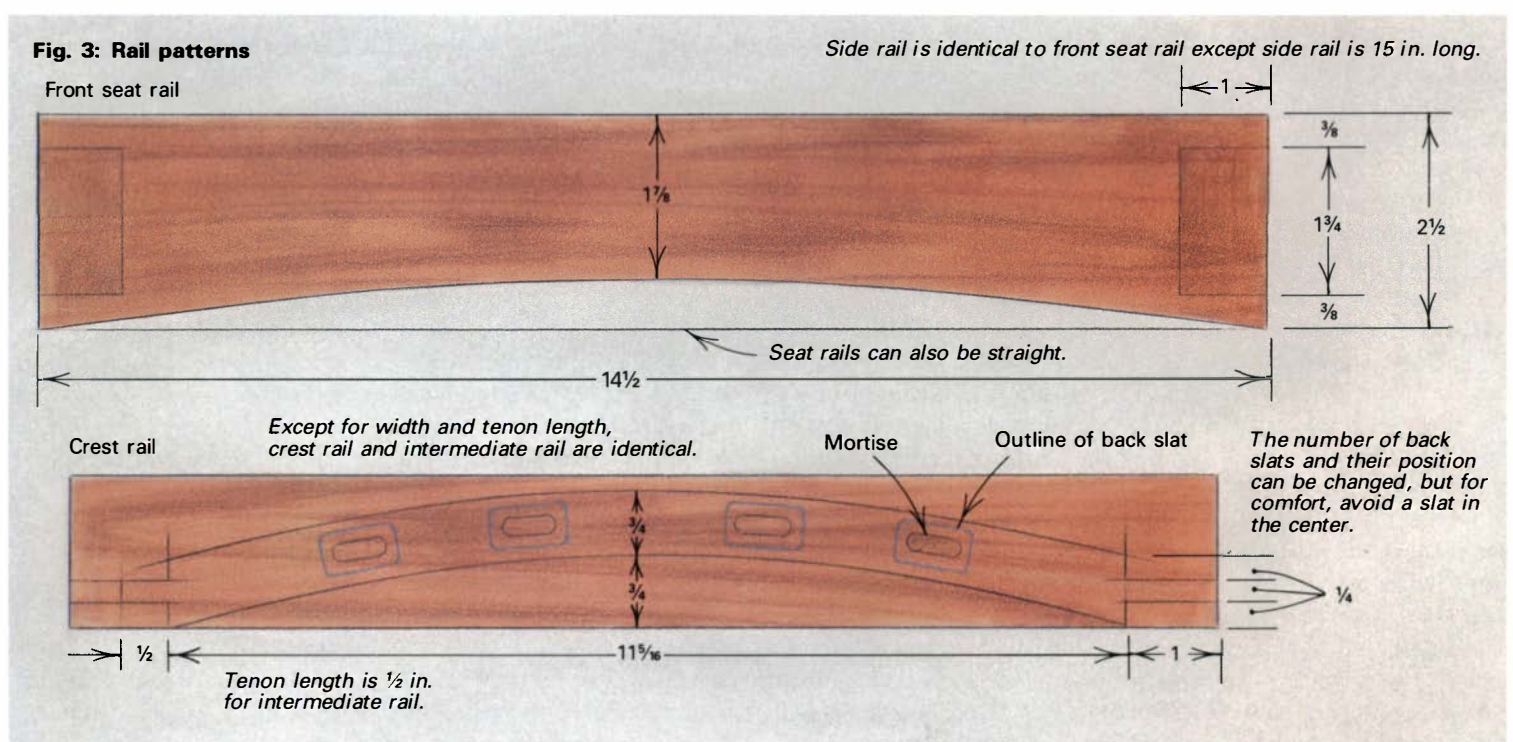

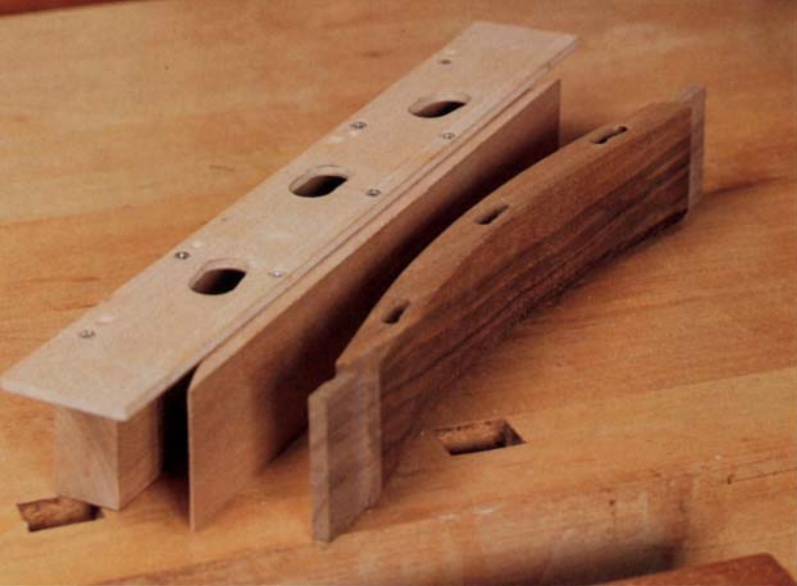

The author mortises the crest and intermediate rails to accept the back slats with this simple plunge-router jig. Each shaped rail is fit into the curved slot in the jig and the whole assembly is clamped in a vise; the slots shown guide the router's collar during the cut.

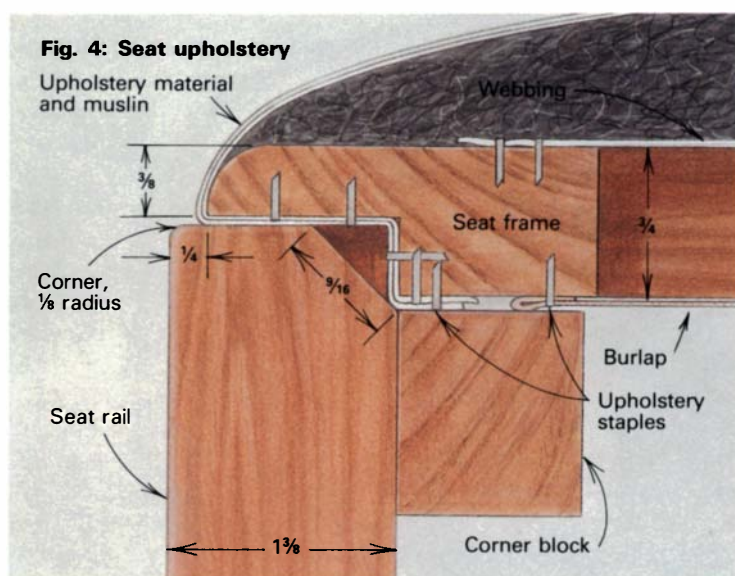

produce the two intermediate rails.

Next, lay out the curve in the crest and intermediate rails from the pattern in figure 3 (see the previous page) and bandsaw them to shape. After sawing to the line, I use a compass plane to true up the front, concave curve and a smoothing plane to finish the back, convex curve before scraping and sanding. Then I rip intermediate rails from crest rail stock, and cut their tenons to $\frac{1}{2}$ in. long by $\frac{3}{4}$ in. wide, with a $\frac{1}{8}$ -in. shoulder on the top and bottom. In each case, check the first tenon's fit in a leg mortise before cutting the rest of the tenons. Leave the crest rail tenons full width.

Mortises on the inside of the back legs, for intermediate rails, are cut with a plunge router and a $\frac{1}{4}$ -in. straight bit guided by a slot cut in the leg profile pattern. To shape the outside of the rear leg, which tapers from the top of the seat to the top of the leg, I trace the pattern, shown in figure 2 on p. 42, rough-cut the shape on the bandsaw and finish with jigs on the spindle shaper.

Back slat tenons and their mortises—I use a plunge router and simple jig to plunge-cut the mortises in the crest rail and intermediate rail to accept the stub tenons on the back slats. The router jig, shown in the photo above, registers and holds the curved crest and intermediate rail stock, while the router's collar is guided by the holes in the jig's thin plywood template. Locate the collar in the hole, and plunge a $\frac{1}{4}$ -in. straight bit into the rail as you move the bit in the

slot and gradually plunge-cut to the $\frac{1}{2}$ -in. mortise depth.

The back slat tenons must be angled—about $1\frac{1}{2}^\circ$ for the intermediate rail and $4\frac{1}{2}^\circ$ for the crest rail. To measure these angles, dry-assemble the back legs, intermediate rail and crest rail; then, hold a straightedge against the rails at the chair's centerline and set a bevel gauge to the angle between the rail edges and straightedge. I cut the tenons in one pass on the spindle shaper, which is set up with two straight $\frac{1}{2}$ -in. cutters separated by a $\frac{1}{4}$ -in. spacer. The stock is supported during the cut by a sliding-table jig that rides in the table's slot. Begin with stock that is wide enough for multiple slats and cut the pieces to length. Wedge up the tail end of the stock in the jig until the end to be cut is at the proper angle to the cutter, and then clamp the stock against the jig's fence. Once a continuous tenon is cut in both ends of the back slat stock, the stock is ripped into multiple slats, which are rounded over and finished.

After the mortising and shaping is done, I crosscut and miter the loose tenon stock to length and glue the pieces into the rail mortises.

Assembling the chair—Before assembly, I round over all corners with a $\frac{1}{8}$ -in. radius bit, sand and carefully apply a sealer coat of Watco oil (available from Minwax Co., 102 Chestnut Ridge Plaza, Montvale, N.J. 07645), making sure not to get it on joint surfaces. Sealing with oil helps keep parts free of glue during assembly.

A systematic approach to assembly is a must. After a dry run to check the joinery for fit, I glue up the 90° joints first, which are the front and back subassemblies. The front subassembly is the two front legs and the front seat rail and the back subassembly is the two back legs, back seat rail and intermediate rail. The crest rail and back slats, because of the open mortise-and-tenon joint at the top of the back legs, are added later. Try to match wood color and grain during assembly and clean up glue with a damp rag as you go.

When the glue has dried, dry-fit the front and back subassemblies together with their side rails. Pare shoulders and tenons as needed to ensure a good fit and then gather tools and parts for final assembly: two bar or pipe clamps, some clamp pads and a damp rag. Working on one chair at a time, I glue the side rails to the back subassembly and then the front subassembly to the side rails, working quickly so any needed adjustments can be made before the glue sets up.

The chair isn't complete until I have installed corner blocks on the inside of the seat rail frame and made a slip cushion seat frame, which will be padded and covered. Since my chairs are built of strong components joined with well-fit mortises and tenons, corner blocks serve only to secure the seat. Regardless, they are tight-fit and fastened to the inside of the seat rails with screws.

Traditionally, the seat is an upholstered hardwood frame with webbing and horse-hair padding, but I use a piece of well-padded $\frac{3}{4}$ -in. plywood on some chairs. For more on upholstering a seat, see *FWW* #79, pp. 78-81. I allow room for the fabric and padding, which is stapled to the underside of the slip cushion, by routing the inside of the seat frame, as shown in figure 4 at left, with a chamfering bit. While I apply the oil to the chair frame, I send the slip seat frame out to be upholstered.

Finally, place the chair on a flat surface, check if it sits flat on all four legs; if one leg is long, mark it and cut or sand it to length. Now you're ready to rump test it and move on to the next chair or set of chairs. □

Terry Moore was brought to Newport, N.H., from Wales, Great Britain, as his wife's "souvenir" 15 years ago. He's been a cabinetmaker and furnituremaker there ever since.

Designing a chair

Fig. 5: Straight-line sketch

Dimensions are parameters for comfortable dining chairs.

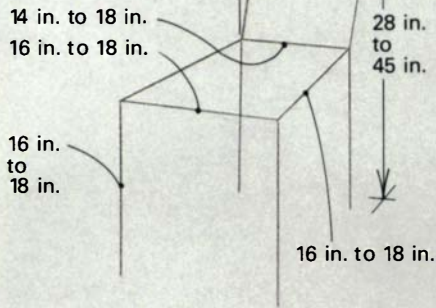

When I set out to develop this chair series, it was not my intention to design something new or flashy. I simply wanted to develop a sound construction process that would leave the final design of the chair variable. When designing chairs, you must reconcile comfort, strength and aesthetics, but my foremost consideration is comfort. After all, if a chair isn't comfortable, its design fails. Secondly, it must be strong and durable, or it will fall apart. And if the chair isn't attractive, nobody will want it in their home. All three aspects are important and must be dealt with.

I studied dining chair comfort by analyzing and critiquing many different types of chairs and querying other adults of various sizes about their comfort requirements. The results of my research are the parameters listed for the chair in figure 5 above. The height of the back, often an aesthetic consideration, can be as little as 28 in., as in a Sam Maloof type low-back chair, or as great as 45 in., as in a Charles Rennie Mackintosh type high-back chair. My dining chairs have higher-than-average backs to provide comfort and upper-back support when reclining after a meal.

Once I established basic seat dimensions, I studied how other chairmakers blend comfort with aesthetics and sturdy construction. Excellent sources of information and inspiration were museums and galleries. I brought a measuring rule and notebook and remembered to ask permission before taking measurements. Taking special note of what I liked and disliked about a particular design, I tried not to be intimidated by what I saw while making rough sketches of designs and noting construction details.

At the drawing board: With sketches in my notebook and ideas fresh in my head, I drew simple, straight-line sketches, such as those in figure 5. Once I liked the basic dimensions, I refined the lines so the chair would blend with its accompanying table. Then I worked the simple sketches into detailed, measured drawings, like those in figure 1 on p. 41, with side and front elevations and a plan of the seat, along with any curvature designed into the back. At this point it's not necessary to draw many construction details, except you must remember to provide enough wood for joint construction and to show joints that will be visible, such as the open mortise and tenon at the top of the back legs in figure 1.

The crest rail, along with the space beneath it and the seat, is the designer's focal point of the chair. The chairs in the photo below are from the same design series, but each have different backs. In each successful variation, every aspect of the design must blend together to convey consistency.

Full-size drawings and prototypes:

My last design steps are to draw the chair full size to show the front, side and plan views as well as joinery details. Full-size drawings have X-ray details of joints; unless I need to visualize construction details, I don't bother with perspective drawings.

Before building a prototype, I pick up pat-

terns, dimensions, angles and joinery details from the full-size drawings, as well as information to design jigs and fixtures that make construction faster and more accurate.

I build the prototype from oak with the exact dimensions and joinery details as shown on the full-scale design. The chair isn't a mock-up, built of glued-together cheap material; it's identical to finished chairs in every detail, so it becomes a tool for working out assembly details. I use the prototype's disassembled parts to set up machines for difficult cuts and to test my assembly procedures. Once the prototype is assembled without glue, I can see and sit on a real chair and affirm whether the design does or doesn't work. This is my last chance to make changes before beginning the production run. Once finished with a set of chairs, I save the knocked-down prototype as a model to show prospective customers and to refresh my memory when building the next set.

If the first chairs are comfortable, sturdy and attractive and if the design sells, the model can be changed and elaborated upon in future chair sets. Maintaining the same joinery details, I have changed leg and seat rail profiles, back heights, crest rails and other elements of a design series to produce different chairs that complement different table designs, such as the three chairs shown in the photo below. —T.M.



These chairs are from the same design series developed by Moore. Although each is different, they all share the same construction methods based on a series of shop-built patterns and jigs. The chair on the left is of Honduras mahogany, the chair in the middle is curly maple with rosewood inlay and the chair on the right is cherry with ebony back slats.

Fig. 1: Mortise jig

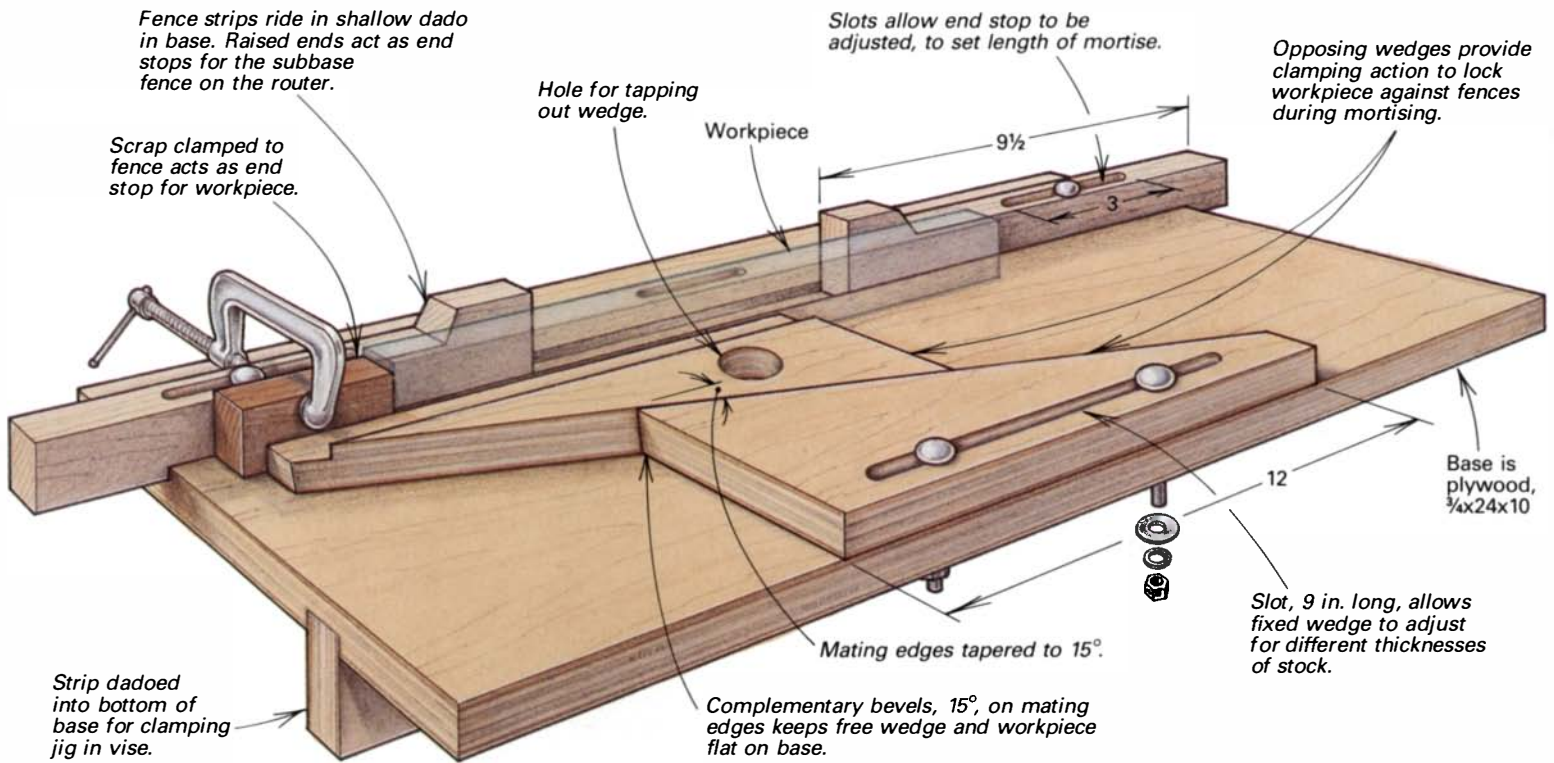

Machine-Made Mortises and Tenons

Production techniques for high-quality joinery

by Mark Duginske

Craftsmen have been joining pieces of wood together for centuries, always looking for a better way to do it. Our ancestors had to depend on interlocking joints for strength because their glues were not reliable. Dovetails were preferred for carcasses; mortise-and-tenon joints for frames. Today these joints are still favorites for high-quality work, but cost-conscious workers need economical ways to make them. Modern router jigs efficiently turn out miles of dovetails, but there's no comparable, low-cost machine for mortise-and-tenon production. So I decided to develop my own system for making mortises and tenons quickly and efficiently with shopmade jigs and standard machines found in most woodshops.

The mortise-and-tenon joint is ideal for frames of desks, chests of drawers, bookcases and cabinets of all kinds. Once a well-fit mortise-and-tenon joint is glued together, the mechanical contact and the large surface area of the mating faces make it very strong. Mortises and tenons are also great for joining stretchers to chair and stool legs, since the tenons' shoulders make the joint particularly resistant to racking. The joint's only real weakness is that the tenon can be pulled straight out of the mortise fairly easily, but this can be controlled by good gluing and, in demanding situations, a locking pin.

My joinery system is specifically designed for production with machines. A plunge router, fitted with an end-mill type bit and a special base, works in conjunction with a holding-and-referencing jig to cut slot-type mortises. The tenons are cut with both the tablesaw and bandsaw: shoulders are crosscut on a tablesaw, and then cheeks are ripped on a bandsaw equipped with an adjustable tenon fence. Finally, the tenons' square corners are chamfered to fit snugly in the rounded corners of the mortise (see the left photo on the facing page). One advantage of my three-machine system is that some setups can be fine-tuned independently of others. This allows you to go back and repeat a step, say if you accidentally mess up a cut.

Preparing the stock—The first step of my machine system is to rip all the frame stock to width and plane it to the same thickness. To ensure consistency and accuracy, every piece needs to be exactly the same thickness; otherwise it will be difficult to fit the tenons later. Also, make sure your planer's knives are parallel to the bed, or take the final pass over the same area of the bed. Next, cut all frame members to length, remembering to leave extra length on stiles or rails that will receive tenons. Be sure to cut a few extra



The author's system for cutting mortises and tenons, shown above, is based on three common shop machines: mortises are cut with a special plunge-routing fixture and tenons are cut accurately and efficiently with bandsaw and tablesaw setups. Shown at right, Duginske's shop-made mortise jig uses a pair of opposing wedges to firmly support the frame member on edge as the slot mortise is routed. The adjustable fence also features a set of stops, which limit router travel and hence the length of the mortise.

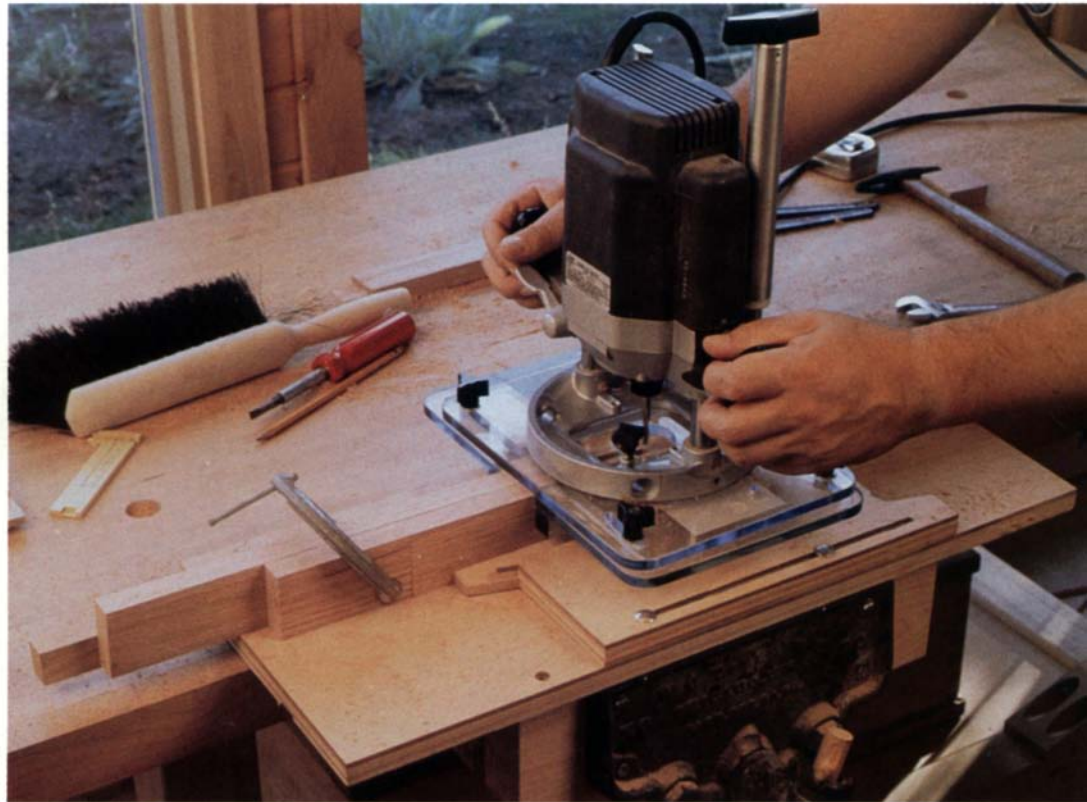

pieces of stock, which are later used to set up the jigs.

Traditionally, mortise-and-tenon joints are proportioned so the thickness of the tenon equals one-third the thickness of the stock; for instance, a 1/4-in.-thick tenon would be right for 3/4-in. stock. Likewise, the deeper the mortise, the stronger the joint because of the increased contact area between the two pieces. Usually on 2-in.-wide stock, I make the mortises 1 3/8 in. deep. Later, I cut the tenons 1 1/4 in. long, which leaves a 1/8-in. clearance at the bottom of the mortise. In this case, members with tenons on both ends need to have an extra 2 1/2 in. in length. On a narrow, 1-in.-wide frame, I would use a 7/8-in.-deep mortise and a 3/4-in.-long tenon.

Cutting mortises—My machine method follows the same order that is traditionally used for handmade joints: I make the mortise first, which is cut with the plunge router and end mill, and then cut the tenon to fit into the mortise. Since most routers are a little top-heavy, and this makes them hard to control, I replace the standard router base with a special auxiliary base fitted with two adjustable fences. These fences fit snugly on either side of the workpiece during mortising, to align the cut on the thickness of the stock and to stabilize the router atop the edge of the workpiece, allowing it to only move forward and backward. Although I have made bases out of wood, I now use a clear, plastic base and fence system made by Woodhaven, 5323 W. Kimberly Road, Davenport, Ia. 52806; (319) 391-2386. The clear base makes it easy to see alignment marks on the workpiece.

The mortise jig, shown in the right photo above and figure 1 on the facing page, holds the workpiece steady during routing and provides stops for limiting the cut of the router. It can be assembled in about an hour from pieces of scrapwood and a few nuts and bolts. The jig consists of a 3/4-in.-thick plywood base with a strip dadoed into the underside for clamping in a bench vise. A shallow dado in the top of the base holds two fences, and their inside ends serve as stops for the router base fence. Once the stops are set, the fences lock to the base with bolts riding in slotted holes. Two plywood wedges, each tapered and beveled at a 15° angle, secure the workpiece during mortising. One wedge is fixed, bolted to

the base via a slot, and the other wedge is free-moving. The tapered edges are driven against one another by tapping the free wedge with a hammer, forcing the workpiece against the fence. A hole in the free wedge provides a spot to tap, for separating the work after mortising. An end stop—a scrap the same width as the workpiece—is clamped or screwed to the router stop, to locate the end of the workpiece in relationship to the position of the router. Thus the distance between the mortise and end of the workpiece can be accurately set, for cutting corner joints. Only those frame members with mortises in the center need to be marked and positioned before mortising. In this case, I mark out the two ends of the mortise, put the router against one stop and then move the stock so one of the layout marks is aligned with the bit. After clamping the stock, I move the other stop to align the router bit with the second layout mark.

For efficiency, I follow a definite sequence in setting up the router and jig for mortising. First, I center the mortise, and then set the depth of cut of the router's bit; finally, the fence stops for the length of the mortise are set. The mortises must be exactly centered on the stock; it may take a little extra time setting up the fences on the router base, but you'll save time later when the tenons are made and fitted. The best way to check the position of the mortises is to make a plunge cut on one edge of a scrap piece, turn the piece over and make another plunge cut on the other side. When the cuts line up, the mortise is centered.

The router bit I use for mortising is a double-flute, "up-cut" end mill. This bit cuts on both the sides and the bottom, making a clean, slotted mortise. Flutes on an up-cut bit are similar to a drill bit: They pull the waste up and out of the cut. Although end mills are capable of taking up to a 3/8-in.-deep cut per pass, you'll get the best results with many small passes, perhaps taking 1/8 in. or less per pass. Move the router back and forth with a slow rhythmic motion and plunge slightly deeper on each pass until you reach the desired depth. Avoid heavy cuts: Overtaxing the bit can produce chatter or vibration that will leave the sides of the mortise irregular and rough and possibly cause bit slippage, which can rapidly wear the collet. The latter can not only cause too-deep

mortises, but, if the bit slips completely out of the collet, it can be dangerous. Keep an eye on this by placing an ink mark on the bit and the collet; if the marks move during mortising, the bit is slipping and it may be time to order a new collet. Also, a sharp bit has much less of a tendency to vibrate than a dull one. If you do a lot of mortising, you might consider using solid carbide bits instead of high-speed steel bits.

If you're using a variable-speed plunge router, you should set it to run at about 12,000 RPM. The slower speed, combined with taking light passes, is best for smooth, clean mortises—especially with a small bit, such as 1/4 in. dia., or with a particularly hard wood, such as maple. You should experiment on scrap stock before deciding on the best router speed.

The length of the mortise is now set by adjusting the mortise jig's stops. With my system, the mortise must be cut 1/4 in. shorter than the width of the tenon stock because of the way the tenons are trimmed later. In this case, the stock is 2 in. wide, so the mortise is 1 3/4 in. long. Once the stops are adjusted, you're ready to run your batch of mortises. When machining wider stock, such as chair or table legs, the router can slide directly on the edge of a single member. But when mortising narrower stock, such as 3/4-in. face frames, it's best to clamp two members side by side for a wider, more stable base for the router, to prevent it from tipping. After you've mortised all the necessary workpieces, mortise two extra scrap pieces for setting up subsequent operations.

Sawing the tenons—The tenons are made in three cutting stages. First, a shallow kerf is crosscut all the way around the end of the workpiece, to define the tenon shoulder. Second, the cheeks of the tenon, as well as the edges, are cut off. Finally, the edges of the tenon itself are chamfered to fit the round-cornered mortise. The shoulder cuts are made using the miter gauge on the tablesaw. I prefer to use a sharp crosscut or combination blade, which yields a crisp cut without tearout. The saw's rip fence is used as a stop for setting the length of the tenon, which is determined by the distance between the fence and the left edge of the blade. As a rule, you should not use the fence and the miter gauge together, but in

this situation you don't have to worry about a cut-off piece binding between the blade and fence. To assure a perfect tenon shoulder all the way around, square the miter gauge to the blade and set the fence parallel to the blade. Further, it's important for the face of the fence to be square to the table; otherwise, when you rotate the stock for the various cuts, the wood will contact different parts of the fence and the shoulder cuts won't match all the way around.

All four shoulder cuts are made with the blade at the same height, which is set as follows. Crosscut one of the extra mortised pieces through its mortise, place it next to the blade and set the blade to be about 1/32-in. higher than the wall thickness (see the left photo below). Rotate the blade back and forth to make sure you are setting the saw height with the tooth at top dead center.

After all the shoulders are cut, I cut the tenon cheeks on the bandsaw, which yields some distinct advantages over a tablesaw. First, the bandsaw blade's narrower kerf makes taking this power-hungry end-grain cut easier. Second, the cheeks are cut with the stock horizontal on the table; with a tenon jig, the stock sticks straight up, and the length of stock you can tenon is limited. Also, frame pieces don't need to be clamped to a jig, which saves time when cutting dozens of tenons. For accurate, repetitive cuts on the bandsaw, use a rip fence. If your saw doesn't have one, you can make the special rip fence, shown in figure 2 on the facing page, from wood scraps and carriage bolts. The face of this fence bolts to a subfence with wing nuts, which allows me to insert paper shims for fine-tuning the fence-to-blade distance and, hence, the thickness of the tenon. The subfence is bolted to a crosspiece that references to the edge of the bandsaw table, and it's attached to the table with a clamp. The crosspiece allows the angle of the fence to be fine-tuned for accommodating blade lead, the tendency of the blade to pull slightly one way or another during the cut. An adjustable stop, bolted to the fence through a slotted hole, allows you to set the depth of the tenon cuts. Although it doesn't make a great deal of difference what bandsaw blade you use, a 1/4-in. four or six teeth-per-inch (TPI) blade works well. The bandsaw must be properly adjusted for this technique to work. To prevent the blade from fluctuating sideways, the guides are actually placed in contact with



Above: A scrap piece of frame stock that's been mortised and cut through serves as a gauge for setting up the tablesaw blade for the crosscut that defines the tenon shoulder. The frame members are guided through the cut by the saw's miter gauge, while the fence acts as an end stop. Right: The tenon cheeks are bandsawn because it's easier to hold the stock horizontally during the cut, rather than vertically as with a tablesaw tenon jig. The tenon fence position, and hence the thickness of the tenon, is fine-tuned with dollar-bill shims.

the blade. I use cool blocks, which are non-metal replacement guide blocks containing a dry lubricant, to decrease the friction created by metal-to-metal contact. For more on bandsaw adjustment, see my article in *FWW* #75, pp. 75-77.

Set up the fence on the bandsaw, as shown in the right photo on the facing page, with the tenon between the blade and the fence, so as the cheeks are cut, the waste doesn't get trapped between blade and fence. Now use the scrap mortise as a gauge to set the fence-to-blade distance in the same way as you set the depth of the shoulder cuts earlier. With the mortise scrap against the fence, the blade should cut the first sample tenon about $\frac{1}{64}$ -in. oversize. Adjust the fence closer to the blade by inserting paper shims (I often use dollar bills for shims, because each one is 0.004 in. thick) between the fence halves and make another cut. Remember that the amount you move the fence will be doubled because you're taking that amount off each side of the tenon. Also, use a new piece of scrap for each new adjustment; if you use the previously cut piece, the bandsaw blade will deflect and you will not get a true reading. Ideally, the tenon should fit into the mortise with about 0.004 in. extra on each side, which is the thickness of a layer of glue.

After the face cheeks are done, trim the edge cheeks of the tenon back to the shoulder. This requires the fence to be reset so that the blade will take slightly more than $\frac{1}{8}$ in. off each edge of the tenon. To do the trimming, follow the same procedure as with cutting the face cheeks, described previously. Remove material until the tenon is about $\frac{1}{16}$ in. narrower than the mortise. In the case of a $1\frac{3}{4}$ -in. mortise, the tenon will be $1\frac{1}{16}$ in. This space enables me to fit the tenons by chamfering the corners rather than fully rounding the tenon.

Fitting the joint with bevel cuts—Since the tenon corners are square and the mortise corners round, the tenon won't fit until either the mortise corners are chiseled square or the tenons are rounded. After years of experimentation, I've decided that it's easiest to chamfer the tenons. The chamfers allow a small space between the flat surface of the tenon and round surface of the mortise, and ensure a perfectly mating joint because the space allows glue squeeze-out. If there is too much glue in the mortise, the space

releases the hydraulic pressure, allowing air or glue to escape. Chamfering can be accomplished by hand with a rasp, but it's better done on the bandsaw, especially if you need lots of tenons for a large job. Set the bandsaw table to 45° and adjust the fence so that it cuts off a small portion of the tenon's square edge. You may want to take the corners off a scrap tenon by hand and trial-fit it into a mortise, to get an idea of how much material has to be trimmed. Once set, chamfer all pairs of opposite edges on each tenon, and then tilt the table 45° the other way and repeat the cuts.

If you've been careful, you should have a close but not-too-tight fit between the mortise and the tenon. If the joint is too loose, the inside contact between the two pieces—so important for strength—is insufficient. If the joint is too tight, you may actually crack the frame members during glue-up or starve the joint of glue and leave it weak.

Gluing up—After all the mortises and tenons are cut, I usually test-fit the frames together. If I'm making face frames, as for kitchen cabinets, I like to reduce the thickness of the mortised members (usually the stiles) so that the tenoned members (the rails) on the front side of the frame are slightly proud (less than $\frac{1}{64}$ in.). This makes it easier to plane the frames around the joints perfectly flush without cutting across the grain.

When I'm ready to glue up, I prepare all the clamps and clamp pads I'll need and clear a flat surface to work on. I apply glue to the tenons with a flux brush (available at a hardware store) with the bristles cut at a 45° angle. I then apply yellow glue into each mortise using a cotton-tip swab. When you clamp the frame, make sure the pressure is even at the joints. When all clamps are in place and tightened, check the flatness of the frame with a straightedge, measure the diagonals for frame squareness and clamp across to pull the frame true if necessary. Clean up squeeze-out with a sharp plane or chisel after the glue has dried for a couple of hours—not overnight. If the glue dries overnight, it becomes brittle and hard on sharp tools. □

Mark Duginske is a Wausau, Wis., author, instructor and woodworker. His latest book, Bandsaw Handbook, was published recently by Sterling Publishing Co., 387 Park Ave. S., New York, NY. 10016.

Fig. 2: Adjustable tenon fence

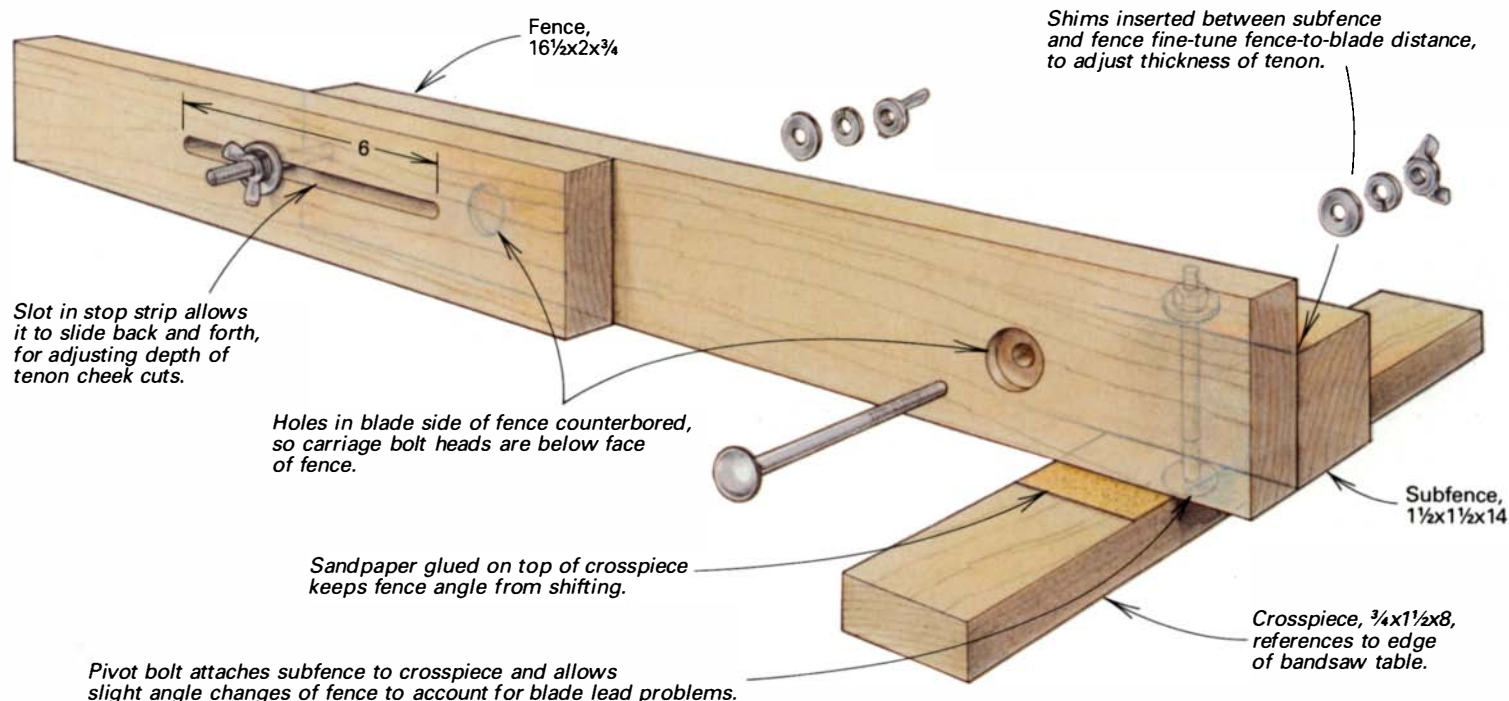

A Shop-Built Shaper

Tilting table adds a new angle to panel-raising

by Frank Perron, Jr.

When I was faced with the task of making a bunch of raised panels for several large jobs, I wanted to avoid the drudgery of sanding out sawblade marks on panels raised on the tablesaw. This tempted me to buy a shaper big enough to handle panel-raising. I remembered a mammoth cast-iron shaper that an old furnituremaker in Vermont had shown me. The huge machine barely vibrated as it ran, even though the raised-panel cutter mounted on it was half a foot in diameter. Further, the machine was used primarily for panel-raising, so it sat in the corner always ready to go. Since I wanted the quality cut of that heavy, high-quality machine, but couldn't afford the luxury, I decided to design and build my own shaper.

Before starting on my shaper, I thought it would be prudent to check out the available selection of stock raised-panel cutters. I discovered that there were relatively few straight-style raised-panel

cutters available right off the shelf. I would need a different cutter for each job and carbide-tipped cutters are more than \$100 each. So I quickly decided to take a different slant on shaper design to get a variety of profiles with a single cutter. This meant I needed a way to change the attitude of the cutter in relation to the table. Some very expensive shapers have tilting spindles for just such a purpose, but this system would have involved devising a mechanism to tilt the entire motor and spindle assembly—a complicated task. My more practical solution was to tilt the shaper table.

My final design is shown in the photo below and figure 1 on the facing page. The shaper has a welded-steel base and employs a store-bought arbor assembly with a 1-in. spindle. The machine operates like a conventional shaper, except for the table: It tilts about 16° down and about 3° up. The machine weighs about 250 lbs., making it heavy enough not to dance all over the floor when I use it. Although the construction of the shaper involves quite a bit of metalworking (see “Metalworking in the Woodshop,” *FWW* #79, p. 84), relatively few metalworking tools are needed to build the shaper, and you could substitute a wood base if you wish. Materials cost me about \$350, including the spindle, but I used a lot of spare materials that were lying around my shop. While my machine was designed specifically for panel-raising, the basic shaper can handle any sort of cabinetmaking or millworking job, so you can customize it to suit your application. Whether or not you choose to duplicate the design in this article or alter it to your taste, I hope my experiences will inspire you to make your own shop-built shaper.

Building the base—Conventional shapers are built with the spindle/motor assembly hanging from the table, which in turn is mounted atop a base. Because I designed my table to tilt, the base became the heart of the machine, with motor and arbor bolted to it. The base, shown in figure 1, is made with welded steel tubing and angle iron, and has sheet metal panels on three of its sides. Foam insulation is glued to the inside surfaces of the panels to reduce noise. The top of the base is stepped, to provide clearance for the tilting table, and the 8-in. steel channel at the top of the welded base provides a mount for the shaper's spindle assembly. The two rear legs sport built-in casters that make the shaper easy for one person to move around.

All of the steel for my base came from a local scrap yard, so any suitable steel tubing or angle stock sizes you have lying around could be substituted for the ones I used. I cut all the pieces for the base frame to length with an abrasive blade in a motorized miter saw, and clamped the parts together. I used an arc welder and worked from the inside of the frame, so that the weld beads would not show, to give the machine a clean look. If you don't weld, you could have a friend or local welding shop make the base for you,



Building your own shaper, using a commercially made spindle assembly, is an economical way to add heavy-duty, panel-raising capacity to your shop. With its tilting table, welded-steel frame and 1-in.-dia. spindle, Perron's shop-built shaper shown here is tough enough to handle large-diameter panel-raising cutters and produce clean, chatter-free cuts.

Fig. 1: Tilting-table shaper

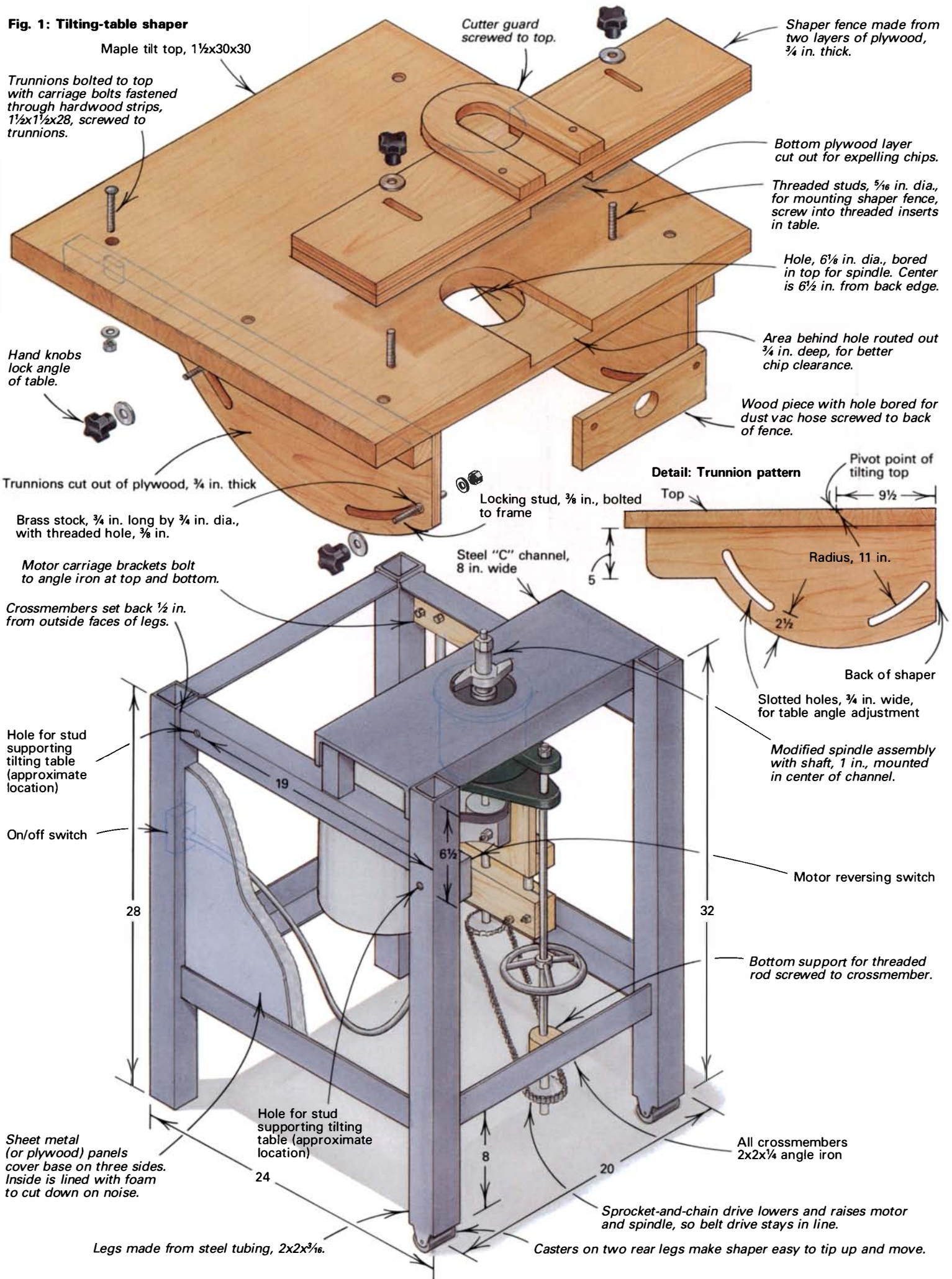



Starting with the stock spindle he purchased, Perron modified the assembly to allow the cutter to be raised and lowered via a handwheel at the back of the shaper. A chain drive at the bottom links the handwheel shaft with a sliding motor carriage and adjusts the height of both the motor and spindle synchronously, to keep their V-belt drive pulleys aligned.

or you could make it out of wood. If you choose the latter alternative, use fairly large-dimension stock and employ strong, tight-fitting joinery, like mortise and tenon, so the base will be heavy and withstand vibration. After the frame was finished, I attached the metal side panels with pop rivets and bolted the casters to the rear legs, notched earlier. For anti-vibration padding and skid resistance, I glued pieces of neoprene, a synthetic rubber material, to the bottoms of both front legs.

Modifying the spindle—After unsuccessfully trying to design a safe and easy-to-build spindle that could adjust up and down and turn safely at 7,000 RPM, I decided to buy a commercially made spindle assembly. The one I selected is heavy and well made, with a 1-in.-dia. shaft (available from Mooradian Manufacturing Co., 1752 E. 23rd St., Los Angeles, Cal. 90058). I chose a 1-in. shaft because it fits the large panel cutters I wanted to use and because I wanted the shaper to stand up to heavy cutting pressures without deflecting. Although the stock spindle comes with a simple height adjustment screw, I wanted to be able to raise and lower the cutter without throwing off the alignment of the spindle and motor drive pulleys. Hence, I designed the height adjustment system, shown in figure 2 on the facing page, that consists of a modified spindle with a threaded rod running down to a sprocket and chain that in turn connects with a threaded rod that runs through a sliding motor carriage. When the handwheel on the spindle rod is turned, not only does the spindle (and hence cutter) height change, but the chain drive raises or lowers the motor as well, keeping the V-belt pulleys in line (see the photo above).

Modifying the stock spindle first requires drilling out the threads in the spindle housing flange. The lower flange on the moving part of the spindle is then fitted with a 1/2-13 Helicoil insert—a job I had done at a machine shop. Although you can thread the cast-iron flange, the Helicoil provides strong steel threads for the raising and lowering mechanism. One end of a 1/2-13, 24-in.-long threaded rod is locked to the upper flange with nuts that are drilled through so they can be secured to the rod with cotter pins. Next, the spindle assembly is bolted to the underside of the channel atop the base, with a 1/2-in. neoprene washer between them to act as a gasket. I scrounged a handwheel from an old lathe to use as the adjustment wheel, and I locked this on the threaded rod with a pin. A stop nut, to limit the travel of the spindle to about 3 in., is positioned and cotter-pinned to the rod, as shown in figure 2. The bottom end of the threaded rod is held by a homemade pillow block—a block of wood drilled to fit the rod and screwed to the angle iron crossmember at the back of the base.

At this stage, I tested the modified spindle and it worked well, except that the fit between the inner spindle sleeve and the outer housing was so tight that sliding them was difficult. To remedy this, I took the assembly apart, cleaned the surfaces and coated them with Molykote 321-R, a dry lubricant designed for use with tightly mating parts (made by Dow Corning and available from your local bearing supply store). After reassembly, the spindle adjusted much more easily. I fitted my shaper with a special spindle lock (you can see the knob beneath the table in the photo on p. 50), but the stock spindle lock is also easy to use.

Making the sliding motor carriage—The motor carriage acts as a mount for the shaper's motor and allows the motor to travel up and down in unison with the spindle. The carriage is made from four hardwood scraps, a square of 3/4-in. plywood, two 20-in. lengths of 1/2-in. galvanized pipe (that act as guide rails) and a 22-in.-long, 1/2-in. threaded rod raising screw. For the carriage to slide smoothly, the holes for the pipe and rod need to be drilled accurately. Therefore, it's best to line up and clamp together the four hardwood pieces (dimensioned as shown in figure 2) and then drill them all at once. I ground down a 7/8-in. spade bit until it was a bit larger than the OD of 1/2-in. pipe. Also, drill a slightly oversize hole for the 1/2-in. threaded rod. Two of the hardwood pieces become the pipe holders and receive bandsawn kerfs and holes for 1/4-in. carriage bolts in both ends. The other two pieces are glued and screwed to the plywood square, which has holes for mounting the motor. A piece of 1/4-in.-thick brass plate, tapped to fit the threaded rod, is screwed to the motor platform as shown. After the pipes are slipped through the holes in the platform, which may require reaming so the platform slides smoothly over the pipe, they are fitted in their holders and the carriage bolts are tightened to lock the pipes in place. The threaded rod is then screwed into its plate and nuts and washers are fitted at each end. The nut at the top is recessed in a counterbored hole, and both nuts are pinned through the rod, to keep them from moving.

Once the carriage is completed, the motor is bolted on its platform and the entire assembly is bolted inside the base. My motor is a 1-HP, 3,450-RPM capacitor-start motor. While this has proved adequate in most conditions, you may opt for something a little more powerful, say a 2-HP motor. I mounted a metal on/off switch box to the front of the base, and also a reversing switch, fixed on the back of the machine to eliminate someone accidentally mixing it up with the on/off switch. A reversing switch is often necessary on a shaper, so that cutting direction can be changed. A V-belt connects the motor and spindle pulleys. The pulley ratio is a little more than 2-to-1, which yields a spindle speed of about 7,000 RPM. I

Fig. 2: Motor carriage and modified spindle

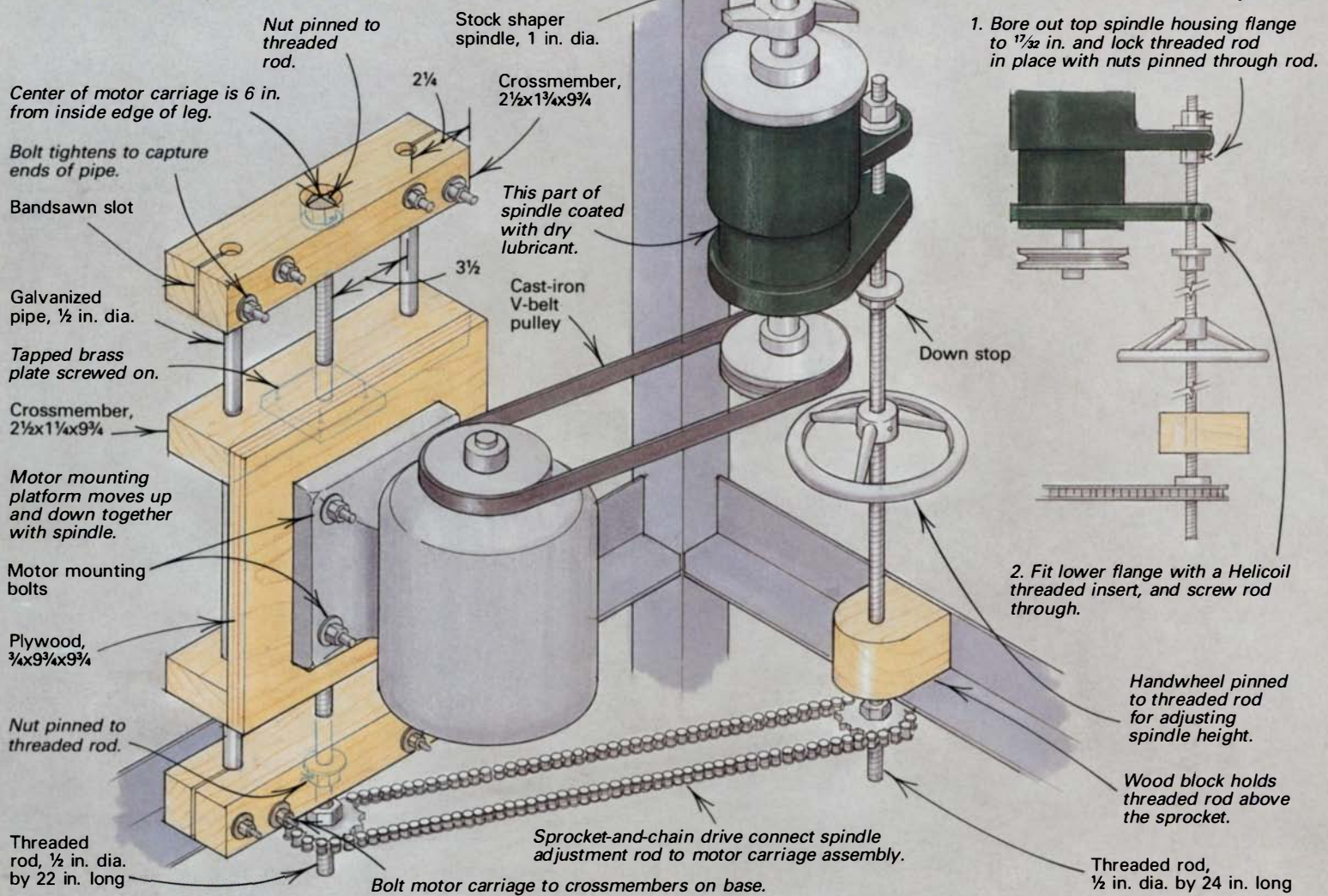

chose Browning cast-iron pulleys fitted with split-taper bushings that grab the shaft they're mounted on like a collet. At \$30 apiece, these pulleys aren't cheap, but they're precise and won't come loose during high-speed operation. The bottom ends of the threaded rods on both the motor carriage and spindle are fitted with 2-in.-dia. sprockets, screwed on and pinned in place, and tied together with no. 35 roller chain. Sprockets, chain and pulleys are available from your local motor and bearing supply house.

The tilting table—Before I could build the tilting mechanism for my shaper, I had to determine the best pivot point: an axis for the top to turn around. Because I had decided to mainly use my shaper with 5¾-in.-dia. raised-panel cutters, I set the pivot point at the intersection of the tabletop and the outer shoulder of the cutter (see the detail in figure 1 on p. 51). Pivoting at this point allows me to set the height of the shoulder of the cut to stay the same depth, regardless of the angle of the table. Tilting allows me to get the desired thickness I want on the outer edge of a panel, regardless of the thickness of the stock I'm using.

The pivot mechanism I designed is a trunnion-type system, similar to the mechanism used on many bandsaws and sanders to tilt their tables. Two plywood trunnions attach to the underside of the table, each with a pair of curved slots that ride on studs, which are 4-in. lengths of ¾-in. threaded rod, bolted to the base. A hand knob on each stud clamps the trunnion tightly against the base, locking the table in place. A bushing that rides in the trunnion slot is made from a ¾-in.-long, ¾-in.-dia. piece of brass stock, center-

bored and tapped to screw on the stud.

Trunnions are bandsawn from a good grade of birch plywood, with no voids in the core layers, following the pattern shown in figure 1 on p. 51. The curved slots are cut with a ¾-in. straight bit in a router mounted on a swing-arm jig. The radius of these is 11 in. to the center of the slot, as measured from the desired pivot point of the table. To make the slots, the swing arm's pivot point is set in a small scrap of plywood, temporarily tacked to the top edge of the trunnion.

The shaper's 1½x30x30 tabletop is glued up from strips of ¾ maple. Since my thickness planer only handles 12-in.-wide stock, I glued up the top in three 10-in.-wide sections. After planing each section flat, I glued the three panels together. To me, unfinished maple is smooth enough for the table, but you can make the top out of plywood or particleboard and cover it with plastic laminate, for a slicker, more wear-resistant surface. Then, a fly-cutter chucked in the drill press was used to cut out the 6⅞-in.-dia. hole for the cutter. Later, I decided to rout a ¾-in.-deep recess at the back of the cutter opening to increase the shaper's chip clearance.

The top is fastened to the plywood trunnions with carriage bolts through two 1½x1¾x28 hardwood strips screwed to the trunnions. These strips stiffen the top and provide a strong joint between it and the trunnions. Two slotted bolt holes at the ends of each strip allow for expansion and contraction of the solid-wood top.

Once the trunnion sections are attached to the top, the whole assembly is ready to be mounted on the base. First, the surface of the table is positioned square to the spindle in all directions. I use



By tilting the shaper table relative to the cutter, Perron gets a variety of raised-panel profiles from a single cutter—a real bonus since carbide cutters are expensive. The U-shape guard on the adjustable fence protects Perron's hands as he feeds a cherry panel by the cutter.

Fig. 3: Possible panel edge flair problem

Edge of panel flairs out, not straight or tapered like regular raised panel. Trim for straightness.

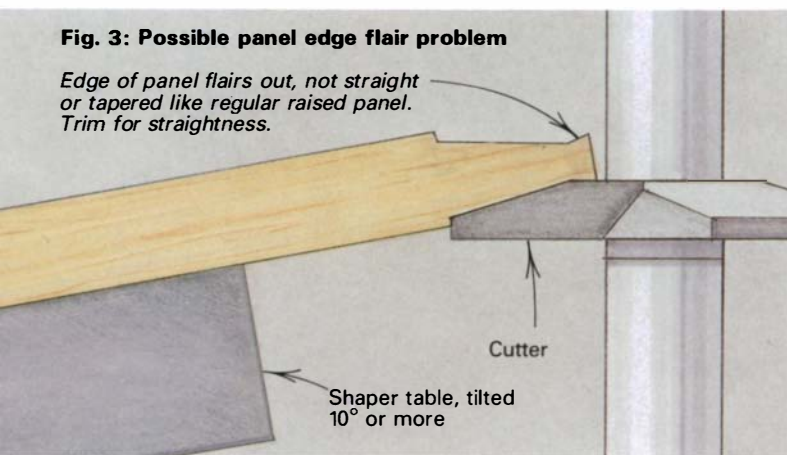

wedges and shims made from scraps to align the table, and then use a pair of pipe clamps attached across the trunnions to temporarily lock the table in place. Next, the position of the locking studs is marked on the base, using the slots as a guide. With a metal punch, I mark the center position of each stud, one on the top crossmember and one on the rear leg, for each trunnion. After removing the table and drilling the $\frac{3}{8}$ -in. holes, the studs are installed with nuts and lock washers. The brass bushings must be shimmed out slightly on the crossmember studs to make them flush with the rear leg studs. Large washers fit under the clamping knobs, to distribute the clamping pressure on the plywood trunnions. I purchased easy-to-grip locking knobs from Reid Tool Supply Co., 2265 Black Creek Road, Muskegon, Mich. 49444.

The fence—Even on a commercially made shaper, I'll sometimes set the stock fence aside and make a custom one for a specific job or cutter setup. By doing this, I can make the operation safer and improve chip clearance. I made my shaper fence from laminated plywood topped with a guard that overhangs the cutter to keep hands out of harm's way. With the protection this fence affords, I feel safe raising panels as narrow as 10 in. wide, holding them free-hand. The fence is notched, to clear the top of the spindle, and the lower part is

cut away completely behind the cutter, for chip exhaust. The outside profile of the U-shape guard is bandsawn slightly larger in diameter than the cutter and attached to the top of the fence with two drywall screws. Two 3-in.-long, $\frac{3}{8}$ -in. studs that fit through slotted holes cut in the fence attach the fence to the tabletop. The studs are screwed into threaded inserts installed in the tabletop. To take care of the prolific amount of dust and chips that panel-raising produces, I bored a hole in a wood scrap to fit the hose on my dust-vac and screwed this to the back of the fence (see the photo on p. 52).

My panel raiser is a joy to use, it's smooth running and I like listening to it hum. It is satisfying to run a piece of stock by the cutter and flip it over to find a panel bevel that needs no sanding. The only problem I have had is with panels cut using the full width of the panel cutter with the table tilted to 10° or more (see figure 3 at left). The panel edges flair slightly, preventing proper seating in a frame groove or rabbet. However, the problem can be eliminated by not using the full width of the cutter when raising, or by trimming the flared edge with a straight cutter in the shaper or with a handplane. □

Frank Perron is a Field Experiment Coordinator for the U.S. Army Corps of Engineers and part-time woodworker living in Pomfret, Vt.

Safety warning

The shaper has the potential to be a dangerous machine. The rotational force of a large panel-raising cutter can grab even a large panel out of your hands and hurl it with surprising force. Worse, the force can unexpectedly pull your hand into the cutter, with disastrous results. Therefore, *always use the shaper with the guard in place and keep your hands well clear of the cutter*, wear safety glasses or a face shield and avoid wearing jewelry or loose clothing. As with any home-built machine, make sure all parts are properly installed, tightened and adjusted before use. Also when raising panels, always take several shallow passes rather than one deep cut.

Sharpening Chisels and Plane Blades

Producing razor-sharp edges with honing guides and waterstones

by Bill Stankus



Plane blades and chisels must be honed to a narrow range of cutting angles, and this precision can be difficult to attain when free-handing the blade on a sharpening stone. Honing guides, such as

the Eclipse and Veritas, minimize the chance of error by holding the tool at a precise bevel angle. These guides roll on the stone itself, so you needn't reset the angle when going from one grit to another.

Improper tool sharpening has probably done more to ruin tools, wood and enthusiasm than any other aspect of woodworking, yet there's no excuse for dull edges, with the sharpening equipment now available. I've developed a method that lets me flatten and polish the back of a chisel or plane blade, and then hone the blade's dull cutting edge to unbelievable sharpness in a matter of minutes. The secret? Using a honing guide, such as those in the photo above, a series of waterstones, and a strop or buffing wheel. Honing guides hold the chisel or plane iron at a specific, precise angle so the user can concentrate on removing metal; man-made Japanese waterstones have predictable grits, from very coarse to very fine; and final-polishing with green rouge on a leather strop or hard-felt wheel perfects the edge. Waterstones and buffing compounds are widely available through most woodworking and some industrial supply houses.

For the part-time woodworker, who wants an inexpensive system, I suggest an Eclipse honing guide (see source of supply note at end of article), 120-, 800- and 1,200-grit waterstones, and a leather strop. Over time I've added the finer 4,000- and 8,000-grit stones, nagura stones (which create a muddy slurry as they clean and remove the sharpening stone's bonding agent and expose fresh grit), a powered, hard-felt buffing wheel and green rouge, along with a second honing guide, the Veritas (see supply note), and various bevel gauges.

Here I'll concentrate on sharpening chisels and plane blades used by furnituremakers and cabinetmakers. For best performance, these tools must be shaped and honed to a consistent, narrow range of cutting angles, depending on the type of tool, the wood to be cut (hardwoods usually require steeper bevels than softwoods) and the type of cut. I grind a 15° to 25° bevel on light paring chisels driven by hand, without a mallet; for standard bench chisels and plane blades, bevels from 20° to 30° work best. My mortise chisels have bevels

from 25° to 40°, depending on the type of wood I'm working. But for general-purpose chisels, a 25° bevel is a good compromise.

Bevels and honing guides—Many woodworkers have difficulty producing good cutting edges by hand-holding a tool on a stone. The human hand is just not steady and accurate enough to hold the tool at a specific angle while moving it back and forth on the stone. Honing guides eliminate the problem because they can be set to an exact angle to provide a steady platform to carry the blade across the sharpening stone.

Although many tool stores and mail order houses offer various honing guides, I prefer the Eclipse and Veritas models because they're adjusted easily to a specific angle and are designed to roll on the stone itself, rather than the bench. Guides with rollers that run on the workbench must be readjusted for each stone, whereas guides that roll on the stone guarantee the same angle from stone to stone, and thus produce more consistent results. The Eclipse honing guide grips the tool's side edges, which is fine for bevel-edged chisels and plane blades, but it won't grip all thick mortise chisels or narrow, 1/8-in.-wide chisels. The Veritas honing guide is good for most tools, including skewed blades or thick chisels, such as mortise or Japanese chisels. In addition, it has a spring-loaded, cam-type roller for fast, fine adjustment in small increments.

On the Eclipse, the bevel angle is determined by the distance the cutting edge projects beyond the guide. Instructions for honing 25° and 30° bevels are marked on its side. The Veritas guide is set with an optional angle jig, which measures bevels directly. On either guide, an engineer's metal protractor can also be used to set bevel angles: Hold one leg of the protractor against both the tool's bevel and the guide's roller and the other leg along the top of the

tool and read the angle on the protractor.

With proper technique, you won't groove the soft waterstones with the guide's roller, but since most sharpening operations normally wear away the stone's surface, you'll periodically have to dress the stone. Since it's easiest to gouge the stone during a push stroke, apply pressure and cut on the pull stroke. Place both thumbs under the blade, behind the guide and near the roller, and both index fingers on the tool's surface near the cutting edge. Apply even, downward pressure with your index fingers as your thumbs steady the guide as it's pulled on the stone (see the photo below). For the return stroke, lessen the downward pressure of the index fingers and gently push the tool back with the thumbs; then repeat the cutting, pull stroke with little or no pressure applied on the guide's roller. Check the straightness and squareness of the blade's cutting edge with a small square.

Making secondary bevels—I make a secondary or micro bevel on my tools because it provides a stronger edge and speeds the honing process, since only a narrow area of the edge must be polished. Secondary bevels are set by adjusting how far the cutting edge projects beyond the honing guide. Begin with a secondary bevel that's 5° greater than the primary bevel, but experiment with different angles for different woods and various cuts. As on the primary bevel, a steeper angle is better on hardwoods and end-grain cuts, and a shallow angle is better on softwoods and paring cuts. I reshape the main bevel when the secondary bevel is about one-third up its surface.

Straightening the tool's back—The back of a chisel or plane blade must be prepared as carefully as the bevel. The backs are generally buffed at the factory and this process may round the cutting edge or leave enough grinding scratches to make the cutting edge look like a serrated knife, as shown in the top photo at right. Such a rough edge won't stay sharp for as long a time as an edge that has been honed and polished on both sides, like the one shown in the bottom photo at right.

Test the back of a new chisel or plane blade for flatness by laying the back on an 800-grit stone and moving it back and forth a few times. If some areas remain untouched while scratches from the stone are on others, the back must be flattened, beginning with a 120-grit stone. When scratches evenly cover the entire back of



The tool's edge is ground mainly on the pull stroke. The author's hands surround the chisel and honing guide as he pulls and presses with his index fingers while honing on a wet 1,200-grit stone. On the return stroke, he uses his thumbs to push against the guide and doesn't apply downward finger pressure. The small cube is a nagura stone used to prepare surfaces on fine waterstones.

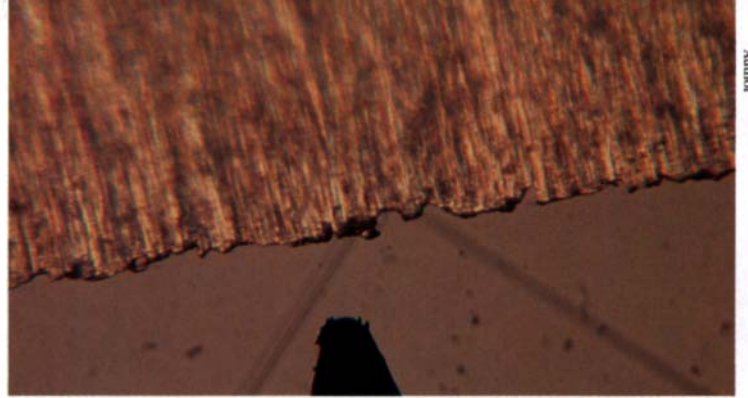

An 80-power microphotograph clearly shows how rough a chisel's cutting edge can be before it's properly sharpened. Stankus sharpened the bevel edge on an 800-grit stone to reveal the ragged edge created by the tool's rough, unpolished back. A pin points to rust visible from the tool's back. The pin looks as dull as a baseball bat.

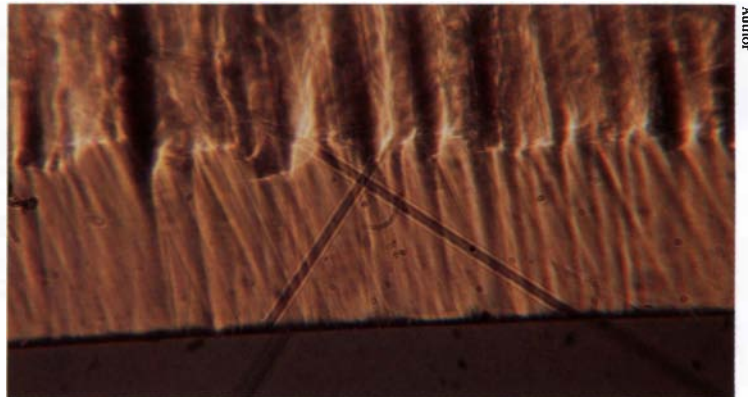

The edge of a properly flattened, sharpened and honed tool is smooth and true, under 80-power magnification. To create this cutting edge, the author honed the back to 8,000-grit, and sharpened the primary bevel to 800-grit and the 1/64-in.-wide secondary bevel to 8,000-grit before stropping it on a buffing wheel with green rouge.

the tool, as on the chisel on the far right in the left photo on the facing page, the back is flat and straight. Now, move on to the 800-grit stone and work up to finer-grit, polishing stones.

Why use waterstones?—I find that flat man-made waterstones are more user friendly than oil stones because they offer such a wide variety of consistent grits, between 800 and 8,000. By comparison, the grit in a natural, hard, black Arkansas honing stone is twice the size of the grit in a 4,000-grit waterstone, which is made of compressed rare earths, ceramics or finely ground natural rock.

All waterstones are "soft," so they continually expose fresh grit as they're worn down. The stones are reasonably priced and most of them are 2¼ in. wide, so they can easily accommodate most plane blades. Usually, 800-grit through 1,200-grit stones cost about \$15 each, and an 8,000-grit stone is about \$50. Finally, using water as a stone lubricant is cleaner and safer than oils and solvents.

I used to keep waterstones soaking in a bucket, but now let the stones dry between jobs and only soak them for 5 to 10 minutes before use. This is a good policy since natural sharpening stones and nagura stones may decompose if they soak for protracted periods of time. I soak the fine-grit stones in a separate bucket, so coarse-grit particles can't contaminate them. Each of the various-grit stones react to water differently. For instance, the 120-grit is forever thirsty, while the 8,000-grit resists wetting. Keep the surfaces wet, not flooded, and don't wipe off the slurry while working. The slurry, which is worn grit and steel particles, acts as a lubricant and grinding compound on coarse-grit stones and a polishing compound on fine-grit stones. A good transitional step, when you're nearly finished with one grit, is to stop adding water until the slurry is dry, while easing up on the downward pressure.



Dressing the tool's back is as important as honing its bevel side. Stroke the entire back on an 800-grit stone; if some areas are untouched while others are scratched from the stone, as shown on the corner of the chisel on the left and the middle of the chisel in the center, the back must be resurfaced. When the stone leaves scratches evenly over the entire back, as on the chisel on the right, the back is flat and straight.



The secondary bevels on these two chisels were polished with a few strokes on a fine-grit waterstone. The dull-looking bevel on the lower chisel should be reground until it looks like the chisel on the top.



Stankus removes the wire edge by lightly touching only the secondary bevel on a spinning hard-felt wheel charged with green rouge. He keeps the tool's edge parallel to the direction the wheel turns.

Step by step, stone by stone—For efficiency when honing a blade, don't skip a grit when working from a coarse-grit to fine-grit stone: 120-, 800-, 1,200-, 4,000- to 8,000-grit. After a few strokes on the first stone, be sure the edge is square, nicks are removed and a continuous wire edge is left. The wire edge occurs when the metal at the tip gets so thin it can no longer support itself and bends up and away from the stone. Each finer-grit stone produces a finer wire edge. Don't remove the wire edge until you've finished with the last stone or the strop, because the wire may tear back into the edge and destroy its sharpness. You're done with one grit when you've entirely removed the scratches left from the previous stone.

The 120-grit stone is for quick removal of steel, such as when resurfacing the back of a chisel or shaping and repairing a bevel. Next use the 800-grit stone, which may be a good first stone for removing minor nicks or to flatten backs that become uneven. Then follow this with the 1,200-grit stone. If the blade is just dull and undamaged, you can renew the edge by taking 5 to 10 passes on a 1,200-grit stone before going on to the finer-grit stones.

For general-purpose tool usage, it's possible to stop with the 1,200-grit stone. However, the delight in seeing highly polished secondary bevels, such as on the chisels in the top, right photo above, and their longer life and greater performance will make it impossible for you to be happy with what I consider to be partly finished tools.

Only the secondary bevel and back needs to be honed with the 4,000- and 8,000-grit stones. These fine-grit stones, which must be prepared with the small nagura stone, have similar characteristics, but the 8,000-grit stone refines the edge to a finer degree. Alternately hone the blade's secondary bevel and back with only a few strokes on the 4,000-grit stone and then on the 8,000-grit stone.

Removing the wire edge—Not polishing out the scratches and leaving a wire edge reduces the tool's ability to hold an edge. The fine wire edge left by the 8,000-grit stone, though it can sometimes be felt with a sensitive finger, is visible only with a hand lens. If not removed, the wire edge can "tear" back into the bevel and accelerate dullness.

Remove this micro wire edge by lightly touching the secondary bevel to a turning, hard-felt wheel that has green rouge on its surface. Pass the edge of the secondary bevel lightly once or twice on the wheel while keeping the tool's edge parallel to the direction the wheel is turning, as shown in the bottom, right photo above. A bench grinder that turns less than 1,800 RPM is best. For odd-shape blades or in the absence of a felt wheel on a grinder, pull the edge of the tool on leather impregnated with the rouge. A word of caution: These stones are somewhat softer than coarse-grit waterstones and they're gouged easily. Stroke them carefully!

If you should gouge a stone or if the stone becomes worn, you can easily resurface it. Although I've used a concrete floor, I now use a sanding screen to flatten uneven stones. Lay the screen on a flat surface and rub a dry stone against the screen until the stone's surface is flat. As when flattening the back of a chisel, observe the scratches the screen leaves on the stone; when they're spread evenly over the entire surface, the stone is flat.

Finally, forget about shaving your arm or nicking your fingernails to test an edge. Just go right to work. □

Bill Stankus is a furnituremaker living in DeWitt, N.Y. For the Veritas and Eclipse guides, write to the companies for the distributor nearest you: Veritas Tools, 12 E. River St., Ogdensburg, N.Y. 13669; James Niell Tools, Ltd., Napier Street, Sbeffield, S11 8HB, England.

Making a Message Center

Apprentice project develops woodworking skills

by Luca Valentino

At first glance, the message center in the photo below looks like a very simple project. And in some ways it is. But there's more to it than meets the eye. Developed as a project for cabinetmaking apprentices at the Labor Technical College in Manhattan, N.Y., the message center involves a wide range of woodworking operations. As such, it's a neat project for those who want to hone their skills while producing a functional item. There are many ways to build the piece, but here I'll present only the apprentices' method, so you can work along with them and see how students learn to build accurately from detailed plans.

Projects like the message center are part of a four-year program for cabinetmakers. The apprentices attend four hours of classes one eve-

ning each week, while working full time in union shops that sponsor their school training. By the end of their fourth year, each apprentice should have mastered the major aspects of the trade, including drafting, reading blueprints and using both hand and power tools, and will have worked on some fairly complex projects, such as a flight of stairs and a French provincial commode.

The construction plans for the message center, which I drew as an apprentice, are shown in figure 1 on the facing page. Basically it's a wall-hung shelf unit with a cork-veneered, backing board for tacking notes and a small drawer between the two lower shelves. All three shelves are tongued into stopped dadoes in the case sides. Sounds simple enough, doesn't it? But notice that even the radii of the curves on the case sides and crest rail are specified. The challenge for the students is to build the piece *exactly* as specified on the plan, and this requires the use of patterns and templates.

Making the patterns/templates—To ensure that the curved case sides and the crest rail will precisely match the specs on the plan, it's necessary to make full-scale patterns for these parts from $\frac{1}{4}$ -in. tempered Masonite. The patterns serve a dual purpose. First, they're traced around for laying out the parts on the wood and then later they're used as template guides for final trimming the curves with a bearing-guided flush-trim router bit. With these templates, it's a snap to consistently reproduce the curves, whether you're making 2 parts or 200 parts. To aid in making the patterns so they match the specs exactly, draw a 1-in. grid on the Masonite. Swing the required arcs with a compass from the centers shown in figure 2 on p. 60 and connect these arcs with tangent lines. Mark the locations of the shelf dadoes and the template attaching screw holes. You should also mark on the case-side pattern for the locations of the shelf dadoes that will be routed on the inside of each side. Then, cut the patterns out with a bandsaw and smooth them carefully to the line with sanding blocks and files. Take care to keep the edges square and make the curves smooth and precise because any inconsistencies will be transferred to the wood parts. With patterns in hand you're ready to begin constructing the piece.

Building the message center—The stock bill, located in the lower right corner of figure 1, gives you all the information you need to cut out the shelves, backs and drawer parts. Rip the piece for the crest rail 2 in. wider than its finished width of $2\frac{3}{4}$ in. so you'll have some extra stock to attach the crest rail pattern when trimming it with the router (see figure 2).

The dimensions of the stock that's glued up for the case sides are given in figure 2. Center the glue line exactly $7\frac{3}{16}$ in. from each edge so it will intersect the point where the two arcs meet just above the drawer space on the case sides. Placing the glue line at this



This mahogany message center is a second-year project at the Carpenters' Apprenticeship School in New York City. It's designed to teach techniques, tool use and how to work to a plan.

Fig. 1: Plan and stock bill

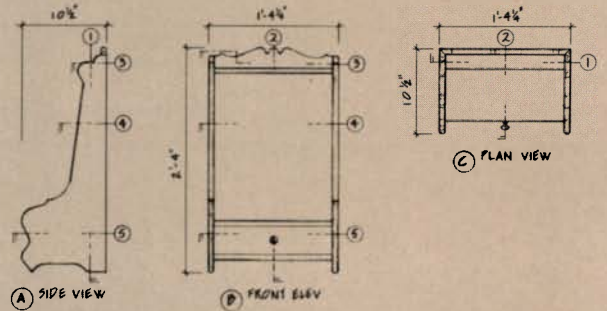
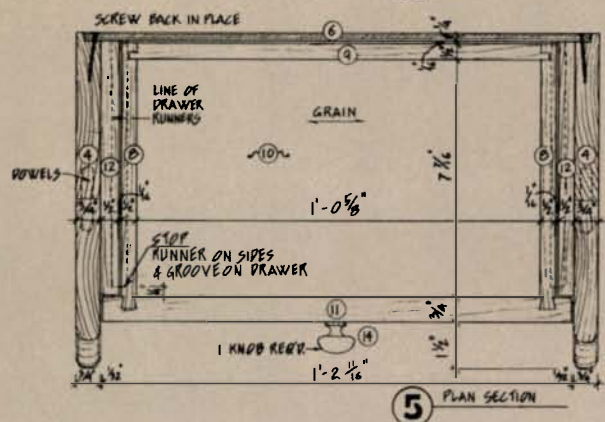
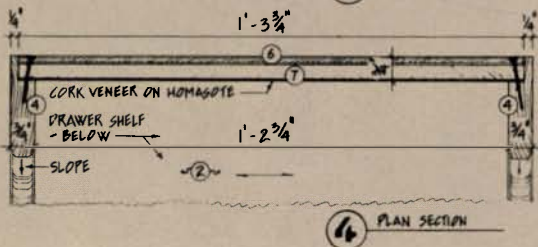
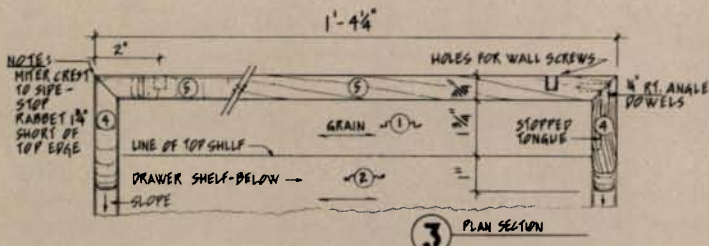
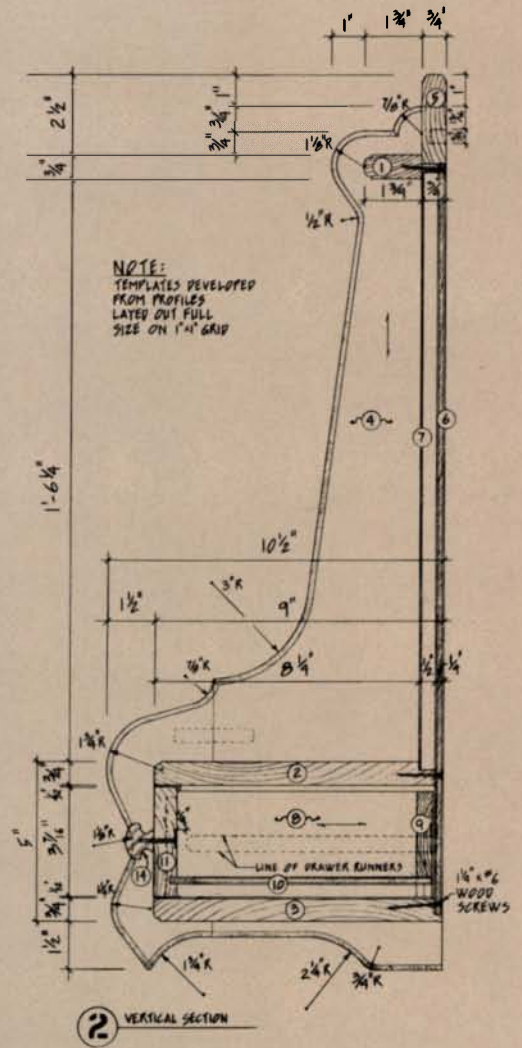
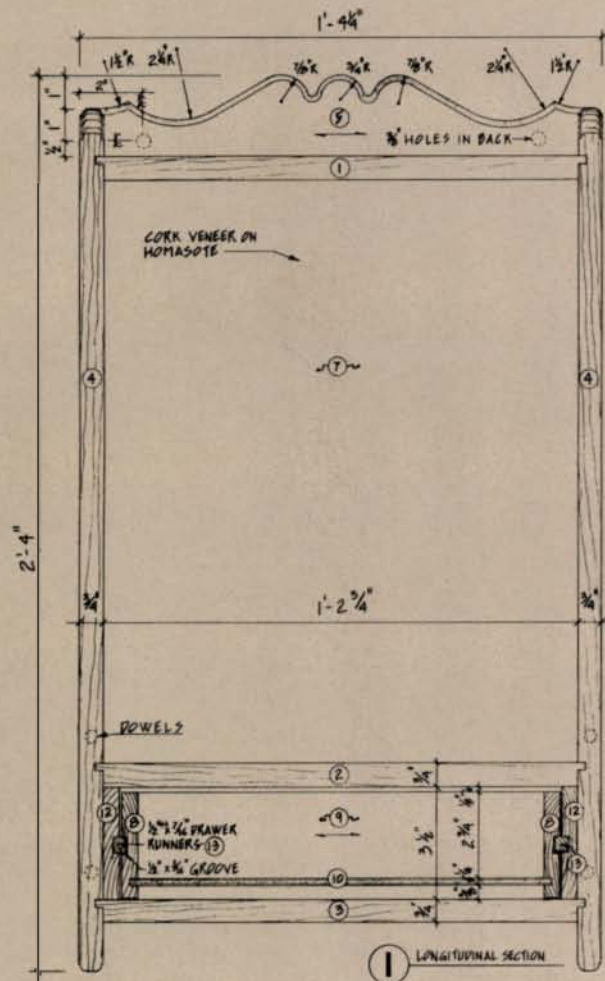

STOCK BILL

#	✓	QTY	DESCRIPTION	TH	WIDTH	LENGTH	REMARKS
1		1	TOP SHELF	3/4"	2 1/4"	1'-5 3/4"	SOL. MAHOG.
2		1	DRAWER SHELF	3/4"	8 3/4"	1'-5 3/4"	-11-
3		1	BOTTOM	3/4"	9"	1'-9 1/4"	-11-
4		2	SIDES	3/4"	10 1/2"	2'-5"	-11-
5		1	CREST	3/4"	2 1/4"	1'-4 1/4"	-11-
6		1	BACK	1/4"	1'-3 3/4"	1'-11 1/2"	FIR PLY
7		1	MESSAGE BOARD	1/2"	1'-3 3/4"	1'-6 3/4"	CORK V. ON HOM.
8		2	DRAWER SIDES	1/2"	3 3/8"	8 3/8"	SOL. BIRCH
9		1	DRAWER BACK	1/2"	2 3/4"	1'-10"	-11-
10		1	DR. BOTTOM	1/4"	8 3/8"	1'-11"	BIRCH PLY
11		1	DR. FRONT	3/4"	9 3/8"	1'-2 3/8"	SOL. MAHOG.
12		2	DR. GUIDES	1/2"	3 1/2"	7 1/8"	SOL. BIRCH
13		2	DR. RUNNERS	3/8"	1/2"	7 3/4"	-11-
14		1	DR. KNOB				SOL. BRASS

LUCA VALENTINO
N. Y. C. R. C. L. T. C.
MESSAGE CENTER

Fig. 2: Layout for case sides and crest rail

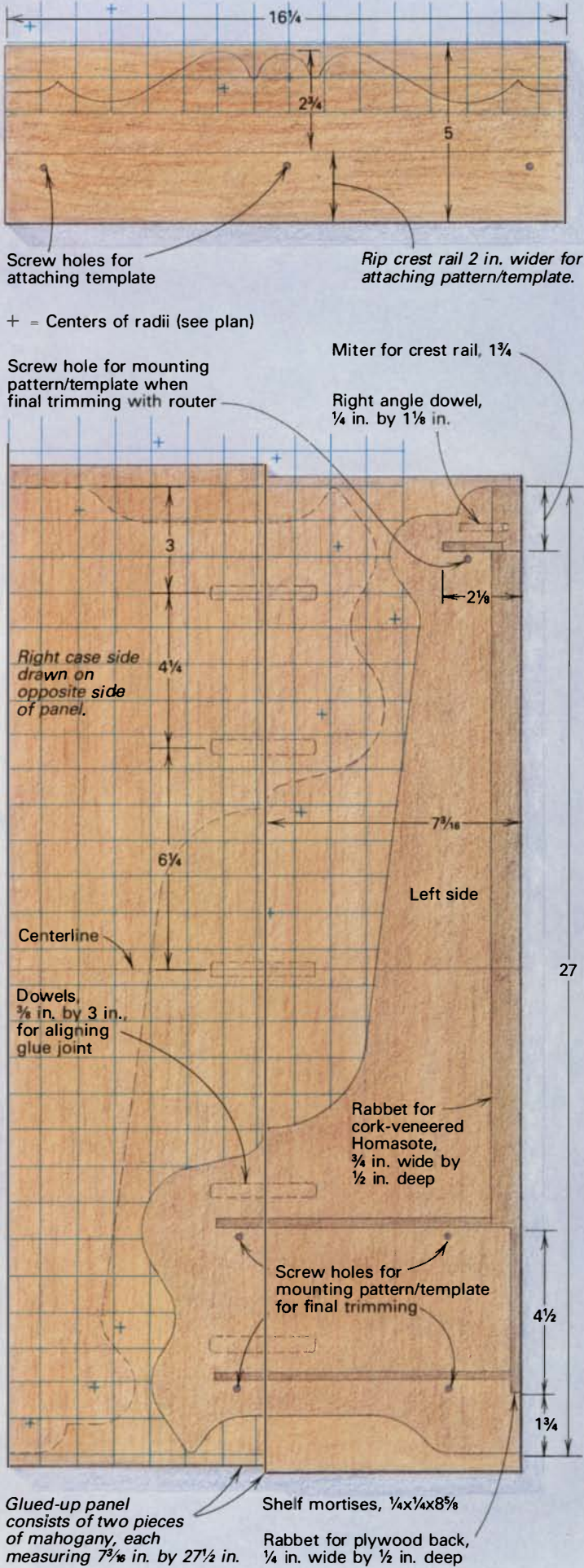

Above: Valentino routs the rabbet for the back with a guide block clamped to the router base. The narrow portion of the back rabbet is for the $\frac{1}{4}$ -in. plywood back that extends top to bottom; the wider portion accommodates the cork-veneered bulletin board. Below: The author cuts the stopped miter on the top of the left case side, stopping the cut when the pencil line on the workpiece aligns with the line on the saw's throat plate. The miter on the right case side was cut using the same setup, but with the side lying flat on the saw table instead of on edge. The holes in the miters, for the right-angle dowels, are drilled before mitering.



point will make the joint virtually invisible on the front edge of the sides. To register the pattern, draw a horizontal centerline on both the pattern and the glued-up stock and align them while holding the pattern's back edge along one edge of the stock. Trace around the pattern once on each side of the stock as shown in figure 2. Don't forget to mark on the stock for the locations of the shelf dados.

Rout the shelf dados first with a 1/4-in. straight bit and a guide fence clamped to the stock. Then, rout the 1/2-in.-deep back rabbet with a 3/4-in.-wide straight bit and a 3/4-in.-thick guide block clamped to the router base. The top photo on the facing page shows how the back rabbet steps in from 1/4 in. wide, for the plywood back, to 3/4 in. wide to accommodate the 1/2-in.-thick backing board that's framed between the bottom and top shelves and the sides. Rout the 1/4-in.-wide rabbet from bottom shelf to top shelf. Leaving the bit set to 1/2 in. deep, reset the guide block to rout the wider portion of the rabbet. Flip the panel over and cut the dados and rabbets on the opposite case side. Square up the rounded ends of the rabbets with a chisel.

After the dados and the rabbets are cut, bandsaw out the case sides and the crest rail, leaving them about 1/16-in. oversize so you can final trim them with a 1/4-in.-dia. flush-trim, ball-bearing-piloted router bit guided by the template. Carefully realign the patterns/templates on the stock and screw them in place. Screw the side template to the inside surface of the case sides, locating the screws 1/4 in. below the dados so that when the case is assembled the shelves will cover the holes. Now, trim the curves with the flush-trim bit, using a climb or reverse cut to prevent end-grain chip-out. The tight corners that the bit can't reach are cleaned up with a sharp chisel and a mill file after the templates are removed. To rout the decorative profiles on the edges of the sides and crest rail, I use a high-speed steel, 1/4-in. roundover bit, the kind with a guide pin as opposed to a bearing (available from Tools on Sale, 216 W. 7th St., St. Paul, Minn. 55102-2599). The guide pin's small diameter fits into the 1/4-in.-radius curves in the crest rail, so the profile can be cut without having to work the tight corners with chisels.

In order for the molded profiles of the sides and crest to blend smoothly into one another they must be mitered. To align and strengthen these miter joints, I reinforce each of them with a 1/4-in., plastic right-angle dowel, available from Dave Sanders and Co., Inc., 111 Bowery, New York, N.Y. 10002. It may seem troublesome to drill the mating holes in a miter, but it's quite easily done by drilling the holes with a doweling jig before cutting the miters (see the bottom photo on the facing page).

Cutting the stopped 45° miters on the top of the case sides with the tablesaw is a little tricky. One of the case sides is run laying flat on the saw table and the opposite case side is run on its edge. The bottom photo on the facing page shows my tablesaw setup. I screw an auxiliary fence to the saw's rip fence, tilt the blade 45° and raise it until it cuts into the auxiliary fence. I make a test cut on a 3/4-in.-thick scrap to be sure the miter intersects the top corner of the test piece. Pencil marks on the fence and throat plate note the beginning point of the cut. I also square a line on the outside face of each case side 1 1/4 in. down from the top edge and I stop the cut when the line on the side reaches the line on the fence or throat plate. When cutting the miters, the small cutoff may be kicked back, so for safety, turn the saw off before backing either of the pieces off the blade.

The ends of the crest rail are mitered using the miter gauge and the same tablesaw setup. Hold the crest rail's straight edge against the miter gauge face and miter one end; then reverse the miter gauge in the same slot, so that it's in front of the workpiece, and miter the other end. To keep the triangular offcut from kicking back, I push the miter gauge with my left hand and push the offcut clear past the blade with a 2x2x12 backup block in my right hand.

When the curved parts are complete, you can cut the tongues on

the ends of the shelves, rabbet their backs for the backing board where necessary (see figure 1) and rout the decorative bead on their front edges. After dry fitting the shelves to the sides, carefully spread glue in the dados and on the tongues and clamp the case together using edge-jointed 2x4s at each shelf to distribute the pressure. Check the case for squareness, and then test-fit and glue the mitered crest rail in place with the right-angle dowels.

Making and fitting the drawer—Drawer construction details are given in figure 1 on p. 59. The sliding dovetails that join the sides to the front are cut with a table-mounted router. First cut the dovetail-shape dados on the inside of the drawer front, and then cut the dovetail tenons on the ends of the drawer sides so they fit into the mortises. For more on routing sliding dovetails, see *FWW* #80, p. 91.

Before gluing up the drawer, rout the stopped grooves for the runners in both the drawer sides and the guide blocks. The guide blocks provide side guides for the drawer by spanning the 1/2 in. that the sides are setback from the ends of the drawer front. Use a 1/2-in.-dia. straight bit in a table-mounted router and clamp a stop block to the router table's fence to stop the grooves, 1/4 in. from the dovetail shoulder on the sides and 3/16 in. from the front of the guide blocks. Be sure to cut all the grooves from the bottom edges of the parts so they line up with each other. Make a single pass to cut the grooves in the drawer sides and then nudge the fence back about 1/32 in., indicated in the drawing, and run the guide blocks; this will raise the drawers just a hair to ensure that the sides don't drag on the bottom shelf. Round the front end of the drawer runners to fit the radius of the stopped grooves and glue the runners into the guide block grooves. Now you can glue up the drawer. However, if you're going to stain the drawer front but not the drawer sides, stain it first before gluing the sliding dovetails.

After the glue sets, slide the drawer and the guide block assemblies into place to check their fit. Remove the assemblies and make any necessary adjustments. I only glue the first 2 in. of the guide blocks to the case and then secure their back ends with screws in elongated holes to allow the case sides to expand or contract. Instead of clamps, I use the drawer itself to press the guide blocks against the case sides until the glue sets by wedging Formica shims between the drawer sides and the guide blocks above and below the runners. Then, I remove the drawer and screw in the backs of the guides.

To prepare the piece for finishing, sand it to 150-grit with garnet paper, raise the grain with a wet sponge and sand again to remove the fuzz. A light coat of shellac on the edges of the case sides prevents the endgrain from absorbing too much stain. I use Behlen's dry powdered aniline stain, available from Garrett Wade Co. Inc., 161 Ave. of the Americas, New York, N.Y. 10013. After staining, apply one sealer coat of shellac and two coats of varnish, sanding between coats with 220-grit finishing paper. I rub out the final coat of varnish with mineral oil and a 3M Scotch-Brite pad and top that off with several coats of Butcher's wax, available from most hardware stores, buffed to a soft luster. Although the drawing shows a simple knob for the drawer pull, I chose a polished brass pull (also available from Garrett Wade or from Paxton Hardware Ltd., 7818 Bradshaw Road, Upper Falls, Md. 21156) to add to the style and formality of the piece.

To complete the message center, put the backing board in place and screw the plywood back to the case. Finally, drill two 3/8-in.-deep holes in the back of the crest rail so the message center can be hung on flat-head screws anchored securely in the wall. □

Luca Valentino, a graduate of the Carpenters' Apprenticeship School, teaches woodworking classes at the school and is a project manager with Rimi Woodcraft. For more information on the school, write to 140 E. 26th St., New York, N.Y. 10010.



Kirk Beaver's walnut, frame-and-panel desk, left, won first place in his region's industrial education contest. Jake Davis won the overall grand prize with his towering desk, above.

Student Desks

High school shop class on a roll

by John Moore

As a high school woodworking teacher with a background in design, I encourage my students to be ambitious and creative with their projects. No two pieces are ever exactly alike: We alter and vary the designs so each student gets design experience as well as building experience. In addition, no project is taboo. I've had students build everything from cedar chests and rocking chairs to tables, floor lamps and beds. Although many of the projects are both challenging and rewarding, nothing can quite compare to the majestic qualities of a roll-top desk. As you can see in the photos above showing three of my students' projects, roll-top desks lend themselves to a multitude of different forms and concepts, both in the exterior style and the design and execution of the interior compartments. In my 13 years at Kalkaska High School in Kalkaska, Mich., at least 30 different students have built large, pedestal roll-tops.

Most people have a hard time believing that these desks are high school shop projects. I often hear, "Even if students had the skill for these large projects, they'd never have the time to finish them." Well, that's half right. It's obvious that building desks such as these requires more than the one-hour class period each day. To accommodate the students who want to take on large projects, I often open the shop in evenings and on weekends so they can work an extra 10 to 20 hours a week. This enables them to complete their projects within one school year, which is a stipulation for entering

the work in the annual regional contest sponsored by the Michigan Industrial Technology Education Society. As for whether or not high school students can develop the skill to build fine furniture, I'll let the awards won at the contests and the pictures here attest to that.

Constructing a roll-top with curved sides—Our desk designs are developed quite spontaneously, beginning with small sketches to explore ideas. After establishing the overall style and shape of the desk, we begin to consider how to construct it by concentrating primarily on the dust panels, which ultimately determine the shape and size of the entire desk. Using the original sketches as a reference, we make a full-scale paper pattern of one of the dust panels. From this pattern we work out the dimensions for the pedestals and then, step by step, for all the other parts of the desk. This way, the dust panels become the starting point and first building block of all the desks we build, enabling the students to get a grasp on such a large undertaking. But when the pedestals have curved sides, like James Green's desk in the photo on the facing page, the dust panels aren't just used to determine the desk's size and dimensions; they are also the form over which the curved sides are constructed. The drawing on the facing page and the following brief explanation illustrate how Green constructed the pedestals for his desk with a single curved panel on each pedestal. Other students have built desks with both



It took James Green a lot of after-school and weekend hours to build his prize-winning, contoured roll-top desk, above. Moore says that people find it hard to believe that the students can complete their projects in one year.

sides of the pedestals curved using the same methods.

After constructing the dust panels as shown in the drawing, random-width boards are glued up to make the flat, inside panels. The flat panels are first scraped and sanded to even out the joints between the laminations, and then squared up and crosscut to length, along with enough of the random-width stock, to make the curved panels. Next, the flat panels and the stock for the curved panels are dadoed to receive the dust panels. The dadoed, curved-panel stock is then ripped into 1-in.-wide strips and each strip is jointed along both edges to 3° or so, depending on the radius of the curve as defined by the dust panels. Our curves are usually not circle arcs, so the strips have to be individually fitted along the dust panel curve and numbered so they can be glued up in the proper order. Then, the corner posts that cap the ends of the panels are milled out and shaped to conform to the curved sides and to provide a transition into the eventual drawer front shape.

Since all the parts that make up the pedestals—the corner posts, the strips for the curved panel, the flat panel and the dust panels—are glued up in one operation, dry-clamping them together with belt clamps is essential to make sure everything fits. Then, the pedestals are glued and belt-clamped together with care taken to be sure that the drawer openings are square. The next day the clamps are removed and the curved sides are smoothed out and sanded with a body-grinder type disc sander. A note of caution is in order concerning gluing the pedestals together. If you don't have complete control of the humidity in your shop, I advise against gluing the curved-panel strips directly to the dust panel dadoes. Instead glue the plywood back panel into the corner posts and dowel the front of each dust panel into the corner posts. If you leave a little space at the back of the dust panels, the sides will then be able to expand or contract without splitting or buckling. We usually glue the dust panels into the dadoes in the strips and have never had a problem with sides splitting later. But then again, I've taken great pains to ensure that our wood is very dry and stays that way in storage here at the school.

The pedestal bases are made by screwing a 1-in.-thick frame to a 3-in.-thick molded and shaped foot. Each pedestal is screwed to its base from inside the bottom dust panel. The drawer boxes are dovetailed together and the drawer fronts are stack-laminated from 1½-in.-

Curved-pedestal construction

Cutout in back side of drawer front reduces weight and provides a storage compartment.

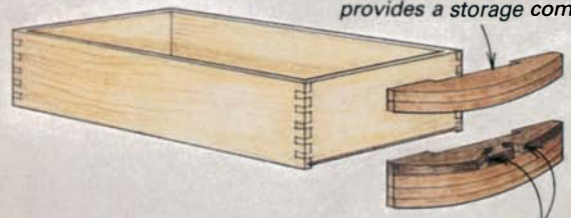

Drawer pulls are made by drilling two holes, ¼ in. dia., and bandsawing them out.

The dust panels are the desk's basic building blocks. They are made first and then the sides of the pedestal are constructed around them.

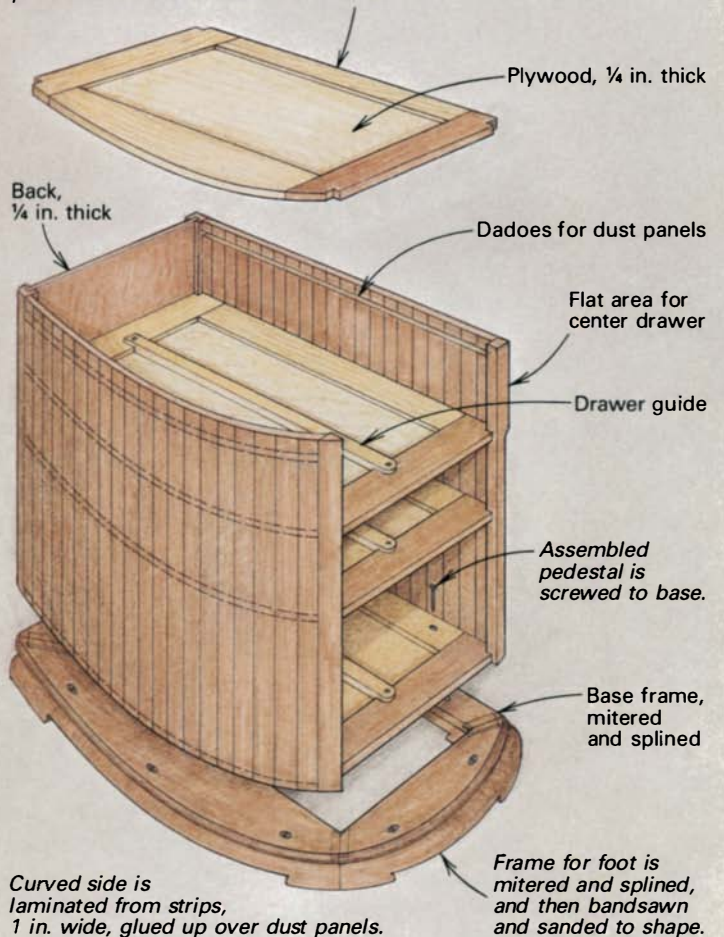

thick pieces that have been bandsawn to the desired curve. To form the drawer pulls, two holes are drilled about 3 in. apart in one of the laminates and bandsawn into the holes from its front.

The rest of the construction is similar to that of any roll-top desk. The two completed pedestals are connected with a center dust panel dadoed into the side panels, and a back panel that encloses the center drawer. Then, the desktop is glued up and bandsawn to conform to the shape of the joined pedestals. The upper sides are laminated from 4-in.-thick stock, shaped with a ½-in. round-nose bit in a high-speed grinder to match the contour of the pedestal side below and then finished up with the disc sander on the body grinder. We make our tambours by contact-cementing ¾-in.-square strips to lightweight canvas. For the sake of simplicity, the pigeon holes are glued up with a straight front edge and then the curve is bandsawn along their front. □

John Moore is a woodworking teacher at Kalkaska High School.

Making a Writing Desk

Customizing a leg-and-apron table with drawers

by Christian Becksvoort

To me there are two types of desks: storage desks and writing desks. Storage desks, slant-tops, roll-tops and other “instant offices” consist of multitudes of drawers and pigeon holes designed to house not only pen and paper, but also ledgers, stamps, files, folders, books and various office supplies. On the other hand, writing desks like the one in the photo on p. 66 are multifunctional pieces of furniture consisting of a table with a few drawers built into the aprons. These desks are ideal for the kitchen, dining or work room, or even a regular office, where you are more concerned with having a large, usable work surface than with lots of storage space.

The writing desk described in this article is basic leg-and-apron table construction. An advantage of custom-made furniture is that it can be made to fit specific requirements. I usually make this writing desk with a 36-in. by 72-in. top, but to fit into a smaller room, this one was scaled down to 32 in. by 60 in. It overhangs the base by 6 in. on the sides, 2 in. at the back and only 1 in. at the front for easier drawer access. My desk has two drawers, but the number and layout of drawers can be altered to suit the function of the table. One drawer in the middle will suit for most purposes, although you may wish to have two identical drawers fit side by side, as shown in the drawing at right. For a three-drawer table, I usually put one big drawer in the middle and two smaller ones on either side. The side drawers can then be pulled out without moving the chair while working at the table. On a kitchen table or partners' desk, the drawers can be on opposite sides by using half-depth drawers back to back or full-depth drawers side by side in a variety of configurations. Another alternative is to place the drawers on the ends of the table.

In any of these designs, I always try to make maximum use of the space available. If the distance between the aprons is 30 in., make the drawer 29½ in. deep, and then put a false back at 18 in. or 20 in. This allows ready access to a normal-size drawer, and provides an additional space at the back for seldom-used items or a secret compartment. Keep in mind that putting drawers through the aprons makes the table inherently weaker than one with four solid aprons. The writing desk is strong enough for normal use, but I advise people not to sit on it. While the addition of drawers somewhat complicates this piece, the construction remains straightforward.

I always start by gluing up my ¾-in. tabletops, as described in *FWW* #79, pp. 68-70, a week or so in advance. Then by the time I'm ready to work on the rest of the desk, I've had time to have them sanded perfectly flat on a 36-in. abrasive planer at a local millwork shop. My primary concern in gluing up tops or panels is appearance, so I arrange the boards for the best color and figure regardless of grain orientation; I've never had problems with cupping or warping.

With the top needing only final sanding I begin constructing the base, as shown in the drawing, by cutting, shaping and mortising the legs. Solid aprons are tenoned into the legs on non-drawer sides.

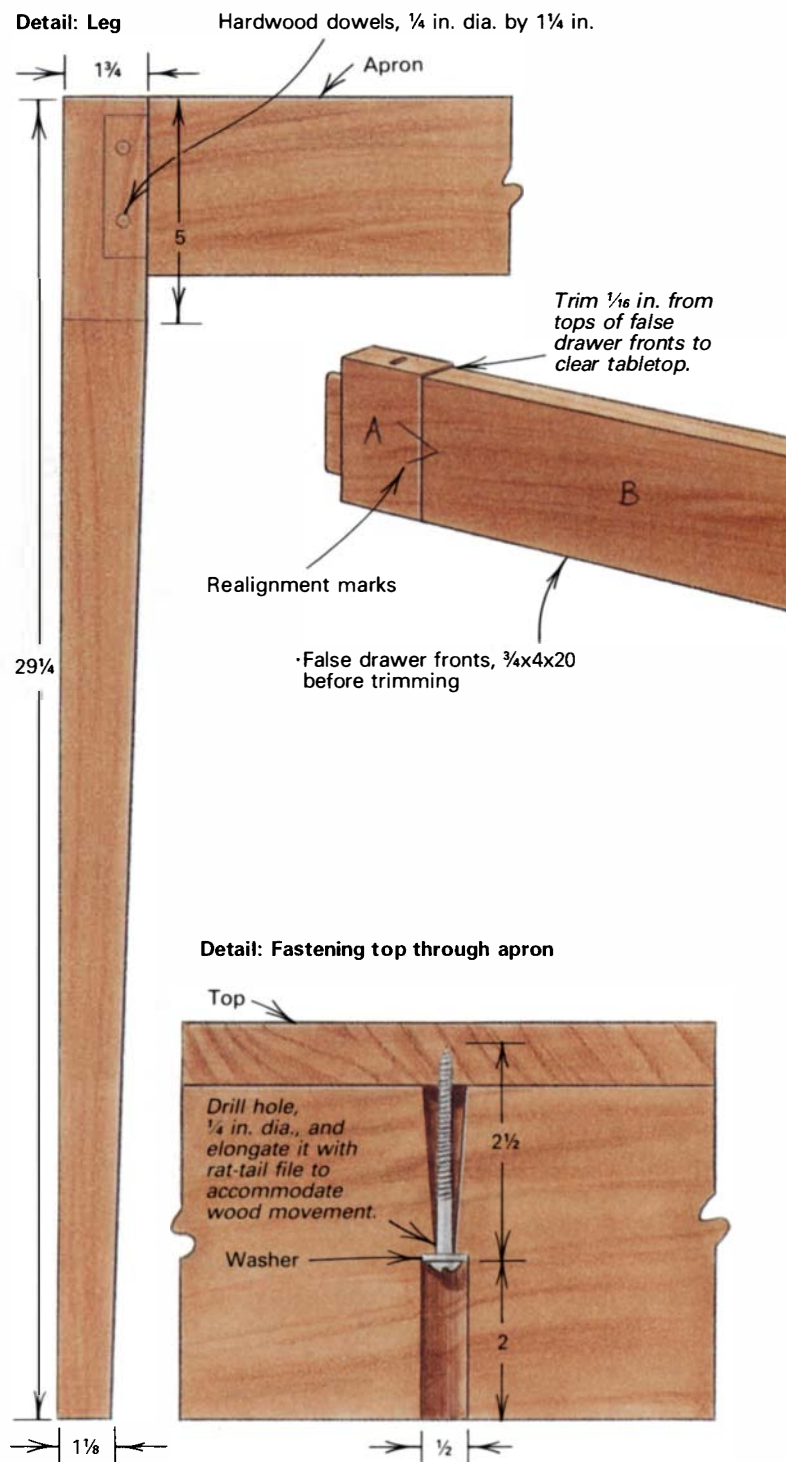

Writing desk

Top, $\frac{3}{4}$ x32x60, overhangs base 6 in. on ends, 1 in. in front and 2 in. in back.

Glue top for best figure and color match regardless of grain orientation.

Drawer dividers extend into stopped dados, $\frac{1}{4}$ x $\frac{3}{4}$ x3 $\frac{1}{2}$.

Back apron, $\frac{3}{4}$ x4x46 $\frac{1}{4}$, including tenons, $\frac{7}{8}$ in., on each end

Aprons set back $\frac{1}{8}$ in. from face of legs.

Side apron, $\frac{3}{4}$ x4x27 $\frac{1}{4}$, including tenon, $\frac{7}{8}$ in., on each end

Left drawer guide

Center drawer guide

Right drawer guide

Front frame rails, $\frac{1}{2}$ x $\frac{3}{4}$ x44 $\frac{1}{2}$

Front frame spacer block, $\frac{3}{4}$ x3x2 $\frac{1}{4}$

False back, $\frac{1}{2}$ x2 $\frac{7}{16}$ x18 $\frac{1}{4}$

Back, $\frac{1}{2}$ x2 $\frac{7}{16}$ x18 $\frac{1}{4}$

Side, $\frac{1}{2}$ x2 $\frac{19}{16}$ x25 $\frac{3}{4}$

Front, $\frac{1}{2}$ x2 $\frac{19}{16}$ x18 $\frac{1}{4}$

18

Drawer bottom slides under drawer back and is screwed through bottom into back.

Dado, $\frac{1}{4}$ in. by $\frac{1}{4}$ in., on sides and front for drawer bottom.

Drawer bottom, $\frac{1}{4}$ x18 $\frac{1}{4}$ x25 $\frac{1}{2}$, is glued-up panel.

Tenon, $\frac{3}{8}$ x3 $\frac{1}{4}$ x $\frac{7}{8}$

Stub apron, $\frac{3}{4}$ x4x3 $\frac{1}{8}$, including tenon

Top mounting holes are elongated to allow for wood movement.

Detail: Drawer guides

Left guide is a mirror image of right guide.

Hole for attaching top

Center drawer guide

Kicker, $\frac{1}{2}$ x2 $\frac{1}{4}$ x26 $\frac{1}{2}$

Divider, $\frac{3}{4}$ x3x27 $\frac{1}{2}$

Runner, $\frac{1}{2}$ x2 $\frac{1}{4}$ x26 $\frac{1}{2}$

Right drawer guide

Kicker, $\frac{1}{2}$ x1 $\frac{1}{2}$ x26 $\frac{1}{2}$

Divider, $\frac{3}{4}$ x3x27 $\frac{1}{2}$

Runner, $\frac{1}{2}$ x1 $\frac{1}{2}$ x26 $\frac{1}{2}$

Dividers protrude $\frac{3}{4}$ in. in front to fit flush to front frame rails and spacer blocks, and $\frac{1}{4}$ in. in back to fit into stopped dados in back apron.

Aprons on sides that will receive a drawer are crosscut into the appropriate sections to form false drawer fronts and stub aprons, which are then tenoned into the legs. Next, I make a front frame of rails and spacer blocks, as shown in the top photo on the facing page, and screw it into the back of the stub aprons, for a solid connection across the front of the table, to prevent racking or splaying of the legs. Drawer guides are constructed as shown in the detail in the drawing by adding kickers to the top and runners to the bottom of a divider to support the drawers and further increase the rigidity of the table. With the base assembled, I attach the top, make the drawers and then attach the false drawer fronts to complete the table.

Cutting and shaping the legs—The legs on most tables are a great deal larger than necessary to support the loads placed on the tabletop. In my designs, I concentrate on developing more delicate legs that will still support any expected loads. The tapered legs of this table work well with the overall dimensions, creating a light, yet solid effect. To ensure that all legs will be the same length, I crosscut $\frac{3}{4}$ stock to a length of $29\frac{1}{4}$ in. before ripping four pieces to $1\frac{3}{4}$ in. square (see drawing detail). Next, I orient the best figure and color to the outside surfaces of the leg and taper the two inside faces with a jig on the tablesaw. You can also taper the legs on a jointer, or rough them out on the bandsaw and refine the surface with a handplane. Depending on your methods, you may want to mortise the two inside faces prior to tapering. I use a slot mortiser that allows me to make one setup and then quickly cut all my mortises the same, although a router and jig or a drill press can be used.

Apron design and installation—The aprons also must harmonize with the other table components and I've found that a 3-in.- to 4-in.-wide apron provides adequate strength and avoids the bottom-heavy look of a 5-in. apron. I begin by first ripping my $\frac{3}{4}$ -in.-thick apron stock to width, and then crosscutting the two side aprons and the back apron to length. The drawer apron is cut slightly long so I can reposition the drawer fronts and stub aprons to minimize the sawkerfs between the individual pieces. By working from the center to both ends, I maintain the selected grain pattern and have enough stock at each end to tenon the stub aprons. First, cut the drawer apron in half and reposition the two halves end to end. Mark the two drawer fronts to either side of the center cut, leaving 4-in.- to 5-in.-long pieces on each end, and crosscut the drawers fronts. Now, reposition all the pieces next to the back apron, and mark and cut the two stub aprons so the four separate pieces are exactly as long as the back apron, including tenons. I later disc-sand the ends and joint the tops of the false drawer fronts to allow about $\frac{1}{16}$ -in. clearance at the top and sides. Finally, I draw realignment marks and label the pieces A, B, C and D, as shown in the drawing. This ensures that they stay in the correct order and the grain forms a continuous pattern, making the drawers almost undetectable in the finished table (see the photo at right).

Tenons for the three full aprons, as well as the left end of piece A and the right end of piece D, are now crosscut on the tablesaw with the miter gauge and a stop block clamped to the fence. Position the stop block $\frac{7}{8}$ in. away from the side of the blade farthest from the fence and set the blade height to $\frac{3}{16}$ in. Test your setup on a piece of scrap apron cutoff, making sure the tenons fit snugly in the mortises. The shoulder is cut first by holding the apron against the miter gauge with the end butted against the stop block. After making a pass to form the shoulder, make multiple passes from the end toward the shoulder to clear away the rest of the waste. Flip the apron over and repeat to form the other cheek. Holes for attaching the top are drilled from bottom to top through the aprons, including the stub aprons A and D. All of the holes,

except those in the middle of the side aprons and the center drawer guide, are elongated with a rat-tail file in the direction of potential wood movement of the top.

The table base is ready for assembly after sanding everything to 220-grit and checking the fit of the mortises and tenons. After making sure the aprons are all in their correct positions, glue and clamp the side aprons to their respective legs on a flat surface, checking for squareness by measuring the diagonals. Make necessary adjustments before drilling $\frac{1}{4}$ -in.-dia. holes and pinning the joints with $1\frac{1}{4}$ -in. hardwood dowels, as shown in the drawing. Connect the two glued-up sides by gluing, clamping and pinning the back apron in place, again checking for squareness across the diagonals. The two stub aprons are similarly installed, but a try square is used to check their alignment.

The base is rather flimsy until the cherry frame for the drawers (shown in the top photo on the facing page) is constructed to tie the sides of the table together. I cut two strips $\frac{1}{2}$ in. thick by $\frac{3}{4}$ in. wide and the exact length of the back apron. These are then clamped, one flush with the top and the other flush with the bottom, to the backs of the stub aprons. Next, I fit a $\frac{3}{4}$ -in.-thick spacer block between these strips so that it extends from the leg to within $\frac{3}{4}$ in. of the inside edge of the stub apron. Then the parts are unclamped and glued together on a flat surface; I usually do this on the long, plastic-laminated outfeed table of the tablesaw. When dry, the frame is sanded, reclamped in its position behind the stub aprons and screwed into the back of them, as shown in the bottom photo on the facing page.

Installing drawer guides—The rigidity of the apron is increased by adding drawer guides, which are constructed of three pieces: a divider, a kicker and a runner (see the drawing). The drawer guides are screwed into the frame in front and into dados in the back apron. For two drawers, three drawer guides are required. The vertical member against which the side of the drawer slides is the divider, the bottom horizontal piece that supports the drawer is the runner and the top horizontal piece that keeps the drawer from drooping when opened is the kicker. As shown in the drawer guide detail in the drawing, the dividers protrude $\frac{3}{4}$ in. in front to fit into the frame that was added to the back of the stub aprons and $\frac{1}{4}$ in. in back to fit into stopped dados in the back apron, shown in the top photo on the facing page. Lay out the left and right dados in the back apron by measuring from the front legs to the stub apron ends, transferring these measurements and squaring lines at each end of the back apron. Then, measure $\frac{3}{4}$ in. toward the legs and draw parallel lines. To locate the center dado, find the center of the back apron, measure $\frac{3}{8}$ in. to either side of the centerline and mark out the $\frac{3}{4}$ -in. dado. Although these dados can be cut on a tablesaw prior to assembly, I



Based on Shaker designs, this writing desk is basic leg-and-apron construction with drawers built into the apron.



This framework is screwed into the back of the stub aprons, connecting the ends of the table and providing an opening for the drawers. Note the pins securing the aprons to the legs and the dados visible on the back apron that will accept the dividers of the drawer guides.

prefer to rout them $\frac{1}{4}$ in. deep, guided by a clamped-on fence, because it is easier to stop the cut $\frac{1}{2}$ in. from the bottom of the apron.

Begin constructing the drawer guides, as shown in the drawing detail, by ripping the $\frac{3}{4}$ -in.-thick dividers to the width of the opening of the front frame, which is 1 in. less than the width of the aprons. Measure the length of the dividers directly from the bottom of the stopped dado in the back apron to the back of the stub aprons. After crosscutting the dividers to length, test-fit and temporarily clamp them in place. Scribe the top and bottom of the dividers where they meet the front frame and the back apron. The kickers and runners are added to the top and bottom of the dividers between the front frame and the back apron to form the guides. Rip $\frac{1}{2}$ -in.-thick stock $1\frac{1}{2}$ in. wide for the left and right drawer guides and $2\frac{1}{4}$ in. wide for the center drawer guide. Now I unclamp the dividers and glue and nail the kickers and runners to the top and bottom of the dividers, forming a left, center and right drawer guide. When the glue has dried, countersink and fill the nail holes and sand the finished drawer guides. Then drill and countersink a hole through the middle of the center guide for attaching the top.

The drawer guides are now installed by drilling and screwing through the top and bottom of the front frame, and drilling at an acute angle through the drawer guide into the back apron. The left and right drawer guides are located by their dados and the front frame. Although the back of the center drawer guide is also located in back by its dado, the front needs to be carefully laid out. For accuracy, I measure the location at the back, from the left and right drawer guide dividers to the center divider, and then transfer

these measurements to the front frame. Consequently, if the center dado is not precisely in the middle, the drawer guides will be parallel, but not necessarily equal in width. Once the center drawer guide is located and screwed in place, all screw holes should be plugged and sanded. At this point, the top can be cut to size and its edges dressed, and then finish sanded and attached through the holes drilled in the aprons and center drawer guide. Suddenly the table becomes quite sturdy and substantial.

Making the drawers—I prefer dovetailed drawers with a false front attached, but you can make your drawers using your favorite technique. Whatever method you choose, remember the false drawer fronts fit flush with the stub aprons in front of the frame. Cut all drawer sides, fronts and backs from $\frac{1}{2}$ -in.-thick stock, as shown in the drawing on pp. 64-65. Lay out and cut the dovetail joints before dadoing the sides and front to receive the $\frac{1}{4}$ -in.-thick glued-up bottom panel. Now sand and assemble the drawers without their bottoms. Make sure the drawers fit the openings, planing any problem areas so they glide easily and smoothly.

I don't install the drawer bottoms until the false fronts are attached, so I can put the drawers in place and then work through the open drawer bottom to perfectly align the false fronts. First I rout a $\frac{1}{2}$ -in. cove into the bottom inside edge of the two fronts for finger pulls. Fit the first front, clamp it into place and then fit the second front. I like to leave a $\frac{1}{16}$ -in. gap between the drawer and the top and $\frac{1}{16}$ in. between drawers and stub aprons. All four members must be flush on bottom. The actual trimming to obtain a clean $\frac{1}{16}$ -in. gap is done with a disc sander or a fine-tooth blade on the tablesaw. In either case, undercut the ends 4° to 5° because a good drawer fit requires some side clearance and the undercut will keep the drawer fronts from hanging up on adjacent members. Once both fronts are fit and clamped into place, I drill from the inside of the drawers for six screws each. These screws are not plugged in case any adjustment of the false fronts should ever be necessary. With the false fronts screwed in place, slide the bottoms into their dados and screw up through the bottoms into the backs.

Remove the top and drawers for a final light sanding and the finish of your choice. I generally prefer Watco oil (available from most hardware or paint supply stores), but if the table is more likely to see hard use, I will use a lacquer or varnish for a more durable finish. □



The drawer framework is screwed directly into the back of the stub aprons to keep the legs from splaying or racking.

Christian H. Becksvoort builds custom furniture in New Gloucester, Maine, and is a Contributing Editor to FWW.

Building a Wooden Hygrometer

Measuring humidity's dramatic effect on wood

by Warren W. Miller

Most woodworkers are well aware that wood moves with seasonal humidity changes, but few have a convenient way to measure moisture. You can get a rough idea by noting the relative humidity (RH) levels reported on your local weather station or you can buy an instrument called a hygrometer, which measures the amount of moisture in the air. But, since each species of wood expands and contracts at a definite measurable rate, I decided to use this natural relationship between wood movement and moisture as the basis of my own shop-built hygrometer.

My instrument consists of four pieces of wood: a laminated strip that bends with changes in RH, a clamp that anchors one end of the strip, a scale at the free, moving end of the strip, and a strut that connects the clamp and scale, as shown in the drawing on the facing page. The hygrometer looks simple, but it graphically demonstrates how RH causes wood movement by changing wood's moisture content (MC).

Relative humidity's effect on wood—Ignoring the effect of humidity on wood can create problems. Chairs, once tightly joined together in the workshop, become loose and wrack during winter's low RH. Door panels may buckle during damp weather or split during dry weather if they're fit too tightly or inadvertently glued into the door's rails or stiles.

The amount of movement can be significant. Increasing the MC of white oak from 5% to 13%, for example, causes a 2% increase in the width of a flatsawn board; that's $\frac{3}{16}$ in. in a 10-in. board! Now, that 8% difference in MC happens when RH increases from 30% to 75%, a 45% change that's a common annual occurrence in many locations. A flatsawn piece of redwood, on the other hand, moves less than 1% across its face during the same change in RH. In general, softwoods are more stable than hardwoods. For more on moisture's effect on wood movement, see Bruce Hoadley's book *Understanding Wood* (The Taunton Press, 1980).

Within any one species, movement due to changes in RH is virtually zero along the grain compared to across the grain. Because of these predictable, moisture-related changes, I was able to base my wooden hygrometer on the same principle as some thermometers employing a thin bimetal strip laminated from two metals that move differently when the temperature changes. Instead of a bimetal strip, the wooden hygrometer has what I call a "biaxial" strip: two wafer-thin laminates, one ripped on the longitudinal-grain axis and the other crosscut on the end-grain axis.

How biaxial laminates move—My laminated strip moves as MC levels vary because of the different dimensional changes of the two laminates. The end-grain changes much more than the virtually stable longitudinal-grain that it actually bends the longitudinal-grain strip.

My hygrometer's biaxial strip is cherry, but most domestic hardwoods will do as well. With a 30% change in RH, the end-grain cherry strip will change dimension about 1½%, or about $\frac{3}{32}$ in. in 10 in., making for dramatic strip movement. As previously discussed, softwoods are less affected by moisture changes than hardwoods, so they are a poor choice for a biaxial lamination since strip movement would be so subdued.

You should be sure to saw the end-grain laminate from a flat-sawn board, where the annual rings are more or less parallel to its width. A quartersawn board, where the annual rings are more or less perpendicular to the board's width, shrink and expand only one-half as much as a flatsawn board of the same species. This makes quartersawn lumber ideal for woodwork, for which stability is important, but a poor choice for our hygrometer, for which movement is desirable.

Using a thin-kerf ATB carbide blade in the tablesaw and a shop-made narrow-gap saw table insert, I ripped and crosscut the $\frac{3}{64}$ -in.-thick strips of cherry. This proved to be the thinnest section of a cross-grain strip capable of bending freely without breaking.

Laminating the strip—Since the hygrometer's strip should be straight when the RH is near 50%, be sure to laminate it when the RH in the shop is close to 50%, as reported on your local weather forecast. When laminating, avoid filling the open pores of the end-grain strip with glue. The end-grain surface will readily absorb glue, and this could hinder its ability to absorb moisture. To avoid this problem, I use a thick, viscous epoxy and take care to spread a thin coat only on the longitudinal-grain surface before pressing the laminates together. Applied this way the glue acts as a surface treatment and little of it is absorbed by the endgrain. Care should be taken to keep the strip clean and free of moisture-blocking substances, such as oily fingerprints. And, of course, no finish should be applied to the raw wood. After wrapping the laminates in wax paper, clamp the assembly between strips of wood and set it aside to cure overnight.

When the glue has cured, scrape and sand the excess from the edges of the biaxial strip and assemble the hygrometer as shown. The calibration clamp is a 1-in.-long piece of 1-in.-dia. dowel that is inserted into a 1-in.-dia. hole in the bottom of the strut. Kerf the dowel to accept the laminated strip, which is secured with a set screw. The strut also has a thin kerf and a screw tightens the clamp in position after the instrument has been calibrated. The strut, which is longer than the strip, is dadoed for the scale, as deep as the scale is thick, near its top (see the drawing).

The required length of the scale will not only depend on the wood species of the strip, but also its length and thickness and the amount of end-grain glue absorption. For the instrument in the drawing, the free end of the laminated strip moves about 6 in.

A wooden hygrometer

Calibrations for relative humidity (RH)

Radius, 8 in.

Scale is white-faced hardboard, $\frac{1}{8}$ in. thick by $1\frac{1}{2}$ in. wide.

between very low and very high humidity. Since calibrations and the final size will depend on how much the strip bends, temporarily secure the scale in the strut's dado before making any marks on it or cutting it to size. Tighten the biaxial strip in the calibration clamp and then temporarily tighten the clamp in the strut so the strip points straight up the strut's midline.

Calibrating the hygrometer—The hygrometer is calibrated by subjecting it to a few known, controlled humidity levels in an airtight chamber. The biaxial strip will bend until it stabilizes at each humidity level so you can locate each reading on the scale. Once you've established two or three levels, you can divide the scale into equal increments to establish additional levels.

Accurately controlling humidity requires a shopmade, air-tight chamber and a chemical system that produces a predictable RH level. My chamber was an inverted glass baking dish sealed to the enameled top of my washing machine with tape, although any smooth, shiny surface would have worked.

Begin calibration by placing a dish of plain water in the chamber, along with your wooden hygrometer, and in time the entrapped air will stabilize at 100% RH. As the wood's MC changes, in this instance because it's absorbing moisture, the strip begins to bend with the end-grain side of the strip on the outside of the curve. Leave it until there is no more apparent movement in a six-hour period and then temporarily mark the pointer position on the scale.

To get a second reading, repeat the process, but substitute a calcium chloride chemical solution for the plain water. Anhydrous calcium chloride, such as commercial snow melter, is safe to handle, inexpensive and available in many hardware stores. Since different salts produce different results, be sure you get calcium chloride (CaCl_2) and not rock salt (NaCl). In a glass jar, dissolve a handful of the calcium chloride in about half its weight of water. Heat the solution by placing the jar in a pan of hot tap water, and then loosely cover the jar and leave it overnight to cool. A large crop of white crystals of the hydrate ($\text{CaCl}_2 \cdot 6\text{H}_2\text{O}$) should separate in the dish. If they do not, reheat the solution and add more calcium chloride. Transfer the crystals and some of the solution to the dish in the humidity chamber, add the hygrometer and seal the chamber. The RH of the atmosphere in the chamber will stabilize at 32%. As it does, the strip will bend toward its end-grain side, with the longitudinal grain on the outside of the curve, and establish a new position on your scale. Wait until there is no more movement, as before, and then remove the hygrometer and cover the chamber for final calibration.

Now replace the preliminary calibration marks with permanent ones. I've found that the scale is very nearly linear, meaning each 10% increment is equal. Determine these increments by bending a thin, supple measuring scale along and adjacent to the scale's arc;

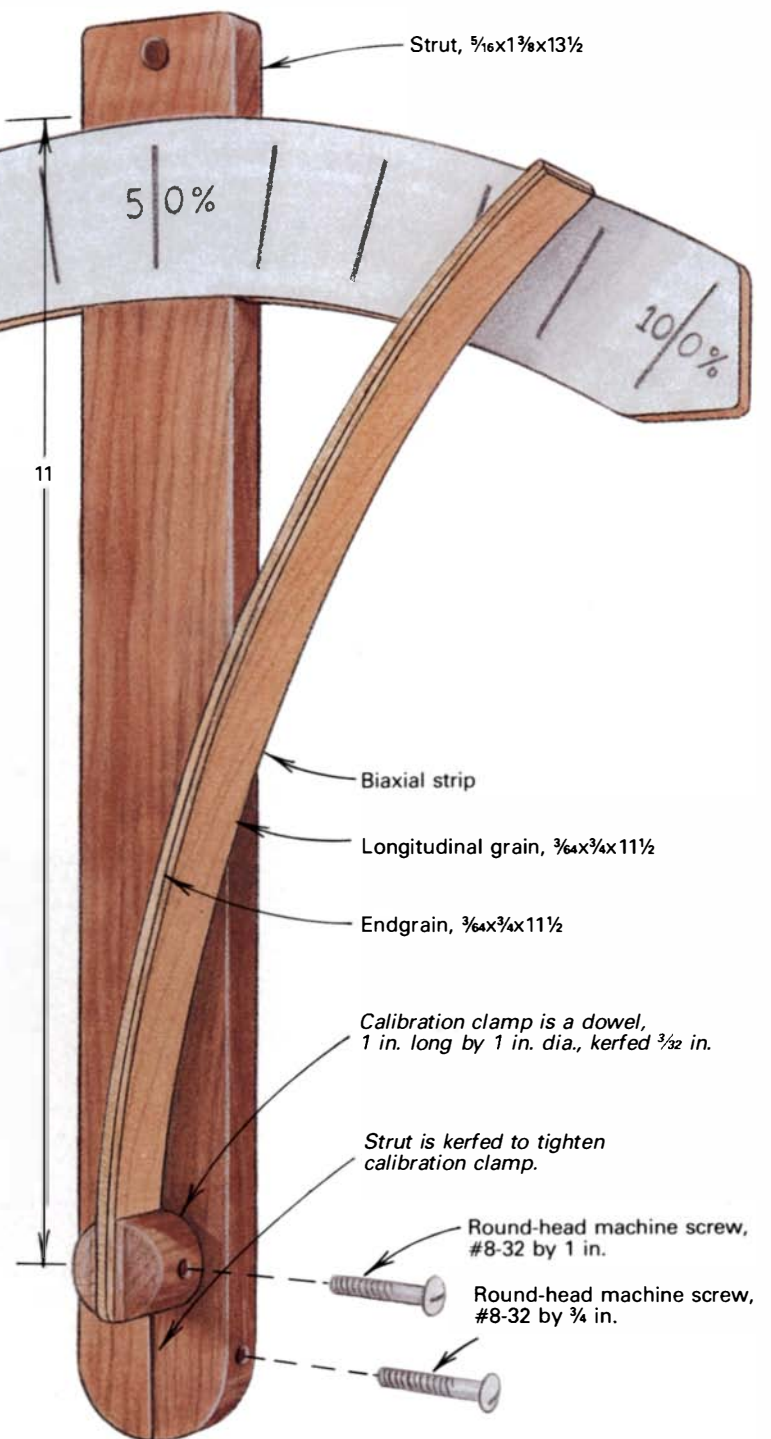

be sure to note the length of the arc between the 100% and 32% marks and divide it by 6.8. For instance, if there are 7 in. between the 100% and 32% marks, 10% increments equal 1.03 or one every $1\frac{1}{2}$ in., which is set on a pair of dividers and stepped off on the scale. Now, establish permanent marks at each 10% increment between 0% and 100%, but don't erase the temporary 32% RH mark until after you've fastened the scale and rechecked the calibration.

The next step is to permanently fasten the scale to the instrument's strut. Trim the scale's ends symmetrically, leaving some material beyond 0% and 100%, and permanently glue it in the dado with the 50% calibration mark on the strut's midline. Finally, return the hygrometer to the chamber, which is still set up for 32% RH, let the strip stabilize, turn the calibration clamp until the strip is pointing to 32% and tighten the clamp in the strut. Your instrument is calibrated and ready for use! □

Warren Miller is a retired chemistry professor whose woodworking shop is in State College, Pa.



This inkstand box, which is approximately 6¾ in. high, 20 in. wide and 13¼ in. deep, is based on Islamic art (Alhambra Palace in Granada). Cut piece by piece, the marquetry is of kingwood and arranged as suns, and inlaid into a brass grill. The interior is from moiré satinwood and amaranth. The artisans who constructed the box carved their initials inside the cover.

The design below is an example of the way some contemporary artisans employ ancient marquetry techniques to make attractive modern compositions. Despite the long tradition of marquetry around the world, today's practitioners contend that the decorative possibilities of the art form have not been exhausted, especially in light of plastics and other high-tech materials that are now available to marqueters. Made from multiple sheets of sycamore, amaranth, coral and satinwood, this elliptical casket represents an abstract design. It was designed and executed by students of the Ecole Boulle, and it is 9¼ in. high, 5½ in. wide and 3¾ in. deep. (Photo: J.P. Vial).



Left: This fantasy subject, by an Ecole Boulle student, is made from barwood, blackened pearwood and blue-dyed sycamore. The flowers are from amaranth, the butterfly from boxwood, the tree from stained bird's-eye maple and the background from flecked sycamore tinted silver-gray. Using



dyed veneers enables the marqueter to enrich the overall piece without necessarily increasing the decoration. (Photo: B. Novi). Right: Constructed in 1976, this stereo cabinet has marquetry motifs. Notice the contrasting darker and lighter veneers typical of the period.

Marquetry

Decorating with a palette of colored woods

by Pierre Ramond



Above: This 25½-in. by 24½-in. piece was created in classes on perspective and executed by Ecole Boule students. The sky is Brazilian rosewood; the dam is tulipwood and amaranth; the skeleton is West Indian boxwood, Ceylonese satinwood and pearwood; and the rocky cliffs are figured mahogany, walnut and macassar ebony. The veneer is in natural colors. (Photo: B. Novi). Below: More evidence of dyed wood that was used in marquetry are these ceiling tiles, created by Michel Lefèvre, that are made from sycamore that's been stained silver-gray.

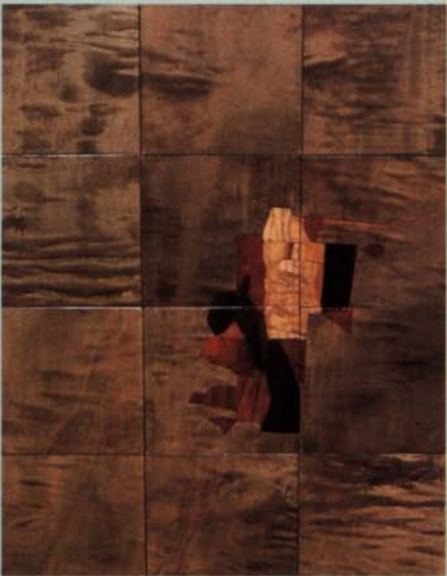

Most furniture made by contemporary designers was rather conventional, although it was enriched with beautiful marquetry. The coffee tables, shown above and below, represent rather unique, and somewhat abstract, designs. The original ideas and designs are by Luis Ansa, who was inspired by the Cubist School, and the marquetry is by Pierre Ramond. (Photos: Peter Shummer).



Marquetry is the art of painting with wood. Also called in-tarsia or inlay, it encompasses making pictures and geometric designs with thin slices of colored wood, shell and other precious materials. It is a popular technique for decorating the smooth surfaces of pieces of furniture, as well as a versatile means of creative expression.

The art of marquetry is ancient and dates back to marble incrustations in the palace of King Mausole in 350 B.C. For many centuries after that time, marquetry was centered in Paris, although English and German cabinetmakers were actively decorating furniture with marquetry as well.

In North America, marquetry was not as popular as in Europe. The decoration of 18th-century furniture was taken from the Eng-

lish and Colonial styles, but the shapes and designs were far less elaborate. Much of this early American marquetry was made by a constituent of cabinetmakers in Boston, Mass., who found wood plentiful in this country and worked with sculptors, gilders, turners, upholsterers and lumbermen to cut and prepare veneers.

Between 1788 and 1810, "Early Federal" furniture evolved, influenced by George Hepplewhite's and Thomas Sheraton's styles. The "Later Federal" period (1800-1840) boasted pieces veneered with light-color woods. Since many more European cabinetmakers settled in America during the mid-19th century and onward, some of the more popular European styles, such as Gothic, Rococo, Renaissance and Louis XIV, were very much in fashion in the United States.

In the years between the two World Wars, many cabinetmakers

The marquetry in the chest, right, was cut in veneer from “luxury” woods of exceptional quality: kingwood and rosewood from Madagascar, and brass. Like many marquetry pieces, this is an interpretation of a drawing. In keeping with the originality of the drawing by Cornelius Escher, the tracing silhouettes the figures the same way on the top and bottom and the reverse way in the center. This type of composition can be executed in the 17th-century technique of Andre-Charles Boulle, who developed compositions made from wood, shell and metal, cut in superimposition, and assembled in positive and negative. Here the rosewood is superimposed on the brass, and obtains identical patterns at the same time, but with the contrasts reversed. After the pieces of marquetry were veneered on the box, the details of the figures were engraved with a burin. The engraved figures are more visible on the brass.



continued working and adopted the Art Deco style. Although the merit of the artistic taste during this period is questionable, the marquetry created was of a very high technical standard. In fact, to cut the very fine grill work that was essential to cloisonné motifs, experience and great manual dexterity were required. Works by Jacques-Emile Ruhlmann with their delicate ivory interlacing are proof of such skill. (For more on Ruhlmann's work, see *FWW* #51, pp. 35-37.)

While the aesthetic quality of the style may be disputed, the artisans were still able to craft superb copies, faithful to the ideals of their predecessors. Since the last century, there has been considerable mechanical progress: The workbench is in its most advanced form and the pedal or electric scroll saw is able to cut a number of veneers simultaneously, producing several copies of a marquetry motif. Many tools, including the small circular saw and trimmer, accelerated the use of marquetry and improved the precision of the arrangements, thereby lowering the cost by increasing the output.

The industrialization of recent years and the progressive disappearance of artisans, however, have discouraged the survival of marquetry. After World War II, furniture was made in mass, and marquetry was not frequently included. It was at this time that marquetry decoration was adapted in “Moustache” style furniture. The furniture made during this period was rectilinear and rather conventional, although it was enriched with beautiful veneer work. Cabinetmakers produced large quantities of furniture that was almost identical, but was covered with a different veneer, that was either dark (Indian rosewood or ebony) or blond (Baltic birch, bird's-eye maple or sycamore), the paleness of which was accentuated by applying hydrogen peroxide before varnishing.

Fretwork medallions were incorporated into doors of wardrobes and cupboards and on tabletops and headboards. The main part of this decoration was in speckled, moiré, marbled or flamed veneer, arranged simply or with a background effect, such as mosaic squares or circles. The frame was either pierced or fretwork and made from striped veneer of the same tonality, contrasted by a fillet that was 1mm or 2mm wide. This fillet was commonly made from boxwood or sycamore on a darkened-wood ground, or amaranth, ebony, pearwood or hornbeam stained black and inlaid into light furniture.

The elements of character—Wood is the most frequently used material in marquetry. Although a wide assortment of natural-color wood is available, an infinite variety of hues are also possible with

dyed wood. Veneer manufacturers classify wood into three categories: exceptional-figured qualities, which includes walnut, elm, oak, tropical wood, nearly all mahogany, avodiré, makoré and teak; luxury wood, which includes tropical wood that provides veneer that is moiré, waved, speckled or flamed, as well as maple, European cherry, tulipwood, kingwood, rosewood, amaranth, satinwood and ebony; and common wood, which is used for plywood and industrial veneer, and includes poplar, beech and most of the species in the other categories if they don't contain any unusual characteristics. All wood veneers composing a marquetry are selected from exceptional-quality wood, usually from the luxury category.

However, it is not uncommon to see imitations. Plastic laminates with a wood design or geometric composition on reconstituted veneer are easily identified as false marquetry. But new techniques, like transferring, make the expert's task of recognizing a false marquetry piece even more difficult. This method consists in making a genuine motif in wood, which is cut out, and then inlaid by a marqueteur. It can be photographed and reproduced, sometimes by the thousands. The photograph, printed on paper or vinyl, is glued onto the piece of furniture, and a coat of polyester or polyurethane varnish eliminates any trace of lamination. Stenciling is another method and involves decorating pieces of furniture with paint that commonly imitates boxwood, ebony, mother of pearl and copper bandings. When the work has been done carefully, stenciling is a fairly good and undetectable method of reproduction.

In recent years, the increasing use of plastic laminate and the popularity of lacquered furniture have seriously impacted the use of marquetry. Louis XV, Louis XVI and Charles X furniture has been in demand, and the use of marquetry in these pieces has been maintained. A few contemporary artisans have created modern compositions decorated with new and different materials. However, the true marquetry craft is so relatively unknown and the standards of craftsmanship have declined that the decorative possibilities offered by this art form are not fully utilized. □

Pierre Ramond is a teacher at l'Ecole Boulle, the University of Paris I and Paris IV and at the Sorbonne, as well as at the French Institute for the Restoration of Works of Art. This article has been adapted with permission from the new English-version book, Marquetry, ©1989, which was published jointly by Les Editions H. Vial and The Taunton Press.



The viscosity of gel finishes varies from the thick, paste-like consistency of Bartley's Paste Varnish and Stain, top left, to the pourable gel of Flecto's X-3D Wood Stain, top right. Nonetheless, all have been blended with thixotropic, or thickening, agents to keep the pigments, resins and solvents from separating. Since stirring is not required and convenience for the do-it-yourselfer is one of their selling points, the brands at left package their gels in plastic squeeze bottles.

Gel Stains

Producing even color with less mess

by Jim Boesel

When I first noticed advertisements for new, improved gel stains and clear finishes, I was skeptical, but not surprised. In the last year or so, everything in my bathroom, from toothpaste to shaving cream, has “gelled,” so why shouldn’t this new advertising buzzword make its way into the shop? Next year, I had speculated, they’d be coming out with new, improved polyurethane *light*: covers great, less filling.

After awhile my skepticism gave way to curiosity and I tried these gelled finishes. They are available in the usual variety of wood stain colors, which can be intermixed to produce additional shades. There are also white and clear gels that can be tinted with most pigments, including Japan colors, artists’ oils and universal

colorants from your local paint store. White gels can also be thinned to create a limed or pickled effect. The latest entries in the gel marketplace are premixed pastel colors that subtly tint tight-grain woods and color the open grain in woods such as oak and ash.

To my surprise, these gels delivered what they promised. They were easy to apply, with little mess. They produced an even color coat without requiring you to continually stir the pigment into suspension. They were fast drying and didn’t raise the grain enough to require sanding between coats. And they covered more area than a comparable portion of conventional oil-base stain. I was also surprised to learn that gel stains are not new. As Dick Fitch, finishing consultant to The Bartley Collection Ltd., pointed out, pigmented

stains in paste form are at least as old as war paint, and wood finishers have been using them for centuries. Heavy-bodied wiping stains, which are thickened with additives that act something like cornstarch in gravy, have been a staple in professional finishing shops for decades. The thick consistency of these wiping stains keeps the pigment in suspension to provide predictable and repeatable results, but they have never been readily available to the weekend woodworker. Then about 20 years ago, gel stains made their appearance on the market. These new wiping stains owed their thick viscosity not to the addition of a thickening agent, as the earlier wiping stains had, but to rheology, the science of the deformation and flow of matter.

Thickness through thixotropy—Gel stains consist of basically the same ingredients as conventional oil-base stains: pigments suspended in a vehicle of alkyd resins (often alkyd-modified linseed or some other vegetable oil), driers and mineral spirits. Gels contain about twice as much pigment and resin as regular stains, but this higher solids content has little to do with their thicker consistency. So, what makes gel stains different from conventional wiping stains? The gels are thixotropic. Webster defines thixotropy as the property of various gels of becoming fluid when disturbed, as by shaking. In other words, gel stains are thick to begin with, but when disturbed, either by shaking, stirring or even just the action of applying them with a cloth, they become fluid and easy to work. When the materials are left alone again, they return to their gel state. In contrast, a conventional wiping stain will stay thick unless it's thinned with solvent.

Gels are made thixotropic by adding a polyamide-modified thixotropic alkyd resin and/or other thixotropic agents (such as bentonite clay) to the usual recipe of pigment, resin, driers and solvent. These ingredients are placed in large drums and then mixed together for about 20 minutes by a high-speed dispersion machine that looks just like a giant milk-shake mixer. The mixer blades spin at about 3,000 RPM and blend the ingredients evenly throughout the mixture. When the mixing stops, weak hydrogen bonds are formed between the thixotropic agents and the other ingredients, binding the mixture together to a uniformly thick consistency, which can be varied from a pourable gel to a thick paste. These weak hydrogen bonds break down when shear forces are applied, such as the mechanical action of applying the gel with a cloth, and then re-form shortly after the rubbing stops.

Applying gel stains—It's safe to assume that the proliferation of gel stains in the past few years is directed at the convenience or do-it-yourself market. Gels are well suited for small projects. And because they're wiped on and off almost immediately, they are especially handy where a dust-free environment for finishing is not available. Their thick viscosity makes them great for finishing in-place vertical surfaces, such as built-in cabinets or pre-hung doors. In fact, their thicker viscosity solves most of the common complaints associated with oil-base stains. They can be applied without splattering or running and, because the pigment stays evenly blended, they produce an even color coat. In addition, their higher solids content reduces their penetration into the wood, which increases the area that can be covered with a given amount of stain and makes it much easier to control the problem of splotchy color on irregular grain.

Unfortunately, even with gels, the final finish will only be as good as your surface preparation. Staining will accentuate any scratches or rough spots, so sand all wood surfaces thoroughly. Because of their high solids content, gels will help fill wood pores better than regular stains. But if you want a smooth, highly polished finish on open-grain woods, such as oak, ash or mahogany, you must still fill the pores with a paste wood filler before staining. After sanding or filling, blow the sanding dust from the wood's surface with an air compressor and

then clean the entire surface with a tack cloth.

In preparation for finishing, gather a good supply of clean cloths; old T-shirts or terry cloth work well, but avoid any cloth that gives off lint. Brushes are handy for working the finish into intricate carvings or other tight spots. Have some mineral spirits on hand for lightening the color or blending lap marks when staining. As user-friendly as gel finishes are, don't forget that they contain mineral spirits or other solvents that are potentially hazardous. Rubber gloves are advisable and it's essential to provide proper ventilation, such as a window fan blowing out one end of the room and a door or window open at the other end.

Instructions for applying gel finishes are pretty much the same for all brands. Apply a small amount to a clean cloth and wipe it on the surface with the grain. If possible, cover a whole area, such as a cabinet side, at one time. On large tabletops and similar surfaces, work in logical areas—treat one leaf or one half of the table as a unit. You can blend lap marks with a little mineral spirits, although it isn't usually necessary if you work quickly. The recommended waiting time before wiping off the gel with another clean cloth varies from immediately to between two and five minutes. Again, when wiping off excess finish, work with the grain.

As with conventional stains, most common clear finishes can be used over gel stains that have dried thoroughly. The exceptions are brushing lacquer and other finishes containing high-boiling active solvents like ketones, which evaporate slowly and might re-dissolve the stain. The drying time before topcoating varies, depending on the final finish, but 24 hours seems to be the average. Up to 72 hours is recommended for spray lacquer.

What about the drawbacks of gels? For large areas such as a floor, it would be faster and easier to brush or spray on a liquid finish. And for most production situations, applying a gel is just too slow; they can't compete with a spray gun or dip tank for moving multiples out the door. Their lower solvent content, which prevents them from penetrating as deeply as conventional oil-base finishes, could be a disadvantage in some cases. However, this reduction in solvents is most likely one of the reasons for the finish industry's current interest in gels, because it will help them meet the tighter government restrictions on volatile organic compounds (VOCs) that have already been enacted in California and New Jersey and which promise to be the trend in the future.

So, in spite of my original skepticism, I have to conclude that for most small projects, the advantages of gels tend to outweigh the disadvantages. And if you dread the mess, and that feeling of uncertainty that often accompanies the finishing process, gel finishes might be just what you've been looking for. □

Jim Boesel is an Assistant Editor at FWW.

Sources of supply

The following companies manufacture gel finishes:

Bartley Collection Ltd., 3 Airpark Drive, Easton, MD 21601; *stains in wood tones (stain and topcoat in one) and clear.*

H. Behlen and Brothers, Inc., Route 30 N., Amsterdam, NY 12010; *stains in wood tones, white and clear.*

Fabulon Products, Box 1505, Buffalo, NY 14240; *stains in wood tones, white and tung-oil varnish.*

Flecto Co., Inc., 1000 45th St., Oakland, CA 94608; *stains in wood tones and clear.*

Minwax Co., 102 Chestnut Ridge Plaza, Montvale, NJ 07645; *stains in wood tones, white and pastels (stain and topcoat in one).*

Thompson and Formby, Inc., 825 Crossover Lane, Memphis, TN 38117; *stains in wood tones and tung-oil varnish.*

Wood-Kote Products, Inc., Box 17192, Portland, OR 97217; *stains in wood tones and white.*

A professional's gel techniques

by Gregory D. Johnson

As a professional wood finisher, I'm familiar with a large repertoire of wood finishes, from shellac and lacquer to high-tech catalyzed polyurethanes and polyesters. These finishes, which constitute the bulk of our work, are all film-type coatings that build up on the wood's surface. But now and then a piece comes through which, because of the customer's request or the style of the furniture, calls for the subtle beauty of a hand-rubbed oil finish. However, achieving a durable oil finish requires a good deal of labor, wiping each of several coats on and off. You also lose a lot of time waiting for one coat to harden before applying the next. This process can take anywhere from three or four days up to two weeks, which creates work-flow (not to mention cash-flow) and space problems for most finishing shops.

To give the customer a "close-to-the-wood" type finish without causing a backup in the shop, I've turned to paste stains and paste varnish. Compared to tung oil or Danish oil finishes or homemade oil/varnish mixtures that I've tried, paste varnish dries faster, builds faster and is more durable, while it still preserves that hand-rubbed look. Although any of the paste or gel finishes on the market will give good results, I prefer Bartley's paste stains and varnish because they contain a substantial amount of polyurethane (about 33% of vehicle solids), which increases the durability of the final finish and lets you stain and top-coat in a single step. Both the premixed stains and the clear varnish dry within four hours and can be buffed to a nice sheen after two coats.

For many pieces of furniture, such as chairs, beds and bookcases, a couple coats of paste varnish will suffice. But for a kitchen or dining room table or any piece of furniture with a flat surface that might attract an after-dinner drink or a cup of hot tea, I recommend a more durable film finish. Even with the addition of polyurethane, any finish that's wiped off almost immediately after it's applied will not build much of a film. When I want additional protection without the look of a film finish, I first brush on a sealer coat of Minwax fast-dry, semi-gloss liquid polyurethane and then top it off by rubbing on a couple of coats of paste varnish. The photos at right illustrate a test I did to see how much additional protection was gained with this sealer coat of polyurethane. The finishes looked and felt the same, but the sample that had the coat of polyurethane showed much greater resistance to water and alcohol damage.

Working with a polyurethane/gel finish: First, sand the surface well and fill or stain as needed. When the stain is dry, brush on the initial coat of polyurethane, being careful to avoid runs or drips along edges, or puddles in the corners. Often air bubbles will form right away, so without adding any more finish, brush the wet film again very lightly and with the grain to just knock the bubbles off. If there are still a few bubbles after the film begins to setup, leave them alone because further brushing will streak and damage the film. Bubbles seem to form more readily on open-grain woods, such as oak, walnut and mahogany. So when working with these woods, I first brush on a coat of polyurethane thinned 50/50 with naphtha or paint thinner to help fill the pores. Any bubbles that form with this mixture are easier to work out. I let this sealer coat dry overnight, sand it with 240-grit, 3M Trimate sandpaper (available from 3M Co., Consumer Specialties, 3M Center, Building 225-4S, St. Paul, Minn. 55144) and then apply a coat of unthinned polyurethane and let it dry overnight.

When the unthinned coat is completely dry, sand the entire surface well with 320-grit sandpaper. I prefer sandpaper because it will cut the surface flat, whereas steel wool or abrasive pads round over the dust nits or lumps in the surface. To keep paper from cutting through the film on sharp edges, I ball up used 320-grit to soften it and then flatten it out before using it. The older and more worn the paper gets, the better it is for sanding the finish on moldings and such.

If you stained the wood before applying the polyurethane and then created a large light spot by sanding too vigorously, you can repair the spot by reapplying the original paste stain. The edge of the repaired

area must be carefully blended and then allowed to dry the recommended time before another coat of polyurethane is brushed over the entire surface. If there is only minor sand-through along sharp edges, which is almost inevitable on stained furniture, I touch up the area by padding with 2-lb. shellac colored with blending powder so I don't have to delay work while the repair dries. Blending touch-up powders come in a wide range of colors and are available from Mohawk Finishing Supply, Route 30 N., Amsterdam, N.Y. 12010 and Star Chemical, 360 Shore Drive, Hinsdale, Ill. 60521. Although shellac is not supposed to be compatible with polyurethane, I've used it for small touch-ups with no ill effect.

After sanding the polyurethane with 320-grit and touching up as needed, rub the surface with 0000 steel wool until it has an even matte finish. Remember, there's only one coat of polyurethane on the surface, so go easy; then blow and/or tack-rag off the dust. Now, to give the finish the sheen of hand-rubbed oil, apply two coats of paste varnish. Allow about four-hours drying time and lightly buff between coats with 0000 steel wool.

This finish is easily maintained; I give the customer a small bottle of Oz brand furniture cream polish, available from Mohawk and Star Chemical, to be used once or twice a year. The rest of the time a damp rag is all that's needed. The finish can be repaired much as you would repair an oil finish: rub with 0000 steel wool or sand first with fine-grit paper, and then apply another coat of paste varnish. □

Greg Johnson operates the finishing shop at Wendell Castle Studio in Scottsville, N.Y.



To see how much protection one sealer coat of polyurethane provides, I made up two finish samples, left. The one on the left has one coat of Bartley's paste stain, a sealer coat of Minwax fast-dry liquid polyurethane and two coats of Bartley's paste varnish. The sample on the right has the paste stain and varnish, but not the sealer coat of polyurethane. The finishes looked and felt nearly identical. Then, I poured one teaspoon of whiskey on a rag, set a glass on it and left it for 15 hours. I also poured one teaspoon of boiling water on a rag and weighted it with a cup of boiling water for 35 minutes. Right: The sealer coat of polyurethane resisted both the whiskey and the hot water.

Building a Chest-on-Chest

A simple method for framing carcasses with solid sides

by Carlyle Lynch

With its modest proportions and uncluttered design, the chest-on-chest in the top photo at right can easily find a place in most of today's homes. Standing only 1 in. over 5 ft. tall, the chest has a friendly, unthreatening scale unlike many of its 7-ft. tall period counterparts that nearly graze contemporary ceilings and dominate an entire room. Judging by the clean lines, the good proportions and the shape of the bracket feet, this double chest was probably based on designs made by Thomas Elfe, whose work delighted the people of Charleston, S.C., during the mid-18th century.

This chest was built to the plan on the opposite page 40 years ago by furniture makers at Virginia Craftsmen, of Harrisonburg, Va., who have built reproduction furniture for many historical restorations. To avoid the problem of split sides, a common ailment of antique furniture, the designers at Virginia Craftsmen came up with a simple way to build carcass frames that allows the sides to expand and contract freely. To accomplish this, the rails that run side to side between the drawers are tenoned and glued into mortises in the sides, while the runners and center guides that run front to back within the case are tenoned, but not glued into the rails. These "dry" joints allow the sides to expand with increased humidity. In addition, the runners and guides are cut $\frac{1}{4}$ in. short to leave a $\frac{1}{8}$ -in. gap at each end, as shown in the bottom photo at right. These gaps provide space for the sides to shrink in drier conditions. Each runner is screwed to the center of the case side with a single $1\frac{3}{4}$ -in.-long, #8 flat-head screw to keep the runners from ever sagging and to resist any tendency for the sides to cup or bow.

Building the base chest—Begin construction by gluing up the base unit sides and cutting them to size as shown in the plan. Then, run a $\frac{1}{2}$ -in. by $\frac{1}{2}$ -in. rabbet on the inside rear edges for the backing. Next, make the front and back rails, drawer runners and center guides that make up the carcass framework. As you can see by the detail in the lower left on the plan, the top and bottom rails, both front and back, are dovetailed into the sides, while the other six rails that run between the drawers are mortised into the sides with double tenons. Bandsaw the dovetails on the ends of the top and bottom rails and mark the sockets from the rails onto the top and bottom edges of the sides. Saw and chisel out the sockets by hand. Cut the double tenons on the ends of the other rails with the



Pleasing proportions combine with a simple, unadorned design to give this chest-on-chest a friendly, informal feeling. In the 40 years since it was made, the Appalachian white pine has aged to a dark honey color.

A peek inside one of the chests shows why the solid-wood sides have aged without splitting. The horizontal rails are mortised and glued into the sides but the joints between the drawer runners and rails are not glued. The runners are cut short, to give the sides room to shrink, and fastened at the center with a single screw.



CHEST ON CHEST

Measured & Drawn by Carlyle Lynch

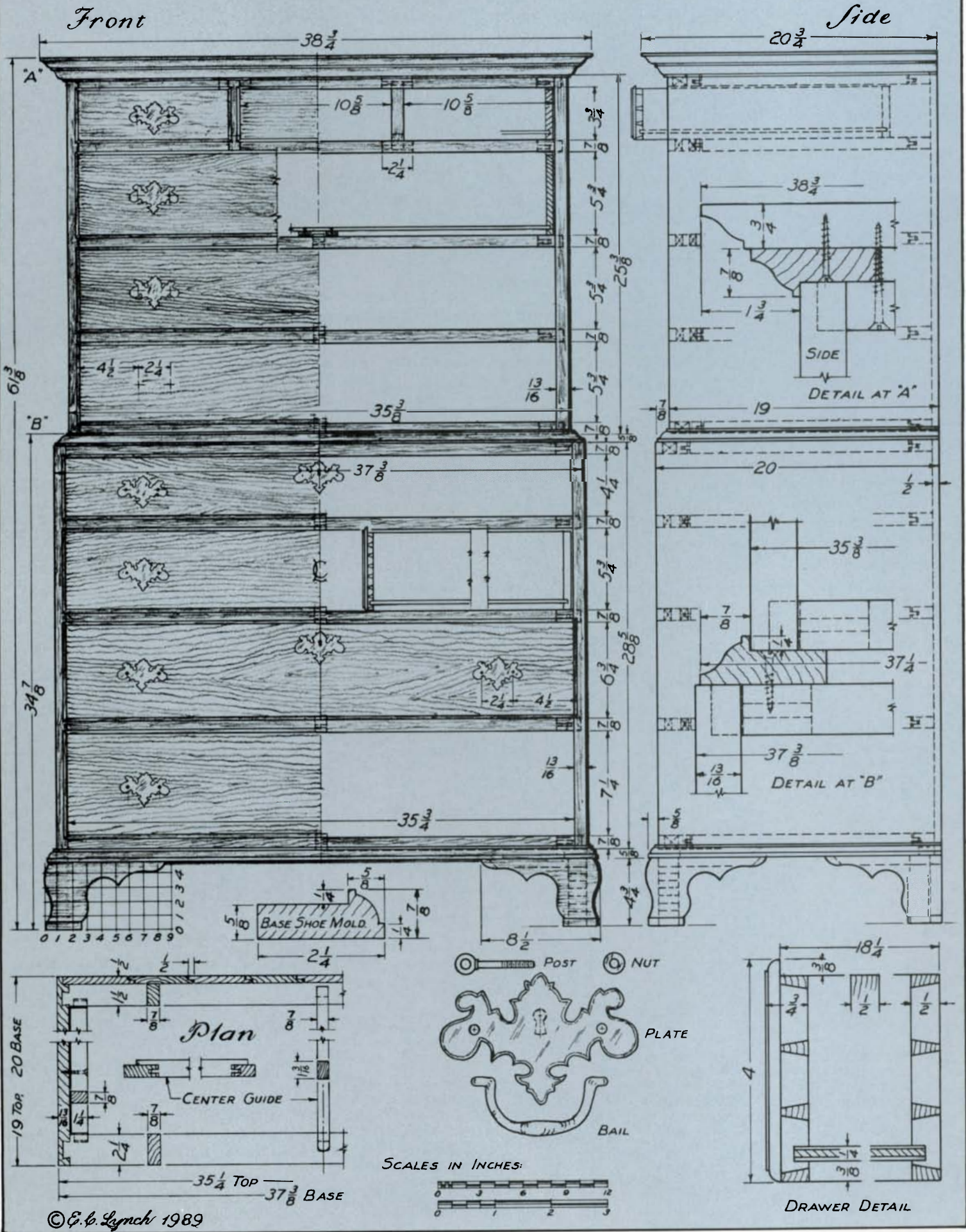

© E. b. Lynch 1989

dado blade on the tablesaw, and mark the case sides for the mortises to receive these tenons. You can chisel the double mortises entirely by hand or speed up this process by drilling out most of the waste with a Forstner or brad-point bit on the drill press. You might notice that the drawer rails on the chest in the top photo on p. 76 are all dovetailed into the sides. This is a possible variation, but when drawing the plan, I chose to go with the double tenons because they are easier to make and quite adequate for this application.

Next, cut the hardwood runners and guides to length. The runners and guides have 1/2-in.-long tenons on both ends that fit into mortises on the inside edges of the rails. The detail in the lower left corner of the plan shows how the center guides lap over the top of the rails. Determine the length of these parts by measuring the actual width of the rails and sides, but don't forget that you want a 1/8-in. gap at each end to allow the case sides to contract. I cut the cheeks on the tablesaw with a rip or combination blade first, and then change to the dado blade to remove the waste and establish the shoulders. It's a good idea to tenon the runners so their top surfaces will be about 1/2 in. higher than the rail to ensure that the drawer sides slide on the runners and not on the front rails.

The 1/4-in.-wide by 1/2-in.-deep mortises on the inside ends of the rails that receive the runners can be made by cutting a stopped dado on the tablesaw. The mortises for the guides in the center of the rails can either be made with a router, drilled and chiseled square, or chiseled entirely by hand. After dry-assembling to inspect the joints for a good fit all around, take the framework apart and reassemble it with the rail tenons glued into the mortises in the chest sides. Clamp the carcass together across each rail and check the case for squareness before placing it to dry on a flat surface.

After removing the clamps, place the chest facedown on a padded bench and measure diagonally across the carcass to double-check that it's square before installing the backing boards. The

chests get a good deal of their rigidity from the back that is nailed to the rabbets in the rear edges of the sides and to the top and bottom rails. If you choose to use solid, vertical ship-lap for the back, as specified in the plan, this is another place you must allow for wood movement. The first board should be nailed only to the rabbet in the edge of the side. The second board should overlap the first, but should not be pushed up tight to it. Use 1/8-in. spacers to hold the boards apart and nail the second board to the top and bottom rails near the overlap so it holds the first board tightly to the back rails. Then, the third board is lapped over the second board and nailed near this joint to hold it in place. By only nailing one edge of each board and leaving a 1/8-in. gap between boards, they are free to expand or contract. Continue in this way across the back and then end with a narrow board, no more than about 3-in.-wide, and nail it to the rails where it laps the previous board *and* to the rabbet in the side.

Making and installing the moldings and feet—Now you'll need to make the moldings that give a little style to the piece and provide transitions from one element to the next. There are three shoe moldings: A quarter-round at the bottom of the base chest, and two ogees, one at the top of the base chest and one at the top of the upper chest. All the moldings are made from 2 1/4-in. by 7/8-in. stock and you'll need about a 7-ft. length of each molding shape. First, shape the profile on the edges with a molding plane or shaper and then saw out the 1/4-in.-deep recess behind the profile. Miter the two base chest moldings to fit, and then glue and screw them to the rails and runners. The ogee molding for the top of the base is set in about 1/8 in. from the chest's edges; since this molding retains the upper chest, it is the gauge for determining the top unit's dimensions. Cross-grain splines are in order to reinforce these wide miters. You'll need to screw a 5/8-in.-thick filler

BILL OF MATERIALS							
Amt.	Description	Dimensions	Comments	Amt.	Description	Dimensions	Comments
Base Chest				Upper Chest			
2	Sides	1 3/16 x 20 x 28 3/8		2	Sides	1 3/16 x 19 x 25 3/8	
5	Front rails	7/8 x 2 1/4 x 36 3/4	35 3/4 s/s	5	Front rails	7/8 x 2 1/4 x 34 3/4	33 3/4 s/s
5	Back rails	7/8 x 1 1/2 x 36 3/4	35 3/4 s/s	5	Back rails	7/8 x 1 1/2 x 34 3/4	33 3/4 s/s
10	Drawer runners*	7/8 x 1 1/4 x 16 1/2	15 1/2 s/s dry mortise	10	Drawer runners*	7/8 x 1 1/4 x 15 1/2	14 1/2 s/s
4	Drawer center guides*	7/8 x 1 3/16 x 18 1/2	15 1/2 s/s	2	Drawer stiles	7/8 x 2 1/4 x 4 3/4	3 3/4 s/s
1	Dust bottom**	1/4 x 16 3/4 x 34 3/8	Nail on	4	Drawer runners*	7/8 x 2 1/4 x 15 1/2	14 1/2 s/s
1	Back	1/2 x 36 3/4 x 28 3/8	Ship-lapped boards, 1/2-in. lap	2	Drawer side guides*	1/2 x 7/8 x 16	Glued to wide runners
1	Top shoe mold	7/8 x 2 1/4 x 38	Miter, hold back 1/8 in.	3	Drawer center guides	7/8 x 1 3/16 x 17 1/2	14 1/2 s/s
2	Top shoe molds	7/8 x 2 1/4 x 21	Miter front corners	1	Top shoe mold	7/8 x 2 1/4 x 38	Miter
1	Bottom shoe mold	7/8 x 2 1/4 x 39	Miter	2	Top shoe molds	7/8 x 2 1/4 x 20	Miter
2	Bottom shoe molds	7/8 x 2 1/4 x 21	Miter	1	Dust bottom**	1/4 x 16 1/4 x 32 1/2	Centered to fit within molding on base chest
3	Back filler strips	3/8 x 1 1/4 x 34 1/4	Base and upper chests	1	Top	3/4 x 20 3/4 x 38 3/8	Mold three edges
6	Ogee foot pieces	7/8 x 4 3/4 x 8 1/2	Or two pieces, 7/8 x 4 3/4 x 28	1	Back, ship-lapped	1/2 x 34 3/8 x 25 3/8	Random width, vertical
2	Back foot pieces	7/8 x 4 3/4 x 8 1/2		3	Drawer fronts	1 3/16 x 4 x 11 1/8	3/8-in. lips on top, sides
1	Drawer front	1 3/16 x 4 1/2 x 36 1/4	3/8-in. lips on top, sides	6	Drawer sides	1/2 x 3 3/8 x 18 1/4	
2	Drawer sides	1/2 x 4 3/8 x 18 1/4		3	Drawer backs	1/2 x 3 3/8 x 10 3/8	
1	Drawer back	1/2 x 4 3/8 x 35 1/2		3	Drawer bottoms**	1/4 x 9 7/8 x 17 3/4	
1	Drawer front	1 3/16 x 6 x 36 1/4		3	Drawer fronts	1 3/16 x 6 x 34 1/4	
2	Drawer sides	1/2 x 5 3/8 x 18 1/4		6	Drawer sides	1/2 x 5 3/8 x 18 1/4	
1	Drawer back	1/2 x 5 3/8 x 35 1/2		3	Drawer backs	1/2 x 5 3/8 x 33 1/2	
1	Drawer front	1 3/16 x 7 x 36 1/4		3	Drawer bottoms**	1/4 x 18 x 33	
2	Drawer sides	1/2 x 6 3/8 x 18 1/4		Hardware: 17 polished-brass pulls, 2 1/4-in. bore; 7 matching escutcheons; 7 mortise or half-mortise drawer locks, 1 1/4-in. selvage to key pin; available from Ball and Ball, 463 W. Lincoln Hwy., Exton, Pa. 19341. 1 1/2-in. and 2-in., #8 flat-head wood screws; 42, 1/2-in., #3 brass flat-head wood screws.			
1	Drawer back	1/2 x 6 3/8 x 35 1/2		All wood is white pine except where noted.			
1	Drawer front	1 3/16 x 7 1/2 x 36 1/4		s/s = shoulder-to-shoulder			
2	Drawer sides	1/2 x 7 1/8 x 18 1/4		* Hardwood			
1	Drawer back	1/2 x 7 1/8 x 35 1/2		** Plywood			
4	Drawer bottoms**	1/4 x 17 3/4 x 35					
14	Drawer center strips*	3/16 x 7/8 x 17 1/4	Base and upper chests				
8	Foot-attachment blocks	7/8 x 7/8 x 5 1/2					
	Corner glue blocks	As needed, see text					

strip along the back rails, flush with the molding ends, to complete the perimeter for each set of moldings. These strips fill the gap at the back of the chests and cover the ends of the backing boards.

To make the shaped bracket feet, you'll need two $\frac{7}{8} \times 4\frac{3}{4} \times 28$ boards. The boards are shaped to the ogee profile and then cross-cut into six 8½-in.-long sections. Two of these sections are mitered together to form each front foot. The remaining two shaped sections are each dovetailed at a right angle to a $\frac{7}{8} \times 4\frac{3}{4} \times 8\frac{1}{2}$ flat piece to form the rear feet. To make the concave shape, run the boards diagonally over the tablesaw blade, taking very light, repetitive cuts using the setup shown in figure 1 at right. Begin cutting with the blade exposed only about $\frac{1}{16}$ in. above the table and raise it about $\frac{1}{16}$ in. for each consecutive pass. Draw the desired profile on the end of one of the boards and as you approach the line, adjust the angle of the fence to get the cove cut that you're after. When the cove is complete on both pieces, use a jack plane to make the top curve. Sand the sawmarks from the cove and smooth the top curve before cutting the boards into the six 8½-in. lengths that make up the feet.

Now, take four of the pieces, and miter one end of each to make the front feet; cut the dovetails on the remaining two shaped pieces and the flat back pieces that go together to make the rear feet. After cutting the joints, bandsaw out the shapes and glue the pairs together, reinforcing the joints with stacks of corner blocks to avoid the cross-grain problems you'd have with one vertical grain glue block. The feet are screwed to the bottom runners and rails of the chest through two $\frac{7}{8} \times 7\frac{1}{8} \times 5\frac{1}{2}$ blocks glued to the top inside edge of each foot. After the feet are in place, nail a $\frac{1}{4}$ -in. plywood dust bottom to the bottom rails and runners. The base chest is now complete except for the drawers, which should be built all at once after both the top and bottom carcasses are complete.

Building the upper chest—The dimensions for the upper chest are derived from the frame formed by the base's top molding. Since it nestles into the lip of this molding, the top unit doesn't require any bottom molding of its own. The construction of the upper chest is identical to the base, except for the absence of the bottom molding, the addition of the top board and some framing for the three small upper drawers. This framing consists of two vertical stiles between the small drawers that are mortised and glued into the two top front rails, and four wide hardwood runners mortised into the rails behind the vertical stiles. The lower runners carry the drawers and have $\frac{1}{2}$ -in. by $\frac{7}{8}$ -in. strips glued to their surface to act as side guides. The two upper runners are called kickers and keep the drawers from tipping when pulled out.

After the upper chest is assembled, the remaining ogee shoe mold is mitered and screwed to its top runners and rails, and the $\frac{7}{8}$ -in. spacer is screwed along the back rail as with the other moldings. Again, just as on the base, nail a $\frac{1}{4}$ -in. plywood dust bottom to the upper chest. Cut this dust bottom undersize and center it on the chest's bottom so it will fit within the frame formed by the ogee molding around the top of the base.

Drawers and hardware—Build the drawers according to the detail on the plan. The sides are joined to the front with half-blind dovetails with a $\frac{3}{8}$ -in. setback on the top and sides. The back is joined to the sides with through dovetails. During assembly, the $\frac{1}{4}$ -in. bottom is inserted into grooves that are $\frac{3}{8}$ in. up from the bottom edge of the sides, front and back. If you use solid wood instead of plywood for the bottom, be sure to allow room in the grooves for cross-grain expansion.

After the drawers are glued up, saw and chisel a notch out of the bottom of each back to fit over the center guide. Then, as a track for the guides, each drawer gets two $\frac{5}{16}$ -in.-thick hardwood strips

Fig. 1: Cove cut for bracket feet

Begin with sawblade only $\frac{1}{16}$ in. above table and increase depth no more than $\frac{1}{16}$ in. with each pass.

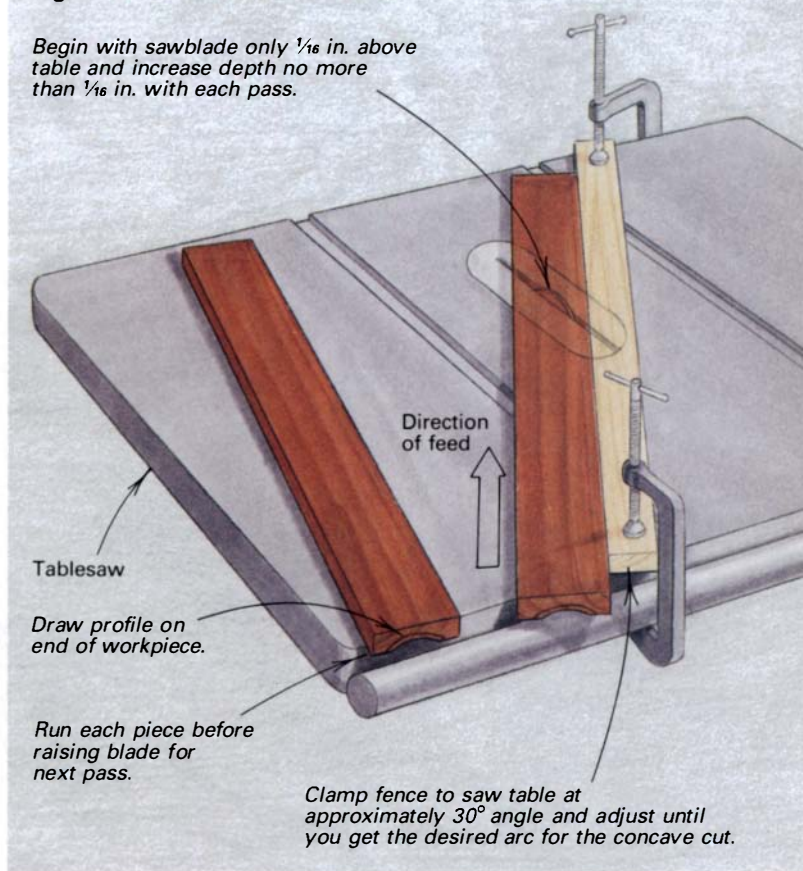

screwed to its bottom. To ensure accurate placement of these strips, insert one of the drawers into its opening until the front is against the face frame, and center the drawer side to side. Now, hold the guide strips alongside the center guide from below the drawer and drive three small brass screws down through the drawer bottom to hold each strip in place. Remove the drawer from the chest, unscrew the guide strips and put a spot of glue on the guide strip near each screw hole before replacing the screws.

When the guide strips are all in place on the upper chest drawers, you can screw the top board in place. Cut it to size to allow a 1¾-in. overhang on both sides and the front, and run the same ogee profile you used for the molding along the three overhanging edges. Fasten the top to the upper chest with eight 2-in.-long, #8 screws up through the top rails and runners—one near each corner and one 2½ in. each way from the center of the runners. Countersink and slot the screw holes in the runners to let the top expand front to back.

Brass pulls, escutcheons and drawer locks are available from Horton Brasses, Nooks Hill Road, Box 120F, Cromwell, Conn. 06416, or Ball and Ball, 463 W. Lincoln Highway, Exton, Pa. 19341. However, if you are so inclined, the backing plates can be easily bandsawn from sheet brass (available from a hobby supply store) using a fine-tooth metal-cutting blade running at your normal woodworking speed. Unless you also want to venture into casting brass, you can buy the posts and bails from Horton Brasses or Ball and Ball. □

Carlyle Lynch was a Broadway, Va., designer, cabinetmaker and retired teacher. He passed away shortly after writing this article (see his obituary on p. 114). His drawings have appeared regularly in FWW and are available from Garrett Wade, Lee Valley Tools and Woodcraft Supply.

Round-Bottom Planes

Making tools to fit your hands and needs

by Monroe Robinson

Making wooden planes is a good introduction to tool construction. There are only a few parts, and high-quality custom plane irons and chip breakers are available if you don't want to make your own.



Power tools are wonderfully efficient at roughing out furniture parts, but I think the ultimate in craftsmanship is integrating creativity with hand tools, away from the vibration, noise and dust of machines. When building furniture, I get a large part of the job done with labor-saving power equipment. But I turn to hand tools for final fitting and detailing because woodworking is an expression not only of skill, but also of the tools and methods used to create a piece.

One of my most satisfying hand tools is the plane, and although I value several commercially available metal models, my favorites are all-wooden ones that I've made. These planes work so well because they are customized specifically to fit a job's requirements, my hands and my way of working. And it just feels good using them. Making a wooden plane, like that shown in the photo above, is a good introduction to hand-tool construction, and the result is an efficient and enjoyable tool. And many of the same tuning techniques can be used to improve the performance of your metal planes as well.

Once you know the basics of plane construction, which are much the same for any wood specialty plane, you'll be able to make one to suit your particular needs. The construction procedure incorporates two midsection pieces that hold the plane iron and chip breaker by means of a wedge, and are sandwiched between two cheeks, as shown in the drawing on the facing page. A single block of wood is cut into pieces that, when assembled, form the plane body. A cheek is bandsawn from each side of the block of wood, and then the midsection is bandsawn into three pieces, forming the plane iron ramp and creating a chip clearance opening. The wedge can be cut from the waste piece left from bandsawing the front and rear midsections to shape. The body and the sole of the plane are shaped after assembly and then the plane is fine-tuned. Although some of these planes are made for a specific job, I always seem to find other uses for them later.

A round-bottom plane is a great first plane project because it's a very useful tool and most woodworkers don't already have one. It excels at shaping coopered doors, creating scalloped reliefs on door panels or smoothing curved parts after they've been bandsawn to shape. By using round-bottom planes, along with spokeshaves or a compass plane, and a scraper, I can shape curved surfaces smoothly enough to eliminate the need for sanding before finishing.

Plane irons and chip breakers—Because the iron will determine the dimensions of the plane body, the first step is to choose a chip breaker and iron. You can salvage irons from flea markets and antique shops, buy commercial replacement or custom-made irons, or forge your own. My favorites for small specialty planes are from an old set of molding plane irons, but for the round-bottom plane, I prefer irons from Hock Handmade Knives (16650 Mitchell Creek Drive, Fort Bragg, Cal. 95437), as shown above. These irons are pre-ground to specific radii and are available with a fitted breaker. For information on making your own plane irons, see *FWW* #55, pp. 63.

Selecting and machining the blank—Although I have used exotic hardwoods, such as cocobolo for the plane shown above, a growing concern for saving the rain forests of the world led me to question indiscriminate use of these woods. Domestic woods, such as beech, hard maple or ironwood, also make excellent planes. The blank should be 1 in. or 2 in. longer than the finished plane and 2½ in. to 3 in. high. The width is determined by the plane iron plus ⅛ in., and approximately ¼ in. for both cheeks and another ¼ in. for all machining. For a smaller plane, the cheeks may be as thin as ¼ in. On heavily used flat-bottom planes, I frequently add a sole of lignum vitae because of its natural oiliness and hardness. For the less frequently used round-bottom plane, a special, harder sole is not necessary if the plane is made of beech,

Round-bottom plane

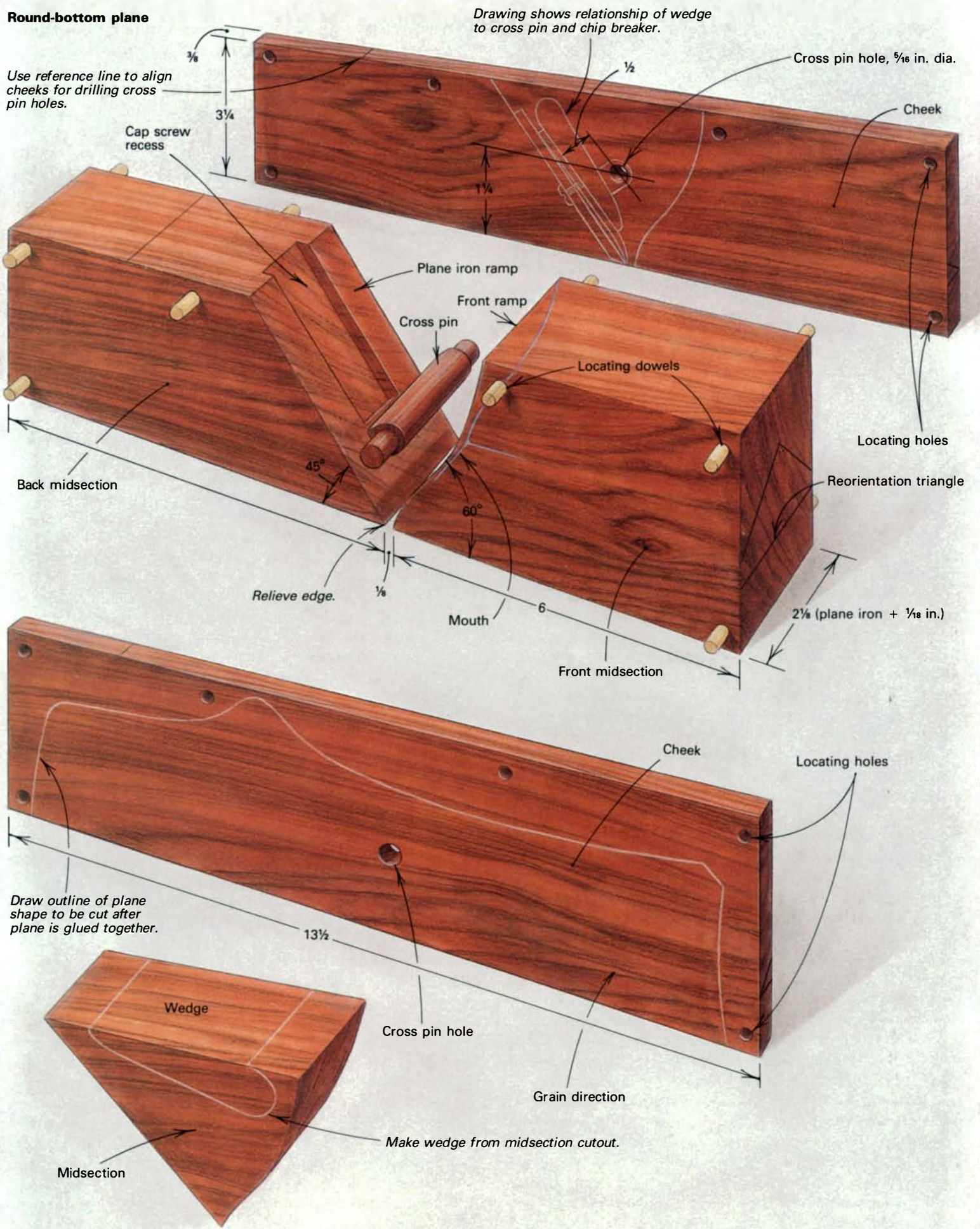



Align both cheeks using the reference line drawn across the top of the plane, clamp the cheeks together and drill a $\frac{1}{16}$ -in.-dia. hole on the drill press to ensure accurate alignment for the cross pin.

hard maple or other hard, close-grained wood. Lay out the plane so the growth rings are perpendicular to the sole and the grain runs down from front to back. Mark a reorientation triangle on the front of the block with one point up indicating the top, as shown in the drawing on the previous page, so all the pieces can be returned to their original positions after being bandsawn apart.

I mark off the cheeks, leaving the midsection $\frac{1}{8}$ in. wider than my plane iron and allowing an extra $\frac{1}{8}$ in. for jointing the sides of the midsection square and smooth. Then I bandsaw the $\frac{3}{16}$ -in. to $\frac{7}{16}$ -in. cheeks from either side of the midsection. Jointing the inside faces of the cheeks and both sides of the midsection ensures the sides of the plane will be perpendicular to the sole. After laying out the plane iron ramp at 45° and the front ramp opening at about 60° , so the shavings escape smoothly, the midsection is bandsawn into its front and back sections, as shown in the drawing. The cutout will later be used to make the wedge. While the curved front ramp can be smoothed with a scraper, a block plane is better for flattening and smoothing the plane iron ramp on the back midsection because the ramp must be both flat and square to the sides. Using a simple plywood template and a template collar guide mounted on my router, I cut the recessed slot, which can be seen in the photo on p. 80, to accommodate the cap screw, stopping about $\frac{3}{4}$ in. from the bottom. A router-mounted fence and stop blocks can also be used for making this recess or it can be chiseled or gouged out.

Before assembling the plane, I rough-shape the mouth of the front midsection by carving and filing it to match the radius of the plane iron. Rough-fitting the mouth to the iron at this time reduces the fine-tuning you need to do later through the opening of the completed plane. Check the fit by laying the back midsection on its side with the plane iron in place and slide the front midsection, also on its side, into position against the iron.

Now, using the reorientation triangle previously drawn, reassemble the parts leaving a $\frac{1}{8}$ -in. gap for the $\frac{3}{16}$ -in.-thick iron between the midsections to form the mouth of the plane. Leave a slightly smaller gap for a thinner iron. This spacing will further reduce the amount of work needed later in shaping the mouth to the iron. After aligning all the plane parts and clamping them securely together, drill several holes around the perimeter through the cheeks and into the midsections on both sides for locating dowels, as shown in the drawing. These dowels will be cut away when finish-shaping the plane, but until then, they allow you to precisely realign the parts after working on individual pieces as is necessary to fit the cross pin. Glue the dowels into the midsection and cut them flush with the cheeks so they won't interfere when gluing up the plane.

The cross pin has round tenons on its ends that fit into holes on each cheek, permitting it to pivot to the angle of the wedge. To

drill the holes, as shown in the photo at left, that serve as the mortises for the cross pin, first square a reference line anywhere across the top of the plane. Now remove one of the cheeks from the plane assembly and, with the iron and chip breaker in position, trace their outlines onto the remaining cheek, as shown in the drawing. Remove the second cheek from the midsections and mark the center for the cross-pin hole $1\frac{1}{4}$ in. from the bottom of the plane and $\frac{1}{2}$ in. from the top of the chip breaker, as shown in the drawing. Now align the cheeks using the reference line, temporarily clamp both cheeks together and make a $\frac{1}{16}$ -in.-dia. hole for the cross pin on a drill press to ensure straight, square alignment.

The cross pin, which can be made from either the same wood as the plane body or a contrasting wood, is a $\frac{1}{2}$ -in. square as long as the total width of the plane, including the cheeks; its tenons are as long as the thickness of the cheeks. To form the tenons, I use the miter gauge on the tablesaw with the blade raised $\frac{1}{2}$ in. I cut four shoulders on each end of the cross pin, and then round the tenons with a knife. The top edges of the midsection of the cross pin are rounded with a plane to ensure easy exiting of shavings. Check the fit of the cross pin with the plane assembled to make sure it will turn: A snug but not too-tight fit is best.

Assembling the plane—I dry-fit the cross pin in place, making sure that the tenons and locating dowels are flush with the cheeks, and then I glue and clamp the plane together using backup blocks to protect the cheeks. Once dried, I clean up any glue squeeze-out and make one light pass over the jointer to flatten the sole of the plane.

Next I draw the desired profile and bandsaw the plane from the blank. If this is your first plane, I suggest you leave it very rectangular until you use it for awhile, and then reshape it to fit your hand and your style of work. I don't like top-mounted handles because they force you to hold the plane high, throwing off the balance of the tool. I enjoy the texture and look of my planes as they come from the bandsaw; the tools I make are working tools. Rather than fuss with smoothing and embellishing, I leave the bandsaw marks and add only finger recesses gouged into the sides, as shown in the bottom photo on the facing page.

The wedge is bandsawn to shape from the midsection cutout and smoothed with a scraper to fit between the chip breaker and cross pin. Note the fit of the wedge in relation to the chip breaker (see the drawing). Test-fit the tapered wedge: If it is too flat, it will be hard to tap out; if the taper is too great, the slightest tap will dislodge it.

With the plane together, I now shape the sole and rework the mouth of the plane for a more precise fit to the iron, customizing the plane's mouth to the intended use of the plane. Although a very thin opening in front of the iron is essential for fine, controlled planing, a wider mouth opening of $\frac{1}{32}$ in. is better for hogging off waste or other rough planing. Fitting the mouth of the plane to the iron is the hardest and slowest part of the construction because you must carve away the front ramp to match the radius of the plane iron, while working through the small opening in the sole of the plane. I very lightly relieve the bottom edge of the 45° plane iron ramp to allow more working room through the mouth, as shown in the drawing. With the plane held upside down, I use a small knife and files to remove waste from the mouth at the front midsection until the cutting edge of the iron touches wood along its entire radius. Once the sole is shaped, this fit is further refined until the iron extends through the sole of the plane. If you are making or fine-tuning a plane to take thin shavings, it is crucial the mouth opening be very narrow, so be patient here.

I begin shaping the sole to match the radius of the iron by wedging the iron against the radius contour just carved in the front midsection. With the plane still upside down, I clamp it in a vise



Working through the small mouth opening, Robinson fine-tunes the plane to match the shape of the iron. Paper-thin shavings are possible only with a close fit between iron and mouth.



Shaping the mouth of the plane is the most tedious part of the construction, but the time and effort invested in attaining the fit shown here will be rewarded by top-notch performance.



Robinson prefers rectangular shapes for his planes and doesn't spend a lot of time refining the appearance of these working tools. Finger grips are gouged into the sides, corners are chamfered on the bandsaw and the bandsaw marks are left for a better grip.

and take full-length strokes with a flat-bottom plane, starting on the two outside edges and gradually working toward the middle where very little planing is needed. Remember, every plane stroke needs to be straight and extend the full length of the plane to maintain a radiused but flat sole. When I am $\frac{1}{32}$ in. or less from touching the radiused iron in the plane, I switch to a cabinet scraper to remove the planing ridges. I then place a strip of 220-grit sandpaper, grit up, on a flat surface. Rocking the plane from side to side while making long even strokes, I sand the bottom of the plane, being careful to keep it flat along its length. Now look carefully at the contour of the sole and the radius of the iron. If they don't match, you may need to lightly plane a little more and then resand. I then finish-sand with 320- and 400-grit paper on the flat surface.

Fine-tuning the plane—After sanding, the iron should come very close to, but not quite slide through, the mouth. Using a small file, I carefully file away the wood in front of the iron, as shown in the top, left photo, until the mouth and iron match perfectly, as shown in the top, right photo, and the iron just barely protrudes through the sole. Again, patience here will pay dividends in tool performance.

With the plane iron properly fitted to the mouth, the plane is ready for testing. If the plane doesn't cut a thin, even curl, first make sure that the plane iron is sharp. If it is, make sure that the chip breaker is adjusted to about $\frac{1}{32}$ in. from the cutting edge of the iron and that they fit tightly together. If you find chips or wood dust between the chip breaker and the iron, file and hone the chip breaker edge until the fit is perfect. I find a magnifying glass helpful to check this fit. With the iron and chip breaker in cutting position, I recheck the opening between the iron and mouth of the plane to see if there's a continuous bead of light along the radius and file as necessary. If the breaker is hitting the front midsection

of the plane, file away the high spots without widening the mouth.

Another potential problem area is that pressure from the iron can cause the sole to protrude directly behind the mouth. The pressure of the iron can cause this area to become a problem on older planes also. To check this, fit the iron and wedge in place, but not extended through the mouth, and then place a straightedge on the plane sole. If this area behind the mouth protrudes, the plane won't cut without a deep iron setting, which will produce a thick shaving and jam the mouth. I use a sharp scraper to remove a few shavings until this area is relieved. It is critical, however, that the sole directly in front of the iron contact the wood as you plane. If this area is relieved, the shaving will lift up and jam the throat or cause tearout ahead of the iron. Once I'm satisfied with the plane's performance, I seal the entire tool with a very thin varnish or oil, applying extra coats to all the endgrain.

Adjusting the iron in a wooden plane can be a little tricky, but it becomes quite easy with experience. I adjust my plane by holding it upright with two fingers under the sole, one touching each corner of the blade so I can feel the blade settings. You can also hold it upside down and sight along the bottom. Either way, the adjusting is done with light taps from a small hammer. A light tap on the back end of the plane body will back up the iron. Slightly harder taps will back up the iron and loosen the wedge. Light taps on the wedge will set the iron, while taps on the upper end or sides of the iron will adjust it deeper or to one side. With a little practice, you'll soon be setting up your plane for controlled cuts of only 0.001 in. or so. □

Monroe Robinson is a professional woodworker in Little River, Cal., and an instructor at the Anderson Ranch Art Center in Snowmass Village, Colo.

Tablesaw Safety Devices

A survey of blade guards, hold-downs and push sticks

by Charley Robinson

Many woodworkers don't use guards on their tablesaws, and they're quick to offer various reasons why: the guards have a reputation for getting in the way during some rabbeting, ripping and molding-head operations; they decrease visibility during a cut or setup; they create a safety hazard because stock hangs up on the guard; and they can damage the stock, reduce control and be a real hassle when you try to switch from one operation to another. And in many shops there can be some peer pressure against guards—use one and brace yourself for an afternoon of assorted ridicule.

Even though none of the commonly cited reasons can make up for the loss of a finger or hand in an accident that might have been prevented by a guard or other safety device, few woodworkers invest much time or thought in improving the guards that came with their saws or in developing their own safety devices. Fortunately, some manufacturers now offer devices designed to overcome most of the standard complaints about stock guards. In this article, I'll examine a couple of these alternatives, as well as several available hold-down devices, that can make the tablesaw a safer tool and give you more control over your work. First, let's consider how accidents happen.

Kickback's the key—Our 1983 survey of hand injuries (*FWW* #42, pp. 76-78) indicated the tablesaw caused more injuries than any other tool in the shop, accounting for 42% of the accidents reported by the more than 1,000 woodworkers who responded to our survey. The jointer was second at 18%. Most of the accidents occurred when operators tried to rip short, narrow or thin pieces of wood, although ripping knotty or warped lumber, plunge-cutting and using accessories such as molding, dado or planer attachments were also cited.

Tablesaw accidents are generally caused by one of two factors: the first is kickback, which frequently leads to the second—the operator hitting the rotating blade. Kickback generally occurs when the work binds against the back of the blade. The force lifts the wood until it hits the top of the blade and is hurled with great velocity toward the operator. This can happen when the kerf in the workpiece closes enough to grab the back of the blade, when the work is pinched between the back of the blade and a misaligned fence, or when the workpiece is moved away from the fence or twisted so it binds the sides of the blade. Kickback can also happen when cutoffs left on the table vibrate into the blade or are caught between the throat plate and the blade. Kickback happens so quickly that the operator has no time to react, and often a finger or hand is pulled into the blade, or the projectile hits the operator.

Safety devices can go a long way to protecting the operator. In the previously cited survey, reports of accidents to woodworkers using a blade guard, anti-kickback pawls and a splitter were practically non-existent. The American National Standards Institute (ANSI), composed of representatives of manufacturers and labor, established

guidelines for safe operation of woodworking equipment in shops under the jurisdiction of the federal Occupational Safety and Health Administration (OSHA). These guidelines state that the blade on a tablesaw must be covered on the top and sides down to the table. Also, ripping operations must be done with a splitter and anti-kickback pawls in place, but there is no requirement that these devices be attached to the guard itself. And, there are no standards regulating guard manufacturers, so they have freedom in designing shields that provide the visibility, easy adjustability, versatility and anti-kickback features that would most benefit woodworkers. With this in mind, let's take a look at some of the safety devices currently available.

Blade guards—*Biesemeyer Manufacturing's BladeGuard*, shown in the left photo on the facing page, is a metal-and-Plexiglas assembly suspended over the saw table on the end of a 50-in. arm. I found this arrangement provides good visibility and the guard is wide enough to work with the blade set at any angle for miter or compound miter cuts without interference. The guard will protect hands from side or top access to the blade, but a hand slid along the table will raise the guard out of the way just as easily as a piece of wood will, and there are no anti-kickback pawls or splitters attached to the guard.

I experienced no problems with stock being fed through the saw hanging up on the guard, until stock was more than 2 in. thick. When the blade is centered in the guard, there is potential for kickback of scraps in production crosscutting-type situations where small scraps accumulate on the table. Cut-offs trapped between the guard and blade are thrown toward the operator with potential for injury. Adjusting the guard close to the cut-off side of the blade helped keep scraps away from the blade and all but eliminated this problem.

The 2-in.-square tubular steel arm that's mounted at the end of an extension table to support the guard gives 50 in. of clear cutting to the right of the blade and unlimited cutting to the left of the blade or behind the saw. This system was designed to work with an extended table and installs in about 15 minutes; there is also a floor mount model available. An adjustable counterweight lets you balance the guard so there is very little added resistance when feeding stock. The *BladeGuard* is easily raised and locked out of the way, about 8¼ in. above the table, for making fence setups or using a sliding table. Because the guard is suspended above the table, it can be left in place for dado or rabbet cuts or most operations that usually require removing a stock guard. The overhead arm that supports the guard slides inside the support arm that is bolted to the table. Turning a crank on the support arm positions the movable arm over the blade. While this procedure is fairly slow, it does provide safe and accurate adjusting and you normally would not have to move the setup more than a couple of inches.

In addition, the guard also has an alarm system that can be

The large, clear Brett-Guard offers good visibility of the blade and the workpiece, and holes through the guard allow you to easily attach a fence for coving or other operations. The guard must be adjusted to stock thickness, however, and the inflexible mounting and large area covered can make it difficult to push the work past the blade.

The Biesemeyer BladeGuard, which is suspended over the table at the end of a 50-in. arm, allows operations, such as dadoing large panels with the guard in place, that are impossible with other guards. Although the unit is convenient and easy to use, a separate splitter and anti-kickback device are also needed.

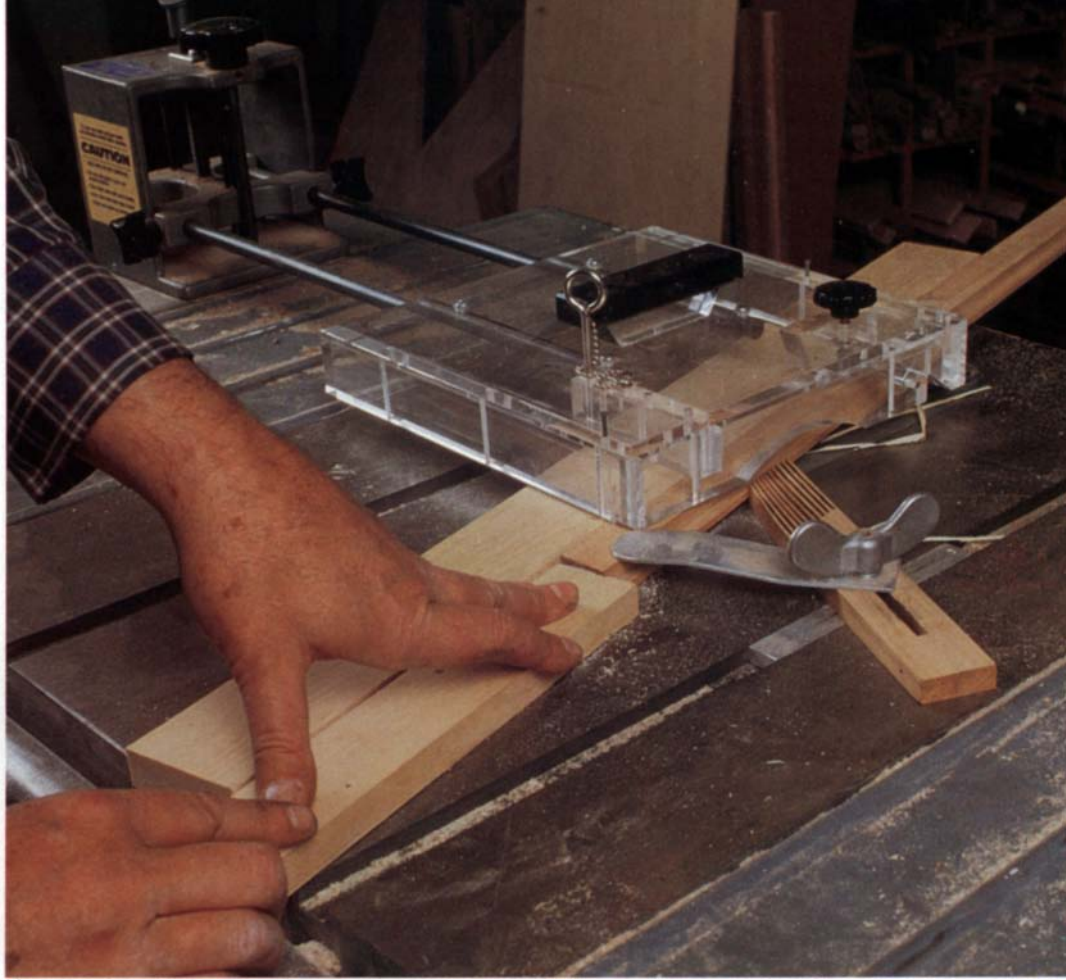

switched on or off with a key. A loud and obtrusive warning, equal in intensity to a smoke alarm, sounds the second the guard is locked into the raised position. This alarm system was primarily designed for high school shop situations so the shop monitor would be more aware of students' guard usage. Commercial shops may consider the alarm to be strong evidence of their commitment to safety when the OSHA inspector makes a visit, but I doubt it will be used at other times. One minor complaint is that with the guard down, the knob that releases it from the raised position is just about where I want my nose to be when I'm lining up my cutting mark with the blade.

At \$385, the *BladeGuard* may show up more in commercial production shops than the home market and that's where it will be most appreciated. This is the most convenient guard I've used: Once it's on the saw, it seems to do its job without needing readjustments and creates minimal interference with the work at hand. It is easily raised to a locked position, to adjust jigs or fences or to clear cut-off tables or other special operations, and then is just as easily returned to the working position. Although the lack of anti-kickback pawls and a splitter will require additional devices to meet OSHA requirements, the guard is so convenient that it will probably be used.

The *Brett-Guard*, manufactured by *HTC Products, Inc.*, is an 11-in. by 11-in. Plexiglas box that is suspended over the sawblade on steel rods attached to a control unit, as shown in the right photo above. The control unit is in turn secured by a locking rod and knob assembly to auxiliary plates bolted to the sides and back of the saw table. Although moving the guard to a new mounting plate is easily accomplished by unscrewing the locking knob, it did take an inordinate number of turns. Tim Hewitt, president of *HTC*, said that on newer models the thread length has been reduced by half and the knob will now lock down in about a turn and a half. The hardest part of installing the *Brett-Guard* is drilling holes in the saw table. One problem on saws like the Delta Contractor's model, to which I mounted it, is that the back mounting plate interferes with motor movement when the blade is tilted for bevel cuts. However, an

optional mount is available that provides clearance for the motor.

The large, clear box that serves as the guard provides the best blade and work visibility of any of the guards I used. However, for precise alignment of the rip fence, I still found it easier to set up the fence before positioning the guard. As with all the guards I tried, static electricity attracted dust particles to the plastic box, but that was more of a nuisance than a real problem. The adjustable anti-kickback plate of the *Brett-Guard* works only when the guard is mounted on the left side of the saw and I found this device tended to scratch the work when adjusted to a position that would prevent kickback. A crank on the control unit raises and lowers the guard; and loosening a couple of thumbscrews allows it to be moved toward or away from the control unit. It is necessary to manually readjust the guard each time you work with material of a different thickness. The manufacturer recommends that the guard be adjusted to rest lightly on top of the work and in this position, it helps hold down the stock being cut. If the work is too high to fit under the guard, adjust the guard to form a channel between it and the fence through which the work can be passed. Although this leaves the blade uncovered, it does offer more protection than no guard. I also found a potentially dangerous situation might occur when ripping long boards or cutting large panels. Without some means of support on the outfeed side of the saw, a long board can lever up the guard, possibly exposing or jamming the blade and damaging the guard.

A stop pin included with the guard is handy for repetitive cuts, and a series of holes in the guard can be used for mounting accessories, such as an angled fence when making cove cuts. In theory this has some interesting possibilities, but in practice I found there was too much play in the suspended guard to yield consistent results when coving a piece of stock. Clamping the fence to the saw table would eliminate the play, but then why bother screwing it to the guard if you have to clamp it anyway. There were a few situations when the guard interfered with the saw operation, such as when ripping sheet goods, or limited the capacity, such as when

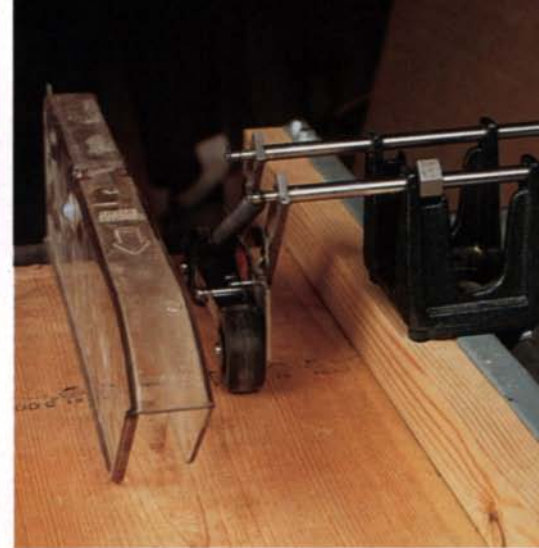
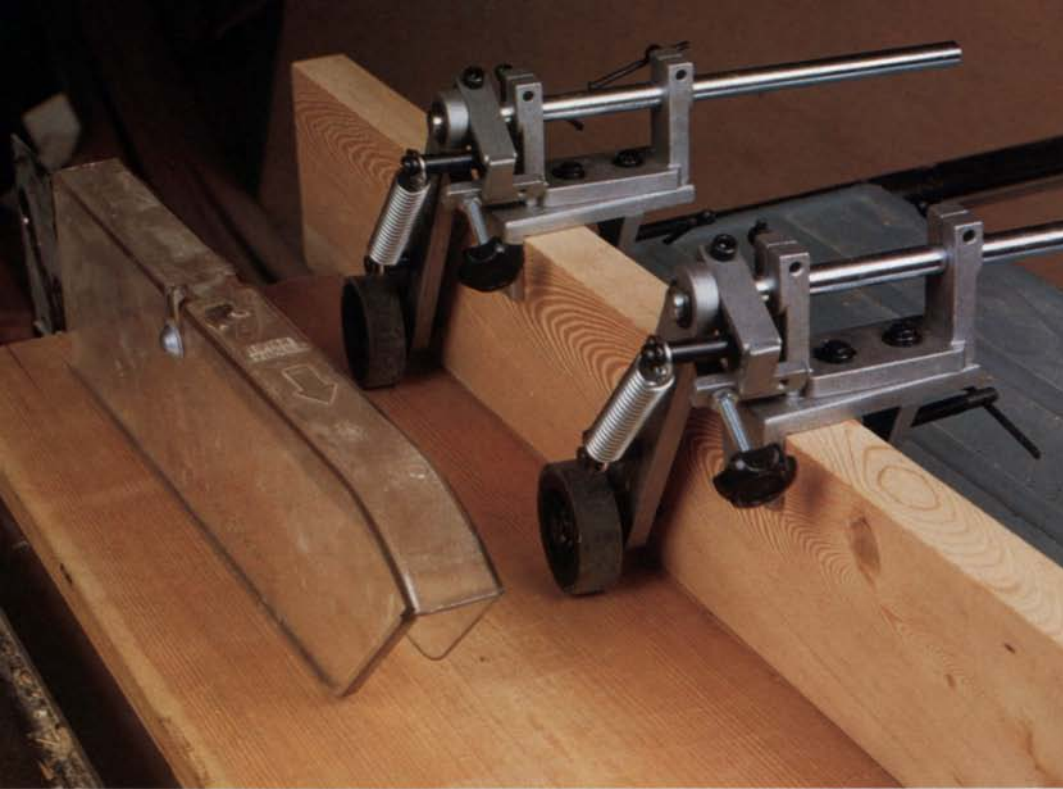

Above: Ripstrate's hold-down is the most compact of the group and required the fewest adjustments, although it did not hold boards against the fence as well as the others.

Left: The flexibility of Leichtung's Anti-Kickback Hold-Down Guide System and the superior grip of its soft rubber wheels give it an advantage over similar systems.

crosscutting. The *Brett-Guard* retails for \$214, but the manufacturer advises that for \$379 you can order a cantilevered system that mounts at the end of a 50-in. extended side table that solves these problems. Also, an overhead mounting system and a floor mounting system have been developed, but these are probably most suited for larger shops and industrial applications.

Hold-down devices—Most commercial hold-downs rely on a series of rollers to force stock snugly down on the saw table. This setup protects operators in two main ways: it allows them to feed stock through the saw without putting their hands near the blade and it reduces the likelihood of kickback because the stock cannot lift off the table enough to be thrown by the blade. Many hold-down devices also have additional anti-kickback features, which the manufacturers say allow operators to stop feeding stock in the middle of the cut, walk to the back of the saw and pull the work through. In all cases, make sure the motor pulley and belt guards are in place if you are going to be working behind the saw. Also, this technique can be dangerous and, at best, requires a little practice before you are able to produce perfect results. Many operators working on the back of the saw tend to pull the work away from the fence on the outfeed side, which in turn can wedge the stock between the blade and fence on the infeed side. Not only does this ruin the workpiece, it can cause kickback and possibly pull you into the blade. One problem I encountered with most of the hold-downs I tried is that they interfere with push sticks and with the normal function of the guards when trying to rip pieces narrower than 3 in. Sometimes the guards can be removed and the hold-down device positioned over the blade in its place. This does not protect the side of the blade, however, so be careful when using this setup. All of these devices should be used in conjunction with guards, safe practices and common sense, not in place of them.

The *Anti-Kickback Hold-Down Guide System*, shown in the left photo above, is available only from *Leichtung Work Shops* for \$49.99. It was the best of the hold-downs I tried, although it took about 30 minutes to assemble the pieces. Two spring-loaded hold-down arms equipped with rubber wheels are independently mounted to an auxiliary fence and can be adjusted to hold the work firmly to the table and to the fence. I like the adjustability of these units the most. The wheels can either move freely or be set to lock in either

direction. By adjusting the angle of the wheels to the fence up to 15°, the operator can fine-tune the amount of pull to the fence required by each job. Reversing the wheels on the arm allows you to rip very narrow stock with the wheels close to the fence, which contributes to one of the nicest features of this unit: When ripping very narrow stock, the wheels can be set parallel to the fence so they span the sawkerf. Pushing the stock through and past the blade from the left side causes the wheels to turn, acting like a power feed and driving the cut-off stock out the back side of the blade without a push stick. I was unable to duplicate this trick with any of the other hold-downs. Hold-down pressure is adjustable, as is the control arm for stock thickness. The anti-kickback feature also performed quite well. The soft rubber of the wheels was able to grip the workpiece firmly enough to prevent my pulling the board out from under the unit, although it did allow the board to back up about 3/4 in.—enough to prevent a kickback from jamming the blade and possibly burning out your saw motor. As icing on the cake, all of this performance comes without having to buy any optional accessories.

The *Ripstrate* from *Fisher Hill Products*, shown in the right photo above, is \$69 and consists of a pair of wheels mounted via spring-loaded arms to a cast-iron carriage. A built-in clamp on the carriage holds the auxiliary fence, as well as the unit itself, to your stock saw fence. Mounting the carriage at about a 5° angle helps direct any stock pushed under the wheels toward the fence. It took about 10 to 15 minutes to set up the first time, but then the auxiliary fence and hold-down could be removed or installed in just minutes. The *Ripstrate* is self-adjusting to the thickness of stock, and it requires fewer adjustments than any of the other devices. When ripping narrow stock, the small size of this unit left more room for push sticks than the other units.

I found the *Ripstrate* to work fairly well as a hold-down, but I was disappointed with its ability to pull and hold material to the fence, particularly when ripping large panels, a situation where hold-downs can be most helpful. Also, the hard rubber wheels didn't grip the workpiece as well as some of the other devices. Although I was unable to generate a kickback with any of these hold-downs, I could, without difficulty, pull the board back out of the *Ripstrate* in spite of the wheels locking up as they were designed to do. The manufacturer assured me that the *Ripstrate* will eliminate kickback under most circumstances, but in the rare in-

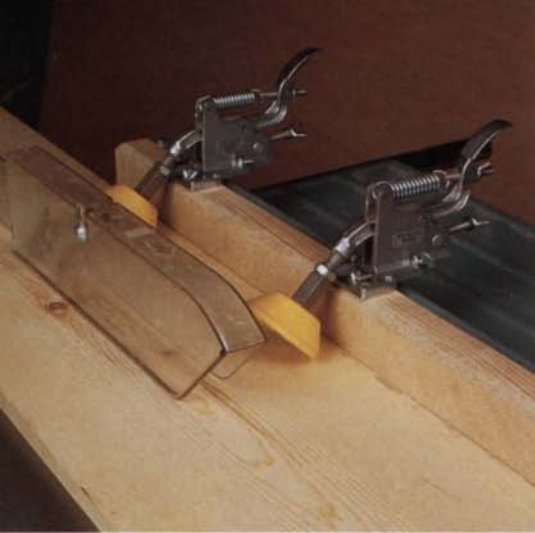

Above: Shophelper's yellow wheels hold the work to the fence, but gaining the adjustability of other systems requires a considerable investment in accessory tracks and wheels.

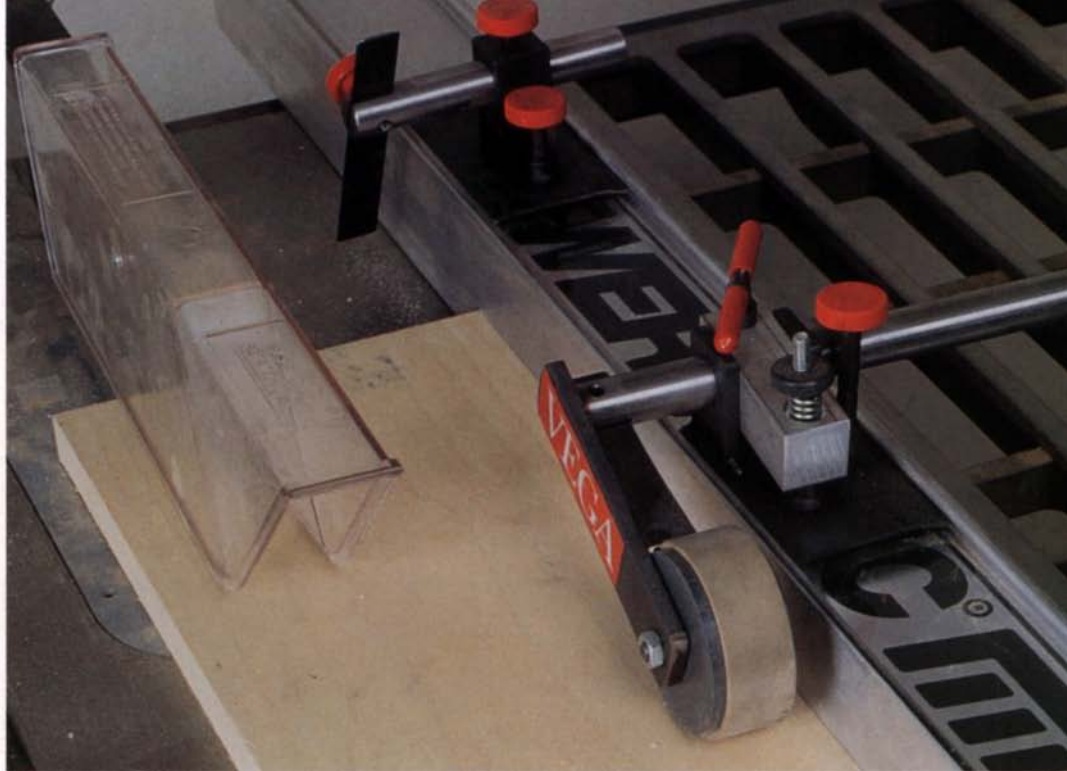

Right: The simply designed Vega Stock Feeder can be stored in place on top of Vega fence, but it would interfere with the company's push stick, which rides in the same track.

stance that it does occur, the wheels will stop the board.

At \$69.95, the *Shophelper*, by *Western Commercial Products*, is a pair of wheels individually mounted on levered axles, as shown in the left photo above. The wheel-and-axle housing slips into a mounting bracket that is screwed to an auxiliary fence. Rather than relying on a canted position to hold stock to the fence, the spring action of the axle arms directly pulls the work to the fence. This results in the workpiece being held more firmly against the fence than all of the canted wheel designs except the *Leichtung* system, which has an adjustable cant. Anti-kickback is provided by single-direction bearings in the wheels that limit stock feed to a right-to-left direction. While the bearings stopped the hard composition wheels, the wheels themselves were less effective at gripping the workpiece. Again, although I wasn't able to induce kickback, the board could be pulled back out of the *Shophelper*. Optional wheels (\$19.90) are available for reverse-direction feeding and an optional 24-in. mounting track (\$29.95) will allow front-to-back adjustability. The long mounting brackets that are standard with the *Shophelper* allow the wheels to be adjusted between $\frac{3}{8}$ in. and 5 in. of the fence.

Vega Enterprises' new entry in the wheeled hold-down market is the *Stock Feeder*, which mounts directly onto a *Vega* fence, as shown in the right photo above. The unit is \$59 and optional mounting rails, 12 in. long for \$7 and 24 in. long for \$12, are available for mounting the *Stock Feeder* to other fences. Immediately evident is that this device has a single wheel that rides on the stock in front of the blade combined with a spring steel hold-down finger in the back. The wheel, canted at 4° to pull stock toward the fence, can be adjusted to ride directly in front of the blade for stock up to 10 in. wide and is adjustable fore and aft along the length of the *Vega* fence or of the optional mounting rails. Both the front and rear hold-downs must be adjusted each time stock thickness changes, and setting the hold-down wheel as directed by the manufacturer greatly increases resistance to feeding stock through the saw. Although the wheel is easily adjustable to stock thickness, by itself it doesn't offer much resistance to kickback. The spring steel rear finger, held at 40° to the stock, provides the real means for preventing kickback, and its end is ground and polished to prevent scratching stock. By adjusting the hold-down to the extreme right, the unit can be stored out of the way on top of the fence. In this position, however, it will interfere with *Vega's Finger Saver*, a push stick that also rides on top of its fence.

Fingerboards—In general, fingerboards operate in much the same manner as hold-down devices. As shown in the bottom photo on the following page, they can be homemade or commercial, clamped to the saw table or clamped in the miter slot to hold work tight to the fence, or clamped to the fence to act as a hold-down. Their slanted, flexible fingers also help control kickback.

The *Universal Clamp*, shown in the top photo on the following page, is one of those devices that makes you wonder "Why didn't I think of that?". It's a simple fingerboard that mounts in the miter gauge slot of your table saw. When the large, comfortable wing nut on top is tightened, it clamps the fingerboard in position and expands a split aluminum bar in the miter gauge slot to lock the unit to the table. An aluminum finger that serves as a hold-down for $\frac{3}{4}$ -in. stock can be easily moved out of the way when it's not needed. Because the clamp mounts in the miter gauge slot, its capacity is limited, but it is so easy to use and effective that I want one; and at \$24.95 it's not worth the trouble to try to make something like this in your shop. The *Universal Clamp* is available from a number of mail order sup-

Sources of supply

Biesemeyer Manufacturing, 216 S. Alma School Road #3, Mesa, AZ 85210; (602) 835-9300.

Fisher Hill Products, Fisher Hill, Fitzwilliam, NH 03447; (603) 585-6883.

Garrett Wade Co. Inc., 161 Ave. of the Americas, New York, NY 10013; (800) 221-2942, (212) 807-1757.

HTC Products, Inc., 120 E. Hudson, Box 839, Royal Oak, MI 48067; (313) 399-6185.

Leichtung Work Shops, 4944 Commerce Parkway, Cleveland, OH 44128; (216) 831-6191.

The Original Wall-Marker Co., Box 436045, Louisville, KY 40243-6045; (502) 245-5930.

Shopsmith Inc., 3931 Image Drive, Dayton, OH 45414-2591; (800) 543-7586, (513) 898-6070.

Vega Enterprises, Inc., R.R. #3, Box 193, Decatur, IL 62526; (217) 963-2232.

Western Commercial Products, Box 1202, Tulare, CA 93275; (800) 344-7455, in CA (800) 828-8833.

Woodcraft, 210 Wood County Industrial Park, Parkersburg, WV 26102; (800) 225-1153.

Woodworker's Supply of New Mexico, 5604 Alameda Place N.E., Albuquerque, NM 87113; (800) 645-9292, (505) 821-0500.

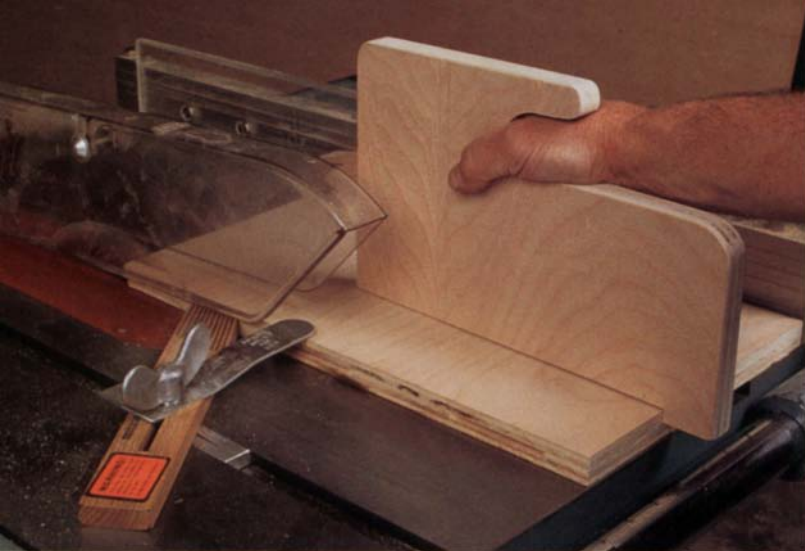

A twist of the large wing nut quickly fastens the Universal Clamp into the miter slot of the tablesaw, firmly holding work against the fence and the table while providing kickback protection. The push stick, designed by Todd Randall, of Cupertino, Cal., to provide both downward and forward control, books over your hand so any kickback will push your hand back, even if you lose your grip, to prevent contact with the blade. The easily adjustable shopmade hold-down, visible on the fence just in front of the push stick, offers convenient extra protection.

A variety of push sticks and hold-downs that can help save your fingers are clockwise from the left front of the saw table: the Universal Clamp, the Shopsmith Safety Kit, a shopmade featherboard, a shopmade push stick, the Saw-Aid (manufactured by The Original Wall-Marker Co.), two shopmade push sticks and a Biesemeyer push stick.



pliers, including Woodworker's Supply, Woodcraft and Garrett Wade (see sources of supply on previous page).

For \$23 the *Shopsmith Safety Kit*, shown in the bottom photo above, offers a variety of push sticks, blocks and a featherboard, all made of a plastic that is designed to powder if hit by a blade. The conventionally designed push stick has a nice heft and a molded handle that feels good. The fence straddler is a push stick designed specifically for narrow rip cuts on the Shopsmith tablesaw fence. It could, however, be adapted for use on other machines and offers more stability than a regular narrow push stick would for these cuts. A pair of push blocks that could be used for rip cuts over 4 in. wide are also included with the kit. The tilted handles keep your hands away from the fence while the substantial feel and the excellent grip of the soft rubber base make them a pleasure to use. I found them far superior to any other push blocks I've used, particularly for face-jointing boards. The final item in the package is a featherboard designed to mount in the miter gauge slot. Tightening the lock knobs not only fastens the featherboard to the miter bar, but also expands the miter bar in the miter gauge slot to hold it in place. This unit worked well on the Shopsmith, but tended to slide in the miter slot on my Delta Contractor's saw. I found a piece of 100-grit sandpaper glued to one edge tightened the fit in the slot and provided the grip needed to keep it in place. Although these tools were designed with the Shopsmith in mind, they are readily adaptable to other machines and they keep your hands out of harm's way.

Common sense—All the best safety equipment in the world can't replace common sense when working with hazardous equipment. You should always be aware of where your fingers are and where they might go if the board you are working on should suddenly disappear. Use a push stick, like those shown in the bottom photo above, to keep your fingers away from sawblades. My favorite design, which is shown in use in the top photo above, came from Todd Randall, a Cupertino, Cal., woodworker. Randall, who lost four fingers to a molding head cutter in a tablesaw, designed this push stick to be gripped between his thumb and the first knuckle of his index finger. Maintain good balance and don't overextend yourself or push too hard toward the blade. A smooth and well-waxed work surface and fence will reduce the effort needed. Take a second look at your procedures, even if you've been doing the same thing for a long time; there may be a safer way of doing it. Many operations can be done more safely on the bandsaw, especially with small pieces and knotty or warped boards. Heed the premonitions you have as you're about to perform a dangerous operation and ignore the less informed who would have you believe you're less of a woodworker for using guards. As Randall says, "If you like woodworking enough, take the steps necessary to protect your ability to do it." □

Charley Robinson is an Assistant Editor at FWW.

Woodworking Schools

Fine Woodworking frequently receives requests from woodworkers and would-be woodworkers looking for schools and instructional programs to help them improve their skills. Our last list was published in issue #39, back in March of 1983, so we felt it was time to update it. We sent surveys to several hundred schools throughout the United States and Canada and asked them to describe their programs. We tried to locate all the schools, but if you are a teacher or a student at a school we missed, please let us know. We'll update the survey as more information becomes available.

Some of the schools listed offer full-time and/or part-time classes and others offer evening or summer seminars. The list is intended as a guide to help you locate schools in various parts of the country. For more details on course offerings, application procedures and catalogs, write to the admissions offices. This list of woodworking schools was prepared by Whitney Potts.

ALABAMA

Wallace State Community College
Technical Division
801 Main St. N.W.
Hanceville, AL 35077

ALASKA

University of Alaska Southeast
7th & Madison
Ketchikan, AK 99901

ARIZONA

Arizona State University
College of Fine Arts
Tempe, AZ 85287-2102

Roberto-Venn School of Luthiery
4011 S. 16th St.
Phoenix, AZ 85040

University of Arizona
College of Arts & Sciences
Dept. of Art
Tucson, AZ 85721

Yavapai College
1100 E. Sheldon
Prescott, AZ 86301

ARKANSAS

Arkansas Art Center
Box 2137
Little Rock, AR 72203

Gallery B
11324 Arcade Dr.
Little Rock, AR 72212

University of Arkansas at Pine Bluff
Industrial Technology Dept.
UAPB Box 107
Pine Bluff, AR 71601

University of Central Arkansas
Industrial Education Dept.
Conway, AR 72032

CALIFORNIA

Bakersfield Community College
1801 Panorama Drive
Bakersfield, CA 93305

Baulines Craftsman's Guild
Schoonmaker Point
Sausalito, CA 94965

California College of Arts & Crafts
5212 Broadway
Oakland, CA 94618

California State University at Chico
Dept. of Art
Chico, CA 95929

California State University at Fresno
Dept. of Industrial Technology
Fresno, CA 93740-0009

California State University at Fullerton
Dept. of Art
Fullerton, CA 92634

California State University at Long Beach
School of Applied Arts & Sciences
Technology Education Dept.
1250 Bellflower Blvd.
Long Beach, CA 90840

California State University at Los Angeles
5151 State University Drive
Los Angeles, CA 90032

California State University at Northridge
Dept. of Art
18111 Nordhoff St.
Northridge, CA 91324

California State University at San Bernardino
Dept. of Art
5500 State University Parkway
San Bernardino, CA 92407

The Center for Wooden Arts
Box 714
Sausalito, CA 94966

College of the Redwoods
1211 Del Mar Drive
Ft. Bragg, CA 95437

The Day Studio
1504 Bryant St.
San Francisco, CA 94103

Ganahl Lumber Co.
Box 31
Anaheim, CA 92805-5993

Grew-Sheridan Studio
500 Treat Ave.
San Francisco, CA 94110

Laney College
Wood Technology
900 Fallon St.
Oakland, CA 94606

Palomar College
Dept. of Cabinet/Furniture
Technology
1140 Mission

San Marcos, CA 92069

San Francisco State University
School of Creative Arts
Dept. of Design & Industry
1600 Holloway Ave.
San Francisco, CA 94132

Sierra College
5000 Rocklin Road
Rocklin, CA 95677

COLORADO

Anderson Ranch Arts Center
Box 5598
Snowmass Village, CO 81615-5598

Metropolitan State College
Dept. of Technology & Technical
Communications
1006 11th St., Campus Box 90
Denver, CO 80204

R & D Framing School
227 Jefferson
Ft. Collins, CO 80524

School of Classical Woodcarving
1301 Wazee St.
Denver, CO 80204

University of Southern Colorado
College of Applied Science &
Engineering Technology
2200 Bonforte Blvd.
Pueblo, CO 81001-4901

Western State College
Dept. of Art & Industrial
Technology
Gunnison, CO 81231

CONNECTICUT

Brookfield Craft Center
286 Whisconier Road
Brookfield, CT 06804

DISTRICT OF COLUMBIA

Corcoran School of Art
17th & New York Avenue N.W.
Washington, DC 20006

FLORIDA

Brevard Community College
1519 Clearlake Road
Cocoa, FL 32922

Daytona Beach Community
College
Dept. of Technology
1200 Valusia Ave.
Daytona Beach, FL 32014

University of West Florida
Technical & Vocational Studies
Building 70
Pensacola, FL 32504

GEORGIA

Atlanta College of Art
Woodruff Arts Center
1280 Peachtree St. N.E.
Atlanta, GA 30309

Berry College
Industrial Technology, Box 237
Rome, GA 30149

Highland Hardware
1045 N. Highland Ave. N.E.
Atlanta, GA 30306

Kirby Studios
Box 1769
Cummings, GA 30130

HAWAII

University of Hawaii at Hilo
Hawaii Community College
Trade & Industry Division
Hilo, HI 96720-4091

IDAHO

Ricks College

Division of Engineering &
Technology
Technology Education &
Construction Management
Rexburg, ID 83460-1030

ILLINOIS

Chicago School of Violin Making
3446 N. Albany
Chicago, IL 60618

Chicago State University
95th at King Drive
Chicago, IL 60628

The Dovetail Joint
1332 Harlem Blvd.
Rockford, IL 61103

University of Illinois at Urbana
10 Henry Administration Building
506 S. Wright St.
Urbana, IL 61801

John Wood Community College
150 S. 48th St.
Quincy, IL 62301

INDIANA

Indiana University
Herron School of Art
1701 N. Pennsylvania St.
Indianapolis, IN 46202

IOWA

Des Moines Area Community
College
2006 S. Ankeny Blvd.
Ankeny, IA 50021

Iowa State University
158 College of Design
Ames, IA 50011

KANSAS

Bethel College
Dept. of Natural & Applied
Sciences
300 E. 27th St.
North Newton, KS 67117

Fort Hays State University
Industrial Education Dept.
600 Park St.
Hays, KS 67601-4099

Independence Community College
Registrar's Office, Box 708
Independence, KS 67301

Neosho County Community
College
1000 S. Allen
Chanute, KS 66720

Pittsburg State University
Industrial Arts & Technology Dept.
Pittsburg, KS 66762

Wichita Area Vocational/Technical
School
301 S. Grove
Wichita, KS 67211

KENTUCKY

Berea College
Industrial Arts Dept., Box 2313
Berea, KY 40404

Eastern Kentucky University
College of Applied Arts &
Technology
Industrial Education & Technology
Richmond, KY 40475-3115

Murray State University
Dept. of Industrial Education &
Technology
Murray, KY 42071

MAINE

Haystack Mountain School of
Crafts
Deer Isle, ME 04627-0087

The Landing Boatshop
Box 1490
Kennebunkport, ME 04046

Maine Maritime Museum
The Apprenticeshop
243 Washington St.
Bath, ME 04530

The Rockport Apprenticeshop
Box 539, Sea Street
Rockport, ME 04856

Southern Maine Vocational
Technical Institute
Fort Road
South Portland, ME 04106

University of Southern Maine
School of Applied Science
College Avenue
Gorham, ME 04038

The WoodenBoat School
Box 78
Brooklin, ME 04616

MARYLAND

Chesapeake College
Outreach Services, Box 8
Wye Mills, MD 21679

Garrett Community College
Continuing Education Division
Box 151, Mosser Road
McHenry, MD 21541

University of Maryland
College of Education
Dept. of Industrial, Technological
& Occupation Education
J.M. Patterson Building
College Park, MD 20742

University of Maryland
Eastern Shore, Box 1124
Princess Anne, MD 28153

MASSACHUSETTS

Boston Center for Adult Education
5 Commonwealth Ave.
Boston, MA 02116

Michael Coffey
1 Cottage St.
Easthampton, MA 01027

Heartwood
Johnson Hill Road
Washington, MA 01235

Horizons: N.E. Craft Program
374 Old Montague Road
Amherst, MA 01002

La Gitana Instruments
83 Riverside Ave.
Concord, MA 01742

North Bennett Street School
39 N. Bennett St.
Boston, MA 02113

Worcester Craft Center
25 Sagamore Road
Worcester, MA 01605

MICHIGAN

Andrews University
College of Technology
Berrien Springs, MI 49104

Delta College
Academic Affairs/Occupational
Programs
University Center, MI 48710

Northern Michigan University
304 Cohodas
Marquette, MI 49855

Western Michigan University
Engineering Technology Dept.
Kalamazoo, MI 49008

MINNESOTA

Dakota County Technical Institute
Intermediate District 917
1300 145th St. E.
Rosemount, MN 55068

Redwing Technical College
Pioneer Road at Highway 58
Redwing, MN 55066

St. Cloud State University
College of Science & Technology
115 Administrative Services
Building
St. Cloud, MN 56301

University of Minnesota
184 Darland Administration
Building
Duluth, MN 55812

Villa Maria Wood Workshops
Box 37051
Minneapolis, MN 55431

Wood Carving School
3056 Excelsior Blvd.
Minneapolis, MN 55416

MISSISSIPPI

Mississippi Valley State University
Dept. of Industrial Technology
Box 930
Itta Bena, MS 38941

MISSOURI

Missouri Southern State College
Newman & Duquesne Roads
Joplin, MO 64801

Northwest Missouri State
University
Dept. of Technology
Maryville, MO 64468

The School of the Ozarks
Dept. of Technology
Point Lookout, MO 65726

MONTANA

Northern Montana College
Enrollment Management
Box 7751
Havre, MT 59501

Western Montana College of the
University of Montana
710 S. Atlantic
Dillon, MT 59725

NEBRASKA

Peru State College
Division of Science & Technology
Peru, NE 68421

University of Nebraska
Vocational & Adult Education
44B Henzlik Hall
Lincoln, NE 68588-0359

NEVADA

Northern Nevada Community
College
901 Elm St.
Elko, NV 89801

NEW HAMPSHIRE

Keene State College
229 Main St.
Keene, NH 03431

University of New Hampshire
Paul Creative Arts Center
Durham, NH 03824

NEW JERSEY

The American Wood Carving
School
21 Pompton Plains Crossroad
Wayne, NJ 07470

Geoffrey Noden Furniture Design
11 Park Lane Ave.
Titusville, NJ 08560

Kean College of New Jersey
Dept. of Technology
Morris Avenue
Union, NJ 07083

Montclair State College
Dept. of Technology
Valley Road & Normal Avenue
Upper Montclair, NJ 07043

P & F Binington
7 Belmont Circle
Trenton, NJ 08618

The William Paterson College
Dept. of Art, 300 Pompton Road
Wayne, NJ 07470

Peters Valley
Route 615
Layton, NJ 07851

NEW MEXICO

New Mexico Highlands University
School of Professional Studies
Las Vegas, NM 87701

NEW YORK

City College of New York
Art Dept.
138th Street & Convent Avenue
New York, NY 10031

Craft Students' League
YWCA of the City of New York
610 Lexington Ave.
New York, NY 10022

Genoa
Box 250, Academy St.
Genoa, NY 13071

Hartwick College
Art Dept.
Oneonta, NY 13820

Jamestown Community College
Continuing Education
525 Falconer St.
Jamestown, NY 14701

The Lutherie
2449 W. Saugerties Road
Saugerties, NY 12477

Rochester Institute of Technology
College of Fine & Applied Arts
1 Lomb Drive, Box 9887
Rochester, NY 14623-0887

State University College at Buffalo
1300 Elmwood
Buffalo, NY 14222

State University of New York at
Morrisville
College of Agriculture &
Technology
Morrisville, NY 13408

State University of New York at
Purchase
Visual Arts Division
Purchase, NY 10577

Stripping Unlimited & Refinishing
12 All Points Drive
Holbrook, NY 11741

Thousand Islands Craft School &
Textile Museum, 314 John St.
Clayton, NY 13624

Thousand Islands Shipyard Museum
750 Mary St.
Clayton, NY 13624

NORTH CAROLINA

Appalachian State University
Industrial Education & Technology
Boone, NC 28608

Asheville-Buncombe Technical
Community College

340 Victoria Road
Asheville, NC 28801

The John C. Campbell Folk School
Brasstown, NC 28902

Cape Fear Community College
411 N. Front St.
Wilmington, NC 28401-3993

Catawba Valley Community
College
Route 3, Box 283
Hickory, NC 28602

Country Workshops
Route 3, Box 221
Marshall, NC 28753

East Carolina University
106 Whichard Building
Greenville, NC 27858-4353

Guilford Technical Community
College
Box 309
Jamestown, NC 27282

Haywood Community College
Freelander Drive
Clyde, NC 28721-9454

North Carolina State University
College of Forest Resources
Box 8005
Raleigh, NC 27695-8005

Penland School of Crafts
Penland Road
Penland, NC 28765

Pitt Community College
Drawer 7007
Greenville, NC 27835-7007

Rockingham Community College
Box 38
Wentworth, NC 27375

OHIO

Conover Workshops
18125 Madison Road
Parkman, OH 44080

Ohio Northern University
Dept. of Industrial Technology
Ada, OH 45810

Ohio University
School of Art, 69 W. Union St.
Athens, OH 45701

Gary Perkins
422 6th St.
Fremont, OH 43420

University of Cincinnati
OMI College of Applied Science
2220 Victory Parkway
Cincinnati, OH 45206

University of Rio Grande
Rio Grande, OH 45674

Wayne Center for the Arts
Box 382, 237 S. Walnut St.
Wooster, OH 44691

OKLAHOMA

Central State University
100 N. University Drive
Edmond, OK 73034

East Central Oklahoma State
University
Ada, OK 74820-6899

Northeastern State University
Tahlequah, OK 74464

Northwestern Oklahoma State
University
Oklahoma Boulevard
Alva, OK 73717

Panhandle State University
School of Education, Box 430
Goodwell, OK 73939

Southwestern Oklahoma State
University
Dept. of Industrial Education &
Technology
100 Campus Drive
Weatherford, OK 73096

OREGON

Oregon School of Arts & Crafts
8245 S.W. Barnes Road
Portland, OR 97225

PENNSYLVANIA

Bucks County Community College
Swamp Road
Newtown, PA 18940

James Cox
School of Woodworking
R.D. 2, Box 126
Honey Brook, PA 19344

Edinboro University of
Pennsylvania
Dept. of Art
Edinboro, PA 16444

Jeffrey Greene Design Studio
Ney Alley
New Hope, PA 18938

Indiana University of Pennsylvania
Dept. of Art, 115 Sprowls Hall
Indiana, PA 15705-1087

Johnson Technical Institute
3427 N. Main Ave.
Scranton, PA 18508

Kutztown State College
Kutztown, PA 19530

Maxwell & Kelly Furniture Co.
109 S. 24th St.
Philadelphia, PA 19103

Millersville University
Dept. of Industry & Technology
Millersville, PA 17551

Philadelphia School of
Chippendale Furnituremaking
7 N. Home Ave.
Topton, PA 19562

Shrawder Restorations, Inc.
Box 143C, Route 113
Phoenixville, PA 19460

The University of the Arts
Philadelphia College of Art &
Design, Performing Arts
Broad & Pine Streets
Philadelphia, PA 19102

Bob Zatzman Guitar Studio
6655 McCallum St.
Philadelphia, PA 19119

RHODE ISLAND

New England Institute of
Technology
2500 Post Road
Warwick, RI 02886-2251

Newport Area Vocational/Technical
Center
Wickham Road
Newport, RI 02840

Rhode Island School of Design
2 College St.
Providence, RI 02903

SOUTH CAROLINA

Piedmont Technical College
Industrial Technologies
Division
Drawer 1467
Greenwood, SC 29648

SOUTH DAKOTA

Freeman Academy
748 S. Main St., Box 1000
Freeman, SD 57029

TENNESSEE

Arrowmont School of Arts &
Crafts
Box 567
Gatlinburg, TN 37738
East Tennessee University
Dept. of Technology
Box 19060A
Johnson City, TN 37614

Hiwassee College
Dept. of Science & Mathematics
Route 3
Madisonville, TN 37354

The Hymiller School of
Fine Finishing
912 Lakeshire Drive
Fairfield Glade, TN 38555

Middle Tennessee State University
Industrial Studies Dept., Box 19
Murfreesboro, TN 37132

Tennessee Technological
University
Appalachian Center for Crafts
Box 347 A-1, Route 3
Smithville, TN 37166

Tennessee Technological
University
Dept. of Industrial Technology
Box 5106
Cookeville, TN 38501

TEXAS

Abilene Christian University
Industrial Technology Dept.
ACU Box 8107
Abilene, TX 79699

San Antonio College
Construction Technology
Southwest Center
800 Quintana Road
San Antonio, TX 78284

Sul Ross State University
Dept. of Industrial Technology
Alpine, TX 79832

Tarleton State University
College of Agriculture &
Technology
Box T489, TSU Station
Stephenville, TX 76402

Texas A & I University
Industrial Arts Division
Campus Box 203
Kingsville, TX 78363

Texas A & M University
Dept. of Industrial Vocational &
Technical Education
College Station, TX 77843-3256

University of North Texas
College of Arts & Sciences
Denton, TX 76203

VERMONT

Marlboro College
Marlboro, VT 05344

Russ Zimmerman
House of Woodturning
R.F.D. 3, Box 242
Putney, VT 05346

VIRGINIA

Norfolk School of Boatbuilding
Box 371
Norfolk, VA 23501

Virginia Commonwealth University
Department of Crafts
221 Shafer St. Playhouse

Room 205
Richmond, VA 23284-2519

WASHINGTON

The Center for Wooden Boats
1010 Valley St.
Seattle, WA 98109

Central Washington University
Randall Fine Arts Building
Art Dept.
Ellensburg, WA 98926

Cornish College of the Arts
710 E. Roy St.
Seattle, WA 98102

Northwest School of Wooden
Boatbuilding
251 Otto St.
Port Townsend, WA 98368

Seattle Central Community
College
Wood Construction Dept.
23rd Avenue S. & South Lane
Seattle, WA 98133

Spokane Community College
N. 2000 Greene St.
Spokane, WA 99207-5499

Steven Voorheis Studios
202 3rd Ave. S.
Seattle, WA 98104

Walla Walla College
Dept. of Industrial Technology
204 S. College Ave.
College Place, WA 99324

WEST VIRGINIA

Davis & Elkins College
Augusta Heritage Arts Workshop
Elkins, WV 26241-3996

Fairmont State College
Technology Dept., Locust Avenue
Fairmont, WV 26554

WISCONSIN

Chippewa Valley Technical
College
620 W. Clairemont Ave.
Eau Claire, WI 54701-1098

Fox Valley Technical College
Trades Division
1825 N. Bluemound Drive
Appleton, WI 54913-2277

Madison Area Technical College
Dept. of Trade & Industry
3550 Anderson St.
Madison, WI 53704-2599

Northeast Wisconsin Technical
Institute
Box 19042, 2740 W. Mason St.
Green Bay, WI 54307-9042

University of Wisconsin
Art Dept., 455 N. Park St.
Madison, WI 53706

University of Wisconsin at Stout
Center for Craftsmanship
Menominee, WI 54751

Western Wisconsin Technical
College
6th & Vine Streets
La Crosse, WI 54601

Wisconsin Indianhead Technical
College
1900 College Drive
Rice Lake, WI 54868

CANADA

Algonquin College of Applied Arts
& Technology
1385 Woodroffe Ave.
Nepean, Ont., Canada K2G 1V8

British Columbia Institute of
Technology
Student Services
3700 Willingdon Ave.
Burnaby, B.C., Canada V5G 3H2

Cambrian College
1400 Barrydowne Road
Sudbury, Ont., Canada P3A 3V8

Central Newfoundland Community
College
Grand Falls Campus, Box 413
Grand Falls, Newfoundland,
Canada A2A 2J8

Conestoga College of Applied Arts
& Technology
299 Doon Valley Drive
Kitchener, Ont., Canada N2G 4M4

Douglas College
Commerce & Business Dept.
Box 2503
New Westminster, B.C., Canada
V3L 5B2

Eastern Community College
Box 308
Clareville, Newfoundland, Canada
A0E 1J0

Fairview College
Trades Dept.
Box 3000
Fairview, Alta., Canada T0H 1L0

Fanshawe College
Dept. of Civil Technology
1460 Oxford St. E.
London, Ont., Canada N5W 5H1

Georgian College of Applied Arts
& Technology
School of Engineering Technology
1 Georgian Drive
Barrie, Ont., Canada L4M 3X9

Holland College
School of Visual Arts
50 Burns Ave.
Charlottetown, P.E.I., Canada
C1E 1H7

Northern Alberta Institute of
Technology
11762 106th St.
Edmonton, Alta., Canada T5G 2R1

Northern College of Applied Arts
& Technology
140 Government Road E.
Kirkland Lake, Ont., Canada
P2N 3L8

Northern Lights College
11401 8th St.
Dawson Creek, B.C., Canada
V1G 4G2

Red Deer College
Technical Training Division
Carpentry Dept., Box 5005
Red Deer, Alta., Canada T4N 5H5

Saskatchewan Institute of Applied
Science and Technology
Wascana Campus, Box 556
Regina, Sask., Canada S4P 3A3

Shrewsbury College of Arts &
Technology
Radbrook Centre, Radbrook Road
Shrewsbury, Canada SY3 9BL

Southern Alberta Institute of
Technology
1301 16th Ave. N.W.
Calgary, Alta., Canada T2M 0L4

St. Clair College of Applied Arts &
Technology
2000 Talbot Road W.
Windsor, Ont., Canada N9A 6S4

MLCS Ltd.



CONTROL THE SPEED OF YOUR ROUTER - ROUT AT THE SPEED THAT GIVES THE BEST RESULTS WITH THE WOOD AND BIT YOU ARE USING!

FEATURES:

- Speed Adjustable from Full Speed to 0 RPM
- Full Horsepower and Torque at All Speeds
- Go Back and Forth from Any Pre-Set Speed to Full Speed at the Flip of a Switch
- Works with All Routers 3 HP or Less
- 120V 15 Amp
- Gives Your Router a Feature Only Available on Routers Costing Hundreds of Dollars!

NOW ONLY \$39.95 Order Item #200

- Less Tear Out
- Feed at Comfortable Rate
- Better, Safer Results with Large Diameter Bits
- Less Wear on Bits
- Less Noise and Softer Starts at Lower Speeds
- Stops Burning

EASY TO USE - Simply plug in Speed Control and plug your router into the Speed Control - turn dial for best results. (Speed Control has a clip that can be worn on your belt or hung on wall or left loose.)

• Reduces speed electronically without reducing torque; electronic feed-back maintains speed by increasing voltage to motor as load increases.

CARBIDE TIPPED ROUTER BITS PROFESSIONAL PRODUCTION QUALITY GUARANTEED WHEN ORDERING ANY THREE OR MORE DEDUCT \$1.00 EACH. ALL PRICES ARE POSTAGE PAID

ITEM NO.	BEST CUT BEST PRICE	DESCRIPTION	ANGLE/DEPTH/RADIUS CIRCLE DIAMETER	LARGE DIA.	CUTTING LENGTH	SHANK SIZE	PRICE
#385		25 degree	25 degree	1 5/8"	1/2"	1/4"	\$25.00
#686		Raised Panel	25 degree	3 1/4"	1"	1/2"	\$25.00
#231		5/32" Roman Ogee	5/32" R	1 1/4"	1 3/8"	1/4"	\$17.00
#232		1/4" Roman Ogee	1/4" R	1 1/2"	3/4"	1/4"	\$18.00
#661		1/4" Roman Ogee	1/4" R	1 1/2"	3/4"	1/2"	\$21.00
#340		1/8" Cove	1/8" R	5/8"	1/2"	1/4"	\$12.00
#341		1/4" Cove	1/4" R	1"	1/2"	1/4"	\$13.00
#342		3/8" Cove	3/8" R	1 1/4"	9/16"	1/4"	\$14.00
#343		1/2" Cove	1/2" R	1 1/2"	5/8"	1/4"	\$15.00
#644		3/4" Cove	3/4" R	1 3/8"	3/4"	1/2"	\$28.00
#350		1/4" Round Over	1/4" R	3/4"	1/2"	1/4"	\$11.00
#351		3/16" Round Over	3/16" R	7/8"	1/2"	1/4"	\$11.00
#230		1/4" Round Over	1/4" R	1"	1/2"	1/4"	\$12.00
#354		3/8" Round Over	3/8" R	1 1/4"	5/8"	1/4"	\$15.50
#355		1/2" Round Over	1/2" R	1 1/2"	3/4"	1/4"	\$17.00
#656		3/4" Round Over	3/4" R	2"	7/8"	1/2"	\$21.00
#657		1" Round Over	1" R	2 1/2"	1"	1/2"	\$33.00
#460		1/4" Bull Nose	1/4" Dia. of Circle		1/2"	1/4"	\$14.00
#461		3/8" Bull Nose	3/8" Dia. of Circle		3/4"	1/4"	\$15.00
#462		1/2" Bull Nose	1/2" Dia. of Circle		3/4"	1/4"	\$16.00
#463		5/8" Bull Nose	5/8" Dia. of Circle		7/8"	1/4"	\$19.00
#464		3/4" Bull Nose	3/4" Dia. of Circle		1"	1/4"	\$21.00
#403		3/8" Dovetail	9 degree	3/8"	3/4"	1/4"	\$ 7.50
#405		1/2" Dovetail	14 degree	1/2"	1/2"	1/4"	\$ 8.50
#409		3/4" Dovetail	14 degree	3/4"	7/8"	1/2"	\$10.50
#709		3/4" Dovetail	14 degree	3/4"	7/8"	1/2"	\$10.50
#402		3/8" Dovetail	8 degree For	3/8"	1/2"	1/4"	\$12.00
#404		1/2" Dovetail	8 degree Leigh	1/2"	1 3/16"	1/4"	\$12.00
#708		1 1/4" Dovetail	8 degree Jigs	1 1/4"	1"	1/2"	\$14.00

ITEM NO.	BEST CUT BEST PRICE	DESCRIPTION	ANGLE/DEPTH/RADIUS CIRCLE DIAMETER	LARGE DIA.	CUTTING LENGTH	SHANK SIZE	PRICE
#370		3/8" Rabbeting	3/8" Deep	1 1/4"	1/2"	1/4"	\$14.00
#670		3/8" Rabbeting	3/8" Deep	1 1/4"	1/2"	1/2"	\$14.00
#366		1/2" Slot Cutter	3/8" Deep	1 1/4"	1/4"	1/4"	\$14.00
#368		1/4" Slot Cutter	3/8" Deep	1 1/4"	1/4"	1/4"	\$14.00
#415		1/4" Core Box	round nose	1/4"	1/4"	1/4"	\$10.00
#416		3/8" Core Box	round nose	3/8"	3/8"	1/4"	\$11.00
#417		1/2" Core Box	round nose	1/2"	1 1/2"	1/4"	\$14.00
#418		3/4" Core Box	round nose	3/4"	5/8"	1/4"	\$15.00
#719		1" Core Box	round nose	1"	3/4"	1/2"	\$18.00
#470		1/4" Straight	plunge cutting	1/4"	3/4"	1/4"	\$ 7.00
#471		3/16" Straight	plunge cutting	3/16"	1"	1/4"	\$ 7.00
#472		3/8" Straight	plunge cutting	3/8"	1"	1/4"	\$ 7.00
#474		1/2" Straight	plunge cutting	1/2"	1"	1/4"	\$ 7.00
#775		1/2" Straight	plunge cutting	1/2"	2"	1/2"	\$14.00
#476		3/16" Straight	plunge cutting	3/16"	1"	1/4"	\$ 7.00
#478		5/8" Straight	plunge cutting	5/8"	1"	1/4"	\$ 8.00
#479		3/4" Straight	plunge cutting	3/4"	1"	1/4"	\$10.00
#781		1" Straight	plunge cutting	1"	1 1/2"	1/2"	\$12.00
#545		Tongue & Groove	Straight	1 5/8"	1"	1/4"	\$29.00
#845		Tongue & Groove	Straight	1 5/8"	1"	1/2"	\$29.00
#546		Tongue & Groove	Wedge	1 3/16"	1"	1/4"	\$29.00
#846		Tongue & Groove	Wedge	1 5/8"	1"	1/2"	\$29.00
#859		Multiform Moulding	Unlimited Patterns	2 1/4"	2"	1/2"	\$50.00
#601		1/8" Spiral Cutter		1/8"	1/2"	1/4"	\$ 9.00
#602		3/16" Spiral Cutter		3/16"	5/8"	1/4"	\$12.00
#603		1/4" Spiral Cutter		1/4"	3/4"	1/4"	\$12.00
#903		1/4" Spiral Cutter		1/4"	3/4"	1/2"	\$12.00
#904		3/8" Spiral Cutter		3/8"	1"	1/4"	\$24.00
#905		1/2" Spiral Cutter		1/2"	1 1/2"	1/2"	\$29.00

New 24-page catalogue now available, featuring hundreds of bits.

MAKE BEAUTIFUL RAISED PANEL DOORS . . . WITH YOUR 1/4" ROUTER!

Professional production quality bit makes it quick and easy to produce matching rails and stiles — the panel raising bit with ball bearing guide makes the raised panel perfect every time.

RAIL & STILE SHAPER CUTTER
Item #150 - \$49.95



SALE PRICE **\$69.95** Regular value Over \$150.00 FOR COMPLETE SET

ORDER ITEM # 554 for 1/4" Shank Set (Includes all bits shown below)

REVERSIBLE COMBINATION RAIL and STILE BIT

(For making matching rails and stiles in raised panel doors, etc.) Works with stock from 1 1/16" to 7/8" thick

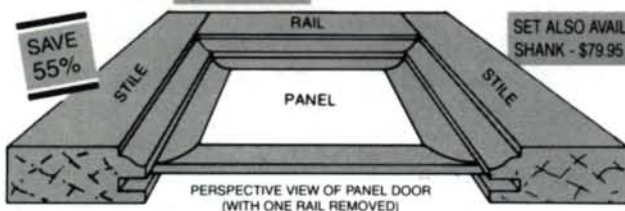

PERSPECTIVE VIEW OF PANEL DOOR (WITH ONE RAIL REMOVED)

SET ALSO AVAILABLE IN 3/8" SHANK - \$79.95 - Item #852

RAISED PANEL BIT SUPPLIED WITH BALL BEARING

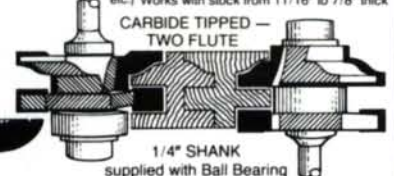
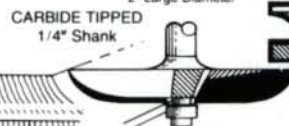

To order by Master Charge or Visa Call Toll Free, 7 Day - 24 Hour Order Service

1-800-533-9298 or send check to: **MLCS Ltd., P.O. Box 4053FH, Rydal, PA 19046**

TotalShop

**NEW! 24 pg.
Color Catalog
Absolutely Free**



FREE

Full of top quality
woodworking machines,
tools and accessories

1-800-845-9356

(In S.C. Call 288-4174)

Call Today!

Or Write Dept 14

P.O. Box 25429, Greenville, SC 29616

READER SERVICE NO. 65

SHAKER FURNITURE

An exciting collection of Shaker dining chairs, tables beds and other furniture available in Kits or completely finished. All exemplify the simplicity and versatile beauty of Shaker design. Pegs, Peg-board, shaker baskets, oval boxes and dolls.

New 48 page color catalog and 12 tape samples \$1.00. Large selection of replacement chair tape.

SHAKER WORKSHOPS

Box 1028-FW30, Concord, MA 01742



READER SERVICE NO. 159

VIDEO

Introduction to Japanese Woodworking

Traditional Hand Tools and
Sharpening Techniques
with Jay Van Arsdale Author of *Shoji*

VHS Color 70 mins. \$29.95 + \$3.00 (S & H)
AK & HI \$6.00

\$3 Full line Japanese Tools Catalog

HIDA JAPANESE TOOL, INC.

1333 San Pablo Ave. Tel (415) 524-3700
Berkeley, CA 94702 Fax (415) 524-3423

READER SERVICE NO. 303

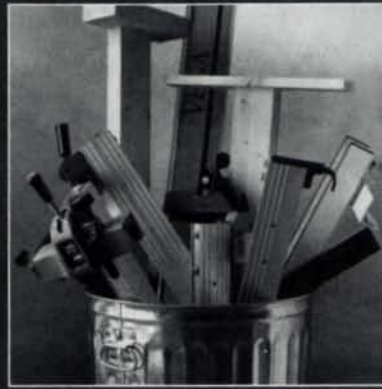

**BRING US YOUR
TIRED, YOUR POOR,
YOUR USELESS.**



We'll take it. Your old fence. In trade for the ultimate saw guide. The Delta Unifence® Saw Guide. And depending on which Unifence you buy (30", 52" and 96" capacity models), we'll give you \$25, \$45 or \$75 for your old clunker.

The Unifence is unmatched for accuracy, versatility and performance. Its exclusive dual English/metric scale makes set-ups to 1/64" (5mm) quick and easy.

Its unique fence body slides back and forth across the cutting area and locks in place. So you can make fast repetitive cut-offs, do precision ripping or cut large panels, including laminated stock.

The Unifence will work with just about any 10" table saw you own. Big difference is, it will work better. Which means, so will you.

Call toll free for the name of your participating Delta Distributor. Delta International Machinery Corp., 800/438-2486.

Offer good only on purchases in the continental U.S., Alaska and Hawaii from January 1 thru June 30, 1990.

Shown with accessory table and shelf boards.

**Building
On Tradition**
DELTA
A Pentair Company

READER SERVICE NO. 23

GLASS 3 MIRROR CRAFT **HEAVY GLASS TABLE TOPS**
 1/4"-3/8"-1/2"-3/4"-1" THICK GLASS
 "USING GLASS MAKES SENSE!"

Using Us Makes BETTER SENSE!

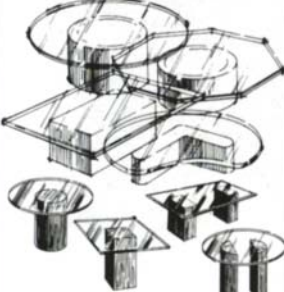

- Low Factory To You Pricing
- Low Transportation Costs
- Prompt, Courteous Service
- Toll Free Order Department
- Two Factories To Serve You Better In Michigan & Georgia
- We Guarantee Quality & Satisfaction

NATIONAL TOLL FREE NUMBERS

NORTHERN PLANT 1-800-528-5544
 MICHIGAN 1-800-627-7238

SOUTHERN PLANT 1-800-999-1192
 ATLANTA 1-404-881-0892

For FREE IDEA BROCHURE Write:
 Glass & Mirror Craft Industries, Inc.
 2111 HAGGERTY ROAD • P.O. BOX 516
 WALLED LAKE, MICHIGAN 48088

MANY EXCLUSIVE EDGWORKS!

- DOUBLE PENCIL
- CONCAVE BEVEL
- CHAMFER AT 45°
- FLAT POLISHED
- D.G. EDGE
- 1" BEVEL
- QUARTER BULL NOSE
- PENCIL POLISHED
- D.G. BEVEL
- TRIPLE BEVEL
- DOUBLE BEVEL

READER SERVICE NO. 32

JET TABLE SAW + BIESEMEYER \$1299



CTAS-10 3hp, Sgl Ph + Biesemeyer # 50 \$1299
 CTAS-10-1 3hp. Sgl Ph + regular fence 1249
 JTS-10 10" Tablesaw 419
 JWS-18 Woodworking Shaper 349
 JWS-34-1 Woodworking Shaper 895
 WSS-3 Woodworking Shaper 1349
 JJ-4 4" Jointer 229
 JJ-8 8" Jointer 895
DC-1182 Dust Collector 385
 DC-1883 Dust Collector 595
 JWP-12 12" Woodworking Planer 399
 DSS-15 15" Scroll Saw 119
 DBS-10 10" bandsaw 138
JBS-14MW 14" Bandsaw 339
 JBS-18 18" Bandsaw 725
 BDS-499 Drum Sander 595
 JSG-96 6" x 48" / 9" Belt Disc Sander 249
 JSG-6 6" x 48" / 12" Belt Disc Sander 449

Call for quotes on other JET products!!!
 Free freight on JE T orders over \$2359
 Quantities limited at above prices. Order Now.
 Orders shipped from Santa Rosa, CA, Smyrna, TN.
 Tacoma, WA.
 Prices Subject to Change Without Notice

SANTA ROSA TOOL & SUPPLY, INC.

READER SERVICE NO. 91

JJ6+ FREE FREIGHT \$349



Jet's 6" jointer has 2-way tilting fence adjustment with automatic stops at 45° right and left, 3/4 HP motor & high speed steel knives. Take advantage of this great special offer of **\$349** and **FREIGHT PREPAID.**

DC610+ FREE FREIGHT \$249



The DC-610 dust collector has a powerful 1 HP motor, attachment for 1 hose connection & wheel castors for portability. This is a great buy at only **\$249** and **FREIGHT PREPAID.**

MPF-3-1 Three Wheel Power Feeder **\$470**
 JPF-3-1 Three Wheel Power Feeder **760**
JWP-15H 15" Woodworking Planer 939
 JWP-20H 20" Woodworking Planer **1499**
 JWB-13P 13" x 60" Widebelt Sander **4850**
 JWB-25P 25" x 60" Widebelt Sander **6795**
 JWB-37P 37" x 60" Widebelt Sander **9995**

Nationwide service, \$2,000,000 parts inventory and the most reliable warranty in the business. Jet is unquestionably the best value in woodworking.
 Ad Expires 4/30/90 - Copyright 1990

MASTERCARD - Our 25th Year - DISCOVER
 VISA CA residents add sales tax AMEX
(800) 346-0387 (800) 345-8665 in Calif.
FAX (707) 545-3705
 1651 Piner Road, Santa Rosa, CA 95403

BARTLEY GEL FINISHES

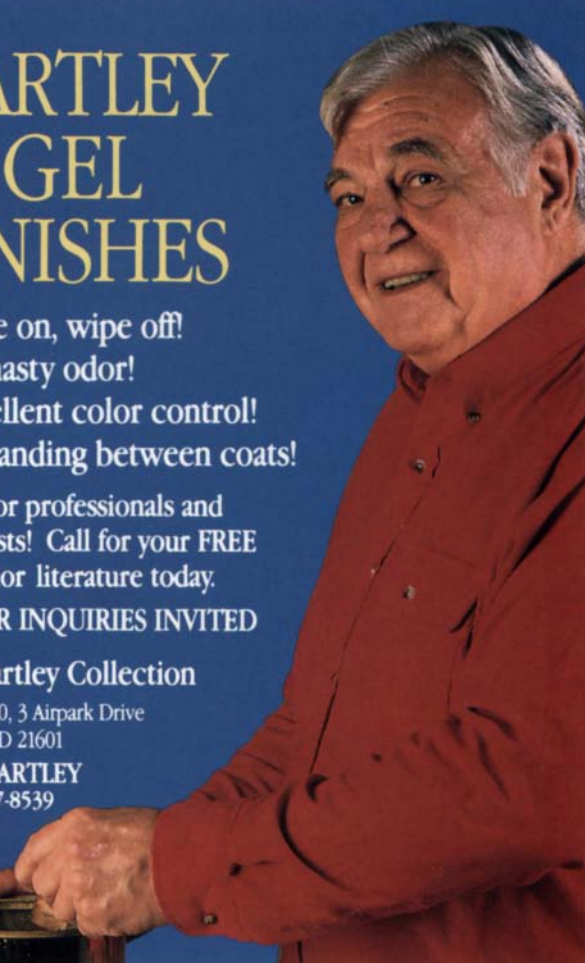

- Wipe on, wipe off!
- No nasty odor!
- Excellent color control!
- No sanding between coats!

Great for professionals and hobbyists! Call for your FREE full color literature today.
DEALER INQUIRIES INVITED

The Bartley Collection
 Dept. 4800, 3 Airpark Drive
 Easton, MD 21601
 1-800-BARTLEY
 1-800-227-8539

READER SERVICE NO. 9

STEVE WALL LUMBER CO.
 Quality Hardwoods and Woodworking Machinery For
 The Craftsmen and Educational Institutions

		UPS Specials
Ash	4/4 Select 1.90	\$53.00
Basswood	4/4 Select 1.30	\$43.00
Birch	4/4 Select 1.60	\$49.00
Butternut	4/4 Select 1.60	\$49.00
Cherry	4/4 Select 2.25	\$60.00
Hickory	4/4 Select 1.20	\$41.00
Mahogany (Genuine)	4/4 Select 2.50	\$67.00
Maple (Hard)	4/4 Select 1.45	\$46.00
Maple (Soft)	4/4 1C+Btr. .90	\$37.00
Pecan	4/4 Select 1.20	\$41.00
Poplar	4/4 Select 1.10	\$37.00
White & Red Oak	4/4 Select 1.80	\$55.00
Walnut	4/4 Select 2.35	\$62.00
Cedar (Aromatic Red)	4/4 1C+Btr. 1.25	\$40.00
White Pine	4/4 F.G. .90	\$35.00

Above prices are for 100' quantities of kilndried rough lumber sold by the Bd. Ft. FOB Mayodan, NC.
 Call for quantity discounts. Other sizes and grades available.

Above prices are 20 bd. ft. bundles of clear kilndried lumber 3"-10" wide • 3'-7" long (Random widths & lengths) Surfaced 2 sides or rough. Delivered UPS prepaid in the Continental U.S.

Send \$1.00 For Lumber and Machinery Catalog

Call For Best Prices On
DELTA MiniMax

STEVE H. WALL LUMBER CO.
 BOX 287 • MAYODAN, N.C. 27027
 919-427-0637 • 1-800-633-4062 • FAX 919-427-7588

READER SERVICE NO. 161



SALE

step up to

Makita
Power Tools

TOLL FREE 1-800-247-7178



Cordless Driver-Drill
2-Speed, Variable Speed,
Reversible
Model 6093DW
Sale Price — \$125.00

Portable 12" Planer
Model 2012
Sale Price — \$497.00

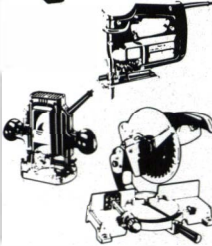

Electronic Jig Saw
Model 4302C
Sale Price — \$154.00

Plunge Router
1 1/4 h.p.
Model 3620
Sale Price — \$107.00

10" Miter Saw
Model LS1020
Sale Price — \$235.00

CALL TOLL FREE FOR OUR LOW PRICES ON
OTHER MAKITA TOOLS. In Wisconsin Call
608-244-4777.

5% Sales Tax for Wisconsin Residents.
HOURS: 8:00-4:30 Monday-Friday.
VISA • MasterCard • Money Order • Check

FREE FREIGHT
On All Tools



IN CONTINENTAL U.S.A.

P.O. BOX 7668

PRICES SUBJECT TO 1801 EAST WASHINGTON AVE.
CHANGE WITHOUT NOTICE MADISON, WI 53707

READER SERVICE NO. 72

Wood-Mizer®

World's
Largest
Manufacturer
Of Portable
Sawmills



OWN YOUR OWN SAWMILL
Four Models To Choose From
BUY DIRECT

1 800 553 0219

FREE In Indiana call: (317) 271-1542
44-page catalog or use
your MasterCard or VISA
to order our 50-minute
demonstration video—\$10.00

Wood-Mizer Products, Inc. • Dept. Z38
8180 W. 10th St., Indianapolis, IN 46214-2430

READER SERVICE NO. 42

HARTWOOD, LTD.

We stock the best available **Appalachian** and
Exotic hardwoods, veneers and plywood.

Exceptional widths and
thicknesses in stock.

Turning and carving
blocks.

Call or write for our free
price list and newsletter.

Let us introduce you to one of the largest lumber
selections anywhere.

P.O. Box 323, Dept. 1B, East Golden Lane
New Oxford, PA 17350 FAX: (717) 624-4365
Phone: (717) 624-4323 or (717) 334-9301



READER SERVICE NO. 34

\$2 Brings you our latest
Tool Catalog plus the
next 2 issues of *Wood News*



Our **TOOL CATALOG** features
over 2500 useful woodworking
tools, books and supplies.

WOOD NEWS is our popular
twice-yearly 48-page magazine
chock full of helpful articles on
getting the most out of your
woodworking tools.

**SUBSCRIBE
TODAY!**
Send \$2 to:

highland hardware
1045 N. Highland Ave, Dept F80
Atlanta, Georgia 30306

READER SERVICE NO. 202

Shape a new career.

If you are looking for
a career that rewards
creativity and tradi-
tional skills, investigate
The School for Profes-
sional Crafts. We offer a two year certi-
ficate program in Woodworking taught by
nationally recognized professionals. Enroll-
ment is strictly limited. For more informa-
tion on woodworking or our other pro-
grams call or write for our Professional
Crafts catalog.



**Worcester
Center
for Crafts** 25 Sagamore Road
Worcester, MA 01605
508/753-8183

READER SERVICE NO. 90



DOES IT AGAIN!

**2 H.P. DUST
COLLECTORS
MODEL G1029**



**SUPER LOW
PRICE \$295⁰⁰**

F.O.B. Bellingham, WA or Williamsport, PA

Clean up
on the job!
Hoses and fittings
available

**6" x 47" HEAVY
DUTY JOINTER
MODEL G1182**



REG. \$375⁰⁰
SALE PRICE \$345⁰⁰
F.O.B. Bellingham, WA or Williamsport, PA



**MOBILE BASE G1744
ONLY \$89⁹⁵**

**THE INCREDIBLE
"SHOPHELPER"
ANTI-KICK DEVICE**

ONLY \$49⁹⁵

MODEL G1630

"YELLOW" SHOPHELPER

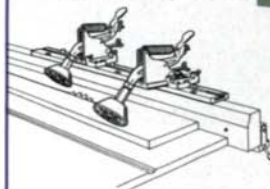

An excellent anti-kickback device
that keeps work firmly up against
the fence. (track optional)

Also Available:
**MODEL G1766
"ORANGE" SHOPHELPER
FOR RADIAL-ARM SAWS**
**MODEL G1578
"GREEN" SHOPHELPER
FOR SHAPERS**

**10" HEAVY DUTY
TABLESAW
MODEL G1022**

REG. \$365⁰⁰

SALE PRICE \$355⁰⁰
F.O.B. Bellingham, WA or Williamsport, PA



**MOBILE BASE G1739
ONLY \$89⁹⁵**

**INCR A JIG
MODEL G1768**



ONLY \$28⁵⁰

**INCR A JIG
HANDBOOK &
TEMPLATES**



MODEL G1836

100 Illustrated pages and 17
templates with hundreds of
possibilities.

ONLY \$17⁹⁵

ASK FOR OUR FREE 1990 CATALOG TODAY!

West of the Mississippi orders

1-800-541-5537
Service — 206-647-0801

East of the Mississippi orders

1-800-523-4777
Service — 717-326-3806

90-104

READER SERVICE NO. 74

BOSCH
Power Tools

only
\$238.00

**VAR. SPEED
PLUNGE ROUTER**

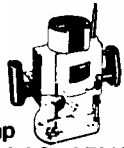

3 1/2 hp
Model 1611EVS

30% off all Bosch Router Bits

SAWS

1582VS	Orbit. Action Mob Hdlle Jig Saw	123.00
3238VS	Unv. Shank Mult. Orbit. Jig Saw	109.00
1651	7 1/4" Cir. Saw, 13 amp	99.00
1654	7 1/4" Pivoting Circ. Saw	99.00
1632VSK	Panther Recp. Saw	128.00
1581VS	Jig Saw	129.00
1581DVS	Dustless Jig Saw	175.00

DRILLS

3050VSRK	3/8" 9.6 V Cordless Drill w/Clutch & extra battery pack	129.00
3000VSRK	9.6 Cordless Drill	129.00
1158VSR	3/8" Var. Spd. Rev. Drill	69.00
9166VSR	1/2" VSR Mighty Midget Drill	109.00
9164VSR	3/8" Mighty Midget Drill	99.00
1196VSR	3/8" VSR Hornet Hemmer Drill	109.00
1198VSR	1/2" VSR 2 spd. Hammer Drill	129.00

ROUTERS

1601	1 hp Router	99.00
1602	1 1/2 hp Router	119.00
1604	1 3/4 hp Router	119.00
1606	D-Handle, 1 3/4 hp Router	138.00
90300	Fixed Base Router, 3 3/4 hp	309.00
90300M	Fixe Base Router	280.00
1608	Trim Router	87.00
1608L	Laminate Trimmer	89.00
1609K	Installers Kit	168.00
1611	Plunge Router, 3 hp	195.00
1611	Plunge Router, 3 1/2 hp, 220 Volt	257.00

SANDERS

1273 DVS	4"x24" Variable Speed Belt Sander	185.00
	Sanding Frame for 1273 DVS	98.00
3270D	3"x21" Dustless Belt Sander	135.00
1272	3"x24" Belt Sander	159.00
1272D	3"x24" Belt Sander w/Dust Collector	165.00
1273	4"x24" Belt Sander	168.00
1273D	4"x24" Belt Sander w/Dust Collector	175.00
1290	Finishing Sander, 1/2 sheet	119.00
1290D	Finishing Sander, 1/2 sheet dustless	125.00
3258	3 1/4" Power Planer	125.00

HITACHI

CBFB	Compound Miter Saw	475.00
CB75F	Resaw Bandsaw	1620.00
F1000	Planer/Jointer	1520.00
C15FB	15" Miter Saw	380.00

PORTER CABLE

No. 555	Plate Jointer w/case	160.00
---------	----------------------	--------

AEG

HBSE75S	3"x21" VS Belt Sander	135.00
	Sanding Frame	65.00
OF550	1 hp Plunge Router	168.00
EZ502	Cordless Screwdriver	65.00

FREE FREIGHT

Denver — (303) 355-2391

CALL TOLL FREE
1-800-748-1945

VISA and MASTERCARD ACCEPTED

AVIATION/INDUSTRIAL SUPPLY
P.O. Box 38159 • Denver, CO 80238

READER SERVICE NO. 92

DOWEL MATE

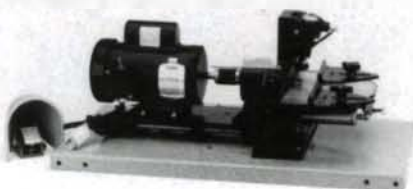

PANEL TEMPLATE

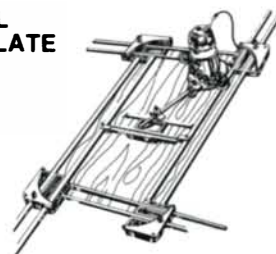

RING MASTER



ROUTER MATE



PRESENTING THE PNI FAMILY OF FINE WOOD WORKING MACHINES

- **DOWEL MATE** for tough joints that are perfectly aligned. The Dowel Mate is the answer. A single step on the foot pedal first clamps the wood & then shoots in two dowel holes. Air clamp & air feed.
- **RING MASTER** Test your imagination...Cut rings out of a board with the renowned Ring Master & produce any hollow cylindrical shape in wood. Create beautiful wood works of art from start to finish.
- **PANEL TEMPLATE** Produce something special...Route decorative panel designs in seconds. 32 different corner designs, a side design & arc attachment are available to create unique panels.
- **ROUTER MATE** converts portable routers to precision Routing machines.
 - Route Faster • More Accurately • More Profitably with the All New Router Mate.

See your woodworking machinery dealer or call toll free for an informative brochure.



PORTA-NAILS, INC • PO BOX 1257 • WILMINGTON, NC 28402, USA • 919 762-6334 • 1-800 634-9281

READER SERVICE NO. 55

You Want Great Sanders - Come To Us!

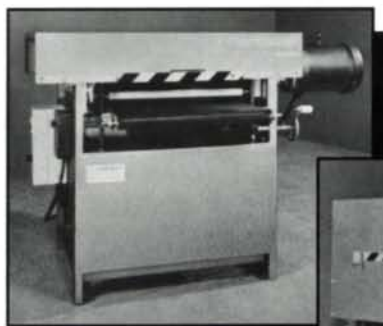

TurboBrush



UltraSand



SandStar



Quality Made IN THE U.S.A.

KUSTER MFG
BELLE MEAD, NEW JERSEY

For information & literature call today:
1-800-458-7837

READER SERVICE NO. 40

THE ARTISAN'S SAW



Casters Set and Stock Pusher shown on Model 63 are Optional.

Artisan's Saw also available with 50" cutting capacity

Strikingly different. A new standard for the industry.

As "the" producer of top end industrial woodworking machines since 1921, Powermatic now focuses their engineering expertise and resources for the craftsman, contractor and home hobbyist.

- Industrial Quality Vega Fence System provides unsurpassed rigidity for accuracy & speed
- T-Slot Miter Gauge for increased accuracy and flexibility in stock width capabilities
- Built-In Dust Shroud for shop cleanliness

- Cast Iron Grate Extensions provide ruggedness for increased accuracy and longevity

- Unitized Wiring System readily removed for portability

- The Powermatic Name for value and service

You'll find no better quality or value . . . anywhere. For just a little more than you'd spend on a run-of-the-mill machine.

Talk to your Powermatic distributor today. For those who want the

best: the Powermatic 10' Artisan's Saw. Truly a new standard for the industry.

The Artisan's Choice
POWERMATIC 

A Division of DeVlieg-Bullard, Inc.
McMinnville, Tennessee 37110
800/248-0144 □ 615/473-5551
TELEX - 554455
FAX # 615/473-7819

DELTA	
34-782	10" 3 HP UNISAW W/ UNIFENCE
34-783	10" 5 HP 3 PH W/ UNIFENCE
43-375	3 HP 1 PH HD/Shaper
37-350	8" D-20 Joiner W/STAND
31-730	6" Belt 12" Disc
33-890	12" RADIAL ARM SAW
40-601	18" VS SCROLL SAW
33-990	10" RADIAL ARM SAW
22-661	DC 33 13" PLANER
50-179	3/4 HP DUST COLLECTOR
50-180	1 HP DUST COLLECTOR
50-181	2 HP DUST COLLECTOR
34-985	1 PH STOCK FEEDER 110V
34-994	1 PH STOCK FEEDER 230V
34-995	3 PH STOCK FEEDER 230V
33-150	8-1/4" SAW BUCK
34-444	10" CONTR. SAW COMPLETE
31-380	4" X 132" EDGE SANDER
34-670	10" MOTORIZED SAW
40-150	15" SCROLL SAW
31-050	1" X 30" SANDER
23-700	WET DRY GRINDER
31-460	4" BELT 6" DISC
17-900	16-1/2" DRILL PRESS
34-697	DELTA UNIFENCE

EMGLO		
AM39-HC4V3/4 HP TWIN TANK		
AM78-HC4V1-1/2 HP TWIN TANK		
2568		
298		
BOSCH		
1611	3 HP PLUNGE ROUTER	\$193
1604	1-3/4 HP ROUTER	119
1604K	1-3/4 HP ROUTER KIT	159
1606	1-3/4 HP D-HANDLE ROUTER	135
1608	5.6 AMP. LAM. TRIMMER	79
1609K	3 IN 1 TRIMMER KIT	163
3270D	3 X 21 SANDER W/BAG	126
1272	3 X 24 SANDER	163
1272D	3 X 24 SANDER W/BAG	168
1273DVS	4 X 24 VARIABLE SPEED SANDER W/BAG	188
3050VSRK	9.6V CORDLESS W/CLUTCH	129
91066	1/2" MIGHTY MIDGET VSR	108
1347	4-1/2" MINI-GRINDER	84
1654	7-1/4" SAW W/CT BLADE	98
1581VS	TOP HANDLE JIG SAW	127
1632VSK	VS RECIP. SAW W/CASE	129

HITACHI		
C-8FB	8-1/2" COMPOUND MITER SAW	\$469
C-15FB	15" MITER SAW	389
TR-12	3HP PLUNGE ROUTER W/ACCES. VALUE AT \$60	169

FREUD		
JS-100	PLATE JOINER W/CASE	\$153
EC-900	DOOR SYSTEM SHAPER SET	278
94-100	DOOR SYSTEM ROUTER SET	158
FB-107	7 PC. FORSTNER BIT SET	49
FB-100	16 PC. FORSTNER BIT SET	149
FT2000	ROUTER	185

LEIGH DOVETAIL JIGS	
D1258-12—List 314.00—Sale 265.00	
D1258-24—List 375.00—Sale 298.00	
LEIGH INSTRUCTIONAL VIDEO—SALE 29.00!!	

MAKITA		
LS1430	14" MITER SAW	439
5402A	16-5/16" CIRC. SAW	329
5201NA	10-1/4" CIRC. SAW	299
5077B	7-1/4" HYPOID CIRC. SAW	139
5007NB	7-1/4" CIRC. SAW	114
5007NBA	7-1/4" CIRC. SAW W/ELEC. BRAKE	124
1900BW	3-1/4" PLANER W/CASE	113
1100	3-1/4" PLANER HD W/CASE	210
2708W	8-1/4" TABLE SAW	257
3612BR	3 HP PLUNGE ROUTER	199
3601B	1-3/8" HP D-HANDLE ROUTER	137
9030	1-1/8" X 21" BELT SANDER	135
9900B	3" X 21" BELT SANDER W/BAG	139
9924B	3" X 24" BELT SANDER	139
9924DB	3" X 24" BELT SANDER W/BAG	145
9401	4" X 24" BELT SANDER W/BAG	162
JR3000V	RECIPRO SAW W/CASE	121
6510LVR	3/8" VSR DRILL	85
6093DW	3/8" CORDLESS KIT 2SP VSR	129
EXTRA	9.6 VOLT BATTERY W/PURCHASE	26
B04510	4-3/8" X 4" FINISH SANDER	48

SAW BLADES	
5/8" BORE, INDUSTRIAL GRADE, CARBIDE TIPPED	
LU72M010	Gen. Purp. A.T.B. 10" 40 58 39
LU81M010	Gen. Purp. 10" 40 45 43
LU82M010	Cut-off 10" 50 77 45
LU84M011	Combination 10" 50 55 42
LU85M010	Super Cut-off 10" 80 95 57
LM72M010	Ripping 10" 24 57 38
LM73M010	Cut off 10" 60 70 44
LU87M010	Thin Kerf 10" 24 68 39
LU88M010	Thin Kerf 10" 60 74 44
LU98M010	Ultimate 10" 80 107 79
LU85M010	Non-ferrous metal 10" 72 87 65
PS203	Plywood 7-1/4" 40 36 25
PS303	Gen'l Purp. 7-1/4" 24 25 19
DS306	6" Dado - Carbide 184 105
DS308	8" Dado - Carbide 196 109
F0	1-3/4"x1/8" Biscuits 1000 Qty 32 27
F10	2-1/8"x3/8" Biscuits 1000 Qty 32 27
F20	2-3/8"x1" Biscuits 1000 Qty 34 27
FA	Assorted Biscuits 1000 Qty 34 27
WC104	4 pc. chisel set w/cse. 1/4"-1" 54 39
WC106	6 pc. chisel set w/cse. 1/4"-1" 73 52
WC110	10 pc. chisel set w/cse. 1/4"-1-1/2" 119 79
FB100	16 pc. forstner bit set 1/4"-2-1/4" 284 149
94-100	5 pc. router bit door system 230 155
JS100	Biscuit Joiner w/cse. 300 153
ALL ROUTER BITS 35% OFF!!	

PORTER—CABLE		
330	SPEED BLOC SANDER	\$ 55
351	3 X 21 SANDER	119
352	3 X 21 SANDER W/BAG	124
360	3 X 24 SANDER W/BAG	175
361	3 X 24 SANDER	169
362	4 X 24 SANDER W/BAG	185
363	4 X 24 SANDER	181
617	7-1/4" SAW 13 AMP	114
315	7-1/4" SAW 13 AMP	114
314	4-1/2" TRIM SAW	124
690	1-1/2 HP ROUTER	121
9118	PORTA PLANE KIT	185
555	PLATE JOINER W/CASE	159
505	1/2 SHEET PAD SANDER	109

POWERMATIC *III*

Model 66 Table Saw



50" Biesemeyer Rip Fence, 3HP 1PH or 5HP, 3 PH motor

Model 180 18" Planer

7 1/2 HP, 3 PH OR 5 HP, 1 PH motor
Knife Grinder, Sectional Roll and Chipbreaker.



ENTIRE LINE AVAILABLE AT UNBELIEVABLE DISCOUNTS. WHEN YOU CALL ASK FOR TOM YOU HAVE THE OWNER. NOT JUST AN ORDER TAKER.

TARHEEL FILING CO., INC.
CALL TOLL FREE 1-800-322-6641
LOCAL 919-831-2678
FAX 919-831-9980

MAIL CHECK OR MONEY ORDER TO TARHEEL FILING
 3400 LAKE WOODARD DR., RALEIGH, NC 27604

PLEASE MENTION THIS AD WHEN YOU CALL!
 ORDERS PLACED BY VISA, MASTERCARD, CASHIER CHECKS OR MONEY ORDERS WILL BE SHIPPED THE SAME DAY. ALLOW 2-3 WEEKS FOR PERSONAL OR COMPANY CHECKS.

FREE FREIGHT ON PORTABLES (CONT. U.S.A. ONLY).
 NO COD'S PLEASE. ERRORS SUBJECT TO CORRECTION

*Buy Direct From The Manufacturer And **SAVE!***

Buy 12 "EVER-LAST" Belts...
Get 12 Belts FREE!

Need ROLLS, WIDE BELTS, DISCS, SLEEVES, STROKE BELTS, etc. Write for catalog.

Belts available in 36, 50, 60, 80, 100, 120, 150, 180, 220, 320 grit sizes. Please specify grit sizes when ordering, otherwise an assortment will be supplied.

<input type="checkbox"/> 1" x 30" . . .	\$15.50/Doz. + 12 FREE
<input type="checkbox"/> 1" x 42" . . .	\$15.70/Doz. + 12 FREE
<input type="checkbox"/> 2" x 48" . . .	\$19.50/Doz. + 12 FREE
<input type="checkbox"/> 2 1/2" x 16" . . .	\$16.50/Doz. + 12 FREE
<input type="checkbox"/> 3" x 18" . . .	\$16.75/Doz. + 12 FREE
<input type="checkbox"/> 3" x 21" . . .	\$17.75/Doz. + 12 FREE
<input type="checkbox"/> 3" x 24" . . .	\$18.00/Doz. + 12 FREE
<input type="checkbox"/> 4" x 21" . . .	\$19.95/Doz. + 12 FREE
<input type="checkbox"/> 4" x 21 3/4" . . .	\$20.00/Doz. + 12 FREE
<input type="checkbox"/> 4" x 24" . . .	\$21.50/Doz. + 12 FREE
<input type="checkbox"/> 4" x 36" . . .	\$24.95/Doz. + 12 FREE
<input type="checkbox"/> 6" x 48" . . .	\$32.95/1/2 Doz. + 6 FREE

Other size belts on request.
 Belt Cleaning Stick . . . \$6.95 each

For Fast Delivery Call Toll Free
 1-800-428-2222 (U.S.A.)
 1-800-222-2292 (PA only)

INDUSTRIAL BRASIVES CO.
 644 N. 8th ST. • READING, PA 19612

HITACHI *Hitachi...It's Happening!* HITACHI



1/2" M 12V
(Variable Speed) **NEW!**
Super Duty!

- Electronic speed control
- 3-1/4 HP
- Spindle lock

List: \$474.00 **Special: \$235.00** ppd

Standard Equipment: 1 Straight Guide (956797), 1 Bar Holder (956792), 1 Feed Screw (956793), 1 Wing Bolt (949394Z), 2 Wing Bolts (301806), 1 Template Guide (956790), 1 Wrench (956923), 1 Straight Bit (956817Z), 1 Chuck Sleeve (956927Z), 1 Template Guide Adaptor (956756), 2 Lock Springs (947859).

1/2" M12SA
(Same as M12V but no V.S.)

List: \$437.00 **Special: \$215.00** ppd

1/2" TR-12
(3Hp) Router

List: \$354.00 **Special: \$174.00** ppd

C8FB

8-1/2" Slide Compound Saw

- 15 HP- Super duty
- Cuts up to 2-9/16" X 12"
- Electric Brake Spindle lock
- 24 Teeth carbide tipped saw

List: \$899.00 **Special \$468.00** ppd

C12FA

NEW!
C12FA
12" Miter Saw

List: \$586.00 **Special \$325.00** ppd

PHILIPPS BROS. SUPPLY, INC.
 Construction and Industrial Supplies

2525 Kensington Avenue, Buffalo, N.Y. 14226
 716/839-4800 Fax: 716/839-4051
 Call Toll Free 1-800-888-PBS1 (7271)

Fine Woodworking on... series

Our *Fine Woodworking on...* books represent 10 years of the best woodworking information —straight from the pages of *Fine Woodworking* magazine. Each book is only \$7.95. To order, just write the product number on the order form.

Fine Woodworking on...

Proven Shop Tips #070038

Joinery #070031

Boxes, Carcasses and Drawers #070032

The Small Workshop #070033

Planes and Chisels #070034

Bending Wood #070035

Making Period Furniture #070036

Woodworking Machines #070037

Chairs and Beds #070045

Tables and Desks #070046

Making and Modifying Machines #070047

Finishing and Refinishing #070048

Things to Make #070049

Carving #070050

Hand Tools #070051

Wood and How to Dry It #070052

Spindle Turning #070057

Faceplate Turning #070058

Marquetry and Veneer #070059

Woodshop Specialties #070060



Real solutions to real woodworking problems

Next time you find yourself in the workshop scratching your head over some knotty woodworking problem, take heart. This volume brings you hundreds of solutions from those who've been there and back.

Fine Woodworking on More Proven Shop Tips represents the best of the Methods of Work column from issues 48-78 of *Fine Woodworking* magazine. As a *Fine Woodworking* reader, you know the Methods of Work column as the place where woodworkers like you share their shop-tested ideas about tools, materials, jigs and fixtures.

We first compiled the best of the Methods of Work column in 1985 into *Fine Woodworking on Proven Shop Tips*. That bestselling book includes contributions from the first 47 issues of *Fine Woodworking*. *More Proven Shop Tips* picks up where the first book left off, with tips on hand tools, grinding, gluing and clamping, joinery, lathe jigs and fixtures, power tools and more. You'll also find 18 ingenious sharpening innovations. If you've ever thought, "There's got to be a better way," your search ends here. SOFTCOVER, 96 PAGES, 295 ILLUSTRATIONS, \$7.95, #070109

WOODWORKER'S DREAM

EXOTIC & DOMESTIC HARDWOODS

SAWN VENEER AND LUMBER

1/8", 1/4", 1/2", 1", or 2" & Custom Sizes

OVER 30 SPECIES AVAILABLE
SANDED, ROUGH OR RESAWN

NO MINIMUM ORDER • QUANTITY DISCOUNTS

• COMPLETE SAWMILL SERVICES AVAILABLE •

CALL US TOLL FREE (800) 247-6931

PENNSYLVANIA RESIDENTS CALL (215) 759-2837

A DIVISION OF MARTIN GUITAR CO., NAZARETH, PA 18064

READER SERVICE NO. 14

NOW YOUR COMPACT JOINTER CAN GROW TEN FEET LONG!

JOINER'S LEDGE
SCHULER UNIVERSAL AUTO-ALIGNING TABLE EXTENSION SYSTEM

U.S. PATENT 4,877,491

JOINER BED EXTENSION KIT
\$ 3000 JK \$360.00

CALL 217/328-4189

WE SIMPLY GET IT STRAIGHT.

SCHULER TOOLWORKS LTD. P.O. BOX 547 URBANA, IL 61801 USA

• PRECISE ALIGNMENT IS AUTOMATIC.
• SYSTEM ADAPTS TO VIRTUALLY ANY JOINTER.
• INITIAL INSTALLATION TAKES ABOUT ONE HOUR.
• SYSTEM MOUNTED OR REMOVED IN TWO MINUTES.
• ACCESSORY KITS ADAPT SYSTEM TO OTHER MACHINES.

READER SERVICE NO. 158

You Design The Molding...

We'll Make The Knives!

Shaper/Molder Knives

Knives made for all woodworking machinery

• 3 Day Shipping •
MasterCard/Visa/C.O.D.



Counselor Profiles

40 Lawlins Park, Wyckoff, NJ 07481-1443

1-800-635-6285

FAX: 201-848-9867

READER SERVICE NO. 18

Protect Your Back Issues

SLIPCASES FOR YOUR BACK ISSUES. Bound in blue and embossed in gold, each case holds at least 7 issues of *Fine Woodworking* (a year's worth), and costs \$7.95 (\$21.95 for 3, \$39.95 for 6). Add \$1.00 per case for postage and handling. Outside the United States, add \$2.50 each (U.S. funds only). PA residents add 6% sales tax. Send your order and payment to the address below, or call toll-free, 1-800-972-5858, and use your credit card (minimum \$15). Jesse Jones Ind., Dept. FWW, 499 E. Erie Ave., Philadelphia, PA 19134. (No P.O. boxes, please).

We are NOT NO. 1 in catalogue and advertising. We are NO. 1 in QUALITY, PRICE & WARRANTY — You check! **CALL 1-800-654-7702**

Credit Card Orders

SHAPER / ROUTER MACHINE Extra Large Table Only \$745	12" AUTO PLANER Sale \$339 Free Carbon Set	16" AUTO PLANER Sale \$745	20" AUTO PLANER AP200A \$1165 AP200 \$1845 H.D.	SUPER HEAVY DUTY 10" TABLE SAW Sale \$835 w/72" Biesemeyer fence \$1040
1", 3/4" & 1/2" spindles, 1/4" & 1/2" router bit chucks, 3HP motor, 25" x 22" milled table, T-slot miter gauge, 8000 / 11000 reversible 2 speeds, 3" spindle travel, independent precision fence, 6" insert opening, side & top spring hold-downs, 2 table rings for irregular surface. Optional 10" roller extensions.	2HP, 115V motor, 0.2" - 6" cutting range, 1/8" max cut, 8000 RPM, 26.2 FPM auto feed.	Super 16" x 8" capacity, 3HP motor, 3 blades, 2 auto feed rates. Triple belt & chain driven.	20" x 8" super capacity, 5HP motor, 4 blades, 2 auto feed rates. Triple belt & chain driven.	<ul style="list-style-type: none"> • Heavy duty constructions • Triple V-belt driven • Precision fence system • 3HP motor, 4200 RPM • Built in dust chute
	6" x 12" SANDER Sale \$385	8" JOINTER JT860A \$645 JT860 \$725 H.D.	DUST COLLECTOR 2HP \$284 3HP \$378	DRUM BRUSH SANDER Sale \$285
	Big 12" sanding disc, 6" x 48" sanding belt, 2HP motor, 3600 RPM, 17" cast iron table.	9" x 66" extra long bed, 2HP motor, 4 blades. Double belt driven 38" center mounted fence.	3 intake holes (4"), 2HP motor, 3600 RPM, 1250 CFM capacity, 2 bags, 78" height.	2HP motor, 1725 RPM, 6" x 9" brush head, 4" x 9" air drum, optional heavy duty stand.
				18" BAND SAW SB700 \$695 SB700A \$895 H.D.
				Heavy duty constructions, 11" cutting depth, resawing & scrolling blade, 18" table with fence.

TCM Industries, Inc. 322 Paseo Sonrisa, Walnut, CA 91789
For Free Catalogue Call (714) 594-0780

READER SERVICE NO. 160

CLASSIFIED

The CLASSIFIED rate is \$5.75 per word, minimum ad 15 words. All payments must accompany orders; all are noncommissionable. The WOOD & TOOL EXCHANGE and SITUATIONS WANTED are for private use by individuals only; the rate is \$8.00 per line. Minimum 3 lines, maximum 6 lines, limit 2 insertions per year. DISPLAY CLASSIFIED rates on request. Send to: *Fine Woodworking*, Advertising Dept., Box 5506, Newtown, CT 06470-5506. FAX (203) 426-3434. Deadline for the *May/June* issue is February 23.

Business Opportunities

LOOMBUILDER RETIRING. Seeks creative person to purchase turn-key operation. Fire-side Fiberarts, 625 Tyler St., Port Townsend, WA 98368.

ESTABLISHED ARCHITECTURAL WOODWORK business, commercial/residential, in Albany, NY area. Gross 400K/year. PO Box 174, Sand Lake, NY 12153.

LET THE GOVERNMENT FINANCE YOUR WOODWORKING—related small business. Grants/loans to \$500,000. Free recorded message: (707) 449-8600. (LN6)

FOR SALE: COMPLETELY EQUIPPED operating cabinet shop, doing custom work and museum reproduction. All equipment & tools. Phila. suburb. (215) 789-9000.

**DEALER
INQUIRIES INVITED**



We are a direct importer stocking all quality hand tools needed for a woodworking tool store or specialty department. Resale only—no enduser sales.
Robert Larson Company, Inc.
33 Dorman Avenue
San Francisco, CA 94124 (415) 821-1021

Help Wanted

CAMP WEKEELA FOR BOYS & GIRLS, Canton, Maine seeks experienced woodworking instructors, (age 20+) June 18 — Aug. 19. Contact: Eric/Lauren Scoblionko, 130 S. Merkle Rd., Columbus, OH 43209. (614) 235-3177.

WOODWORKING INSTRUCTOR to teach and live-in at summer camp for teenagers in New Milford, CT. July — Aug. 1990. Buck's Rock, 193 N. Detroit Ave., N. Massapequa, NY 11758. (516) 293-1229.

FURNITUREMAKER/CABINETMAKER. Excellent opportunity in a small high-quality shop serving the high-end business interior of Los Angeles. Min. 5yrs exper. (213) 665-6557.

APPRENTICE VIOLIN MAKERS and restorers. Positions available with finest rare violin shop in the country. Good salary and benefits, excellent training program. Professional woodworking experience required. Must be willing and able to learn. Bein & Fushi Inc., 410 S. Michigan Ave., Chicago, IL 60605.

WANTED: AN EXPERIENCED CABINETMAKER for architectural woodworking (lower Fairfield City, CT.) Call (203) 866-7715.

EXPERIENCED CABINETMAKER/FINISHER/PROJECT LEADERS—for planning, fabricating and installing high-end furniture and architectural millwork. Positions from \$15,000 to \$30,000 for self-motivated individuals with independence to contribute to growing business. Excellent benefits. Send resume: Woodfellows, 8512 Fairway Pl., Middleton, WI 53562.

APPRENTICE CABINETMAKER

The Colonial Williamsburg Foundation is seeking candidates interested in hand production of 18th-century Virginia furniture. Position includes daily presentations to the public, hand planing, pit sawing, joinery work, research and design of furniture. Requires high school education, good public contact skills, woodworking experience using hand tools, manual dexterity and good research skills. Must commit to a 6 year apprentice training program for advancement to the journeyman level and have ability to work a flexible schedule including weekends and holidays. Present skills/experience may substitute on a year-for-year basis toward the 6 year program. Competitive salary and excellent benefits. Submit Colonial Williamsburg Application and Resume to:

Employment Specialist
The Colonial Williamsburg Foundation
P.O. Box C, Williamsburg, VA 23187

Applications may be obtained by calling: (804) 220-7000 EOE/AA

Instruction

LEARN WOODEN BOAT BUILDING AND DESIGN. Two full-time residential programs that offer intensive training in a creative but disciplined environment. V.A. approved. Accredited member, NATTS. Financial aid available. Equal opportunity enrollment. The Landing School, Box 1490F, Kennebunkport, ME 04046. (207) 985-7976.

LEARN TRADITIONAL WOODEN BOAT-BUILDING. We offer a six-month program, summer seminars, weekend workshops, and build-your-own boat program. Call or write for our catalog. Northwest School of Wooden Boatbuilding, 251 Otto St., Port Townsend, WA 98368. (206) 385-4948.

INTENSIVE, DISCIPLINED, IN-STUDIO TRAINING PROGRAMS in 18th century Chippendale furnituremaking, utilizing traditional handwork/machinery. Potential artisans study and create traditional designs, joinery, prototypes, construction and embellishments of important pieces. Studio has adjacent working gallery. Tuition. 7 North Home Ave., Tipton, PA 19562. (215) 682-4204.

PRESERVATION CARPENTRY—one or two-year course. Preserve and restore pre-20th-century buildings. CABINET & FURNITURE MAKING—two years, custom furniture construction. Traditional styles; hand joinery and embellishment. PIANO TECHNOLOGY—two years. Tuning, action repairs, and rebuilding. VIOLIN MAKING & RESTORATION—three years for making; optional fourth year for repair/restoration. Financial aid for qualified students. Accredited member NATTS. NORTH BENNET STREET SCHOOL, 39 North Bennet St., Box A, Boston, MA 02113. (617) 227-0155.

INDIVIDUAL INSTRUCTION learning furniture making from log to finished product with classical hand joinery emphasized. Instructor: graduate John Makepeace School, Dorset, Eng. Contact Geoffrey Noden. (609) 890-8152.

VILLA MARIA WORKSHOPS, Aug. 12-18, 1990; carving classes in caricature, relief, waterfowl, songbird, stylized, marquetry. PO Box 37051, Minneapolis, MN 55431.

CALL OR WRITE FOR A BROCHURE detailing our successful in-residence Windsor chairmaking and Shaker furniture workshops. Five-day classes scheduled for April and May. The Dovetail Joint, 1332 Harlem Blvd., Rockford, IL 61103. (815) 965-6677. Peter Cullum, instructor.

EVER WANTED TO BUILD A WOODEN BOAT? Come to Maine. Take our six-week course. Rockport Apprenticeship. Box 539F, Rockport, ME 04856. (207) 236-6071.

APPRENTICESHIP IN PROFESSIONAL FINE FURNITURE MAKING with the prominent Jeffrey Greene Design Studio—realistic preparation for an uncompromisingly vital career as an independent artisan designing, making, marketing the very finest furniture in solid walnut/rosewoods. Tuition. New Hope, PA. (215) 862-5530. Call don't write. Monday thru Friday, 9:30-4:00.

WOODWORKING & LUTHERY SCHOOL. One year intensive woodworking program. Or four-month guitar-building course. Financial aid. Accredited member NATTS. Brochure available Roberto-Venn School of Luthiery, 4011 S. 16th St., Phoenix, AZ 85040. (602) 243-1179.

APPRENTICE WITH MASTER CRAFTSMEN. Unique in-shop experience. Woodworking and other crafts. Flexible year round program. Baulines Craftsman's Guild-FW, Schoonmaker Point, Sausalito, CA 94965. (415) 331-8520.

12 MONTH ONE-ON-ONE APPRENTICE-SHIP with master craftsman covering all phases of fine furnituremaking. Basic skills required. Send resume: Michael Coffey, 1 Cottage St., Easthampton, MA 01027.

LEARN TO TURN WOOD. Precision lathe work for fun and fine products taught by JAMES L. COX WOODWORKING SCHOOL. Free brochure. Rd 2, Box 126, Honey Brook, PA 19344. (215) 273-3840.

THE HYMILLER SCHOOL OF FINE FINISHING/REPAIR AND HAND JOINERY. One two-week intensive in-shop training will give you all the necessary knowledge to start your own business. Send \$5 for complete info package. 3rd generation master craftsman. 912 Lakeshire Dr., Fairfield Glade, TN 38555. (615) 484-9309. Weekend courses now available.

SIX-MONTH APPRENTICESHIP PROGRAM in woodworking. Intensive training encompasses designing, producing, and marketing of fine furniture/cabinetry. Maxwell & Kelly Furniture Co., Philadelphia, PA. (215) 988-9065.

GILDING WORKSHOPS with Frances Binnington. FINISHING FOR ANTIQUE FURNITURE and classes in Chinoiserie with Peter Binnington. The Binningtons have run their restoration shop in London, England for over a decade and now bring their workshops to Garrett Wade & Co., Inc., NYC. For details please call Kelly at P&F Binnington Inc. (609) 392-5252.

FINE CABINETMAKING

Courses with master craftsman in long established professional and teaching workshop in beautiful historic area. For Prospectus call U.K. 0803 862861
Christopher Faulkner
Ashridge Workshops, Dartington,
Totnes, Devon TQ9 6EW, England.

**Study
Woodworking**

June/July/August Summer Workshops
One to Eight Day Workshops

**RUSS ZIMMERMAN'S
HOUSE OF WOODTURNING**

Turner's Workshops and Supplies.
Call or write for free brochure.
RFD 3, BOX 242
PUTNEY, VERMONT 05346
802-387-4337

For a catalogue describing our two year educational program in the fine art of furniture making, contact:

GENOA
Box 250F
Academy Street
Genoa, NY 13071
Furniture Making Education,
Studios and Gallery
315-497-3000
315-889-7291

GENOA does not discriminate with regard to race, religion, color, creed, national origin, sex, sexual orientation, marital status, age or handicap.

Finishes

BEHLEN WOOD FINISHING PRODUCTS, WATCO, DEFT, WATERLOX, KWIK, MIN-WAX. Orange shellac flakes bulk \$6.99 per lb (best quality). Harper Hardware — since 1898, 1712 E. Broad St., Richmond, VA 23223. (804) 643-9007.

SPRAY-ON-SUEDE LINING. Finish any project with a soft touch. Free brochure (sample enclosed). Doner Products, Ilene Court—Bldg. 8F, Belle Mead, NJ 08502. (800) 336-6537.

POLYESTER WOOD FINISH. A complete line of professional products for producing the ultimate piano/high-tech finish. Clears, custom colors. Catalog \$2. Donald M. Steiner Dept. FW, 800 Messenger Rd., Grants Pass, OR 97527. (503) 846-6835.

**Swedish Wood
Dyes** Beautiful, brilliant colors. Imported and unique. Inexpensive, non-toxic. Professionally used. \$3 for sample and brochure.

**Thore Henningson, P.O. Box 6004,
Dept. FW, Rockford, IL 61125**

Glues/Adhesives

HIDE GLUE-ALL GRADES, 5# AND UP. Bjorn Industries, Inc., Box 1280, Matthews, NC 28106. (704) 845-2288.

Building?	Restoring?	Repairing?
use CHEM-TECH T-88 the epoxy professional's use Strength and reliability proven in boats and aircraft over 15 years. Introductory offer 1/2 pt. of T-88 \$9.95. Technical staff on call to answer your questions. Call or write.		
		4669-F Lander Rd Chagrin Falls OH 44022
		(216) 248-0770

Accessories

CARBIDE LATHE CHISELS. World's finest. Free brochure. Unique Tool, HCR Box 3103, Benson, AZ 85602.

BYROM ROUTER BITS-30% DISCOUNT, over 780 items, plus weekly phone specials. American Consumer Products, Box 372-FW, Ames, IA 50010. (800) 288-7095.

THE BEALL TOOL CO.

**The Beall
Wood Threader**



The ultimate wood threading device. Attaches to router & makes perfect threads in 5 right hand sizes and 3 left. Write or call: Dept. FW, 541 Swans Rd., NE, Newark, OH 43055, 614-345-5045, 1-800-331-4718.

THE FINE GOLD LEAF PEOPLE™

Genuine, Imitation and Variegated Sheets & Rolls
Brushes, Supplies & Technical Books
IN USA: Three Cross Street
Suffern, NY 10901-4601
1-800-283-5323
IN CANADA: 508 Douglas Avenue
Toronto, Ontario, M5M 1H5
416-787-7331
"WORK WITH THE BEST IN THE BUSINESS"

**CUSTOM
BRANDING
IRONS**



DRILL PRESS or HANDHELD
250 to 800 watts
SEND \$1.00 FOR BROCHURE
ENGRAVING ARTS (707) 984-8203
P.O. Box 787 FAX (707) 984-8045
Laytonville, CA 95454

SEAR'S-STYLE MOLDING CUTTER HEAD, molding knives, shaper cutters. Available from manufacturer, save 50%. Corob. See our ad on page 7.

Plans & Kits

QUONSET STYLE STEEL BUILDINGS. Ideal for workshops. Easy to erect. Buy factory direct and save up to 40%. Straight sides and rounded tops. U. S. ARCH BUILDINGS, (800) 527-4044, Texas (800) 442-1817.

EDGE BANDER—build your own hot-air edgebander. For complete plans send \$15 to Edgebander, Box 144, Osler, Sask, S0K 3A0.

SOMETHING NEW IN WOODWORKING PLANS. Oak swing-arm lamp, roll-top cassette tape holder, unique fold-away recipe box, and lots more. Free catalog! Thompson House, 1807 Grove Rd., El Cajon, CA 92020.

WINDSOR CHAIRS! Steambent solid oak top and arm rails. Send \$1 (refundable) to Red House, 878 Coldbrook NE, Grand Rapids, MI 49503.

FULL-SIZE PROFESSIONAL PLANS - Catalog \$3. Over 200 professionally-designed plans for building fine furniture. Furniture Designs, Inc., CK-30, 1827 Elmdale Ave., Glenview, IL 60025.

HAMMERED DULCIMER PLANS! By noted builder Charlie Alm. Best book on subject. \$19.95. Woodworks, Box 428, Dept. FW, Brookston, IN 47923. (317) 563-3504.

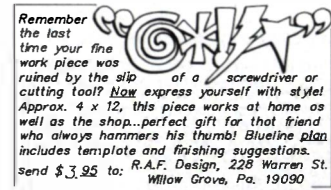

Remember the last time your fine work piece was ruined by the slip of a screwdriver or cutting tool? Now express yourself with style! Approx. 4 x 12, this piece works at home as well as the shop...perfect gift for that friend who always hammers his thumb! Blue line plan includes template and finishing suggestions. Send \$3.95 to: R.A.F. Design, 228 Warren St. Willow Grove, Pa. 19090

Toys Plans & Kits

MAKE WOODEN TOYS, whirligigs, door harps, doll houses, clocks, music boxes, weather instruments, crafts, furniture with our plans, parts, kits, supplies. Catalog \$1. (614) 484-4363. Cherry Tree Toys, Belmont, OH 43718-0369.

Services

SUNDIAL TEMPLATES individually computed for your location. Guaranteed accurate. Send \$22.50; latitude, longitude, and time zone. Newport Engineering, Box 3178, Durango, CO 81302.

Musical Supplies

GUITAR SUPPLIES, KITS AND REPAIR TOOLS. Hot Stuff™ super glues, finishing supplies, Free 96-page catalog. Stewart-MacDonald, Box 900F, Athens, OH 45701. (800) 848-2273.

VIOLIN, GUITAR, banjo, mandolin-making materials, accessories, books. Catalog, \$1. International Luthiers Supply, Box 580397, Tulsa, OK 74158.

Publications

WOODWORKERS: LEARN BASIC METALWORKING WITH PROJECTS IN METAL magazine. It's an indispensable tool for learning more about metal crafts. Small, instructive projects, each complete in one issue, features on metalworking technique, plus tips to save you headaches, time, and money. \$17.50 a year (6 issues) check or charge card. PROJECTS IN METAL, Dept D23, PO Box 1810, Traverse City, MI 49685. Call 800-447-3712.

INFORMATIVE CATALOG FOR WOODWORKERS, woodcarvers, upholsterers, antique restorers. Many unusual, hard-to-find items. Send \$1 to Van Dyke's, Dept. 71, Woodsocket, SD 57385.

THE TOOL CHEST CRAFTSMAN LIBRARY CATALOG for both the professional and amateur.

- 100's OF BOOKS COVERING
 - Woodworking - All Aspects
 - Home Remodeling & Maintenance
 - Tools & Their Uses
 - Projects For Home & Recreation
 - Contracting

To order your catalog send \$2.00 (refundable with 1st order) To: THE TOOL CHEST Dept. T 45 Emerson Plaza East Emerson, NJ 07630

Hand Tools

TOOLS—ANTIQUE & USED—STANLEY. Quality selection of scarce handtools for collectors and woodworkers—planes, scrapers, spokeshaves, saws, chisels, levels, rules, unusual items, etc. Complete, working tools. Satisfaction guaranteed. Prompt, postpaid service. VISA/MC. Current illustrated list—\$2. Subscription \$8 per year, 5 lists. Bob Kaune, Dept. C, 511 W. 11th., Port Angeles, WA 98362. (206) 452-2292.

NORRIS REPLICA BRONZE AND EBONY PLANES. Stanley #444 dovetail plane, \$425. Apricot Tools, 3025 E. Banbury Rd., S.L.C., UT 84121. (801) 943-6905.

GERMAN MASTER JOINERS BENCH was \$1200, on special \$799. Other benches as low as \$399. Professional advice with every purchase. Send \$5 for tool catalog and testimonials. John Hymiller Woodworker, 912 Lakeshire Dr., Fairfield Glade, TN 38555. (615) 484-9309.

JAPANESE TOOLS SINCE 1888. Free catalog. Tashiro's, 1435 S. Jackson, Seattle, WA 98144. (206) 322-2671.

FREE ILLUSTRATED CATALOG of fine quality woodworker's hand tools, books, accessories. Kreative Link, Box 2347, Sandy, UT 84901.



A UNIQUE STORE FOR THE WOOD CRAFTSMAN, PROFESSIONAL AND VALUE CONSCIOUS NOVICE.

QUALITY HAND, POWER AND STATIONARY WOODWORKING TOOLS, BOOKS AND ACCESSORIES. QUALITY • VALUE • HELPFULNESS

3241 KENNEDY RD. UNITS 7 & 8, SCARBOROUGH ONTARIO, CANADA M1V 2J9
(416) 293-8624 FAX (416) 293-2076

Power Tools

FELDER WOODWORKING SYSTEMS—Below wholesale due to repossessions. New and demos—call now and save thousands! (302) 322-2226, ask for Paul.

NEW VARIABLE SPEED HEGNER scroll saws. Also, inventory reduction sale on lathes. Call Paul for details. (302) 322-2226.

NEW DELTA MACHINERY AND QUALITY USED specials. New TEFC, 3HP, 3450RPM. Special pivot mount single phase motor. U.S. made, replaces Delta 83-651, \$265 PP. Plaza Machinery, RD2, Bethel, VT 05032. (802) 234-9673.



WIDEBELT SANDERS

For the small shop, kits or ready to run, 24" capacity, quick change belts, conveyor feed, rugged, accurate + affordable. Free information. MILLER WOODWORKING MACHINES 1110 E. QUILCENE RD. QUILCENE, WA 98376 (206) 765-3806

CHAIR, STAIR, FURNITURE BUILDERS

Single pass copy lathes, free hand lathes, and a spiral and fluting machine from KILLINGER for all your turned pieces. REED manganese bronze planes return the joy to hand planing. ULMIA workbenches, made-to-order Bandsaw Blades, and Micro-Sharp planer knife sharpening also available. Send \$100 to Willow Pond Tools, Inc. PO Box 544, Pembroke, NH 03275 (603) 225-9477

Cuts 80% off labor costs!



LINKER LINK \$295 VCS SK12 Kit

Kit Fits Skill Worm Drive Saws.

Boosts Capacity and Versatility.

- Large 12" Capacity
- Square, Smooth Cuts
- Notches—No Over Cutting

Call for brochure 1-800-635-5465

Progressive Power Tools, Corp. 303 N. Rose St. Suite 304 Kalamazoo, MI 49007

WOODWORKING Tools

1-800-872-6500

emco+USA MiniMax JET

Plus many other manufacturers

BLUE RIDGE MACHINERY AND TOOLS, INC.

P.O. Box 536 FW • Hurricane WV 25526
Showroom—2806 Putnam Avenue • Catalog \$1.00

Wood

TIGER MAPLE, FIGURED CHERRY & OAK. Heavy stock a specialty. Eastwoods Co., RD #1, Homell, NY 14843. (607) 698-4490

QUILTED & CURLY MAPLE 5/4, 8/4. Wide instrument stock available. Mac ebony lumber, boxwood logs, other exotics. Arroyo Hardwoods, 2585 Nina St., Pasadena, CA 91107. (818) 304-0021.

SELECT & BETTER: Cherry \$2.07/bf, hard maple \$1.52/bf, butternut \$2.13/bf, additional species. MasterCard-Visa. Catalog \$1. Badger Hardwoods, Rt. 1 Box 262, Walworth, WI 53184.

BLACK WALNUT LUMBER, 2000 bf, 9-in.—12-in. \$2.50/sq. ft. Other 20-in. widths and lengths. \$5/ft. D. Davis. (203) 874-7184.

PINK IVORY AND BLACK IVORY. Two of the world's finest hardwoods direct from logger/importer. M. S. Tisdale, 25000 SW 207th Ave., Homestead, FL 33081. (305) 248-0593.

RARE PINK IVORY LOGS FOR SALE. sizes up to 24-in diameter. U.S. Dept. Forestry certified (Berchemia zeheri.) Best quality shipment to USA in 15 years. Wholesale/retail. Phone (213) 542-3576, or write: Eisenbrand Inc., Exotic Hardwoods, 4100 Spencer St., Torrance, CA 90503.

MESQUITE LUMBER. SASE for prices. Include \$2 for sample. H. Nordmeyer, PO Box 68, Knippa, TX 78870.

REDWOOD LACE BURL, other Western species, squares, slabs, whole. Western lumber, figured lumber, rare woods, sample kits. SASE list. Eureka Hardwood Supply, 3346 D St., Eureka, CA 95501. (707) 445-3371.

EXOTIC WOODS, WHOLESALE to manufacturers/retail outlets. Cocobolo, lignum vitae, bocote, snakewood, pink ivory, ebony and more. Logs to lumber. SASE, Tropical Exotic Hardwoods of Latin America, Box 1806, Carlsbad, CA 92008. (619) 434-3030, FAX (619) 434-5423.

BAND SAWN HARDWOODS, kiln-dried walnut, oak, R/W quartered, bubinga 6/4 50-in. wide flitch sawn, zebrawood and old growth remanufactured long leaf yellow pine. Gary Mayse, 319 Richardson Rd., Lansdale, PA 19446. (215) 822-8307.

EAST MOUNTAIN HARDWOODS, Rte. 7, Box 31H, Sheffield, MA 01257. Select oak, cherry, maple, ash, butternut, walnut, mahogany, tulip, pine, plank flooring, butcher block, hardwood plywood, custom milling. Toll free: MASS., 1-800-551-5028; Northeast 1-800-521-2019.

STADTLANDER'S SAWMILL, 2881 Frost Rd., Mantua, OH 44255. Kiln-dried native hardwoods. (216) 274-2671.

HIGHLAND HARDWOODS, Hardwood Distribution Center, Route 125, Brentwood, NH. Kiln-dried red oak, cherry, maple, ash, butternut, walnut, poplar, birch, pine and hardwood plank flooring. PO Box 426, Kingston, NH 03848. (603) 679-1230.

CURLY, BIRD'S-EYE AND QUILTED MAPLE. 4/4 - 12/4. Also myrtle and cherry. Bill Largent, San Luis Obispo, CA (805) 544-9663.

HARDWOODS

Over 75 Species of Exotic & Domestic Lumber - Turning Blanks - Squares - Veneers.

COLLECTORS SAMPLE KIT: 36 Exotic & Domestic Woods 3/8 x 3 x 6 Sanded Finish \$29.00 Plus \$5.00 S & H

WOODWORKERS SUPPLY 5402 S. 40th St/Phoenix, AZ 85040
1-800-423-2450

GILMER WOOD CO. 503-274-1271

Rare & Exotic Woods

- in logs, planks & squares
- over 50 species in stock
- also cutlery, turning & musical instrument woods

2211 NW St. Helens Rd., Portland, OR 97210

QUARTERSAWN WHITE OAK AND FIGURED LUMBER

Curly, Bird's-eye, Quilted, Crotch

800-373-6097 or 215-775-0400

RD #3, Box 3268, Mohnton, PA 19540-9339

TALARICO HARDWOODS

HOMESTEAD HARDWOODS, 2111 Messick Rd., N. Bloomfield, OH 44450. (216) 899-3770. Kiln-dried ash, basswood, butternut, cherry, chestnut, curly maple, oak, poplar, sassafras, walnut.

BURLWOOD WOODWORKERS: quilted, curly, and bird's-eye maple. Redwood burls, slab turning stock, any size, thickness available. Albany, OR. (503) 926-1123.

TURNING BLOCKS, BURLS, AND CROTCHES—exotic and domestic hardwoods—write or call for price list. Wood-ply Lumber, 100 Bennington Ave., Dept. F, Freeport, NY 11520. (516) 378-2612.

WESTERN PENNSYLVANIA WOODWORKERS

50 Domestic & Imported Woods

Veneers • Finishes • Mouldings • Hardware
Carving Stock • Inlays & Bandings
Plans • Books • Magazines • Quality Tools

Call or Visit Our Store

WOODCRAFTERS' SUPPLY
7703 Perry Hwy. (Rt. 19)
Pittsburgh, Pa. 15237 (412) 367-4330

UNICORN UNIVERSAL WOODS Ltd

OVER 90 SPECIES IN OUR LARGE INVENTORY OF QUALITY MATERIAL

EXOTICS—DOMESTICS—MILLWORK

VENEER—MAIL ORDER—FREE CATALOG

4190 Steeles Ave. West, Woodbridge Ontario Canada L4L 3S8
CALL US AT (416) 851 2308

GROFF AND HEARNE LUMBER

Walnut—Cherry and other fine cabinet woods. Boards to 40", matching flitches, slab cuts, kiln dried. Days, nights, weekends, call: 717-284-0001, 215-274-8810, 717-548-3834.

Groff & Hearne Lumber
858 Scotland Road, Quarryville, PA 17566

FINE VENEER

Highest Quality Retail or Low Prices Wholesale

Full Length Veneers Area Code 716
Large Selection 655-0206
Exotic Lumber Call or Write
Custom for FREE
Plywoods Catalog

certainly wood

11753 Big Tree Rd., E. Aurora, N.Y. 14052
Fax. No. (716) 655-3446
Our wood certainly makes a difference.

Sandy Pond Hardwoods

TIGER and BIRD'S-EYE

Curly Ash, Curly Oak
Curly Cherry, Curly Birch

LUMBER AND FLOORING

921-A Lancaster Pike, Quarryville, PA 17566
(717) 284-5030

Flooring

Oak 21/4 strip No. 2 \$.75 BF

Heart Pine Cherry Walnut
Maple Hickory Pine

HARMONY EXCHANGE

Rt. 2 Box 843-W Boone, NC 28607 (704)-264-2314

Timbers Logs Stress-Skin Panels
Paneling Decking Siding

ATTENTION: FLORIDA WOODWORKERS

We have Florida's largest selection of exotic and native hard and soft woods, table slabs, veneers, etc. for the professional and novice. Send \$1.00 for list.

HENEGAN'S WOOD SHED

1760 Southern Blvd./FWI, West Palm Beach, FL 33411
Call (407) 753-1557

Fine Woods
RIVERSIDE LUMBER
 OVER 75 SPECIES IN STOCK
 5451 Morrison Rd.
 New Orleans, LA 70126
1-800-669-6624

WOOD & TOOL EXCHANGE

Limited to use by individuals only

For Sale

INCA #250, 10-in. table sawstand, mortise table, blade, 1 1/2 HP motor, tenon cutter, other accessories, \$950. (406) 862-9447.

FINE WOODWORKING complete set #1-79, excellent condition. \$225. plus UPS. Richard Zeller, 480 Royale Park Dr., San Jose, CA 95136.

FOR SALE. 5000 bf. good, dry redwood burl and curly slabs, \$1.50 bf. Also have thousands of top grade flawless slabs in all sizes for \$5-\$10 bf. (707) 442-0581.

24-in. FAY & EGHAN PLANNER 10HP, 3PH extra heavy duty. Works beautifully. Barry Roberts. (804) 294-5160.

BRAZILIAN ROSEWOOD. Boards and veneer, more purple than golden. Call for more information. (203) 355-0062.

BANDSAWS 20-in., 24-in., 30-in., 36-in.; 14-in. tablesaw. Widebelt sander. 1-in. and 1 1/2 spindle shaper. 7 1/2 and 10HP air compressors. 8-in., 12-in., 16-in. jointers. 16-in., and 24-in. planers. Buss 661, 40-in. planer and grinder, pinrouter/pattern vise. (412) 593-7038.

INCA 550, 10 1/4 jointer/thickness planer. Inca 259 10-in. cabinetmakers saw, mortise attachments and other accessories. Elektra dust collector. All in excellent condition, \$3800. (703) 326-2379.

SMALL PRIVATE SHOP selling out. Inca, Myford, Delta. Must buy all. Please call after 8 pm. (616) 832-5718.

SET OF FINE WOODWORKING, issues 1-67, very good condition. Also have every issue of WOOD. (518) 869-1278.

NEVER USED. Inca 3/4-in. shaper model #659 \$1100 or best offer, also; Freud EC260 & EC59 cutters. Gary (602) 526-4037, Arizona.

STANLEY NO. 55 in almost-new condition. Complete set of 52 cutters in original boxes, plus original product description. Dated 11/17/15. Best Offer. R. H. Kessler, 349 S. Washington, Dr., Sarasota, FL 34236.

PINK IVORY, AFRICAN BLACKWOOD, masur birch, etc. Logs. Fantastic size, color and figure. Call (203) 572-0099.

DELTA/ROCKWELL #46-450 older style HD VS lathe. Completely restored. 1PH, \$1450. FOB Calif. (714) 927-7126

Wanted to Buy

WANTED: Complete set of FINE WOODWORKING. Russ Anderson, days (503) 232-4154, eves (503) 653-8161. P.S.T.

WANTED: FINE WOODWORKING issue 17. Will buy full or broken set to obtain and sell excess. (415) 447-0596.

WANTED: complete set of FINE WOODWORKING, #1-70 or better. Willing to pay for freight. Ask for Stu. (818) 967-1342.

WALNUT FOR CARVING. Sculptor needs clear, straight grain minimum 4-in. thick, 12-in. wide. H. Intili, Box 224, Roswell, GA 30077. (404) 640-0514.

WANTED: FINE WOODWORKING, complete set. K. Mulla, 86 Cree Ave., Scarborough, Ont, Canada M1M 1Z8. (416) 266-8457.

OLD YATES-AMERICAN tilting arbor table saw with cast-iron frame in good condition. Tony Alexander, 46 Circle Dr., Charleston, IL 61920. (217) 345-5138.

WANTED: FINE WOODWORKING, issues 1 thru 20 to complete my collection. Call David. (716) 342-3756 eves.

Fine Woodworking

Attention Retailers

If you would like to carry *Fine Woodworking* in your store, just write or call 1-800-243-7252, and find out how easy it is to set up an account directly with us—no hassles, no risk, attractive terms.

The Taunton Press, Box 355, 63 S. Main St., Newtown, CT 06470

MOVING?

Don't miss an issue of *Fine Woodworking*. Just fill out and return this form at least six weeks before you move. Or call 1-800-243-7252 (in CT, 426-8171).

Old Address:
 Name _____
 Address _____
 City _____ State _____ Zip _____

New Address:
 Address _____
 City _____ State _____ Zip _____

The Taunton Press, 63 South Main Street, Newtown, CT 06470

INCREASE PRODUCTION & SAVE FINGERS with COMATIC POWER FEEDERS

SUNHILL introduces the new FD-308 Cabinet shop power feeder. The FD-308 utilizes a 1/2 HP motor and was designed to bridge the size and power gap between existing power feeder models.

INTRODUCTORY OFFER \$569.00

List price \$795.00



Motor	1/2 HP 1 or 3 Phase
Feed Speeds:	
1 Phase:	10/15/25/38 Ft/Min
3 Phase:	9.5/15/19/25/30 38/50/76 Ft/Min
Rollers (3)	4" Dia. x 2" Width
Weight	100 lbs.

For more information write

SUNHILL
 100 Andover Park East
 Seattle, WA 98188
 Or call toll free
 1-800-544-1361

TV LIFT CABINET PLANS AVAILABLE

CONCEAL REVEAL SWIVEL

AUTON POP UPS

YOU BUILD THE FURNITURE—WE'LL PROVIDE THE AUTOMATION

Radio Remote Controlled
 Auton revolutionary design utilizes a power motor encased in a 3" high lifting platform. It glides smoothly and quietly on four rack and pinions which totally eliminates wobble (makes the "old-style" scissor lift obsolete). Radio remote control (not infrared) has a range in excess of 100 feet.

Motorized Swivel
 An exciting option is our exclusive motorized swivel which allows the unit to turn 360° by remote control.

Wide range of sizes
 Custom systems available to 20 feet wide, 8 feet high and capacities to 2000 pounds.

Free Brochure Write for our brochure or call us today. Send \$10 for TV. Lift cabinet plans—will apply toward purchase.

AUTON COMPANY Box 1129 • Sun Valley, CA 91353-1129 • (213) 659-9533
 Telex 362238/FAX (818) 362-9215/W.U. EASYLINK 62004443
 Beverly Hills (213) 659-1718 • Honolulu (808) 734-1260.
 Worldwide service to the design community since 1955.
 Auton does not make furniture. U.S. & Foreign Pat Pend. MADE IN U.S.A.

Listings of gallery shows, major craft fairs, lectures, workshops and exhibitions are free, but restricted to happenings of direct interest to woodworkers. We list events (including entry deadlines for future juried shows) that are current with the time period indicated on the cover of the magazine, with overlap when space permits. We go to press three months before the issue date of the magazine and must be notified well in advance. For example, the deadline for events to be held in March or April is January 1; for July and August, it's May 1, and so on.

ALABAMA: Exhibit—Focus: Four Alabama Artists, thru Mar. 1. Birmingham Museum of Art, 2000 8th Ave. N., Birmingham 35203-2278. (205) 254-2566.

ALASKA: Juried exhibit—International Turned Objects Show, Jan. 6–Feb. 25. Anchorage Museum, Anchorage. Contact Sarah Tanguy, International Sculpture Center, 1050 Potomac St. N.W., Washington, DC 20007. (202) 965-6066.

ARIZONA: Exhibit—Woodturning Mastery, Mar. 1–31. The Hand and the Spirit Gallery, 4222 N. Marshall Way, Scottsdale, 85251. (602) 949-1262.

Seminars—Woodcarving seminars, Mar. 1–3, 5–7. Contact Dave Ruslo Woodcarvers Supply, 2530 N. 80th Pl., Scottsdale, 85257. (602) 994-1233.

Show—The Arizona Woodworking Show, Mar. 9–11. Veterans Memorial Coliseum, 1826 W. McDowell Rd., Phoenix, 85005. For more info., contact Michelle Troop, 1516 S. Pontius Ave., Los Angeles, CA 90025. (213) 477-8521.

CALIFORNIA: Workshops—Various workshops including Japanese woodworking, joinery and sharpening. Contact Hida Tool Co., 1333 San Pablo, Berkeley, 94702. (415) 524-3700.

Workshop—Design, Operation and Maintenance of Saws, Feb. 26–27. Wood Machining Institute, Box 476, Berkeley, 94701. (415) 943-5240.

Show—The Northern California Woodworking Show, Mar. 16–18. San Jose Civic Auditorium, 145 W. San Carlos St., San Jose, 95110. For info., contact Diane Johnson, 1516 S. Pontius Ave., Los Angeles, 90025. (213) 477-8521.

Festival—Contemporary Arts Festival, Mar. 23–25. Convention and Performing Arts Center, San Diego. Contact General Expositions, 111 Liberty St., Petaluma, 94952. (707) 778-6300.

Exhibit—Robert Bassler: Large Scale Sculpture, thru Mar. 25. Gallery at the Plaza, Security Pacific Corp., 333 S. Hope St., Los Angeles, 90071.

Festival—Contemporary Arts Festival, Mar. 30–Apr. 1. Brooks Hall Civic Center, San Francisco. Contact General Exposition, 111 Liberty St., Petaluma, 94952. (707) 778-6300.

Convention—Wood Machinery Manufacturers of America and Woodworking Machinery Distributors' Association joint industry convention, Apr. 21–25. Hotel Del Coronado, Coronado. For info., contact WMAA, 1900 Arch St., Philadelphia, PA 19103. (215) 564-3484.

Exhibit—"Hands On! Objects Crafted in our Time," thru May. Craft and Folk Art Museum, 5800 Wilshire Blvd., Los Angeles. (213) 937-5544.

Classes—Boatbuilding classes, May 5–6, May 12–13. National Maritime Museum Assoc., Bldg. 275, Crissy Field, San Francisco, 94129. For info., call (415) 929-0202.

Show—The Southern California Woodworking Show, May 11–13. Pasadena Center, 300 E. Green St., Pasadena, 91101. For info., contact Michelle Troop, 1516 S. Pontius Ave., Los Angeles, 90025. (213) 477-8521.

COLORADO: Show—The Colorado Woodworking Show, Mar. 2–4. National Western Complex, 1325 E. 46th Ave., Denver, 80216. Contact Diane Johnson, 1516 S. Pontius Ave., Los Angeles, 90025. (213) 477-8521.

Classes—Woodworking and related classes, year-round. Red Rocks Community College, 13300 W. 6th Ave., Lakewood, 80401. (303) 988-6160.

Workshops—One- and two-week workshops, June thru Aug. Registration until then. Anderson Ranch Arts Center, Box 5598, Snowmass Village, 81615. (303) 923-3181.

CONNECTICUT: Exhibit—In Sono: design furniture and accessories by Eric Bergman and Gordon Naylor, thru Mar. 4. In Brookfield: various woodworking workshops beginning Jan. 20, including carving techniques with Eugene Landon, Mar. 24–25 and woodturning with Dennis Elliott, Mar. 31–Apr. 3. Contact Brookfield Craft Center, Box 122, Route 25, Brookfield, 06804. (203) 775-4526.

Juried exhibit—Society of Connecticut Craftsmen annual exhibition, Mar. 11–Apr. 8. Mattatuck Museum, Waterbury. For info., contact SCC, Box 615, Hartford, 06142. (203) 267-8475.

Juried exhibit—33rd annual handcrafts exposition, July 19–21. Guilford Green. Deadline: Mar. 3. For info., contact Guilford Handcrafts, Box 589, 411 Church St., Guilford, 06437. (203) 453-5947.

DELAWARE: Exhibit—Furniture by Wendell Castle, Mar. 9–May 13. Delaware Art Museum. For info., contact Rochester Institute of Technology, 1 Lomb Memorial Dr., Box 9887, Rochester, NY 14623. (716) 475-5064.

Program—Grants-in-aid from the Early American Industries Assoc. to assist individuals with research and studies, including areas of woodworking. Application deadline for 1990 awards: Mar. 15. Contact Charles Hummel, Wintertur Museum, Wintertur, 19735.

DISTRICT OF COLUMBIA: Juried show—8th annual Washington Craft Show, Apr. 19–22. The Departmental Auditorium, 1301 Constitution Ave. N.W. For info., contact Smithsonian Associates Women's Committee, Arts and Industries Bldg., Room 1465, Smithsonian Institution, 20560. (202) 357-4000.

Exhibit—Tradition and Innovation: New American Furniture, Apr. 20–Sept. 3. Renwick Gallery, 17th St. & Pennsylvania Ave. N.W. For info., call (202) 357-2247.

Seminar—20th-Century Furniture: The Spirit of Design, Apr. 30–May 4. For info., contact MaryBeth Mullen, Smithsonian National Associate Program, 1100 Jefferson Dr. S.W. (202) 357-4700.

Exhibit—Culture and Commentary: An '80s Perspective, thru May 6. Hirshhorn Museum and Sculpture Garden, Smithsonian Institution, Independence Ave. at 8th St. S.W. Featuring works of 15 artists, including wood sculptor Jeff Koons. For info., call (202) 357-2700.

FLORIDA: Show—Woodworking World show, Feb. 23–25. Jacksonville Memorial Hall, Jacksonville. For info., contact WANA, Box 706, Plymouth, NH 03264. (800) 521-7623, in NH (603) 536-3768.

Festival—2nd annual Italian Street Festival, Apr. 5. Moroso Park. For info., contact the Italian Street Festival, Box 14157, N. Palm Beach, 33408-0157. (407) 844-8070.

Juried festival—21st annual spring arts festival, Apr. 7–8. Gainesville. Contact Spring Arts Festival, Box 1530, Gainesville, 32602. (904) 372-1976.

GEORGIA: Seminar—Manufacturing Solutions for the 1990s and Beyond, Mar. 21–23. Westin Lenox Hotel, Atlanta. Featuring wood manufacturing experts Howard Feldman, Gunter Geiger and Richard Godfrey. For info., contact the Italian Trade Commission, 1801 Ave. of the Stars, Suite 700, Los Angeles, CA 90067. (213) 879-0950.

Show—The Atlanta Woodworking Show, Mar. 23–25. Lakewood Fairgrounds, 2000 Lake Ave., Atlanta, 30315. Contact Michelle Troop, 1516 S. Pontius Ave., Los Angeles, CA 90025. (213) 477-8521.

Juried exhibition—International Woodworking Fair Design Competition, Aug. 24–27. Challengers Award competition deadline: June 1. Contact Shirley Byron, International Woodworking Machinery and Furniture Supply Fair, 8931 Shady Grove Court, Gaithersburg, MD 20877.

Workshops—Japanese woodworking by Toshilero Sahara. One Saturday each month, year-round. Contact Sahara Japanese Architectural Woodworks, 1716 Defoor Place N.W., Atlanta, 30018. (404) 355-1976.

IDAHO: Juried show—Art on the Green festival, Aug. 3–5. North Idaho College campus. Deadline: Apr. 13. Contact Carol Clark, Citizens Council for the Arts, Box 901, Coeur d'Alene, 83814. (208) 667-9346.

ILLINOIS: Seminars—Woodworking seminars, thru Mar. In the Chicago area. For info., contact Wood World, 1719 Chestnut Ave., Glenview, 60025. (708) 729-9663.

Show—The Chicagoland Woodworking Show, Apr. 20–22. Odeum, 1033 N. Villa Ave., Villa Park, 60181. Contact Diane Johnson, 1516 S. Pontius Ave., Los Angeles, CA 90025. (213) 477-8521.

INDIANA: Seminar—Wood Dust and its Control, Mar. 20. Holiday Inn, Elkhart. For info., contact Daniel Cassens, Dept. of Forestry & Natural Resources, Purdue University, West Lafayette, 47907. (317) 494-3644.

Workshops—Second Saturday woodworking workshops, thru Apr. Edward B. Mueller Co., 3940 S. Keystone, Indianapolis, 46227. (317) 783-2040.

IOWA: Juried fair—20th Art in the Park, May 19–20. Main Ave., Clinton. Entries deadline: Mar. 31. Contact Clinton Art Assoc., Box 132, Clinton, 52732. (319) 259-8308.

KANSAS: Juried show—Dimensions, 3-dimensional art show, June 8–10. Sar-Ko-Par Trails Park, Lenexa. Deadline: Mar. 31. For info., contact William Nicks, Jr., Dimensions, 13420 Oak St., Lenexa, 66215. (913) 541-8592.

Juried show—Topeka Competition 14, Apr. 1–26. For info., contact Gallery of Fine Arts, Topeka Public Library, 1515 W. 10th, Topeka, 66604. (913) 233-2040.

KENTUCKY: Seminar—Wood Veneering for Furniture, Panel and Cabinet Manufacturing, Mar. 5–7. Louisville. For info., contact Daniel Cassens, Dept. of Forestry & Natural Resources, Purdue University, West Lafayette, IN 47907. (317) 494-3644.

Workshop—Woodturning with Rude Osolnik and Todd Hoyer, Mar. 16–17. Civic Center, 410 W. Vine St., Lexington. Held in conjunction with the International Turned Objects Show, Mar. 10–May 6. Also at the Civic Center. For info., contact Kentucky Woodworkers Association, Box 22018, Lexington, 40522. (606) 252-3289.

LOUISIANA: Woodworking World show, Mar. 16–18. Riverside Centroplex, Baton Rouge. Contact WANA, Box 706, Plymouth, NH 03264. (800) 521-7623, in NH (603) 536-3768.

Juried show—Craftsmen's show, Apr. 9–May 4. Louisiana Crafts Council Gallery, Baton Rouge. Deadline: Mar. 28. Contact LA Crafts Council, Box 1287, Baton Rouge, 70821. (504) 383-1782.

MAINE: Classes—Design and build, Mar. 5–16, May 7–29; post and beam, Apr. 15–20. Contact Shelter Institute, 38 Centre St., Bath, 04530. (207) 442-7938.

Show—Woodworking World show, Apr. 27–29. Portland Expo Building, 239 Park Ave., Portland. For info., contact WANA, Box 706, Plymouth, NH 03264. (800) 521-7623, in NH (603) 536-3768.

MARYLAND: Fair—ACC Craft Fair, Mar. 2–4. Baltimore Convention Center. For info., contact American Craft Enterprises, Box 10, New Paltz, NY 12561. (914) 255-0039.

Juried fair—Sugarloaf's 15th annual spring arts & crafts fair, Apr. 20–22. Montgomery County Fairgrounds. Contact Deann Verdier, Sugarloaf Mountain Works, 20251 Century Blvd., Germantown, 20874. (301) 540-0900.

MASSACHUSETTS: Workshops—Various woodworking workshops in April. Contact Andover Historical Society, 97 Main St., Andover, 01810. (508) 475-2236.

Show—Lathe-turned furniture, thru Mar. 4. Ten Arrow Gallery. Contact Ten Arrow Gallery, 10 Arrow St., Cambridge, 02138. (617) 876-1117.

Show—New American Furniture, thru Mar. 11. Museum of Fine Arts, Boston.

Juried exhibits—Woodturners of the Northeast 1990, thru Mar. 17. Annual May craft fair, May 18–20. Contact Worcester Center for Crafts, 25 Sagamore Rd., Worcester, 01605. (508) 753-8183.

Shows—Boston Gift show, Mar. 24–28. Bayside Exposition Center; American & International Craft show, Mar. 24–27. World Trade Center. Contact George Little Management, 2 Park Ave., Suite 1100, New York, NY 10016. (212) 686-6070.

Workshop—Design and Construction with Bent Wood and Wood Forming, Apr. 7–8. Worcester. With Canadian furniture designer Michael Fortune. Contact the Worcester Center for Crafts, 25 Sagamore Rd., Worcester, 01605. (508) 753-8183.

Workshop—Cabinetmaking, Apr. 23–27. Washington. Contact Will Beemer, Heartwood, Johnson Hill Rd., Washington, 01235. (413) 623-6677.

Workshops—One- or two-day workshops including bandbox making and making hand tools, thru June. Old Sturbridge Village, 1 Old Sturbridge Village Rd., Sturbridge, 01566. (508) 347-3362.

MICHIGAN: Show—American Craft Expo '90, Apr. 4–8. Minneapolis Convention Center. For info., contact American Craft Enterprises, Box 10, New Paltz, NY 12561.

MONTANA: Juried show—The Good Wood show, Mar. 16–18. The Metra on the fairgrounds, Billings. Contact Bob Lund, Montana Woodcarvers Assoc., 2039 Walter Rd., Billings, 59105. (406) 248-5373.

NEBRASKA: Show—Nebraska Woodworking Show, May 4–6. Aksarben Field, 63rd & Shirley Streets, Omaha, 68106. Contact: Diane Johnson, 1516 S. Pontius Ave., Los Angeles, CA 90025. (213) 477-8521.

NEW HAMPSHIRE: Classes—Classes in fine arts and studio arts, beginning Jan. 15. Manchester Institute of Arts and Sciences, 114 Concord St., Manchester, 03104.

Retreat—Woodworking retreat, July 22–26. Waterville Valley Resort & Conference Center, White Mountain National Forest. Contact WANA, Box 706, Plymouth, 03264. (800) 521-7623.

NEW JERSEY: Shows—Super Crafts Star Show, Mar. 9–11. Meadowlands Stadium, East Rutherford. Super Crafts, Mar. 30–Apr. 1. Garden State Convention & Exhibit Center, Somerset. Contact Creative Faires, Box 1688, Westhampton Beach, NY 11978. (516) 288-2004.

NEW MEXICO: Classes—Building the Norwegian Pram, Apr. 14–15, Apr. 21–22. Sponsored by Albuquerque Woodworkers Association. Contact Jim Linke, 1414 Silver St., Albuquerque, 87106. (505) 243-7234.

NEW YORK: Classes—Woodworking classes at all levels. Contact The Craft Students League, 610 Lexington Ave. at 53rd St., New York, 10022. (212) 735-9732.

Juried exhibit—Northeast fine crafts exhibit, Mar. 11–May 31. Schenectady Museum & Planetarium. Entries deadline: Feb. 26. Contact Marlene Scholl, Nott Terrace Heights, Schenectady, 12308. (518) 399-8381.

Exhibit—Crossing Boundaries, opening Mar. 14. New York City. Featuring five artists, including David Ellsworth. Bellas Artes Gallery, 584 Broadway, New York City. Call (505) 983-2745 for info.

Lecture—Furniture Finishing and Restoration by Homer Formby, Mar. 16. Strong Museum, Rochester. Sponsored by the Rochester Woodworkers Society. For info., contact Jim Hotaling, Rochester Woodworkers Society, Box 67054, Rochester, 14617. (716) 223-4877.

Workshops—Hand tool workshops with Robert Meadows, Mar. 17–18, Apr. 21–22. The Lutherie, 2449 W. Saugerties Rd., Saugerties, 12477. (914) 246-5207.

Show—Woodworking World show, Apr. 6–8. Erie County Fairgrounds, 5600 McKinley Parkway, Hamburg. Contact



WHOLE EARTH ACCESS

CALL TOLL FREE (800)829-6300 FREE 7 DAYS A WEEK

FREIGHT ON ALL PORTABLE TOOLS IN CONTINENTAL US *FOB BERKELEY

PORTER+CABLE
SAW BOSS
 6" Circular Saw
 Model 345 **99.**



Milwaukee
 3/8" VSR Drill
 Model 0222-1 **99.**



SPECIAL PURCHASES PORTER+CABLE NEW

Makita
 VS Cordless Driver/Drill w/ Clutch Kit
 Model 6093DW **129.**



BOSCH
 Var. Speed Var. Orbit Jigsaw
 Model 1581VS **129.**



- 621 3/8" VSR Drill 94.
- 7511 3/8" VSR Drill 108.
- 7514 1/2" VSR drill 117.
- 666 3/8" T-Handle drill 120.
- 7556 2-Spd. rt. angle drill 175.
- 303 Pro 7" paint remover 149.
- 304 Pro 7" disc sander 125.
- 305 Pro 7" disc polisher 125.
- 320 Abrasive plane 95.
- 367 3/4" plane 145.
- 9118 Porta-plane kit 209.
- 9652 Versa-plane kit 270.
- 7310 Laminate trimmer 95.
- 7312 Offset base lam. trimmer 124.
- 7319 Tilt base lam. trimmer 109.
- 7399 Drywall cutout unit 78.
- 100 7/8 HP router 95.
- 518 3 HP microproccsr, 5spd. 330.
- 536 1/2 HP speedmatic 195.
- 537 1/2 HP spdmatc, d-handle 209.
- 630 1 HP router 109.
- 690 1/2 HP router 119.

- 0239-1 1/2" drill, keyless chuck 129.
- 0224-1 3/8" Magnum holeshooter 109.
- 0234-1 1/2" Magnum holeshooter 115.
- 0375-1 3/8" close-quarter drill 129.
- 0379-1 1/2" close-quarter drill 149.
- 1676-1 Hole-hawg kit 230.
- 3002-1 Electricians rt. ang. drill kit 179.
- 3102-1 Plumbers rt. ang. drill kit 185.
- 5397-1 3/8" VS hammer drill kit 145.
- 8975 Heat gun 57.
- 5680 2 hp router 219.
- 5925 3"x24" dustless belt sander 219.
- 5936 4"x24" dustless belt sander 225.
- 6012 1/3 Sheet pad sander 105.
- 6014 1/2 Sheet pad sander 113.
- 6215 16" Electric chainsaw 185.
- 6226 2 speed bandsaw w/case 249.
- 6246 Single speed jigsaw 125.
- 6256 Variable speed jigsaw 140.

Tiger Cub All Purpose Saw Kit
 No. 9647 **119.**



12 V. Magnequench VSR Cordless Driver Drill Kit
 No. 9850 **135.**



6302 1/2" Drill 119.

6012HOW 2-Spd. cordless driver/drill kit 119.

6510LVR 3/8" Drill, heavy duty 79.

9207SPC 7" Electronic sander/polisher 145.

3612BR 1/2", 3HP Plunge router 187.

7 1/4" Framers Saw w/hypoid gears
 Model 5077B **139.**



2708 8" Table saw/carbide blade 259.

9401 4"x24" Dustless belt sander 165.

9900B 3"x21" Dustless belt sander 145.

LS1020 10" Miter saw 249.

- 1582VS VS, Var orbit jigsaw 123.
- 3238VS VS, Var. orbit std. duty jigsaw 95.
- 1654 7/4" Builders circular saw 99.
- 1500 16 gauge shears 205.
- 1942 Heavy duty heat gun 69.
- 3268 Std. duty heat gun 65.
- 3258 3/4" Power plane 129.
- 1600 2 1/2 HP, D-Handle router 245.
- 1604 1 3/4 HP Router 119.
- 1606 1 3/4 HP, D-Handle router 140.
- 90300 3 1/4 HP Production router 329.
- 1609K Laminate trimmer installer's kit 169.
- 1609 Off set base laminate trimmer 119.
- 9164VSR 3/8" Mighty Midget VSR drill 99.
- 1631K 2-spd Panther reciprocating saw 119.

Speed-Bloc Finishing Sander
 Model 330 **57.**



2 Speed Sawzall
 Model 6511 **119.**



DELTA
8 1/4" Bench Saw
 Model 34-330 **199.**



ELU BLACK & DECKER
1 HP Plunge Router
 Model 3303 **159.**



3 HP Plunge Router
 Model 1611 **198.**



- 691 1/2 HP router, d-handle 130.
- 555 NEW! plate joining machine 165.
- 505 1/2 Sheet pad sander 112.
- 352 3"x21" dustless belt sander 125.
- 360 3"x24" dustless belt sander 175.
- 362 4"x24" dustless belt sander 185.
- 503 3"x24" wormdrive belt sander with bag 349.
- 314 4 1/2" Trim saw 125.
- 315-1 7 1/4" Top handle saw 112.
- 548 Heavy duty bayonet saw 165.
- 7548 VS, var. orbit, d-handle jigsaw 125.
- 7648 VS, var. orbit jigsaw 125.
- 9627 2-Spd. Tiger saw w/case 125.
- 9629 Var. spd Tiger saw w/case 135.
- 7523 Pos. clutch screwdriver 139.
- 7542 TEKS Driver 119.
- 7545 VSR Drywall driver 109.

HITACHI
1/2" Plunge Router
 Model TR12 **169.**



BOSTITCH
Finish Nailer
 N60FN **339.**



3304 1hp electronic plunge router 189.

4023 3x21 belt sander 195.

Call for Elu products not listed

7 1/4" Super Saw Cat
 Model 3047-09 **165.**



- 1608T NEW! tilt base laminate trimmer 99.
- 1632VSK VS, Var. orbit Panther reciprocating saw 134.
- 1530 14 gauge nibbler 269.
- 9166VSR 1/2" Mighty Midget VSR drill 109.
- 1158VSR 3/8" VSR drill 59.
- 1196VSR 3/8" Hornet II hammer drill 109.
- 1198VSR 1/2" VSR hammer drill 129.
- 11203 1 1/2" Rotary hammer 409.
- 11212VSR 3/4" VSR bulldog SDS rotary hammer 185.
- 11304 Brute breaker hammer 1299.*
- 11305 Demolition hammer 659.
- 1272D 3"x24" dustless belt sander 175.
- 1273D 4"x24" dustless belt sander 179.
- 1273DVS 4"x24" VS, dustless belt sander 189.
- 3270 3"x21" dustless belt sander 129.
- 1347A 4 1/2" mini grinder, 5/8" arbor 85.

12 V. VSR Cordless Drill Kit
 Model 2735:04 **135.**



NEW! 8 1/2" Compound Miter Saw
 Model C8FB **499.**
 FREIGHT INCLUDED



EMGLO
3/4 HP Twin Tank Hand-Carry Air Compressor
 Model AM39-HC4 **275.**



Drywall AEG Screwdriver
 0-4000 rpm
 Model SCR2E-2 **95.**



DELTA
10" Unisaw 1 1/2 HP
 34-761 **1189.***



- 77 7 1/4" worm drive saw 139.
- 5825 6 1/2" Worm drive saw 145.
- 5510 5 1/2" Trim saw 95.
- 5790 10 1/4" Circular saw 259.
- 5865 8 1/4" Worm drive circular saw 159.

RYOBI
10" Portable Planer
 Model AP10 **355.**
 FREIGHT INCLUDED



DAVID WHITE INSTRUMENTS
Sight Level Package
 LP6-20 Includes instruments & tripod **229.**



NORTON
Multi-Oilstone
 Model 85960-9 **99.**



- 32-100 NEW! Stationary Plate Joiner 445.*
- 34-782 10" Unisaw, w/unifence 3 HP 1569.*
- 34-783 10" Unisaw, w/unifence 3PH1569.*
- 43-375 2 Spd. wood shaper 1489.*
- 33-150 Sawbuck 509.
- 33 050 Sawbuck II 549.
- 33-990 10" Radial arm saw 485.*
- 11-950 8" bench drill press 125.*
- 17-900 16.5" Drill press 329.*
- 28-283 14" Wood band saw w/3/4HP motor encl. steel std 625.*

- FREUD**
- LM72M008 8"x24T Rip 32.
 - LM72M010 10"x24T Rip 37.
 - LU73M010 10"x60T ATB 43.
 - LU81M010 10"x40T thin kerf 42.
 - LU82M010 10"x60T TCG 47.
 - LU84M008 8"x40T combination 39.
 - LU84M011 10"x40T combination 39.
 - LU85M008 8"x64T ATB fine cut-off 49.
 - LU85M010 10"x60T ATB fine cut-off 59.
 - LU85M014 14"x108T ATB fine cut-off 109.
 - LU85M015 15"x108T ATB fine cut-off 109.
 - LU87M010 10"x24T thin kerf 39.
 - LU88M010 10"x60T thin kerf 49.
 - LU91M008 8 1/2"x48T ATB miter saw blade 39.
 - LU98M010 10"x60T TCG 75.
 - PS203 7 1/4"x24T gen. purpose 17.
 - PS303 7 1/4"x40T fine cut 24.
 - SD308 8" Dado set 115.
 - EB100 Edge bander 269.
 - EC900 5 pc. shaper cutter set 279.
 - 88-100 9 pc. router bit set 99.
 - 90-100 15 pc. router bit set 169.
 - FB-107 7 pc. forstner bit set 49.

- C10FA Deluxe 10" miter saw 289.
- C15FB Deluxe 15" miter saw 389.*
- F1000A 12" Planer/6" jointer combo 1485.*
- CB75F Band saw 1575.*
- R100Y Dust collector 559.*
- P100F 12" Planer 1059.*
- RA200 8" portable radial arm saw 249.
- L120UK 3-5/8" Planer kit 99.
- R500 2 1/4" HP plunge router 159.
- R150K 1 HP plunge router kit 99.
- TR30U Laminate trimmer 79.
- B7075K 3"x21" Belt sander kit 119.
- S500A Finishing sander, 1/6 sheet 36.
- TS251U 10" Miter saw 185.
- TS380 14" Miter saw 345.
- RE600 3 HP Electronic VS Plunge Router 195.
- JP155 6 1/8" VS Joint Planer 330.

ADJUSTABLE CLAMP COMPANY

#50 'PONY' clamp fixture	EA. BOX/12	7.50	80.00
#52 'PONY' clamp fixture	EA. BOX/6	6.00	65.00
3/0 6" JORGENSEN h/screw	EA. BOX/12	8.35	47.60
2/0 7" JORGENSEN h/screw	EA. BOX/12	8.95	51.00
#0 8" JORGENSEN h/screw	EA. BOX/12	9.95	58.70
#1 10" JORGENSEN h/screw	EA. BOX/12	11.40	64.95
#2 12" JORGENSEN h/screw	EA. BOX/12	13.00	74.00
3712 12" Steel bar clamp		5.95	32.50
3724 24" Steel bar clamp		7.35	40.00

- 10" Contractors Saw w/30" Unifence**
 Model 34-445 (table optional) **769.**
- 
- 28-245 14" Wood bandsaw w/std., 1/2hp motor 465.*
 - 34-444 10" Contractors saw, 1 1/2hp 599.*
 - 22-661 NEW! DC-33 13" Planer 999.*
 - 37-154 6" long-bed jointer w/electricals 929.*
 - 37-350 8" long-bed jointer w/electricals 1290.*
 - 31-730 6" Belt, 12" disc w/electricals 969.*
 - 34-985 Production stock feeder 575.*
- CALL FOR QUOTES ON MACHINES NOT LISTED**
- CAMELLO**
- Junior Std. hand joining machine CALL
 - Top Deluxe hand joining machine CALL
 - Standard NEW, hand joining machine CALL
 - Plates # 0, #10, #20, 1000/box 29.

PRICES EFFECTIVE FOR MAIL & PHONE ORDERS ONLY. 822 ANTHONY ST., BERKELEY, CA. 94710 ERRORS SUBJECT TO CORRECTION.

WANA, Box 706, Plymouth, NH 03264. (800) 521-7623, in NH (603) 536-3768.

Festival—6th annual Spring Fling festival, Apr. 6-8. Nassau Coliseum, Uniondale. Contact Creative Faires, Box 1688, Westhampton, 11978. (516) 288-2004.

Exhibit—Discoveries in Folk Sculpture, thru Apr. 15. Museum of American Folk Art, Lincoln Square, Columbus Ave. and 66th St., New York, 10023. (212) 595-9533.

NORTH CAROLINA: Seminars—Getting the most out of Computerized Carriage Networks, Mar. 8-9; Improving Management Performance Through Better Communication, Mar. 27-29. Both in Raleigh. For info., contact NC State University, Box 8003, Raleigh, 27695. (919) 737-3386.

Exhibit—American Wildfowl Decoys, Mar. 18-May 12. Folk Art Center, Asheville. Contact Museum of American Folk Art, Lincoln Square, Columbus Ave. and 66th St., New York, NY 10023. (212) 595-9533.

Juried exhibit—Pride of North Carolina arts & crafts show, Mar. 30-Apr. 1. Raleigh Civic Center. Contact Gail Gomez, High Country Crafters, 46 Haywood St., Asheville, 28801. (704) 254-7547.

OHIO: Symposium—North Coast Woodturners 2nd annual symposium, Mar. 29-31. Coventry High School, 3257 Cormany Rd., Akron, 44319. Featuring turners Al Stirt, Russ Hurt, Clede Christiansen. For info., contact Dave Hout, 4124 Lake Vista Blvd., Akron, 44319. (216) 644-2232.

Show—Greater Cleveland Woodworking Show, Apr. 6-8. I-X Expo Center, 6200 Riverside Dr., Cleveland, 44135. For info., contact Michelle Troop, 1516 S. Pontius Ave., Los Angeles, CA 90025. (213) 477-8521.

OKLAHOMA: Show—Woodworking World Show, Mar. 9-11. Myriad Exhibition Hall, Oklahoma City. Contact WANA, Box 706, Plymouth, NH 03264. (800) 521-7623, in NH (603) 536-3768.

Seminars—Between Center Turning, Mar. 10. Bowl Turning, Mar. 17. Francis Tuttle Vo-Tech Center, 12777 N. Rockwell, Oklahoma City, 73142. (405) 722-7799.

Festival—24th annual Festival of the Arts, Apr. 24-29. Festival Plaza and Myriad Gardens, Oklahoma City. For info., contact Arts Council of Oklahoma City, 400 W. California, Oklahoma City, 73102. (405) 236-1426.

OREGON: Classes—Basic through advanced woodworking classes, beginning Jan. 8. Portland. Including bent lamination and woodcarving. Certificate program and part-time training in woodworking available. Contact

the Oregon School of Arts and Crafts, 8245 S.W. Barnes Rd., Portland, 97225. (503) 297-5544.

Juried show—Artquake, Sept. 1-3. Streets of downtown Portland. Deadline: Apr. 1. For info., contact Catherine Wygant, 7017 SE 8th Ave., Portland, 97266. (503) 774-0919.

Competition—Table, Lamp & Chair Design regional competition, Apr. 29-May 12. Deadline for entries: Apr. 6. Design workshops in conjunction with show, May 5-6. Contact Lynda Anderson, 2701 N.W. Vaughn St., Suite 608D, Portland, 97201. (503) 224-9178.

PENNSYLVANIA: Workshops—Various woodworking workshops, beginning Feb. 24. Including authentic Shaker oval box and carrier seminar, building a Windsor setee, Shaker furniture. Olde Mill Cabinet Shoppe, 1660 Camp Betty Washington Rd., York, 17402. (717) 755-8884.

Workshop—Hardwood lumber grading and inspection workshop, thru Mar. 2. Contact Agricultural Conference Coordinator, 306 Agricultural Administration Building, University Park, 16802. (814) 865-8301.

Exhibition—5th annual Northeast Wood Product Expo, Mar. 17-19. Hershey Lodge and Convention Center, Hershey. Contact NEWPEX '90, Dame Associates, 51 Church St., Boston, MA 02116. (617) 482-3596.

Exhibition—Lathe-Turned Objects: Trends, Transitions, Tradition, Apr. 13-17. Woodmere Art Museum, Chestnut Hill. Featuring objects made between 1700 and 1990. For info., call Woodmere Art Museum: (215) 247-0476.

Fair—Spring Pennsylvania Crafts Fair, Apr. 29. Featuring the Pennsylvania Craft Guild. Brandywine River Museum, Box 141, Chadds Ford, 19317. (215) 388-7601.

Juried show—Studio Days '90, Sept. 21-30. Open to DE, DC, MD, NJ, PA, VA, WV. Entries deadline: Apr. 30. Contact Chester Spring Studio, Chester Springs. (215) 827-7277.

Competition—Fish Images: A competition, May 5-June 10. Luckenbach Mill Gallery, 459 Old York Rd., Bethlehem, 18018. (215) 691-0603.

SOUTH CAROLINA: Juried show—13th annual Piccolo Spoleto Crafts Fair, June 1-3. Gaillard Auditorium, Charleston. Deadline: Mar. 3. Contact South Carolina Crafts Association, 1314 Lincoln St., Suite 308, Columbia, 29202. (803) 779-8200.

TENNESSEE: Juried exhibit—From Here to There: Vehicles for New Forms/New Functions, Feb. 24-May 19. Arrowmont School of Arts and Crafts, Box 567, Gatlinburg, 37738. (615) 436-5860.

Workshops—Various workshops including woodturning,

coopering, bowl and plate turning. Beginning Mar. 5. Contact Arrowmont School of Arts and Crafts, Box 567, Gatlinburg, 37738. (615) 436-5860.

TEXAS: Show—Woodworking World show, Mar. 2-4. Pasadena. Contact WANA, Box 706, Plymouth, NH 03264. (800) 521-7623, in NH (603) 536-3768.

Juried exhibit—15th annual Texas Crafts Exhibition, Apr. 7-8. Austin Winedale Historical Center. Contact the University of Texas at Austin, Box 11, Round Top, 78954. (409) 278-3530.

UTAH: Show—Utah Woodworking show, Apr. 27-29. Salt Palace, 100 S.W. Temple St., Salt Lake City, 84101. Contact Michelle Troop, 1516 S. Pontius Ave., Los Angeles, CA 90025. (213) 477-8521.

VIRGINIA: Show—Metro-Richmond Woodworking show, Mar. 30-Apr. 1. Richmond Centre, 400 E. Marshall St., Richmond, 23219. Contact Diane Johnson, 1516 S. Pontius Ave., Los Angeles, CA 90025. (213) 477-8521.

WASHINGTON: Classes—Boatbuilding classes, beginning Mar. 7. Northwest School of Wooden Boatbuilding, 251 Otto St., Port Townsend, 98368. (206) 385-4948.

Classes—Various boatbuilding classes, beginning Mar. 17-25. Center for Wooden Boats, 1010 Valley St., Seattle, 98109. (206) 382-2628.

WEST VIRGINIA: Class—Chip Carving, Apr. 23-29. Augusta Heritage Center, Davis & Elkins College, Elkins, 26241. (304) 636-1903.

WISCONSIN: Exhibition—Reseated, Mar. 4-May 13. Featuring works that use the chair as medium, subject matter and/or object. Contact Reseated, Exhibitions Dept., JMKAC, Box 489, Sheboygan, 53082. (414) 458-6144.

Juried show—18th annual Festival of the Arts, Apr. 8. Stevens Point. Contact Brenda Gingles, Festival of the Arts, Box 872, Stevens Point, 54481. (715) 341-7543.

CANADA: Meetings—Canadian Woodturners Assoc. meetings, throughout the year. Second Tuesday of each month. Contact Bob Stone, Box 8812, Ottawa, Ont., K1G 3J1. (613) 824-2378.

ENGLAND: Exhibit—Touring craft exhibit, featuring woodworking, thru Mar. 25. Crafts Council Gallery, 12 Waterloo Pl., London, SW1Y 4AU. 01-930-4811.

DO YOU WANT TO BE A BETTER WOODWORKER?

DON'T MISS

WOODWORKING WORLD SHOWS

THE HOUSTON SHOW
March 2-4, 1990
Pasadena Convention Center, Pasadena, TX

THE OKLAHOMA SHOW
March 9-11, 1990
Myriad Exhibition Hall, Oklahoma City, OK

THE BATON ROUGE SHOW
March 16-18, 1990
Riverside Centroplex, Baton Rouge, LA

THE BUFFALO SHOW
April 6-8, 1990
Erie County Fairgrounds, Hamburg, NY

THE PORTLAND SHOW
April 27-29
Portland Expo Center, Portland, ME

SEE THE LATEST MACHINERY, TOOLS & SUPPLIES
Fabulous Discounts on Hundreds of Products
Increase Your Knowledge at Free Seminars

SHOW HOURS:
Fri. 5pm-9pm / Sat. 10am-6pm / Sun. 10am-5pm

For More Information Contact WANA
P.O. Box 706, Plymouth, NH 03264
800-521-7623, M-TH

INTERNATIONAL TOOL CORPORATION
1939 TYLER STREET, HOLLYWOOD, FL 33020

1-800-338-3384 FAX US YOUR ORDER
(IN FLA 1-800-221-6767) 1-305-927-0291

OPEN MON-FRI, 7 AM TO 4 PM EST

VISA & MASTERCARD ACCEPTED
COD ADD \$3.00

<p>PORTER-CABLE</p> <p>6931 PLUNGE ROUTER BASE \$76</p> <p>100 7/8 HP ROUTER \$ 95 314 4 1/2" TRIM SAW 129 330 SPEED-BLOCK FIN. SANDER 54 845 SAM B055 6" CIRCULAR SAW 99 351 3x21 BELT SANDER 128 361 3x34 BELT SANDER 167 363 4x24 BELT SANDER W/D BAG 179 504 3x24 BELT SANDER XHD 329 505 1/2 SHEET FIN. SANDER 105 520 3 HP ROUTER 314 621 3/8" VSR DRILL 99 5116 OMNIGIG 268 7310 5.6 AMP LAMINATE TRIMMER 85 7334 RANDOM ORBIT FIN. SANDER 123 9118 PORTA-PLANE KIT 185 9629 VAR. SPEED TIGER SAW KIT 140 9647 TIGER CUT RECIP. SAW 116 9850 12V CORDLESS DRILL KIT 136 97310 LAMINATE TRIMMER KIT 190</p>	<p>BOSTITCH</p> <p>N80S-1</p> <p>Light-weight sack nailer combines speed and versatility for framing, decking and sheathing. Drives nails 2" to 3 1/2" long and up to 75 psi load. Angled magazine design for high nail capacity with unsurpassed operator visibility and maneuverability.</p> <p>\$407</p> <p>N50FN FINISH NAILER 1 1/2" CAP 324 N60FN FINISH NAILER 1 1/4" 1/2 3/32 336-50 STAPLER 16 GAUGE 1/2" CRN. 305 M111-812 T-NAILER 9/16-2 1/4" 429 M111-886 CORRUGATED STAPLER 379 T29-30 BRAD TACKLER 5/8-1 3/16" 299 T28-5 FINISH STAPLER 1 3/16" CAP 299</p>	<p>BOSCH</p> <p>1651 OR 1654 7 1/4" BUILDERS CIRCULAR SAW \$97</p> <p>1158VSR 3/8" VSR DRILL \$ 58 1272 3x24 BELT SANDER 165 1273 4x24 BELT SANDER 175 1273DVS 4x24 VS BELT SANDER W/BAG 189 1347A 4 1/2" MINI GRINDER 99 158DVS VS VAR. ORBIT JIG SAW 99 1601 1 HP ROUTER 95 1604 1 3/4 HP ROUTER 119 1609X TRIMMER INSTALLERS KIT 162 1611 3 HP PLUNGE ROUTER 209 1922K ORB. CORDLESS JIG SAW KIT 150 2258 3 1/4" PLANNER 139</p>
<p>Milwaukee</p> <p>6246 JIG SAW \$115</p> <p>0212-1 9.6V CORDLESS VSR DRILL 155 0228-1 3/8" VSR PISTOL DRILL 97 0382-1 7.2V CORDLESS DRILL KIT 185 5925 3x24 BELT SANDER W/BAG 218 5931 4x24 BELT SANDER W/O BAG 215 5936 4x24 BELT SANDER W/BAG 222 6014 1/2 SHEET FIN. SANDER 108 6140 4 1/2" ANGLE GRINDER 91 6365 7 1/4" CIRCULAR SAW 108 6511 2 SPEED SANZALL W/CASE 118</p>	<p>freud</p> <p>JS100 BISCUIT JOINING MACHINE \$153</p> <p>LU72M010 10"x40T ATB CARBIDE 36 LU82M010 10"x60T TC CUT OFF CARB. 48 LU84M008 8"x40T ATB COMBO CARBIDE 38 LU84M011 10"x50T ATB COMBO CARBIDE 41 LU85M010 10"x60T THIN KERF CROSSCT 46 LU85M014 14"x108T ATB CUTOFF CARB. 64 LU72M010 10"x24T ATB RIPPING CARB. 37 LU73M010 10"x60T ATB CUT OFF CARB. 43 LU87M010 10"x24T THIN KERF RIP 41 LU88M010 10"x60T THIN KERF CROSSCT 46 LU89M010 10"x72T TC NON FERROUS 64 PS203 7 1/4"x24T ATB CARBIDE 19 PS303 7 1/4"x40T ATB CUTOFF 23 DS308 8"x18T DADO SET CARBIDE 107 WC104 4 PIECE CHISEL SET 44 EB100 EDGE BANDING SYSTEM 270 FB-107 7 PC FORSTNER BIT SET 49 FB-100 16PC FORSTNER BIT SET 169</p>	<p>HITACHI</p> <p>C8FB 8" COMPOUND MITER SAW \$475.00</p> <p>TRB 1 1/2 HP PLUNGE ROUTER 117 F20A 3 1/4" PLANNER 95 SB-75 3x21 BELT SANDER W/BAG 129 SB8T 3x24 BELT SANDER W/BAG 139 SV212SA 1/4 SHEET FIN. SANDER 48 D7C10 7.2V 2 SPEED CORDLESS DRILL 79 DR100 SAME AS ABOVE BUT W/CLUTCH 85 DV10D CORDLESS HAMMER DRILL 119 D10VC 3/8" VSR DRILL 69 C75A 7 1/4" CIRCULAR SAW 69</p>
<p>DELTA</p> <p>40-150 15" SCROLL SAW \$125</p> <p>31-460 4" BELT 6" DISC SANDER 135 32-100 PLATE JOINER 445 36-040 8 1/4" COMPOUND MITER 150 31-050 1" BELT SANDER 59 36-510 10" TABLE SAW 179</p>	<p>RYOBI</p> <p>POWER TOOLS</p> <p>R-600 3 HP PLUNGE ROUTER \$179</p> <p>TS25IU 10" MITER SAW 189 TS380 14" MITER SAW 349 BT2500 10" TABLE SAW 279 GL155C 4 1/2" ANGLE GRINDER 59</p>	<p>FREE FREIGHT & SAME DAY SHIPPING ON MOST ORDERS</p>

QUANTITIES LIMITED
PRICES SUBJECT TO CHANGE WITHOUT NOTICE

Everybody talks
about the weather.
Now you can do
something about it.



1988 was one of the warmest years on record and global temperatures continue to rise. But instead of just talking about this environmental crisis, you can actually do something about it.

Join other Americans across the country in planting trees. You'll be shading your community and reducing heat-trapping CO₂ build-up in the earth's atmosphere.

For more information on how you can help, write Global ReLeaf, American Forestry Association, P.O. Box 2000, Dept. GR2, Washington, DC 20013.



You can make a world of difference.

READER SERVICE NO. 81

**Free
Catalog
Subscriptions**

**Woodworkers!
Carvers!**

**Call for
yours today!**

2 new, full-color catalogs are here for your browsing pleasure. Woodcraft's Fall Woodworking Catalog and Carving Catalog are packed with over 4,000 new and best-selling tools, supplies, kits & books. Ask for one or both!

Woodworking
Catalog



**Our advice
is free, too!**

Wondering what basic woodturning tools you need? How to get started in wood carving? Need help with a project? Our friendly, expert technical reps are just a free phone call away. Call them today! It's all part of the service you can expect from Woodcraft.

Carving
Catalog



Call free 1-800-225-1153

Or write to:



WOODCRAFT

Dept FW30, Wood County Park #210
P.O. Box 1686, Parkersburg, WV 26101

READER SERVICE NO. 71

**RIPSTRATE®
SAVES
FINGERS**

**AND MAKES STRAIGHTER CUTS
KEEPS HANDS AWAY FROM BLADE
NO KICKBACKS
SELF ADJUSTING
COMPLETE - NO EXTRAS TO BUY
RIGID CAST IRON FRAME**

Used by thousands of amateurs, professionals, schools, corporations, government agencies, and military installations.

ONE YEAR GUARANTEE. 30 DAY MONEY BACK TRIAL.
ONLY \$69 DELIVERED. CHECK, M.O., VISA OR M/C.
FREE BROCHURE.

WRITE OR CALL TOLL FREE 1-800 421 0256
Fisher Hill Products Inc 1 Fisher Hill
Fitzwilliam NH 03447



READER SERVICE NO. 29

Router Projects for the Woodworker by Brian J. Davies. *Stobart & Son Ltd., 6773 Worship St., London EC2A 2EL, England; 1988. paperback; 173 pp.*

In *Router Projects for the Woodworker*, a project is the subject of each chapter. Each project does employ the router to some extent. There are examples of template work, piloted trimming, circle cutting, lettering, overhead routing, table cutting, splining, boring, complementary routing and making a router table.

The examples in the book are unusual and sometimes involve very sophisticated woodworking, (i.e. triple miters, half-lap lattice, complementary template work, etc.). However, little attention is paid to router safety and some of the operations are dangerous (i.e. on-edge work and bit trapping). Additionally, there are instances where the setups for a "one-off" simply don't justify the complication or could be more easily done on another tool. In general, the photos and drawings are scanty and confusing.

The router today, with all its accessories, tool bits, jigs and fixtures, really makes woodworking a simple machine process. This book imposes a lot of handwork on the reader—exactly what the router is supposed to eliminate. Almost all of the routing is done with the Elu plunge router, although there is one example using an old fixed-base Stanley. The router table is designed to be used with a Black and Decker Workmate. The fixturing, materials and hardware for the table are, in my opinion, underdimensioned and underrated.

There are many interesting projects in this book and some good reading on the history of the pieces, selection of materials and woodworking in general. But the reader will learn little about the use, jiggging, fixturing, selection or safe handling of routers.

—Pat Warner

Wood Repair, Finishing, Refinishing by Allan E. Fitchett. *Albert Constantine & Son Inc., 2050 Eastchester Road, Bronx, N.Y. 10461; 1989. \$9.95, paperback; 130 pp.*

Allan Fitchett is a fixture at Constantine's. An amateur woodworker, he began hanging around there at some point in the past, asking questions, helping out. He became a source of advice for customers, and he currently directs Constantine's education programs.

This book is too short to encompass everything in depth, but it's an excellent overview of techniques and materials, both old and new. Although some of Constantine's own products appear in these pages, you can get almost any material mentioned at the corner hardware store. Fitchett is full of basic, good advice and pays special attention to safety. He notes, for example, that we cannot trust our own senses to evaluate the toxicity of a chemical—mild-smelling epoxy fumes are very toxic, while sharp-smelling acetone is only mildly toxic. He's a great advocate of reading warning labels, and also points out that listed contents and directions may change as products are improved or modified.

Fitchett has kept in touch with real repair and finishing problems. By breaking down jobs into their separate parts, he makes the work clearly understandable. In fact, there are working "schedules" for a variety of projects. Followed step by step, the schedules will see the novice through almost any job.

The cover may be silly—Fitchett in vivid, spanking-new clothes, aimlessly wire-brushing one part of an old chair while simultaneously inserting three back spindles with his other hand. But you know what you can't tell a book by.

—Jim Cummins

Pat Warner is a designer and furniture maker in Escondido, Cal. Jim Cummins owns a framing shop and lives in Woodstock, N.Y.

•SUMMER WORKSHOPS 1990•
WOODWORKING & FURNITURE DESIGN

- JIM BAREFOOT
Upholstery
- ELLEN DRISCOLL
Wood Sculpture
- ROBERT DEFUCCIO
Chair Design and Development
- MICHAEL EMMONS
Rustic Furniture
- NORA HALL
Classic European Carving • Advanced Carving
- SILAS KOPF
Marquetry, Veneering & Inlay
- PETER KORN & HARV MASTILIR
Basic Woodworking
- JAMES KRENOV
A Personal Approach
- KATHLEEN LOE
Faux and Painted Finishes
- SAM MALOOF
Furniture
- STEVEN PROCTOR
Furniture Making
- GARY ROGOWSKI
Stool Construction

ANDERSON RANCH

A R T S C E N T E R

P.O. Box 5598 • Snowmass Village, CO 81615 • 303/923-3181

Ask for our free catalog.

CERAMICS • PHOTOGRAPHY • PAINTING • CHILDREN'S CLASSES

READER SERVICE NO. 5

Craft Marketing	1	L I S T S
Opportunities	9	
from American	9	
Craft Enterprises	0	

L I S T S

Direct mail is an effective way to market your craft, but only if you mail to the right list. ACE can provide you with up to date lists to reach any segment of the craft market. Our lists are constantly cleaned, purged and updated. They include attendees at the wholesale portions of our craft fairs, shops and galleries listed in AMERICAN CRAFT magazine's GUIDE TO CRAFT GALLERIES AND SHOPS, and subscribers to MATTER, the craft retailing magazine.

- Other ACE craft marketing opportunities include:
 - ACC CRAFT FAIRS. Seven juried shows that are America's
- preeminent craft marketing events.
 - MATTER. The craft retailing magazine - your best advertising vehicle to reach the wholesale craft buyer.

For more information contact:

American Craft Enterprises, INC.
PO Box 10, 256 Main Street, New Paltz, NY 12561
914/255-0039

READER SERVICE NO. 4

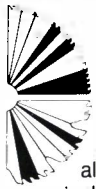

— SINCE 1940 —

KEEN-EDGE

SHARPENING—KEEN-EDGE sharpens, repairs and retips almost all of your sharpenable tools including cutters, saws, drills and router bits.

Ask about our exclusive new process to increase the life of your standard cutters and blades, two to three times.

MANUFACTURING

Our plant is equipped to manufacture special sizes or unusual types of cutters. KEEN-EDGE manufactures carbide tipped cutters and saw blades for special cutting projects.

**Send or Drop Off Sharpening to:
395 EDGEWOOD AVENUE, S.E.
ATLANTA, GEORGIA 30312
(404) 523-5006**

**Also Drop Off and Pick Up at:
3695 LONGVIEW DRIVE
CHAMBLEE, GEORGIA 30341
(404) 455-4356**

**KEEN-EDGE
is limited only
by your imagination.**

Fine Wood Working® SUBSCRIBER LIST SERVICE

We occasionally make our subscriber list available to companies whose products we think may be of interest to you. If you prefer not to receive this mail, just fill out the form below and return it to our subscriber service department (see address below). We'll take care of the rest.

Send this form to:
Subscriber Service Dept.
The Taunton Press
63 South Main Street,
Box 355
Newtown, Connecticut 06470

Please do not share my name and address with other companies.

Name _____
Address _____
City _____ State _____ Zip _____



Hob-Knobing...

...with the best furniture hardware there is. The kind demanding craftsmen have been ordering from us for years. Be it knobs or pulls, rely on our new 70-page catalog to help you with the toughest project. To get your copy of this valuable reference, use circle #401 and send \$4.00 to:

PAXTON HARDWARE LTD.

7818 Bradshaw Road, Dept. FW19, Upper Falls, MD 21156
Quick Shipment Free Mini-Catalog

READER SERVICE NO. 82

ASHMAN TECHNICAL LTD.

Machinery • Tools • Shop Equipment
351 Nash Rd., N., Hamilton, Ont., Can. L8H 7P4
(416) 560-2400

CALL COLLECT

GENERAL

- 10" Table Saw 350-1, 3HP \$1300.
- with Biesemeyer \$1420.
- with EXCALIBUR \$1500.
- 160-2 VS Lathe, 3/4 HP \$1120.
- 260-1 VS Lathe, 1 HP \$2050.
- 1180-1 6" Jointer \$ 495.
- 480 8" Jointer, 1 1/2 HP \$1495.
- 490-1 15" Bandsaw, 3/4 HP \$ 899.

READER SERVICE NO. 94

DE·STA·CO TOGGLE CLAMPS



NOTHING CLAMPS LIKE THE ORIGINAL.



DE=STA=CO

A DOVER RESOURCES COMPANY

P.O. Box 2800, Dept. FW, Troy, MI 48007
(313) 589-2008

READER SERVICE NO. 19

Photos this page: Steven Keull



Rude Osolnik's trademark candlesticks in macassar ebony, which range in height from 14¼ in. to 6¼ in., shown above, evolved from an early 1950 design and in 1955 received the Award of Good Design from the Furniture Association of America. Although Osolnik first started turning laminated Baltic birch plywood in the mid-1960s, the 7-in.-high by 7½-in.-dia. bowl, shown below, was turned in 1988. A pioneer in turning natural-edge bowls, the 75-year-old Osolnik demonstrates that he has not lost any of his finesse at the lathe in the 5¾-in.-high by 6½-in.-dia. cork oak bowl turned in 1987, shown at left.

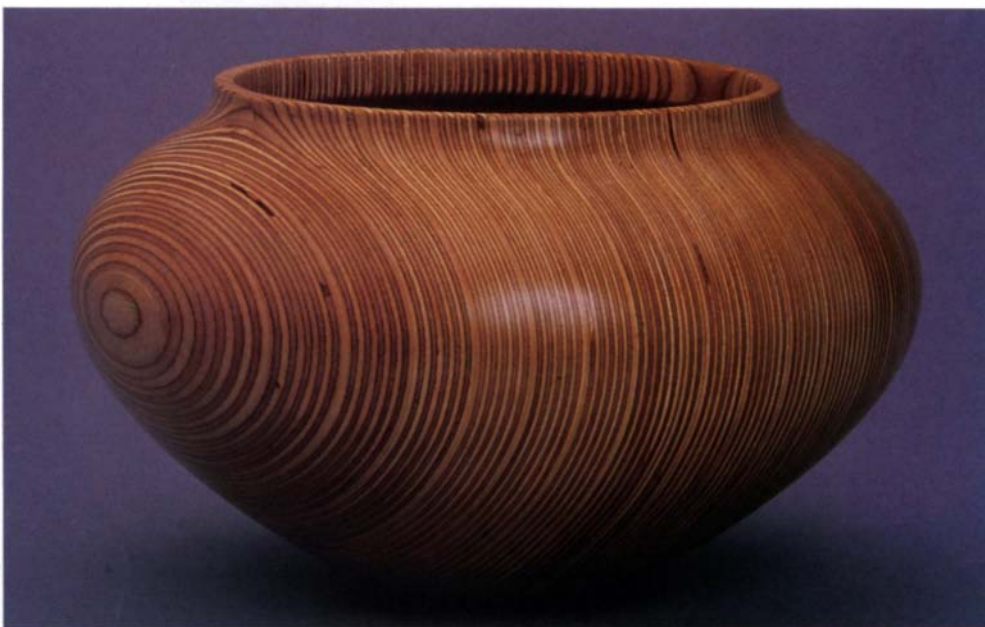

Osolnik retrospective—50 years of turnings

In 1937, Rude Osolnik took a job teaching industrial arts at Berea College, in Berea, Ky. He was to become an important figure in the transition of American crafts, from work based on traditional folk skills and forms to contemporary production, which welcomes experimentation in design and technique. Last October, the Southern Highland Handicraft Guild (SHHG) recognized his achievement with a 50-year retrospective exhibit at the Folk Life Center in Asheville, N.C.

Although Osolnik is a versatile woodworker, his greatest impact has been in the field of turning. Composing freely on the lathe, he has wedded a classical sense of form and proportion to the modern aesthetics of straightforward simplicity, thereby invigorating and updating a long-practiced craft.

Several of his designs have entered the craft culture as woodturners' standards. His dried-flower vases served as prototypes for self-taught turners trying to support themselves at craft fairs in the '70s. He was one of the first turners to loosen up form and use natural edges. And his use of birch plywood and inlaid veneer accents have been an inspiration for the dazzling array of techniques and materials showing up in contemporary work.

The oldest piece in the SHHG exhibit is an onion-shape alabaster vase made in 1939. A 1985 vase in salt cedar echoes that form. Pieces representing every phase of Osolnik's career are in the exhibit, including an oval tray from 1975, when he and a friend had a machine shop fabricate an oval-turning lathe they had invented. Another characteristic form, the tulip-shape bowl, looks elegant in all sizes and species, and free-form bowls from the '50s and '60s appear next to more recent natural-edge vessels, as shown in the middle and bottom photos at left. The exquisite hour-glass shape candlesticks, shown in the top photo at left, something of a signature piece for Osolnik, are represented here in macassar ebony.

Far from relaxing in recent years, the 75-year-old Osolnik has continued in new directions. A 2-ft. by 1-ft. salad bowl in mahogany is almost too big to be functional. And now that the market for natural-edge bowls is here, he's contributing his vocabulary of forms and techniques. A footed sphere in cork oak still has the bark on it. In another piece, two little pink ivory wood bowls from 1987 rise like soda glasses from small button feet.

The Osolnik retrospective shared gallery space with a touring selection from the International Turned Objects Show (ITOS), the current survey of the field put together by Albert LeCoff and the The Wood Turning Center in Philadelphia, Pa.

"Rude's the epitome of the all-around turner," LeCoff said at the opening. "One-of-a-kind, production, they're all great; he gives the same attention to all. He's a master of



Dust Boy, Inc.®

1-2 hp Dust Collectors. Portable – Stationary

Totally Enclosed Fan Cooled

- Cast Aluminum Blowers
- High Efficiency
- Extremely Quiet
- American Made
- 5 Year Warranty

"We Stand Behind OUR Product With Pride"

DUST BOY, INC.

RR 2, Box 269C
Milan, IN 47031

(812) 654-2918
1-800-232-3878



WE WILL NOT BE UNDERSOLD

READER SERVICE NO. 25

SIMPLY — BETTER. VEGA STOCK FEEDER SYSTEM.

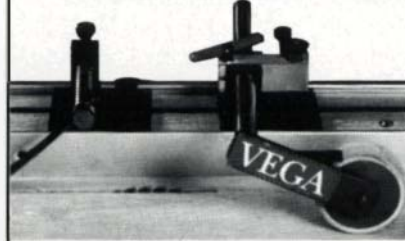

1. Quickly retracts to be out of the way for other operations. No remounting or reattaching.
2. No mounting block on left side of Fence. Rip width measurement unchanged.
3. Fast adjustability to 2 1/2" thickness. Roller extends to 10" from fence.
4. Fits most fences and guides the stock with precision.



VEGA

Route 3, Box 193
Decatur, Illinois 62526
217/963-2232

Thoughtfully designed machines made in the USA.

READER SERVICE NO. 66

NEW Blast Gates

Your Best Price Source

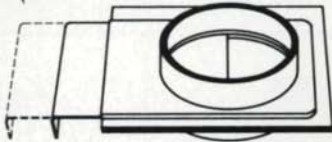

FOR YOUR FREE CATALOG OF OUR COMPLETE
DUST COLLECTION ACCESSORIES, PLEASE PHONE.

3 inch - \$7.95	5 inch - \$11.95
4 inch - \$9.95	6 inch - \$14.95

PolyVent Company 1-800-366-4202

1077 (D) Shary Circle
Concord, CA 94518
FAX: 415-676-1707



READER SERVICE NO. 56

* SANDPAPER *

NO GIMMICKS — GREAT PRICES

BELTS: GRITS ASSORTED

SHEETS: (9 x 11) PRICE

UNLESS OTHERWISE SPECIFIED

CABINET PAPER

1 x 30	\$.69 ea	3 x 24	\$.80 ea	50 /pk	100 /pk
1 x 42	.69 ea	3 x 27	.83 ea	40-D	\$16 /pk \$30 /pk
1 x 44	.69 ea	4 x 21 1/4	.91 ea	50-D	15 /pk 27 /pk
2 1/2 x 16	.73 ea	4 x 24	.94 ea	60-D	14 /pk 25 /pk
3 x 18	.74 ea	4 x 36	1.14 ea	80-D	13 /pk 23 /pk
3 x 21	.77 ea	6 x 48	2.98 ea	100 thru 150C	12 /pk 21 /pk
3 x 23 1/4	.80 ea	2 1/4 x 80	2.47 ea		

OTHER SIZES ON REQUEST

FINISHING PAPER

NO LOAD PAPER

	50 /pk	100 /pk
80-A	\$ 9 /pk	\$16 /pk
100 thru 280A	8 /pk	14 /pk
180-A thru 400-A	\$10 /pk	\$18 /pk

WET / DRY PAPER

PRESSURE SENSITIVE

	50 /pk	100 /pk
ADHESIVE DISCS!	220 thru 600A	\$13 /pk \$23 /pk

6"	\$1.06 ea	* OTHER ITEMS *	* JUMBO CLEANING STICK *
8"	1.99 ea	* WIDE BELTS	\$8.80
9"	2.46 ea	* ROLLS	
10"	3.05 ea	* FLAP WHEELS	
12"	4.45 ea	* PUMP SLEEVES	
15"	6.95 ea		

SEND MAIL ORDERS TO:
ECON-ABRASIVES
P. O. BOX B865021
PLANO, TX 75086

NATIONAL 1-800-367-4101
IN TEXAS (214) 377-9779

* MINIMUM ORDER \$25.00

* MASTERCARD, VISA OR CHECK

* SATISFACTION GUARANTEED!!

* TEXAS RES. ADD 7% SALES TAX

* SHIPPING CHARGES ADD \$4.25

WE'LL PAY YOU A HUNDRED BUCKS TO JOIN UP WITH US.

Put the new Delta Plate Joiner in your shop and Delta will put a check for \$100 in the mail to you.

This stationary Plate Joiner goes way beyond a portable joiner. A foot pedal controls blade movement so both hands are free to control your work and speed up the operation.

It handles edge, face, bevel edge, bevel end, miter joining and Tee-molding. And uses all three biscuit sizes.

An adjustable table handles large workpieces and accommodates an adjustable stock stop.

If you're ready to join up with the best, call toll free for the name of your participating Delta Distributor.

Delta International
Machinery Corp.,
800/438-2486.

* Offer good only on purchases from participating distributors in the continental U.S., Alaska and Hawaii, from January 1 thru June 30, 1990.

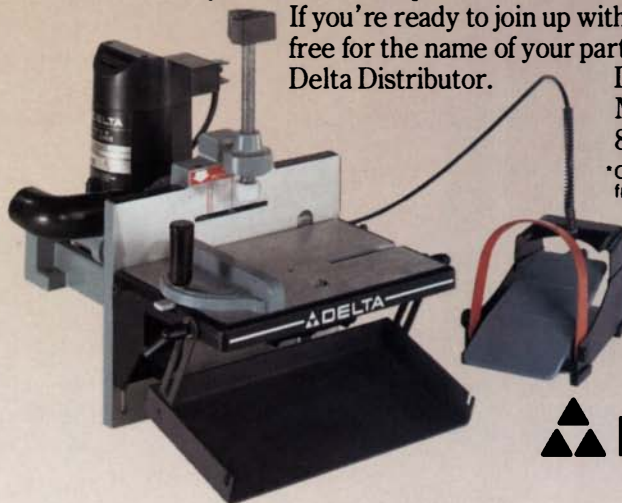

Building
On Tradition
DELTA
A Pentair Company

READER SERVICE NO. 24

form—no one can control form better. He pioneered woodturning in the South. And it was all done by legwork—demonstrating and word of mouth. He's never gotten media attention or sought it. He wasn't trying to make a name for himself. He really *loves wood*."

It is appropriate that the SHHG is sponsoring the exhibit, since Osolnik has been a strong force in the Guild for many years. "He was a mainstay for the Guild Fair all during the '60s and '70s," says Guild Director Jim Gentry. "During his tenure as treasurer, we developed our financial system. He was president of the board when they hired Bob Gray, previously the director of The Worcester Center for Crafts, Worcester, Mass., who served as director from 1961 to 1981 and brought in the current standard of professionalism."

Another admirer of Osolnik's is turner Stoney Lamar of Saluda, N.C. "The retrospec-

tive demonstrates Rude's idea of tradition as change, which is what the SHHG has done," he says. "Especially in the South, a lot of people think tradition is tradition, but for 60 years now, Rude's been showing that a vital tradition moves forward. He's made us possible."

Osolnik's capacity for hard work is legendary. "I used to teach from 7 a.m. to 5 p.m.," he says. "Then I'd get up at 2 a.m. and work on the lathe until 6 a.m. Even now I don't need more than four-hours sleep a night." This energy has led to long production runs of some items; he estimates that he's made more than 100,000 candlesticks. Yet careful attention is given to each one so that the gracefulness of the curve is maintained.

Unifying production work-rates with one-off care and design is a principle with Osolnik; he believes that everyday items should be well designed and beautiful and that such pieces

will enhance the user's life. "I started turning in 1927," Osolnik says, "and I get just as much fun out of it now as I did when I started." In *Lathe-Turned Objects*, the ITOS catalog (available from The Wood Turning Center, Box 25706, Philadelphia, Pa. 19144), he writes: "My woodworking is a labor of love. It gives me a feeling of being in church, or in God's presence, when taking a piece of wood and making something out of it... I am at peace with the world when working with wood."

—Fletcher and Carol Cox, *Tougaloo, Miss.*

EDITORS NOTE: "Rude Osolnik: A Retrospective" is touring for two years and some dates are still open. A catalog of the retrospective featuring full-color photos of 50 objects, with essays by world-renowned woodturner Dale Nish and Donald C. Peirce, curator of decorative arts at the High Museum of Art in Atlanta, Ga., is available for \$11 from the Southern Highland Handicraft Guild, Box 9545, Asheville, N.C. 23305.

Photo: Rickey Yanaura



Above: Craig Nutt's 24Hx28Wx18D table, with a padauk top and a base finished with oil paints, heralds the dawning of the age of asparagus. Below: Chad Voorhees constructed this silver chest, 36½Hx25Wx20D, from quilted maple and macassar ebony.



Photo: Clay Algeo

Woodworking grants

Two of the 10 artists selected to receive Southern Arts Federation/National Endowment for the Arts Grants in 1989 are furnituremakers. Craig Nutt and Chad Voorhees were each awarded \$5,000 in recognition of their woodworking talents. Both Nutt and Voorhees were featured in one-man shows by the Great American Gallery in Atlanta, Ga.

Craig Nutt is an Alabama woodworker who has had a longtime fascination with vegetables, both as a consumer and grower and as a member of the now-defunct Raude lunas Marching Vegetable Band.

The "Vege Table," shown in the top photo at left, is a natural evolution of Nutt's vegetable fantasy to furnituremaking, which has been the major focus of his work since graduating from the University of Alabama in 1972. Cayenne peppers, asparagus and carrots make remarkable table legs. Historical references can also be found in Nutt's tables. A stalk of asparagus bent just right bears an uncanny resemblance to a Queen Anne cabriole leg. Trained in traditional cabinetmaking techniques, Nutt combines craftsmanship with the off-beat and the absurd to create pieces of furniture that are functional, sculptural and enjoyable.

Voorhees draws his inspiration from time he spent at the Shakers' settlement in Mt. Lebanon, N.Y. The utilitarianism of Voorhees' Shaker designs emphasizes the beauty of wood with high-quality craftsmanship, as shown in the bottom photo at left. Traditional joinery worked into pleasing forms that are sparingly decorated create an overall sense of refinement. Departing somewhat from the Shaker tradition, the fanciful legs and exotic wood inlays of the North Carolina woodworker's more recent works reflect the training he received at Virginia Commonwealth University, where he received a bachelor of fine arts while studying sculpture and furniture design.

—Pamela Leonard, *Atlanta, Ga.*

Photo: Kathryn Fox



This collection of braces was just one of many such exhibits seen by the 200 members attending last year's annual meeting of the EAIA in Dearborn, Mich.

Tool collectors congregate

Tool collectors from all over the country congregated at the Henry Ford Museum in Dearborn, Mich., last year to show off, talk about, use, buy and sell old tools. The annual meeting of the Early American Industries Association (EAIA) attracted nearly 200 members with varying interests in antique tools, from private collectors to managers of museum collections and antique dealers. Many of the members are also actively engaged in the crafts, either making reproductions of traditional tools or actually putting them to use.

Malcolm MacGregor, a professional woodworker in Durham, N.H., who specializes in reproducing 17th- and 18th-century furniture, falls into this latter category. MacGregor's demonstration of making complex molding patterns with hand molding planes was one of the highlights of the May meeting. MacGregor explained that even in the old days most woodworkers didn't have a plane for every molding pattern, so he showed how simple molding planes could be used to reproduce complex patterns. After sketching the pattern on the end of the board, he planed

**NORTHSTATE
15" PLANERS**



- Model 310: \$779
- Powerful 3 hp motor
- Cast iron construction
- Magnetic switch
- 1 year warranty
- Dust hood
- Anti-kickback
- Stand included



- Model 315: \$849
- Same features as the Model 310 plus:
- Table extension
- 2 speeds

NORTHSTATE CABINET SHOP SHAPER



- 3 hp/1 ph, 5 hp/3 ph
- 2 speed-reversible
- 2 spindles: 3/4", 1-1/4"
- 1/2", 1" available
- Router collets avail.
- Cast iron table
- Spring hold down & miter gauge
- Extra heavy duty
- 1 year warranty
- \$1,095
- FREE FREIGHT
- Tiltspindle model avail.

**NORTHSTATE
10", 12", 14" CABINET SHOP SAWS**



- 3, 5, 7-1/2 hp motors
- Magnetic controls
- Cast iron top
- Uni-lock fence
- VERY HIGH QUALITY
- \$1,125 w/std fence
- \$1,225 with 50" rip fence
- Free freight on portable tools
- HTC BASES AVAIL

LENEAVE QUALITY—SINCE 1957

NORTHSTATE PLANERS



- 20", 5 hp: \$1,350
- 24", \$2,595
- 5 hp & 7-1/2 hp

NORTHSTATE BANDSAWS

- 14", 1 hp: \$295
- 18", 2 hp: \$795
- 20": \$1,495
- 24": \$2,465

PORTER CABLE

- 555: Plate Jointer: \$158
- 330: Sander: \$54
- 360: Sander: \$174
- 505: Sander: \$108
- 351: Sander: \$124
- 352: Sander: \$127
- 363: Sander: \$179
- 362: Sander: \$184
- 361: Sander: \$168
- 7548: VS jigsaw: \$124
- 9627: Rec. Saw: \$125
- 518: Router: \$335
- 520: Router: \$315
- 690: Router: \$121
- 630: Router: \$110
- 314: Saw: \$119
- 315: Saw: \$110
- 9118: Plane Kit \$185

NORTHSTATE 8" CABINET SHOP JOINTER



- Heavy cast iron const.
- 2 hp, single phase
- 9" x 67" bed
- 3 knife cutter head
- Dual tilt fence
- Magnetic controls
- SALE: \$795
- 6" jointer: \$350
- 12" jointer: \$1,895
- Delta 8" jointer: \$1,295

RAISED PANEL DOOR MACHINE



- Requires 6 sq ft space
- Set-up time reduced by 80%
- Easy top side adjustments
- All cutters fully guarded
- Cutters included
- Safe, easy operation
- Freeborn & Freud Shaper Cutters avail.

NORTHSTATE WIDE BELT SANDER



- Best buy in the industry!
- Variable speed
- Platen head
- Dual motors
- Heavy cast iron & steel
- Plate construction
- 10, 15, & 20 hp
- 25" List: \$8,650
- SALE: \$5,895, 15 hp
- 37" List: \$12,900
- SALE: \$8,888, 20 hp
- Phase converter avail.

NORTHSTATE DUST COLLECTORS

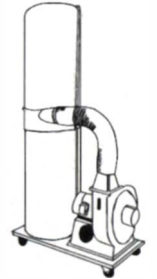

- 2 hp, 2 bag: \$325
- 3 hp, 4 bag: \$489

SENCO

- SN-4 \$474
- SN-2 \$420
- SFN-2 \$380
- SFN-1 \$265
- SKS \$243
- LS2 \$238
- LS5 \$257
- PW \$246

HITACHI

- C15FB: Mitre Saw: \$369
- C8FB: Comp. Mitre: \$465
- TR-12: Pl. Router: \$167
- F20A: Plane: \$95
- CC14: Cut-off saw: \$196
- D10D: Cordless Drill: \$109
- CB75F: Re/and-saw: \$1,589

DEWALT

- 7749: Radial Arm Saw: \$572
 - 7770-10: Radial Arm Saw: \$779
 - 7790: Radial Arm Saw: \$979
 - 1765: Belt/Disc Sander: \$389
- All Dewalt Ind. radial arm saws available
- Freeborn Shaper Cutters
 - Mini-Max Machinery
 - Adjustable Clamps

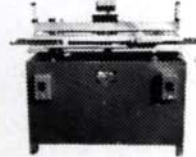

UNIQUE Raised Panel Door Machine

- A Raised Panel Door Machine that machines all five components with only one operator!
- Eliminates Pre-Bandsawing of arches
- Produce a complete door in less than 2 minutes

DELTA SPECIALS

- 46-541: Lathe: Call for Promo Price
- * 43-375: Shaper: \$1,495
- * Unisaws - Prices start at \$1,225
- 40-601: Scroll Saw: \$575 after rebate
- 31-730: Belt/Disc Sander: \$995
- 37-350: 8" Jointer w/stand: \$1,295
- 34-444: 10" Contr. Saw: \$595
- 34-445: 10" w/Unifence: \$685 after rebate
- 28-283S: 14" Bandsaw: \$588 after rebate
- 28-245: 14" Bandsaw \$489
- 17-900: 16-1/2" Drill Press: \$375
- 43-122: Shaper: \$579
- 33-990: 10" Radial Arm Saw: \$535
- 34-985: Stock feeder: \$535 after rebate
- 34-994: Stock feeder: \$839 after rebate
- 34-995: Stock feeder: \$745 after rebate
- * access. specials on shapers and Unisaws
- Complete Delta line available.

We try not to be undersold, tell us our competitors' prices. "Prices Subject to Change"

LENEAVE MACHINERY & SUPPLY COMPANY

305 West Morehead St., Charlotte, NC 28202 Outside NC 800-326-3431; (704) 376-7421

INDEX TO ADVERTISERS

Accuset Tool	27	Dollar Trading Co.	8	Kuster Mfg.	96	Shaker Workshops	93
Acme Electric	17	Dust Boy	111	L. I. Laminates	26	Singley Specialty	37
Adams Wood	32	Eagle America	29	Laguna Tools	30	Sisco Supply	33
Advanced Machinery Imports	20	Early Music Shop	5	Leigh Industries	13, 15	Skycroft Tools	32
Amazon	23	Ebac	16	LeNeave Supply	113	Smith & Co.	29
American Craft Ent.	108	Econ-Abrasives	111	Lie-Nielsen Toolworks	9	Snell Lumber	23
American Tool	9	Everlast Saw	16	Lignomat USA	10	Sun Designs	5
Anderson Ranch	108	Fisher Hill Products	107	Lobo Power Tools	29	Sunhill Enterprises	103
Arrowmont School	37	Floral Glass & Mirror	18	Manny's Woodworker's Place	20	Tarheel Filing Co.	98
Ashman Technical	109	Forrest Manufacturing	15	Manufacturers Service	10	The Taunton Press	34, 35, 99
Auton Co.	103	Freud	21	Marling Lumber	95	Tech Paper Corp.	18
Aviation Supply	96	Furniture Designs	29	Martin Guitar	100	Tool Crib of the North	17
Axminster Power Tool	31	Garrett Wade	39	Mason & Sullivan	29	Tooland Corp.	38
Ball & Ball	36	Gil-Lift	23	McFeely Hardwoods	19	Tools on Sale	25
Bartley Collection	94	Glass & Mirror Craft	94	Michael Farr	13	Total Shop	93
Berea Hardwoods	27	Global Re-Leaf	107	Midwest Dowel Works	36	Transpower	100
Better Built	5	Grizzly Imports	2, 28, 95	Mini Max	37	TrusLock	5
Biesemeyer	19	HTC Products	15	MLCS	13, 92	Vega	111
Blume Supply	10	Harper Hardware	33	Neuway Air Systems	5	Veritas	33
Bosch Power Tools	115	Hartwood Ltd.	95	Northland Woodworking	33	Steve Wall Lumber	94
Boulter Plywood	18	Haystack Mtn. School	27	Nyle Corp.	19	Walter A. Wood Supply	7
BrandMark	33	Hida Japanese Tool	93	Paramount Saw	7	Wedge Innovations	11
Calculated Industries	31	Highland Hardware	95	Paxton Hardware	109	Whitechapel Brasses	9
Capital Tools	5	Home Lumber	18	Penn State Industries	27	Whole Earth Access	105
Cascade Tool	31, 36	Horton Brasses	5	Performax Products	38	Wilke Machinery	14
Classified	101-103	Hydrocote	23	Philipps Brothers	98	Williams & Hussey	26
Clayton Enterprises	29	Imported European Hardware	33	PolyVent	111	Williams Tool	9
Maurice L. Condon	16	Inera Jig	24	Pootatuck	19	Wood-Mizer	95
Constantine	13	Industrial Abrasives	98	Porta-Nails	96	Woodpeckers	5
Corob Corp.	7	International Tool Corp.	106	Powermatic	97	Woodcraft Supply	107
Counselor Profiles	100	Japan Woodworkers	37	Rio Grande Univ.	13	Woodmaster	9
Craft Supplies USA	28	Jesse Jones Industries	100	Ross Industries	38	The Woodworking Shows	31
De-Sta-Co	109	K & S Specialty	37	Santa Rosa Tool	94	Woodworking World Shows	106
Delmhorst	13	Keen Edge	109	Schuler Toolworks	100	Worcester Center for Crafts	95
Delta	32, 93, 111	Keller Dovetail	37	Seven Corners Ace Hardware	25	Workbench Tool	13

small V-grooves and then proceeded to connect the grooves with various curves and molding profiles. In a matter of minutes, he had planed a 2-ft. length of a complex molding. When called upon to produce more than one length of molding, he makes each cut on every board before going on to the next cut, to ensure that the profiles will all match.

Between demonstrations, members were treated to tours of some of the historic buildings that make up the Henry Ford Museum, such as the conservation department, where a Concord coach was in the process of being carefully restored, and Noah Webster's house that was moved to Dearborn from New Haven, Conn., in 1937, but was only recently restored.

The EAIA publishes *The Chronicle*, a quarterly journal that contains articles about all sorts of early technology. Members also receive a bimonthly newsletter and have access to the organization's library of books and films. Recently the EAIA began offering tours to Europe that take members and their guests to places that display traditional crafts and antique tools.

This year's annual EAIA meeting will be held from May 17 through 19 in Mystic, Conn. For more information, write EAIA, c/o John Watson, Box 2128, Empire State Plaza, Albany, N.Y. 12220.—*Kathy Fox, Summit, N.J.*

E. Carlyle Lynch Jr. 1909-1989

E. Carlyle Lynch, whose splendid drawings and instructional articles have been part of *Fine Woodworking* magazine for more than 10 years, died Dec. 12 at age 80.

Lynch's articles always had a loyal following among our readers, because he was not only a master draftsman who devoted much of his life to measuring classic antiques at places like Old Sturbridge Village in Massachusetts or the Museum of Early Southern Decorative Arts in Winston-Salem, N.C., but he was also a highly skilled builder who reproduced many of the pieces himself. And when he measured a piece, it was with the craftsman's eye, searching for those little details that would help him explain how the original maker had done his work.

I first met Carlyle shortly after I started working at the magazine six years ago. I had long admired his work, but didn't know enough about period furniture to fully understand how good it was. Carlyle must have sensed what a novice I was, but instead of criticizing or complaining, he just started teaching me. The teacher role was familiar to him, since he had founded the industrial arts program at Lexington, Va., High School and later taught at the high school in Broadway, Va., where he lived. Along the way, he was a furniture designer for the highly regarded Craft House in Harrisonburg, Va.

He continued to teach me a lot over the

years, but the teacher soon became more of a friend as he shared his great love for the South, especially Virginia's Shenandoah Valley, and its craftsmen and antiques. And there was something else—perhaps his humor and wit or his concern for others or his elegant Southern manners—that made you sense he had mastered the craft of living well as thoroughly as he mastered the craft of working with wood.

He is survived by his wife, Jane McDowell Lynch; two sons Ernest C. Lynch III of Charlotte, N.C., and E. Houston Lynch of Harrisonburg, Va.; a daughter, Linda Lynch Cechura of Moedling, Austria; a step-daughter, Carolyn Craig Williams of Charlottesville, Va.; a sister, Elizabeth Lynch McShane of Rocky Mount, N.C.; and four grandchildren.

* * *

Lynch left a legacy of more than 100 measured drawings, many of which are available from Garrett Wade or Woodcraft Supply and in Canada from Lee Valley Tools.

Shortly before his death, he completed work on his last article, this one describing how to build a chest-on-chest (see p. 76 of this issue) based on designs by the prominent 18th-century Charleston, S.C., cabinet-maker Thomas Elfe. Lynch's previous *FWW* articles include building a post-office desk (*FWW* #73, p. 72), making a wooden lathe (*FWW* #57, p. 44), building a southern hunt-board (*FWW* #39, p. 74) and making a Hepplewhite bureau (*FWW* #48, p. 42).

—*Dick Burrows*

Photo: Courtesy of National Museum of American Art/Gene Young

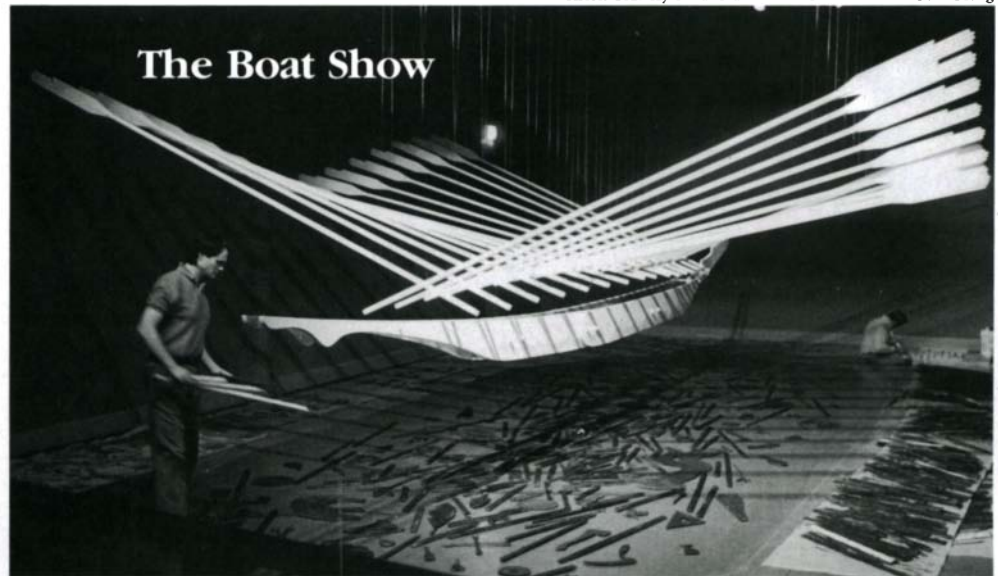

The boat has played a prominent role in mythology, religion, literature and art. From Egyptian burial barges to today's science-fiction spaceships, the image of the boat has been used as a poetic device to transport mankind imaginatively to distant realms. Artists' interpretations of ships and voyages were shown at "The Boat Show: Fantastic Vessels, Fictional Voyages," which concluded last winter at the Renwick Gallery, National Museum of American Art, Smithsonian Institution in Washington, D.C. Larry Kirkland's "Soulboat," shown above, is based on his experiences in the Far East. The hanging sculpture was inspired by Southeast Asian fishing vessels and canoes that incorporate human forms as well as Oriental ideas of the soul's journey to the afterlife as a voyage by boat. Kirkland says, "My man/person/boat is the recently departed spirit. To me, the moment the body dies and the new journey begins must be like the second a bird takes flight...a great upward rush of wing."



The late Carlyle Lynch shown measuring a drawer on a tool chest made by Duncan Phyfe in New York City.

Notes and Comment

Got an idea you'd like to get off your chest? Know about any woodworking shows, events or craftsmen of note? Just finished a great project? If so, we'd like to hear about them. How about writing to us? And, if possible, send photos (preferably with negatives) to Notes and Comment, Fine Woodworking, Box 5506, Newtown, Conn. 06470-5506.

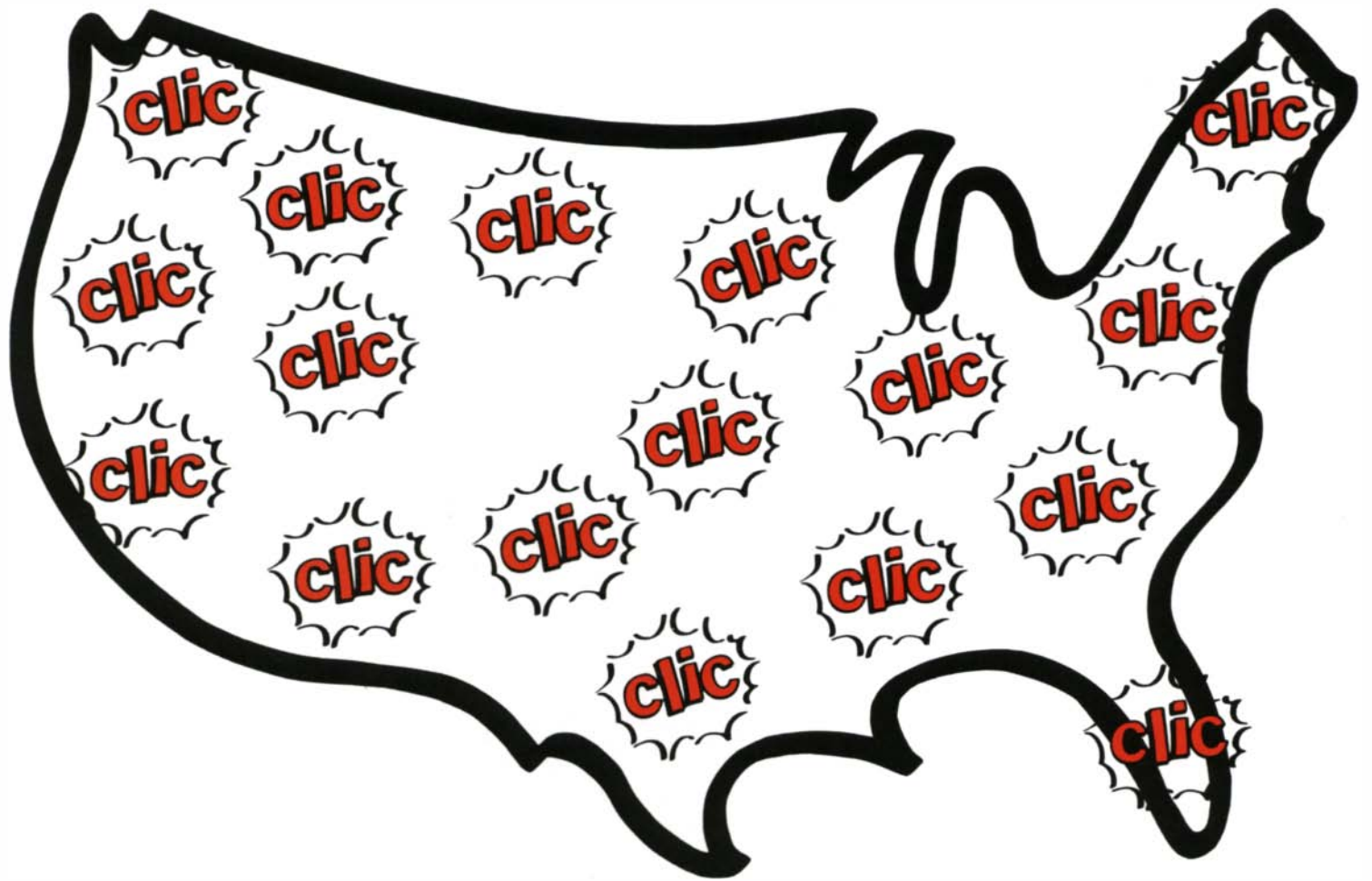

New Bosch Jig Saws Are Clicking With Woodworkers All Over The Country.

**The First Jig Saws That Need
No Tools To Change Blades — Introducing
The CLIC™ Quick Change System.**

The next time you're hunting for a screwdriver to change a jig saw blade, something in your head should go "click." That's the sound of the new Bosch Clic jig saws when you change blades.



As Simple As... Pushing in the orange button inside the top handle. Turning the handle three times and taking the old blade out. Putting in the new blade, turning the knob back until it clicks. Raising the orange button and locking the Bosch bayonet blade in tight.

No set screw to lose. No screwdriver or allen wrench to search for. Fast. Easy. Convenient.

The Clic quick change system is available on 3 new Bosch jig saws: single speed Model 1582, variable

speed 1582VS and dustless variable speed 1582DVS.

All 3 deliver smooth, counter-balanced power with a choice of 3 orbital actions, plus straight reciprocating. There's even an optional guide rail system to help make straight cuts of any length in thinner materials.

So start clicking with the world's first jig saws that don't need a tool to change blades. To find them, just look in the Yellow Pages under "Tools — Electric" for your nearest Bosch Power Tool Distributor.



BOSCH

"Quality You Can Hold On To."™

Copyright 1990 © Robert Bosch Power Tool Corporation.



Photos: Michael Tropea

HIGH IMPACT, LOW RELIEF

Rick Harney's free-standing bas-relief carvings delight and trick the eye. His portraits appear three-dimensional and lifelike, but they are actually carved into boards that are $\frac{3}{4}$ in. to $1\frac{3}{4}$ in. thick. His works are based primarily on photos found in old family scrapbooks and include "Louie," above right, which is 24Hx14Wx1 $\frac{3}{4}$ D bass-wood; "Sunning," top left, which is 29Hx25Wx1 $\frac{3}{4}$ D jelutong; and "Einstein," bottom left, which is 36Hx14Wx $\frac{3}{4}$ D pine. Finished pieces are oiled, varnished and colored with layered washes of artists' oil paints. Harney, who lives and works in Normal, Ill., began sculpting fiberglass in 1975, but in 1985 health problems forced him to give up polyester materials and he began carving his portraits in wood.