

May/June 1986, No. 58, \$3.75

# Fine Woody Working

Shaker Sewing Desk

French Polishing

All About Walnut

The Scraper

Thickness Sander Plans

Hanging Cabinet Doors

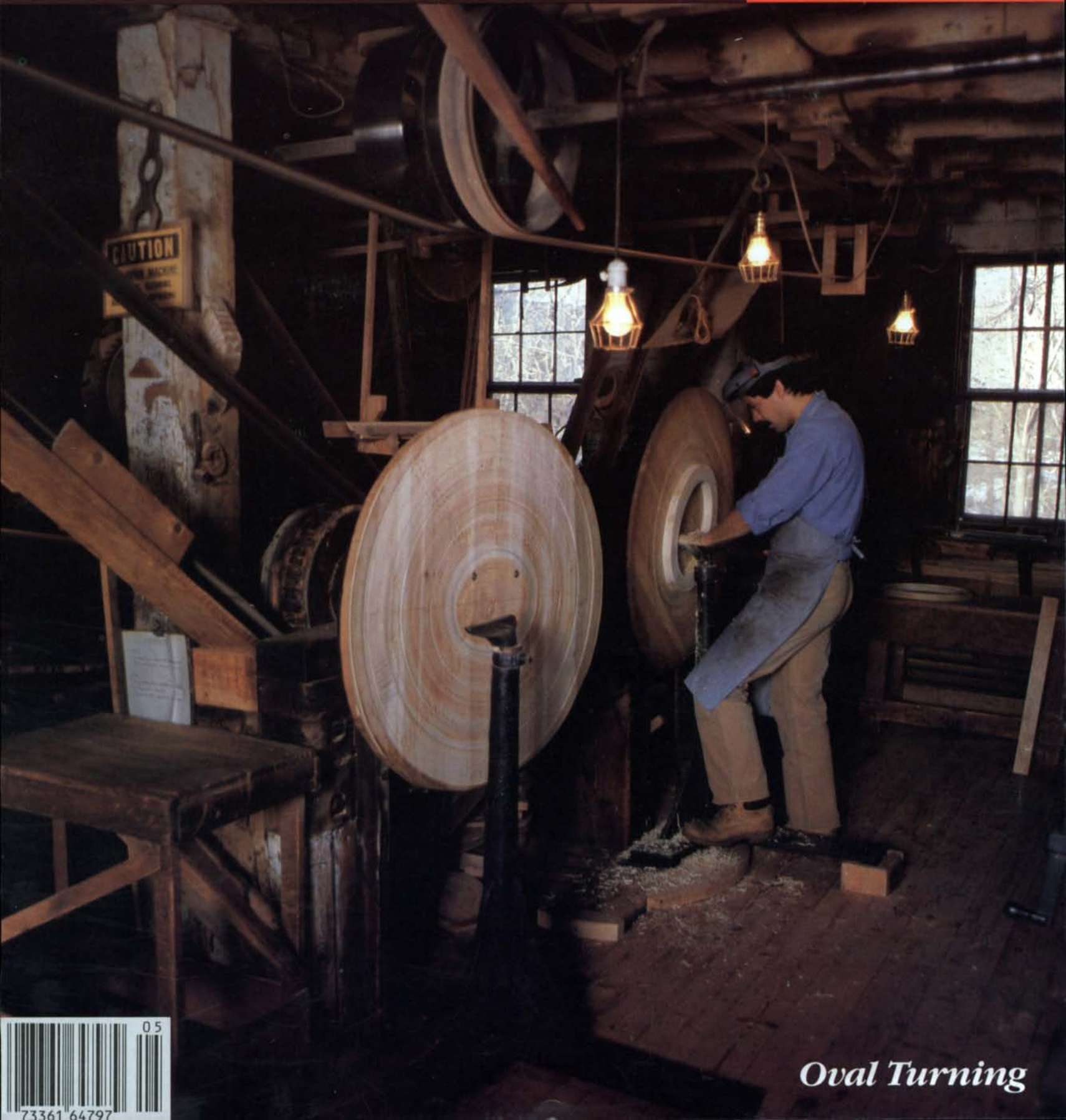

*Oval Turning*



# Every Woodworking Project Starts With A Saw

**SPECIAL FEATURES ON ALL FREUD SAWS:**  
**BODY PLATE:** 42 to 44 Rockwell "C" scale. Heat treated.  
**EXPANSION SLOTS:** Allows blade to expand without distorting.  
**ARBOR HOLES:** Machined and ground to perfect tolerances.  
**MAX RUN OUT TOLERANCES:** ±.003.  
**MAX RPM'S:** On a 10" diameter is 7000.



**Save On The World's Best Carbide Tipped Sawblades Extended Through June 30, 1986.**

Premium Quality

Premium Quality



**LU84M**  
 Hook angle 7°  
 Carbide Used: C4

While this type of blade is a compromise of the following blades, it will give you the results you expect in your shop. No one blade will do it all, however this is the one that comes closest. Most woodworkers we know have one of them. They are practical and inexpensive.



**LU85M**  
 Hook angle 7°  
 Carbide Used: C4

This is the world's best production made carbide sawblade. You can be sure of one thing that we are out to prove: You can spend as much as twice the price of our LU85M blade, but you will not find a better one!! We guarantee it! The use of this blade should be limited to super fine finish work only. The primary and secondary bevels and the teflon coating make this unique sawblade so very precise that the cut seems effortless in all kinds of materials.



**LM72M**  
 Hook angle 20°  
 Carbide Used: C2

This blade is designed for fast ripping along the grain of the wood. Excellent finish is obtained when ripping. The advantage of using a C2 grade carbide is to allow us to use an aggressive 20° hook for fast ripping and yet go through occasional knots without fracturing the tips.

STOCK #	DESCRIPTION	LIST	SALE
LM72M008	8 x 24 x 5/8 Flat Top	\$ 56.98	\$39.99
LM72M010	10 x 24 x 5/8 Flat Top	64.85	43.99
LM72M012	12 x 30 x 1 Flat Top	86.57	49.99
LU84M008	8 x 40 x 5/8 Comb.	71.53	43.99
LU84M009	9 x 40 x 5/8 Comb.	70.99	43.99
LU84M011	10 x 50 x 5/8 Comb.	74.51	43.99
LU84M012	12 x 60 x 1 Comb.	112.60	63.99
LU85M008	8 x 64 x 5/8 ATB	93.27	59.99
LU85M009	9 x 72 x 5/8 ATB	101.98	63.99
LU85M010	10 x 80 x 5/8 ATB	110.88	72.99
LU85M012	12 x 96 x 1 ATB	134.30	83.99

218 Feld Ave., High Point, NC 27264 • (919) 434-3171  
 1570 Corporate Dr., Suite G, Costa Mesa, CA 92626 • (714) 751-8866  
 In Canada 1(800) 387-7415

- In California  
 Call Toll Free:  
 1-800-824-0141
- If You Live  
 In This Area:  
 Call Toll Free:  
 1-800-824-8045
- If You Live  
 In This Area:  
 Call Toll Free  
 (Outside NC)  
 1-800-334-4107





An overhead belt system and much lubricating oil keeps these 19th-century elliptical lathes turning at the Old Schwamb Mill in Arlington, Mass. For an idea of what such work is like, and an explanation of how an elliptical lathe spins, turn to p. 74.

### The Taunton Press

Paul Roman, publisher; Janice A. Roman, associate publisher; Tom Luxeder, business manager; Carol Marotti, personnel manager; Lois Beck, office-services coordinator; Pauline Fazio, executive secretary; Mary Ann Colbert, secretary; Susan McCann, receptionist. Accounting: Irene Arfaras, manager; Mary Ames, Nanette Heroux, Elaine Yamin. Art: Roger Barnes, design director; Vickie Joy Stansberry, art assistant. Books: Leslie Carola, publisher; Heather Brine Lambert, associate art director; Scott Landis, Christine Timmons, associate editors; Nancy Stabile, copy/production editor; Martha Higham, secretary. Fulfillment: Carole E. Ando, subscription manager; Terry Thomas, assistant manager; Gloria Carson, Dorothy Dreher, Donna Leavitt, Peggy LeBlanc, Denise Pascal, Heather Riccardi, Patricia Rice, Nancy Schoch; Ben Warner, mail-services clerk. Robert Bruschi, distribution supervisor; David Blasko, Mary Ann Castagliola, Linnea Ingram, John Kerstein, Aaron Nathenson, Marchelle Sperling, Nicholas Tamburri. Manufacturing: Kathleen Davis, director; Gary Mancini, manager; Barbara Bahr, David DeFeo, coordinators; Deborah Cooper, Dinah George, Margot Knorr, production assistants; Claudia Blake Applegate, system operator. Marketing: Dale Brown, director; Rosemarie Dowd, trade sales coordinator; Laura Lesando, executive secretary. Promotion: Jon Miller, manager; Molly Turmelle, assistant manager; Anne Feinstein, assistant art director. Video: Rick Mastelli, producer/director; Don Goff, Jr., production assistant.

Advertising and Sales: Richard Mulligan and James P. Chiavelli, national accounts managers; Vivian E. Dorman, associate sales representative; Carole Weckesser, senior sales coordinator; Claudia Inness, circulation assistant. Tel. (203) 426-8171.

### Editor

Paul Bertorelli

### Art Director

Roland Wolf

### Associate Editors

Jim Cummins  
Roger Holmes  
Dick Burrows  
David Sloan

### Copy Editor

Nancy-Lou Knapp

### Assistant Art Director

Kathleen Creston

### Editorial Secretary

Cindy Howard

### Contributing Editors

Tage Frid  
R. Bruce Hoadley  
Michael S. Podmaniczky  
Simon Watts

### Consulting Editors

George Frank  
Otto Heuer  
Richard E. Preiss  
Norman Vandal

### Methods of Work

Jim Richey

*Fine Woodworking* (ISSN 0361-3453) is published bimonthly, January, March, May, July, September and November, by The Taunton Press, Inc., Newtown, CT 06470. Telephone (203) 426-8171. Second-class postage paid at Newtown, CT 06470, and additional mailing offices. Copy-right 1986 by The Taunton Press, Inc. No reproduction without permission of The Taunton Press, Inc. *Fine Woodworking*® is a registered trademark of The Taunton Press, Inc. Subscription rates: United States and possessions, \$18 for one year, \$34 for two years; Canada and other countries, \$21 for one year, \$40 for two years (in U.S. dollars, please). Single copy, \$3.75. Single copies outside U.S. and possessions, \$4.25. Send to Subscription Dept., The Taunton Press, PO Box 355, Newtown, CT 06470. Address all correspondence to the appropriate department (Subscription, Editorial, or Advertising), The Taunton Press, 63 South Main Street, PO Box 355, Newtown, CT 06470. U.S. newsstand distribution by Eastern News Distributors, Inc., 1130 Cleveland Road, Sandusky, OH 44870.

### DEPARTMENTS

#### 4 Letters

#### 10 Methods of Work

More sawhorses; raised panels on the jointer; wood-branding iron

#### 14 Questions & Answers

Upscale photo problem; warped tabletop

#### 100 Events

#### 106 Books

#### 108 Notes and Comment

Tree circus; photo tips; product review

### ARTICLES

#### 30 Shaker Casework by David Lamb

*Simplifying the glories of Sheraton and Chippendale*

#### 37 Hanging a Cabinet Door by Roger Holmes

*Swinging with brass butt hinges*

#### 40 Router mortising Soss hinges by C.B. Oliver

#### 41 Walnut by Jon Arno

*The cabinetwood par-excellence*

#### 44 More on Bandsawn Veneer

by Paul Harrell and Monroe Robinson

*Getting the most out of your precious planks*

#### 46 Malletsmithing by Michael Hanner

*Make your own quality croquet set*

#### 50 Furnituremaking in Italy by Josh Markel

*Competition and cooperation*

#### 54 Shopbuilt Thickness Sander by S.R. Cook

*A low-cost alternative to handplaning*

#### 57 An abrasive solution by Curtis Erpelding

#### 59 The Scraper by Stephen Proctor

*A sharp burr makes shavings, not dust*

#### 62 Ripple Molding by Carlyle Lynch

*Reinventing a 19th-century mechanical marvel*

#### 64 Handscraped waves by Trevor Robinson

#### 65 Chainsawn Seat by Robert Erickson

#### 66 Guitar Maker's Inlay by William (Grit) Laskin

*All the peghead's a stage*

#### 70 French Polishing by George Frank

*Applying the ultimate finish*

#### 74 The Old Schwamb Mill by William Tandy Young

*A place for skilled hands in the Industrial Age*

#### 79 Woodworking at the Dairy Barn by Roger Holmes

*Ohio gallery mounts national show*

Re Keith Gansel's letter in *FWW* #57. Yes, it is tough trying to survive as a woodworker. If you're thinking of living in a \$200,000 house and driving around in a Mercedes, good luck. I also agree that some tools are overpriced, not necessarily for the quality of the tool but for the application. And as far as struggling for perfection, that's something mortal man only comes close to. I don't think there is a single artist or craftsman who hasn't looked at his or her masterpiece and said next time I'm going to make this or that change.

Gansel says he went to a woodworking show to learn something and came away disappointed. Although he was looking in the right place, he was looking for the wrong thing. I take a different view of new (or old) products. First, what is the principle behind the operation and second, what improvements or modifications would I need to make to adapt this tool to my needs? Next, I ask myself can I build this tool or gadget the way I want it for myself? After trips to the hardware store, I've made a 48-in. belt sander for less than \$20 and an 18-in. abrasive planer for \$25. *FWW* has run many excellent articles on how to make your own tools. Check the index.

It's not how accurate a tool is or how much it costs that makes the better job. It's the skill of the craftsman behind the tool that makes the difference. —*Jim Schumacher, Green Bay, Wisc.*

Regarding the arrow through the apple on p. 114 of issue #57. Why do you ask the readers how it got there? Won't William Tell?

—*Reid Samuelson, Eastford, Conn.*

Your articles on lathe building were interesting to me because I have just about finished restoring an ancient lathe that I found in a trash heap, minus many essential parts. Perhaps your readers would like to know of the following sources of parts for home-built lathes:

A good tool rest with a quick release can be gotten for about \$15 (Part #A801) from American Machine and Tool Co., Fourth and Spring Streets, Royersford, Pa. 19468. They also make many lathe accessories that can be used with their #1 Morse taper adapter, part #A783. A great source for many lathe parts is Sears. They have spur and cup centers for either #1 or #2 Morse tapers or to fit a plain 5/8-in. arbor. The latter would allow the home builder to skip the complicated machining that goes with Morse tapers. I still lack one thing for my lathe, which was made by the Greenfield Tap and Die Co. sometime in the dim past: a faceplate. The shaft size is kind of odd: 1 1/8 in. with 10 threads to the inch. I'd appreciate any suggestions from readers.

—*Carl Krumbardt, Chicago, Ill.*

David Sloan's article on the Amish woodworkers use of diesel power (*FWW* #56) was very interesting and informative. But I'm a bit confused by his closing paragraph that many of us are "pretending" to be in business by making "what we want to make . . . tying up countless hours of expensive labor in a precious one-of-a-kind piece that may not sell for months." Isn't this the same type of dedication and conviction that put the successful Amish "businessmen" where they are today?

—*Tim Tyner, Waukegan, Ill.*

I notice you had a lot on working without electricity in issue #56. One item we use here (with no electricity) is a square drive and/or Phillips bit made for electric drills. Put into a brace, it really speeds up installing a lot of screws and works much easier than a regular screwdriver.

—*Charles Collins, Virgin, Utah*

I was delighted to see on the back cover of issue #56, the story and pictures of the Merry Cemetery in Rumania, with its extraordinary wooden markers and their wonderful, simple poems. There is a strong and inventive popular tradition of

woodcarving in that country, of which the Merry Cemetery is only one example. It occurred to me your readers might like to know what the grave marker you depicted says. Here's a rough translation of the poem:

*Look well at me.*

*I experienced what no one experienced before.*

*I worked at the quarry.*

*A block of stone exploded*

*And broke my body to bits*

*And took away my life.*

*Hey, Ilea, my wife!*

*You called me too soon,*

*So I came next to you*

*And we shall both rest well.*

*But in our house in the village,*

*We left two little girls*

*Without mother, without father.*

*Almighty God, look after them*

*And help them all the time*

*So they will grow up and get married.*

*I took leave of my life*

*When I was 36 years old, in March 1975.*

*So long as I was among the living,*

*Pop Grigore was my name.*

—*M.U. Zakariya, Arlington, Va.*

I could not avoid the following reaction to the recounting of readers' responses on the question of what constitutes a "Doomsday tool kit" in your Jan./Feb. issue. Although I understand that readers are interested in the function of tools for forming wood, the underlying question that you imply, but fall short of, is this: What is the minimum technological basis for survival, plain and simple, given a total loss of the tools we know and love? The answer of course is not the triple-threat machete. As indispensable as it might be in providing severing, splitting and surfacing action, simply applying these to the production of a decorative item—say an imitation Brancusi from a small log—would not go far in the food-and-shelter department.

The really indispensable tools of both primitive man and of those suddenly deprived of technological accretions are the hands, which allow manipulation of natural objects and materials—hands that provide the brain with examples of processes that work. If this is indeed the case, it doesn't make sense to carry on a discussion of the merits of tying a Swiss Army Knife to your wrist before you fall asleep at night.

To illustrate the futility of relying on tools most familiar to our everyday life, I have decided to take with me into the perilous unknown a battery-powered Apex screwdriver. In case you think me shortsighted, I am also taking 200 lbs. of "D" cells, and—uh, let me see—did I pick up the Apex bits or the ones for the good ol' Yankee? No matter how bad things are when I get there, no doubt I will be able to find a hard rock to bash my head against when the big animals get too close and I can't find my Zippo. Perhaps I will meet machete-man on a treeless plain. We can console each other concerning our greater and lesser follies. —*G.L. Gilmore, Wilmington, Del.*

Using Greg Elder's vacuum bag press (*FWW* #56) I have just turned out three of the best veneered panels that I have ever produced. I should add that it was done expeditiously and without a whole lot of fuss, tools and equipment.

—*Frank Biewer, San Diego, Calif.*

I particularly enjoyed the article by Wayne Westphale: Designing Wooden Clockworks. I have two comments that may be of help to him and to your readers. Westphale mentions the use of nylon for bearings. Although this material has many properties

## JURIED WOOD SHOW

Slides are invited for an exhibition at  
the Nicolaysen Art Museum  
in December, 1986.

No geographic or other limitations for entrants.

Judging fee: \$5.00 per entry.

Deadline for receipt of slides: October 23, 1986.

Judges: Pershing Gieger of Casper, Wyoming  
and Steve Voorheis of Missoula, Montana.

For further information, contact:

**The Nicolaysen Art Museum**  
596 N. Poplar Casper, WY 82601  
(307) 235-5247

### HAMILTON ELECTRIC 3800 AIRPORT BLVD.

SALES & SERVICE  
512-472-5030  
AUSTIN, TEXAS

VISA and C.O.D. orders accepted

\$1290.00 EACH  
F.O.B. AUSTIN, TEXAS

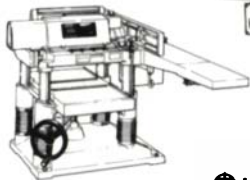

HITACHI

12" PLANER & 6" JOINTER  
(P100F - 12" PLANER) ONLY \$999.50

... Learn how the pros  
**Carve  
Realistic  
Feathers**

**...HOT TOOL!**  
17.95 Plus \$2.00 Postage  
MA Resident add 5%  
Dealer Inquiries Welcomed  
send today for brochures

**HOT TOOLS Inc.**  
P.O. Box 615-F · Marblehead, MA 01945 · 617/639-1000

## CUSTOM BEVELED MIRRORS

1/4" Clear Glass — \$2.50/sq. ft.\*  
Clear Mirror — \$3.50/sq. ft.\*

\*Plus Beveling Charge

BEVEL SIZE 1/2" 3/4" 1" 1 1/4" 1 1/2"  
PER INCH .10 .15 .20 .25 .35

Call Today Toll Free

**800-282-3100**

Sterling Equipment Company  
6700 Distribution Dr, Beltsville, MD 20705  
301-937-0333

# Money Machine.

This revolutionary invention, the *Paralok Table Saw Fence* makes cutting at least *seven times more accurate than any other fence... much faster... and is super simple to operate.*

#### Time was.

"We spent hours in the shop fighting with our rip fence and usually losing. Finally we retired it to a corner and resorted to a 1"x6" and pair of C-clamps. At least it was accurate. But crude and slow. We remember the test cuts, measuring front, blade and rear... taping to get everything in place, only to repeat it again for the next cut."

#### We set out to solve the problem.

Our ideas lead to the invention of the Paralok Fence. It took three years to perfect it. Now it is perfect and accurate. How accurate? Accurate in thousands of test cuts to .002" or less. This Paralok Fence saves time and materials and that spells *money*. We call it the *money machine*.

In the two years we've been marketing the Paralok Fence nationwide, we haven't talked to one customer who doesn't agree.

#### How it works.

The Paralok fence works on the same principle as a drafting table. Super strong aircraft cable (5/64", 49 strand) runs in a closed loop around 6 precision ground ball bearing pulleys located underneath the rails. The aircraft cable is engaged by the fence in both the front and rear. Move the front end 1/64" and the back goes 1/64".

*Single handed operation.* Lift up the handle and slide the fence down the rails with one hand. Use the combination of the tape mounted on the front rail and the vernier cursor next to the handle to set the fence at intervals of 1/64". You'll march right through your cutting list without having to stop the motor.

*Both the front and rear lock.* Two hefty locks, each with 750 pounds clamping pressure, independently lock the fence to the front and rear rails without squeezing the rails together. No distortion at the rear, no kickbacks due to binding the material.

#### Owners tell us.

"I'm a believer, I've had the Paralok on for a week now and we won't part company. The action is smooth, the parallelness is absolutely dead on, and it locks with a commitment to purpose that should be an inspiration to us all." G. B. Lee Baker, Redmond, Oregon

"The Fence is incredibly accurate... It has cut the time of any saw work by a measurable amount... I wish we had gotten this fence about four years ago." Bill Tongate, shop supervisor, Valley Cabinet & Trim, Ridgecrest, California.

#### More features.

The Paralok is easy to install, taking about 1 1/2 hours or less. (It can also be mounted with an auxiliary fence.) The Paralok is easy to remove for cross-cuts. It gives you long infeed and outfeed for better control. The fence is always perfectly parallel, even when being reset for the next cut. The anodized aluminum finish is tough, wear resistant and looks great. Because of such a smooth finish, material glides right through.

#### Fits almost all table saws.

The Paralok fits Rockwell-Delta, Powermatic, General, Wadkin-Bursgreen, Walker-Turner, Oliver, Jet, Sears Craftsman, and most others.

The important dimension is the depth of your table saw from front to rear. Then select from rails in six sizes: 4', 5', 6', 6'8", 8', 8'8". That is gross length. You decide how much you want to the right and left of the blade.

#### Standing behind our fence.

We're so confident you'll be more than pleased we offer a *five year warranty* on parts and labor for defective material or workmanship. And, if you're not satisfied with your Paralok, send it back in 30 days for a full refund.

#### For more information.

Give us a toll free call. We'll answer any questions and direct you to your nearest dealer (Dealer inquiries invited.) If we don't have a dealer near you yet, you can place your order direct.

We figure the Paralok Fence makes about ten million existing fences obsolete. And the real bonus is that it pays for itself — quick.

## Paralok™

Quintec Marketing

Post Office Box 736  
Newberg, Oregon 97132  
Call 1-800-423-9611  
Oregon & Alaska call 503/538-1875 collect

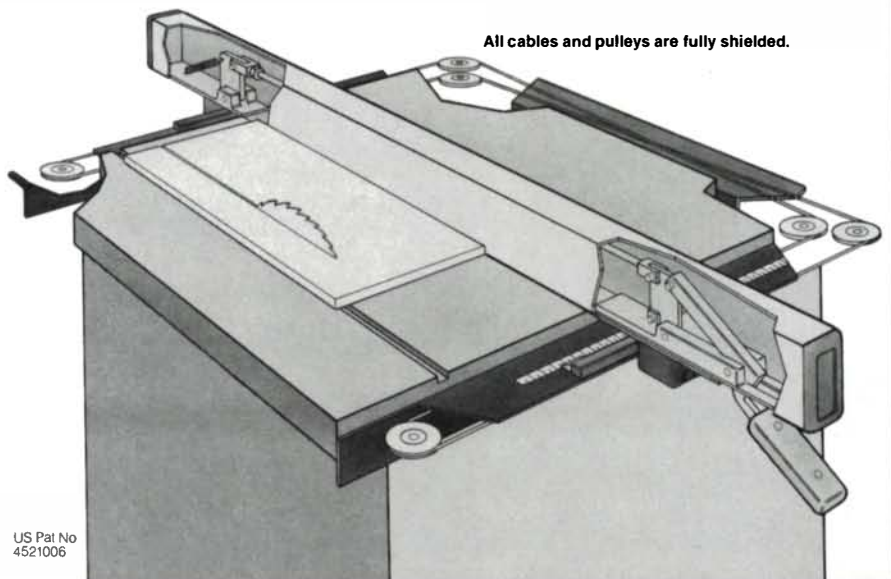

All cables and pulleys are fully shielded.

US Pat No  
4521006

to recommend it, it is not stable under high moisture conditions. May I suggest that he obtain a good materials handbook from the local library and evaluate the many newer materials for their suitability? He may be pleasantly surprised at the performance, availability and cost of some of these materials.

Some of your readers may want different pendulum lengths and would like to know how to conveniently calculate the various gear ratios needed. The equations below solve for the pendulum length of any gear ratio. I ran a program on my personal computer that solved for only those gear ratios that provided a pendulum length between 36 in. and 42 in. for the range of gears between 40 to 70 teeth for the wheels, between 6 to 10 teeth for the pinions, and between 30 to 60 teeth for the escapement wheel. Using the formula, any set of gear ratios will yield a solution. However, the ratios and/or the pendulum length may not be practical. For those of you who have access to a computer, I've included a program (in BASIC) that may prove useful.

The equations used to solve for the pendulum length are:

First solve for the period of the pendulum from:

$$T = \frac{3600 * Y1 * Y2}{X1 * X2 * 2 * E}$$

Then solve for the pendulum length:

$$L = \frac{T * T * G * 12}{Pi * Pi}$$

Where: G=acceleration of gravity (32.1726 ft./sec.<sup>2</sup>)

Pi=3.14159

10 G=32.1726

20 Pi=3.14159

30 FOR X1=40 TO 70

40 FOR X2=40 TO 70

50 FOR Y1=6 TO 10

60 FOR Y2=6 TO 10

70 FOR E=30 TO 60

80 T=3600\*Y1\*Y2/(X1\*X2\*2\*E)

90 L=T\*T\*G\*12/(Pi\*Pi)

100 IF L<=36 THEN 120

110 IF L>=42 THEN 120

120 PRINT X1,X2,Y1,Y2,E,T,L

130 NEXT E

140 NEXT Y2

150 NEXT Y1

160 NEXT X2

170 NEXT X1

180 END

—Lee Watkins, Mesa, Ariz.

WAYNE WESTPHALE REPLIES: I'll look into new materials as Watkins suggests, but feel safe with nylon for the time being, as it is proven and will certainly withstand any moisture conditions in which a wooden clock could run. The BASIC program is intriguing, but keep in mind that my pendulum is a complex or compound pendulum, due to the play in its leather hinge, and the mathematical results for pendulum length will prove only approximate.

In *FWW* #53, a letter from Harrie E. Burnell described a method of repairing a worn miter gauge by drilling the ends of the rail bar and tapping to accept a ¼-in. setscrew. My suggestion to further improve this fix is to utilize the nylon insert setscrews referred to as *Nylock*. These will virtually eliminate the loosening of the setscrew that attends usage on almost all vibrating tools.

These inserts may be found in all types of screws, bolts and nuts and are available through many industrial hardware suppliers. I've used these types of fasteners on most of my shop machinery as well as in automotive and marine applications and have yet to have any difficulty.

—Dean A. Carey, Soledad, Calif.

I read the article on tablesaws by Rich Preiss in #56 with great interest since I had recently purchased a tablesaw. After conducting a good deal of research, I had initially decided on the 10-in., 3-HP Unisaw. Unfortunately, the best price that I could obtain was approximately \$1,700, including tax and shipping.

As a hobbyist, I was reluctant to lay out that much, so I researched the imports. A call to Andreou Industries (advertised in *FWW* and listed in the table in the article) revealed that they were offering a 10-in. tablesaw for \$995, delivered. It had all the features I was looking for. Since they are located in my area, I paid a visit. To my great surprise, their model LS10 is of heavy duty cast-iron construction with a steel cabinet and weighs about 450 lb. The price and quality of this saw was a great find and I placed an order.

I'm more than satisfied with this machine and overjoyed at the price. I feel that *FWW* should give equal coverage to these imports in future comparisons and allow them to show or not show their stuff.

—Martin Laffey, Holbrook, N.Y.

In reviewing past issues of *Fine Woodworking*, I noticed on p. 4 of issue #36 a note from David Dolton regarding Lamello plate joinery. He uses a custom-ground ½-in. slotting cutter on a router to install the plates. The same effect is easily accomplished by stacking two ½-in. three-wing slotting cutters. This produces a clean 4mm slot without the expense of a custom cutter. Make sure the two cutters rest flat against each other and, depending on the manufacturer chosen, a very slight amount of metal might have to be removed with a fine file to allow a perfect nest.

—Omar Hansen, McKinley, Alaska

Re Simon Watts' basics of woodworking in #56. I'm surprised he didn't mention a hand grinder. Mine is 50 years old and still going. As a boy, I hung around a German man's shop, in Texas, that had no power except a one-lung gas engine for the table-saw. I have never used anything but a hand grinder for all edge tools. If you ever use a hand grinder with a white aluminum-oxide wheel about ¾-in. wide, you will never use anything else. I think Woodcraft still sells them.

—John W. Wood, Tyler, Tex.

I will be most surprised if I'm the only reader of your Jan./Feb. issue to comment on the photo on p. 42. The photo shows Russ Zimmerman at a grinding wheel, sparks flying, without his face shield pulled down into the protective position. Having seen the results of a grinding wheel breaking apart when the machinist had zero protection for his face or eyes, I cringe when I see this fatal error.

—George M. Englesby, Kennewick, Wash.

Recently I saw a sign in a laser optics lab that said *Do not look directly at laser with remaining eye*. Definitely a grabber. It suggests some more attention-getting wood shop signs, such as *Do not use remaining fingers as push sticks*. The one that means the most to me is a piece of graphic art in the back of my garage. It's a large fragment of a composite cutoff wheel that went AWOL while I was sawing angle iron on my Shopsmith. When I picked up the pieces (no harm done), the large sector was missing. I found it much later, piercing the pegboard wall. I leave it there as a reminder that safety is more than slogans. It involves habits like where to stand and equipment such as guards and shields.

—D. LeMay, Palos Verdes Estates, Calif.

I have several problems with David Sloan's report on the National Turning Conference at Arrowmont (*FWW* #56). Sloan's misconceptions about the display and his comments about "delightful irreverence" disturb me. As contemporary studio woodturning has evolved, it has moved out of the confines of utility and into the area of expressive freedom. Considering the history of woodturning of chair legs and newel posts, this has been

**SPECIAL  
30% OFF LIST**

# ON CARBIDE TIPPED ROUTER BITS

**PLUNGING BITS**  
45226



1/2" CUTTING DIA.  
1" CUTTING LENGTH  
1/4" SHANK

LIST \$13.50      SPECIAL \$9.45

**ROMAN OGEE**  
49204



1/4" RADIUS  
7/8" CARBIDE LENGTH  
1/4" SHANK

LIST \$35.00      SPECIAL \$24.50

**CORNER ROUND**  
49512



3/8" RADIUS  
1/4" SHANK

LIST \$27.00      SPECIAL \$18.90

**BEVEL TRIM**  
47202



25° BEVEL  
1/4" LENGTH OF CARBIDE  
1/4" SHANK

LIST \$17.10      SPECIAL \$11.97

**OGEE FILLET RAISED PANEL**  
54118



2-5/8" CUTTING DIAMETER  
5/8" CUTTING LENGTH  
1/2" SHANK

LIST \$95.00      SPECIAL \$66.50

**REVERSIBLE STILE & RAIL**  
55350



2 FLUTE FOR 3/4" STOCK  
1/2" SHANK

LIST \$112.00      SPECIAL \$78.40

EXPIRATION DATE 6/30/86

## More and More Furniture Manufacturers, Kitchen Cabinet Makers and Boat Manufacturers use "AMANA" Cutting Tools

For the past ten years Amana has combined years of manufacturing know-how with sophisticated technology to make the finest long-lasting, clean-cutting tools available to both large and small workshops across the United States.

Everyone says their tool is the best. At AMANA we say "Let the tool do the talking". Compare AMANA's Carbide Saw Blades and Router Bits to any others on the market and you will see why we say Amana is "A Bit Better!"

**SAVE UP TO 52%**

## SUPER SAW BLADE SPECIALS

Tool No.	Description	Diameter	Teeth	Bore	Grind	Special
586401	Sawbuck Blade	8"	64	5/8	TCG5° NEG.	\$50.15
696000	Cut-off Blade	9"	60	5/8	ATB	\$41.40
610600	Cut-off Blade	10"	60	5/8	ATB	\$39.65
610601	Laminated Sheets Blade	10"	60	5/8	TCG	\$39.65
610504	Combination Blade	10"	50	5/8	COMB	\$41.50
610800	Veneer Cutting	10"	80	5/8	ATB	\$61.50
*RM-438	General Purpose	4 3/8"	24	3/8" to 20mm	ATB	\$17.50

\*Fits both Makita 4200N and Rockwell 314



**AMANA TOOL CO.**  
"A BIT BETTER"

1250 Brunswick Avenue, Far Rockaway, NY 11691  
(718) 327-6100

FOR THE NAME OF YOUR NEAREST DISTRIBUTOR, CALL US TOLL FREE! 1-800/445-0077

no easy accomplishment. As turning acquires an aspect of preciousness—a Del Stubbs goblet could easily be crushed between two fingers, a David Ellsworth piece might easily be knocked over—it must be protected from accidents and theft. Plexiglas cases are a necessity, not an elitist device, as Sloan implies. It is not a snooty approach, which he refers to as the “shrine of Art,” but rather, a responsible, professional approach to exhibition in an accepted standard. The informality of the tabletop display added that hands-on dimension of which Sloan approved, but I noticed how shop-worn and scratched several pieces had become, and there were accidents as well.

To clear up another matter: James Prestini was not invited to the conference, nor was he aware of the presentation of the awards. He did not “not show up” as Sloan stated. Because of Prestini’s age, his busy schedule, and his retirement from turning since the 1950s, it was assumed he would not be able to attend, but we wanted to honor him as a surprise.

—Mark Lindquist, Henniker, N.H.

I suspect that the majority of those who read *Fine Woodworking* deserve to. What I mean is, they’re accomplished woodworkers who, either as amateurs or professionals, have paid their dues. On the other hand, I suspect that you also have a lot of other readers like me, who don’t have the slightest idea what you’re talking about most of the time. Not really. Not really. Oh sure, by now I can drop a few terms like “haunched mortise” and “blind dovetail” but have I ever chopped one out? Out of walnut, no less? Of course not.

You see, we’re pretenders, not woodworkers. The reason we’re pretenders instead of woodworkers is fear. Fear of entering that rarified atmosphere where the big boys hang out. Where the

mistakes are so glaring. Fear of butchering a hunk of walnut that goes for nearly five bucks a board foot. It’s safer down here with our No. 2 pine. My reason for writing this is to simply let you know we exist. Advanced work fascinates me, even when it’s way above my capabilities. Maybe it’s the vicarious pleasure of seeing something done extremely well. —Jay Fisher, Homewood, Ill.

Charles Dolan’s article on panel plane construction (*FWW* #55) contained valuable information for a woodworker who only occasionally, for the sake of various tools, has to dip into the forbidding realm of metallurgy. However, Dolan repeats an oft-heard assertion that old steels are emphatically not better than modern alloys. An experience I had a couple of years ago seems to raise questions about that claim.

Work on a historical building required tongue and grooving some antique Southern red pine. Anyone familiar with that wood knows it can be as hard as oak or birch. It was a common building material in the East until the last stands were logged off in the early decades of this century. The stock was 5/4 and required 5/16-in. tongue and grooves. Lacking a molding-head cutter, I borrowed my brother’s Record Multiplane.

After about five minutes of planing, the cutting edges would simply collapse—not merely go dull, but actually curl over. After a few resharpenings, followed by the edges collapsing again, I gave up and turned to a pair of wooden 5/16-in. tongue-and-groove planes that belonged to my grandfather, a West Virginia farmer/cabinetmaker who died in 1928, 15 years before I was born. They took some refurbishing, but once the planes were in shape they not only proved superior to the Multiplane in handling, but their irons had much more durable edges.

—Jim McConkey, Washington, D.C.

**Craft Summer**  
June 9 - July 18

Tagge Frid	Furniture Construction and Techniques
John Greven	The Art of Pearl Inlay
Geoff Eacker	Guitar Construction
Richard Butz	Woodcarving
J. Monteleone	Mandolin Construction

For more information contact:  
Geoff Eacker  
Rowan Hall, Miami University  
Oxford, Ohio 45056 Phone: 513-529-7395

One and two week workshops for students of all ability levels and media interests

**JUNE 9 - AUGUST 15, 1986**

WOOD - Bob Lockhart, Jere Osgood, Dale Nish, Rude Osolinik, Leo Doyle, Hap Sakwa, David Ellsworth/  
CLAY/FIBER/FABRIC/METAL/  
STAINED GLASS/PAPER/DRAWING/  
PAINTING/PHOTOGRAPHY

assistantships/scholarships  
graduate/undergraduate credit  
year round gallery exhibition schedule

**ARROWMONT**  
School of Arts and Crafts  
Box 567, Gallatinburg, TN 37738 (615) 436-5860

**KIRBY STUDIOS**

1986

FULL TIME SCHOOL OF DESIGN and WOODWORKING

ONE WEEK SUMMER WORKSHOPS

- BASIC WOODWORKING SKILLS
- VENEERS-VENERING & TORSION BOXES
- FRAME & PANEL IN FURNITURE
- CARCASE & DRAWER MAKING

Full information - available  
811 Atlanta Rd., CUMMING  
GEORGIA, 30130  
404-889-9823

**CRAFT Ed**  
PROFESSIONAL CRAFT STUDIES

Clay • Fiber • Metal • Wood

A two-year craft-career program  
college credit, loans, grants,  
financial aid, scholarships available  
September and January admission

Wood studies under the direction of Robert March,  
prominent American woodworker and designer.

**WORCESTER CRAFT CENTER**

25 Sagamore Road, Worcester, MA 01605 (617) 753-8183

**STUDY WOODWORKING IN THE NORTHWEST**

The Oregon School of Arts and Crafts offers a full-time individualized study program for woodworkers at all skill levels. Emphasis is on creative furniture design. Join us!

**OREGON SCHOOL OF ARTS AND CRAFTS**

8245 S.W. Barnes Rd., Portland, OR 97225  
(503) 297-5544



# Study Woodworking

at Bucks County Community College

- Intensive 2 year career program in furniture design and construction
  - Related courses in woodcarving, furniture conservation, basic woodworking skills
  - Accredited by National Association of Schools of Art and Design
- Call or write for program brochure.

Director of Admissions  
Bucks County Community College  
Newtown, PA 18940  
215-968-8100

## A NEW GENERATION Woodworking/Furniture Design at CCAC

Introducing new faculty  
Wendy Murayama and  
Gail Fredell Smith

Fall Classes begin  
September 1986

For admission to the BFA Program and other information contact  
California College of Arts and Crafts  
5212 Broadway, Oakland, CA 94618  
415-653-8118



Bill Sorensen  
Lounge chair, 1985,  
Walnut and plexiglass.

## Primrose Center

Academy of Furniture Design  
Steven Voorheis Design Studios

The foundations, technical and aesthetic, essential to excellence in craft and inspiration in design.

Write or call: PRIMROSE CENTER  
401 West Railroad St.  
Missoula, MT 59801  
(406) 728-5911

VA APPROVED

## LEEDS DESIGN WORKSHOPS FURNITURE PROGRAM

**LEARN** how to design and make fine furniture in wood as a career

**FULL TIME** one or two year professional training includes freehand drawing, mechanical drafting, hand and machine woodworking

**SPACIOUS** and excellently equipped workshops are alongside a wide variety of producing designer-maker businesses

**LOAN** financing available

For information write to ONE COTTAGE STREET, EASTHAMPTON, MASSACHUSETTS, 01027



**SAN DIEGO SHOW**  
SAN DIEGO  
CONVENTION CENTER  
Friday, May 30 - Noon-6pm  
Saturday, May 31 - 10am-6pm  
Sunday, June 1 - 10am-5pm

**ALASKA SHOW**  
WILLIAM EGAN  
CONVENTION CENTER  
ANCHORAGE, ALASKA  
Friday, June 27 - 5pm-9pm  
Saturday, June 28 - 10am-6pm  
Sunday, June 29 - 10am-5pm

EXHIBITS, DEMONSTRATIONS & SALES  
of  
EVERYTHING FOR THE WOODWORKER  
ADMISSION \$6.00  
FREE SEMINARS WITH ADMISSION

INCLUDING  
**THE DO-IT-YOURSELF SHOW**

For More Information: W.A.N.A., P.O. Box 706,  
Plymouth, New Hampshire 03264 - (603)536-3768

FOR TOURS OF ALASKA, HOTEL & TRAVEL PACKAGES,  
CONTACT PLYMOUTH TRAVEL (800)682-0135

THE BEST TOOL YOU'LL EVER BUY

# "WOODWORKING"

BY  
**IAN KIRBY**

- A TUTORIAL SERIES OF TWELVE BOOKS & TWELVE AUDIO TAPES
- WE INVITE YOU TO PREVIEW THE SERIES BY SENDING \$12.95 FOR THE FIRST BOOK AND AUDIO TAPE NORMALLY PRICED AT \$19.95 PER ISSUE
- SEND FOR INFORMATION AND SUBSCRIPTION DETAILS

1-800-LIGNUM-1

LIGNUM PRESS, Ltd.  
P.O. BOX 900217  
ATLANTA, GEORGIA 30329

# PENLAND?

Yes! This summer! Eight, one, two and three week sessions in wood from June 2nd to September 19th. Focus on techniques in wood turning and construction joinery—lathe, dove tail, bridle, miter, mortise and tenon—using standard shop machinery augmented by appropriate hand tooling. Participate in demonstrations, discussions and slide presentations.



Penland School • Dept. PR, Penland, NC 28765 • 704/765-2359

## Two more sawhorses

Here's a sawhorse with no metal parts to mar your work. These horses stack neatly, and they can also be knocked apart easily for storage or transport. The plywood legs are 8 in. wide at the top, though 6 in. will work if you want to cut down on weight. The only caution is that the sliding joints must be cut tight enough so that they must be driven with a hammer, or the horse will wobble. This construction is much stronger than it looks at first glance—I've put one sawhorse through the teenage student torture-test in my shop class, where it survives unbroken.

—Mark Blieske, Winnipeg, Man.

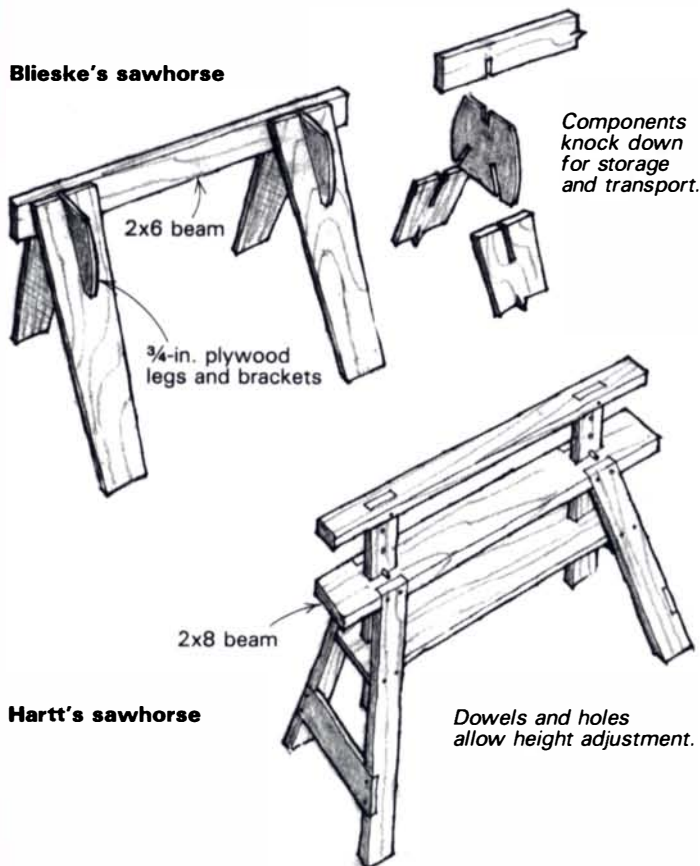

The adjustable-horse design shown above was originally published as a project in a 1958 *Delta*gram. I have put together several sets of these horses and find them to be valuable additions to any shop. With the extension down or removed, it is a sturdy saw-horse. With the extensions raised, two horses and a sheet of plywood make a handy layout table. The extensions can also be used to support long stock or plywood sheets when ripping on the table saw.

—Grover Hartt Jr., Dallas, Tex.

**Quick tip:** For those interested in trying tool making and heat-treatment procedures, a good (and inexpensive) source of high-carbon steel is the ordinary masonry nail, which can be shaped into a variety of small veiners, gouges, chisels, punches and embossing tools.

—Thomas Hamel, Houston, Tex.

## Raised panels on the jointer

You can produce panels with beautiful long-tapered bevels on your jointer, provided it has rabbeting capability. Build an out-board table from 3/4-in. plywood about 12 in. wide and as long as your jointer. Mount the table to your jointer or jointer stand so that the outside edge may be raised or lowered to produce the desired angle. The inboard edge of the table should be about 1/4 in. from the jointer's cutterhead.

Clamp a strip of wood to the jointer's fence flush with the jointer's bed to prevent the thin edge of the panel from sliding under. Three interrelated factors determine the shape of the

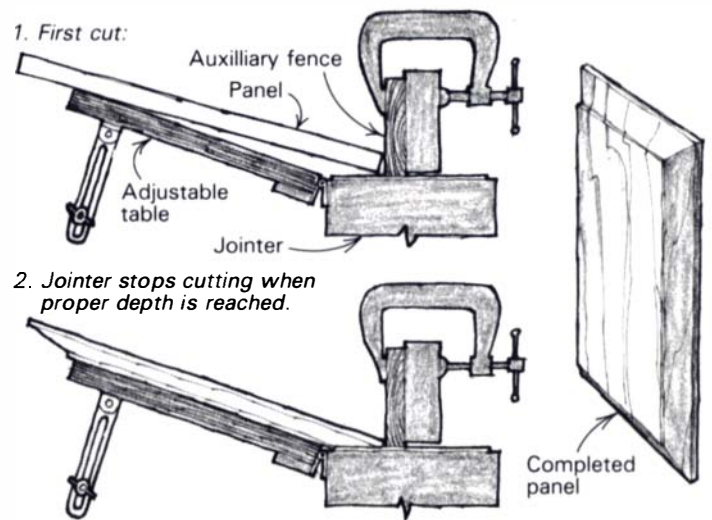

bevel. The depth of the shoulder on the panel is determined by the height at which you set the infeed table. The distance from the fence to the end of the cutterhead determines the width of the bevel. The thickness of the edge of the panel is determined by the angle of the outboard table, the width of the bevel and the depth of the shoulder.

When the setup is right, turn on the jointer and slide the panel over the cutterhead. Since the shoulder will ride on the jointer's infeed table when the proper depth is reached, you simply continue making passes until the jointer's knives stop cutting. Cut the two end-grain sides of the panel first so that tearout will be removed when the other two sides are cut.

—Norris S. White, Sellersville, Pa.

**Quick tip:** For grinding and honing spokeshave blades or other short, hard-to-hold irons, make an extension holder by sandwiching the blade between the cap iron and the iron of a full-size plane.

—Stephen Cohen, Woodstock, N.Y.

## Two storage containers



Recently Wilson began packaging tennis balls in unbreakable clear plastic containers with removable plastic lids. These containers make excellent storage bins for nails, screws, and the like. If you're not a tennis player, just scrounge the trash cans at your nearest tennis court or ask a local club pro to save some for you.

—R.B. Hurley, Williamsburg, Va.

Coffee cans with plastic lids are ideal storage containers for nails, etc., except for one problem—you can't tell what's inside. To remedy, fold the lid slightly and poke a nail in one side and out the other (like a safety pin in a baby's diaper) to leave a sample on the lid readily identifying the contents.

—Jeris Chamey, Ponca City, Okla.

**Quick tip:** Film canisters (35mm) are handy containers for smalls tacks, brads and the like. You can stick a sample through the lid. A block of wood with 1/4-in. holes will keep the collection in order.

—John Rocanova, Bronx, N.Y.

## Salvaging boards with loose knots

To salvage a board with an interesting but loose knot, fill the space around the knot with acrylic casting resin (available at hobby shops). First put tape on the back side of the knot and,



## Wood, Glass and You The natural combination

Imagine all the ways that you can work with the natural combination...and the incredible assortment of over 100 different shapes and colors of Mirrora Collection bevelled mirrors make any application possible.

Instantly applied, Mirrora bevelled mirrors create striking frames for custom woodworking designs.

There are unlimited possibilities for your woodworking creativity. A hand-held mirror, decorative wall decor and reflective panels in cabinets, highlight the beauty of your wood.

And, why not bring mahogany and Spicy Bronze Mirrora together...or a cool ebony with wonderful Shimmering Blue Mirrora. Floral Glass caters to the woodworking craftsman with glass and mirror in every size, thickness, color and edge finish need.

The natural combination. Mirrora and you.  
For more information, call or write Ed Reynolds at:

**FLORAL**  
Glass & Mirror, Inc.

Floral Glass & Mirror, Inc.  
895 Motor Parkway  
Hauppauge, NY 11788  
800 MIRRORA (Nationwide)  
800 647-7672 (Nationwide)  
516 234-2200 800 356-7253 (NY only)

Manufacturers Reps - Selected Territories Available.

### \* SANDPAPER \*

HIGH TECH Coated Abrasive Products

**BELTS: GRITS ASSORTED**  
UNLESS OTHERWISE SPECIFIED

1 x 30	\$.69 ea	3 x 24	\$.80 ea
1 x 42	.69 ea	3 x 27	.83 ea
1 x 44	.69 ea	4 x 21 <sup>3</sup> / <sub>4</sub>	.91 ea
2 <sup>1</sup> / <sub>2</sub> x 16	.73 ea	4 x 24	.94 ea
3 x 18	.74 ea	4 x 36	1.14 ea
3 x 21	.77 ea	6 x 48	2.98 ea
3 x 23 <sup>3</sup> / <sub>4</sub>	.80 ea		

OTHER SIZES ON REQUEST

**NO LOAD PAPER**

	50/pk	100/pk
180-A thru 400-A	\$10/pk	\$18/pk

**PRESSURE SENSITIVE ADHESIVE DISCS!**

GRITS ASSORTED UNLESS OTHERWISE SPECIFIED (MATERIAL-A/O-RESIN)

6	\$1.06 ea
8	1.99 ea
9	2.46 ea
10	3.05 ea
12	4.45 ea

OTHER SIZES ON REQUEST

- \* TEXAS RESIDENTS ADD 6% SALES TAX
- \* SHIPPING CHARGES ADD \$4.25
- \* MINIMUM ORDER \$25.00
- \* MASTERCARD, VISA OR CHECK

**SHEETS: ( 9 x 11 ) PRICE**  
ON REQUEST FOR GRITS NOT SHOWN

**CABINET PAPER**

	50/pk	100/pk
40-D	\$16/pk	\$30/pk
50-D	15/pk	27/pk
60-D	14/pk	25/pk
80-D	13/pk	23/pk
100-C	12/pk	21/pk
120-C	12/pk	21/pk
150-C	12/pk	21/pk

**WET/DRY PAPER**

	100/pk
220-A	\$23/pk
320-A	23/pk
400-A	23/pk
600-A	23/pk
800-A	23/pk

**FINISHING PAPER**

	50/pk	100/pk
80-A	\$9/pk	\$16/pk
100-A thru 220-A	\$8/pk	\$14/pk

\* JUMBO CLEANING STICK \*  
\$8.80

**ECON-ABRASIVES**  
P.O. BOX B865021  
PLANO, TX 75086

TELEPHONE (214) 422-2147

NO GIMMICKS JUST BETTER PRICES  
IF IT'S ABRASIVE WE GOT IT

- \* OTHER ITEMS \*
- \* WIDE BELTS
- \* ROLLS
- \* FLAP WHEELS
- \* PUMP SLEEVES

STATE OF THE ART Non-Directional Belt Splices

with the taped side down, pour acrylic into the knot until it mounds up on top. After the resin has cured, you can scrape or sand it flush. Any scratches will disappear under a coat of lacquer or varnish.  
—David W. Worden, Pontiac, Mich.

### Ferrule tool

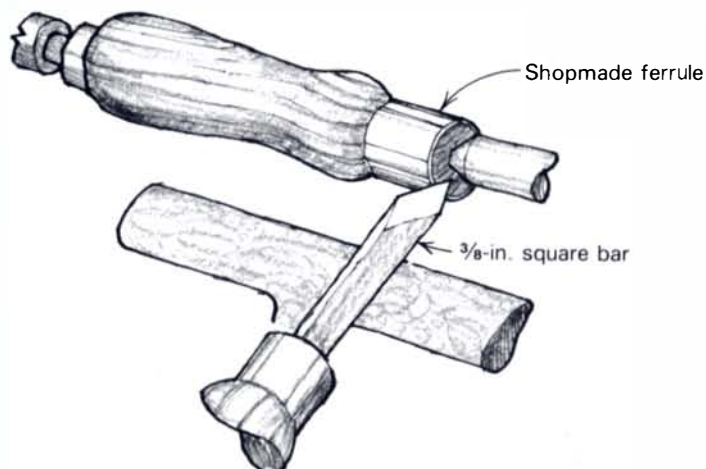

In *FWW* #45, James Dupler described a lathe tool for turning beads. It reminded me of the similar tool I use for truing the ends of shopmade copper or brass ferrules.

Make the tool from a short length of 3/8-in.-sq. tool steel—the blade should project no more than 2 in. from the handle to reduce vibration. Grind the end to a diamond-shaped face.

To use the tool, first turn a handle on the lathe. Remove the handle and drive a short section of copper tubing onto the end. Remount the handle, and with the toolrest close, bring the tool to the ferrule with the diamond face up. Roll the tool until the edge cuts, then proceed to level and round the end of the tubing.  
—P. W. Blandford, Stratford-on-Avon, Eng.

**Quick tip:** A nubby rubber doormat makes a great surface for holding small parts when power-sanding—the nubs grip like a thousand fingers.  
—Yvonne Ashmore, Grass Valley, Calif.

### Flip-down wheels

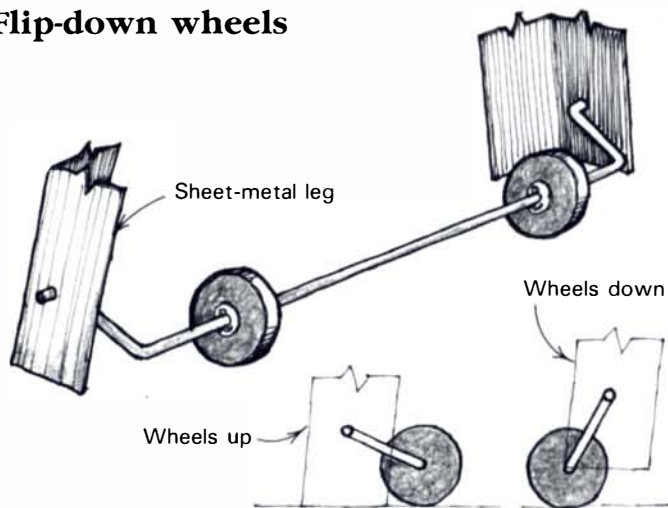

This simple flip-down axle fits tool stands with bent sheet-metal legs. First slide two wheels on a 3/8-in. steel rod, adding washers and cotter pins to keep the wheels in position. Bend the rod to a wide U-shape, as shown, and install the axle through holes in two legs. The holes should be located so that when you lift up the end of the stand and flip down the axle with your foot the axle will bear against the inside bend of the leg, effectively locking itself in position.

—Jeff Lormans, Dunedin, New Zealand

### Homemade wood-branding iron

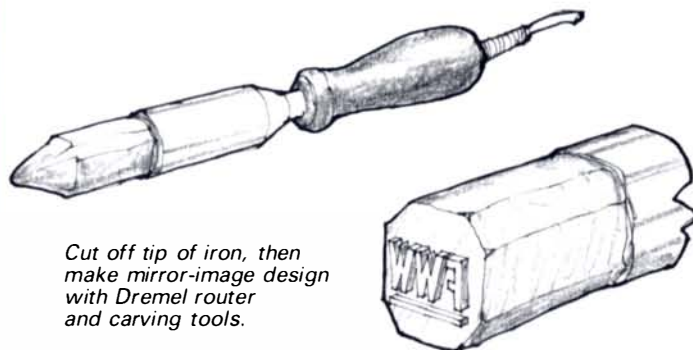

If you have always wanted one of those fancy branding irons to mark your projects, but felt they were too expensive, here's how to make one in your shop for next to nothing. First, scour the local flea markets to obtain a large electric soldering iron. Some of the older ones have copper tips a full inch across. The iron must work, but the condition of the tip is not important.

Cut about half the tip off to leave a large flat across the end of the iron. File this smooth. Trace your name or logo on the copper face, remembering that the design must be the mirror image of what you want to stamp on your projects. Rout around the letters to a depth of 1/16 in. with a Dremel tool, then use a small chisel or your woodcarving tools to finish up the design and add crisp edges. Copper is soft and will pare away easily—like carving lilac end grain.

If you can't locate an old soldering iron of sufficient size to handle your design, an alternative approach is to flatten the tip as above, but carve the design on a separate chunk of solid copper. Then use a torch and high-temperature silver solder to attach the plate to the iron.

To use the branding iron just let it heat up and press the copper against the wood. Presto! Your name is permanently charred in wood.  
—Wayne Spicer, Memramcook, N.B.

**Quick tip:** After much use, the tailstock of a Pony clamp will tend to slip because the edges of the four steel plates have become dull. To remedy this, reverse the plates so that a new edge is presented to the pipe.  
—Tom Ayers, Dover, Ohio

### Hole-spacing tool

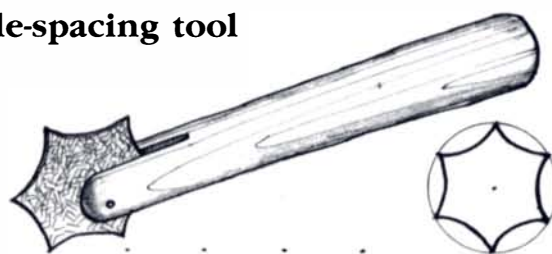

With this adaptation of a leather-stitcher's spacing tool you can quickly lay out a row of evenly spaced holes with surprising accuracy. First set a compass to the distance desired between holes and scribe a circle on 14-ga. sheet metal. Use the same compass setting to scribe six equidistant points around the circumference of the circle. Draw arcs between the points of the hexagon to create the six-pointed star shape shown in the sketch. Cut the star from the sheet metal, sharpen the points and mount the tool in a slotted handle using a nail for an axle.  
—Sandor Nagyszalanczy, Santa Cruz, Calif.

*Methods of Work* buys readers' tips, jigs and tricks. Send details, sketches (we'll redraw them) and photos to *Methods*, Fine Woodworking, Box 355, Newtown, Conn. 06470. We can acknowledge contributions only when the final decision has been made. We'll return those that include an SASE.

**#3 In a series of Techniques for Better Woodworking**

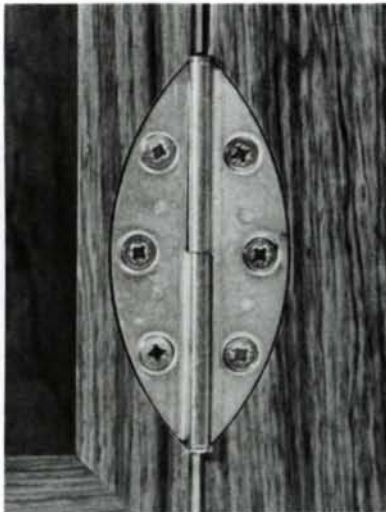

**Discover the secret to faster, neater Paumelle hinge installation**

Fine woodworkers recognize the Paumelle hinge as a hallmark of the best in European cabinetry. Did you know that the Paumelle hinge was originally developed for use with the Lamello system?

You too can learn how the functional beauty and classic simplicity of the Paumelle hinge will enhance the appearance and speed the assembly of your next piece. **Call or write Colonial Saw, PO Box A, Kingston, MA 02364 (617) 585-4364 for your free copy of Lamello Techniques #3.**



A Small Tidewater Salt Box House  
**"SALT SHAKER"**  
 Main Bldg: 26'-0" Deep, Full Cellar  
 1<sup>st</sup> Fl: Living Dining Area With Fireplace And Grill, Kitchen,  
 2<sup>nd</sup> Fl: Bed Rm. With Fireplace And Bath  
 Rear Wing: 16'-0" Deep, Crawl Space Below, 1<sup>st</sup> Fl: Bed Rm. With Bath, Side Entry And 1/2 Bath.  
**PLANS \$22.00**

Early American Gambrel, 26'-5" x 21'-4"  
**"DOUBLE DUTY"**  
 Studio Apartment With Living-Sleeping Area, Kitchen And Bath, Over A 2-Bay Garage  
 OR  
 A Center Chimney, 2-Story Residence With 2 Bedrooms, 2 1/2 Baths, Living-Dining Area, Kitchen, Fireplace, Grill, And Woodstove  
 BOTH Arrangements Included  
**PLANS \$18.00**

An Office/Garage Of Early American Heritage  
**"HOME OFFICE"**  
 A Two-Car Garage 22' Deep, 25' Front, With Inside Stairs To Second Floor Office Space, Studio, Work Area, Etc.  
 Skylights In Rear Roof To Upper And Lower Floors  
**PLANS \$15.00**

A Flexible Early American Design  
**"CARRIAGE SHED"**  
 4 Depths At Side: 20', 21'-4", 22'-6", & 24'-0"  
 1, 2, 3, Or More Car Spaces  
 2 Door Types, Shop At Side, Etc.  
 2<sup>nd</sup> Fl.: Studio, Playroom, Storage, Skylights In Rear Roof  
 Complete Construction Details For The 4 Depths And 4 Optional Front Arrangements  
**PLANS \$12.00**

ELI TOWNSEND & SON, INC.  
 P.O. BOX 351-WV  
 CLINTON, CT 06413

Plans Are Reproducible And By Req'd Prof'l Entry (Post Paid)

From Europe The Ultimate in  
**HISTORIC SHIP MODEL KITS.**  
 Plank-on-frame Construction

World famous kits from Artesania Latina, Mamoli, Mantua/Sergal and more: large, magnificent replicas (many over 4 feet long!) with beautiful walnut and mahogany planking, fittings and details exquisitely cast in bronze, brass and rare hardwoods. Large scale plans, step-by-step instructions, all materials included.

Send for 88-pg. full-color catalog only \$1.00

**MAIL THIS COUPON TODAY!**

**MODEL EXPO, INC.** Dept. FW-56S  
 23 Just Road, Fairfield, N.J. 07007

Please send me a full colorship model catalog. \$1.00 is enclosed.

Name \_\_\_\_\_  
 Address \_\_\_\_\_  
 City \_\_\_\_\_  
 State \_\_\_\_\_ Zip \_\_\_\_\_

**LUREM**  
 Universal Woodworkers  
*"for the woodworker who needs more shop space."*



C. 260N

Lurem is the world leader in design and manufacture of Universal Woodworking Machines with over 35 years experience in building this type of equipment. They are built from casting for reliability, and will sustain hard and continuous operation. Standard features include tilting arbor saw, jointer, auto feed thickness planer, shaper, horizontal drill mortiser, and sliding carriage for cross cutting and tenoning. Four models available with jointer/planers from 8" to 16" wide.

Send \$1.00 for Brochure

**HAPFO**  
 Copying Lathes

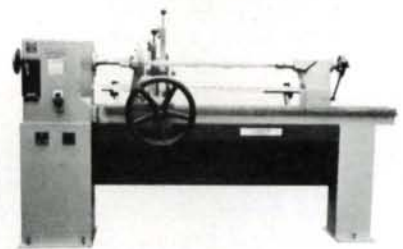

AP 5000-M

Wood copying lathes of advanced design for custom turning a wide variety of parts, especially long thin parts such as those required in stair and chair production. An adjustable ball bearing back rest guided directly in front of the cutting tool makes this possible by reducing vibration of the workpiece and the part is completed in **ONE PASS**. HAPFO lathes, made in Germany, are available in a variety of sizes from 55 inches to 12 ft. between centers, in manual feed, electric motor drive, and hydraulic operation.



Send \$1.00 for Brochure

Int'l. Woodworking Equip. Corp.  
 3816 IH 35 South, P.O. Box 1551  
 San Marcos, Texas 78667  
 512/392-0123

## Photos create upscale problems

*I want to reproduce a Newport-style blockfront from a magazine photograph. I know the height/width/depth of the piece, but I need help scaling the rest of the dimensions from the photograph.*

—R.W. Moulands, Havertown, Pa.

**Norm Vandal replies:** Scaling up a furniture design from a photograph isn't difficult, provided you have a clear perspective photograph of the piece and know its height, width and depth. If you don't know these basic dimensions, you will have to contact the photographer, check a reference book or museum, or measure a comparable piece before you can begin. In addition, it also helps if the piece you want to scale is fundamentally rectangular. Odd angles and curves aren't easy to figure out.

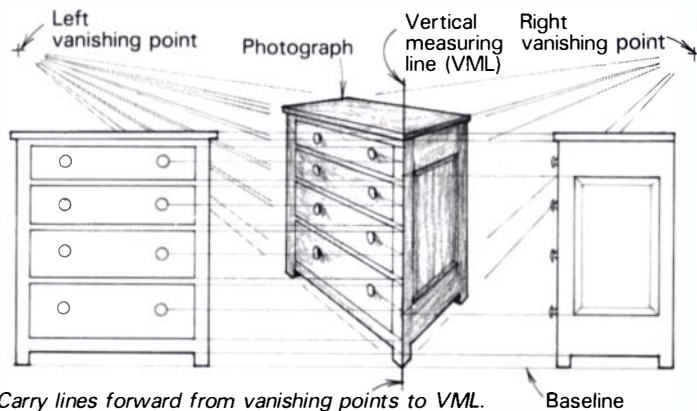

Most of the problems encountered in working with photographs have to do with perspective. The photograph may trick your eye, unless you clearly define the planes of the piece of furniture. Start by taping the photograph to a large sheet of paper and drawing a vertical line on the foremost vertical corner of the piece, as shown on the chest above.

This is the vertical measuring line (VML), which will be used for marking all vertical measurements. Where the piece touches the floor at the bottom of the VML, extend a baseline on either side of the VML at 90°.

To scale up the photograph, you must first develop a ratio between the measuring increments (millimeters or  $\frac{1}{16}$ -in. usually) you intend to use on the photo and inches on the full-size piece. To do this, put a ruler on the VML and measure the height of the chest. If, for example, the chest measured 58mm tall in the photo and the original piece is 36 in. tall, then the scaling ratio is 36 divided by 58 or 0.62 in./mm. Now when you lay your ruler across the height of a drawer and it measures 8mm, the same drawer on the completed piece will be 8 times 0.62 or 5 in. Once calculated, this scaling ratio will allow you to scale up even minute details such as brasses and moldings. A pocket calculator is a must to speed the process.

Next, use the scaling ratio to calculate the dimensions of and draw in the outline of a face view and a side view on either side of the photograph. For example, if the chest is to be 30 in. wide, then 30 divided by 0.62mm/in. gives a scale width of 48mm. Similarly, if the chest is 20 in. deep, then 20 divided by 0.62 gives a scale depth of 32mm. Carefully mark these measurements on the paper and then outline the face and side views.

Some pieces, such as slant-front desks or step-back cupboards, have vertical lines on two or more planes. Here you'll have to carry the points on this second vertical plane forward to intersect the VML. You can do this fairly accurately by locating the two vanishing points of the photograph by extending lines back from the top and bottom edges of the piece, as shown. The lines will intersect at the vanishing points, which are typically a foot or two outside and a few inches above the photograph. After you have located each vanishing point, draw a line from it through the second vertical plane to intersect the

foremost vertical line. Now you can draw this second plane horizontally on your drawing. In essence the VML becomes a story stick for the entire piece of furniture. These measurements may then be easily carried to the front and side views with horizontal lines. Without making a scale drawing, it's impossible to check your dimensions prior to constructing the piece. No system is foolproof. You will have to depend on a good eye and intuition to eliminate errors and come up with a good working drawing.

[Norm Vandal makes period furniture in Roxbury, Vt.]

## Saw blade burns bevels

*I'm making a cherry bedroom suite and all the drawerfronts are beveled on a tablesaw. How do I avoid blade burns on the bevels. If I can't avoid them, what is the best way to remove them? I've been using a cabinet scraper, but there has to be a better way.*

—Mark Blieske, Winnipeg, Man.

**Simon Watts replies:** Burning can be a problem whenever you make this kind of cut. The best way to minimize burns is to use a new or recently sharpened carbide blade—a 60- to 80-tooth ATB would be fine—and be sure that the sides of the blade are clean. Remove any gummy deposits with oven cleaner. With the panel face down on the tablesaw, make a shallow cut on all four sides to outline the raised panel area and mark the top of the bevel. The bevel cut intersecting with this cut frees the waste. After adjusting the saw fence and setting the blade at the proper angle, cut the beveled section. It might help to make a rough cut first to remove most of the waste, then make a light finishing cut. Push the wood briskly through the saw. The more you linger, the more likely you are to get burns. I don't know how big your panels are, but it often helps to screw an extra high auxiliary fence to the regular metal saw fence, to ensure that the stock is truly vertical when you saw the bevels. I find a cabinet scraper is the best way to clean up the surfaces. If you don't object to tool marks, you could try a shoulder rabbet plane.

[Simon Watts is a cabinetmaker, teacher, and boatbuilder in San Francisco and Nova Scotia.]

## Wood movement warps tabletop

*I recently made a solid cherry drawleaf dining table. The 38-in. by 48-in. top is free-floating and assembled from edge-glued  $\frac{3}{4}$ -in.-thick, 6-in.-wide boards. Although the top was perfectly flat when it was made, it now bows up in the middle during the summer, and in the winter the center bow disappears but the ends cup up. This movement is quite noticeable and annoying. I suspect it happens because the top surface is more exposed to the atmosphere and more susceptible to moisture changes than the bottom. Is there any way to modify the top to minimize this movement. If not, what should I do to prevent the problem on my next table?*

—Paul Newton, Bridgewater, Nova Scotia.

**Jim Cummins replies:** Your problem is a common one, and there's no easy solution. In any flatsawn board, the annual rings of the tree form a series of arcs, visible on the endgrain. In simplest terms, these arcs tend to straighten out when the wood dries out, and when the wood absorbs moisture the arcs tend to return to their original shapes.

A single wide board, therefore, cups as it dries, with the cup on what was the outer surface of the tree, and it cups the other way when it gets wetter. There is no good way to stop moisture from gradually entering and leaving wood—a good three-coat finish slows the process down, but over the season the wood will change its moisture content to come in balance with the average relative humidity of its environment. A tabletop glued up from a series of boards will behave the same way as a single board if the annual rings all arc in the same

# Woodworker's Supply

OF NEW MEXICO

5604 Alameda N.E., Alb., N.M. 87113

1-800-645-9292

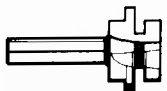

### Carbide-Tipped Tongue And Groove Bit

Great for glue joints or panel edges. Sturdy 1/2" shank. Run one piece face up and the other face down to make the interlocking joint. Handles thicknesses from 1/2" to 1". Overall length is 3" and large diameter is 1 1/8". 132-309 \$49.50



### Easy Picture Hanging With Keyhole Bit

Plunge the bit and it bores a 3/8" hole. Push it forward and the bottom of the hole stays at 3/8" but the top of the slot is 1/16" to form a lip enabling you to hang pictures or plaques flush to the wall with no wires or hardware. Shank is 1/4" and overall length is 1 1/16".

132-054	High Speed Steel Keyhole Bit	\$13.25
132-307	Carbide Tipped Keyhole Bit	\$19.95

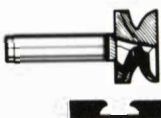

### Carbide Drawer Pull Bit

End cutting allows plunging and also gives a clean finish to the bottom of the slot. Sturdy 1/2" shank. Overall length is 2 3/4" and the large diameter is 1 3/8". For material 3/4" or thicker. 132-310 \$52.50



### Carbide Lock Miter Router Bit

When positioned properly, both pieces can be run without moving the bit. One piece is run horizontally and the other is run vertically. Thick carbide tips and massive backing insure smooth cutting. For material from 1/2" to 1" thick. 132-288 \$149.95

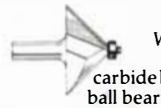

### Carbide Big Chamfer Bit

With a 1 1/16" cutting length you can miter edges with this two fluted carbide bit. Sturdy 1/2" shank and shielded ball bearing pilot. Large diameter is 2 1/2" and overall length is 3". 132-106 \$104.35

## FINEST QUALITY CARBIDE BITS 100% SATISFACTION GUARANTEED

### Raised Panel Doors With Your Router

Big, thick carbide tips and sturdy 1/2" shanks. The stiles and rails are cut using the same bit, by reversing the cutters and using the supplied spacers. The ogee panel bit features a non-marring ball bearing pilot and allows a 1 1/16" horizontal depth of cut. For use with 3/4" stock.

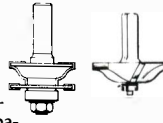

132-300	Stile/Rail Bit	\$ 98.50
132-112	Ogee Panel Bit	\$106.50
Buy both and save		\$189.00



### Carbide 3-in-1 Bit Makes 3 Cuts In One Pass

Makes straight side, rounded corner and flat bottom all in one pass. Great for shaped boxes and trays. Shank is 1/2". Height of carbide is 1/2". Radius is 1/8". Overall length is about 2 1/4".

132-113	7/16" Diameter	\$17.85
132-114	3/4" Diameter	\$22.50



### Carbide Classical Bit With Ball Bearing Pilot

Great for edging tables or panels. Shielded ball bearing pilot is non-marring for high speed routing of decorative designs. Reinforced with a heavy duty backing to insure long lasting, reliable performance. Shank is 1/4", overall length is 2 1/2" and the carbide is 3/16" high. 132-055 \$39.50

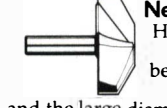

### New Carbide Raised Panel Bit

Has no bearing so you can make the tongue of your panel to fit better. Classic 30° design. Sturdy 1/2" shank. Overall length is 3" and the large diameter is 2 3/4". For stock from 3/4" to 1 3/8" thick. 132-308 \$69.50



### Carbide Tipped 30° Raised Panel Bit

Thick carbide tips and shielded ball bearing pilot. High axial and radial hook angles mean fast, clean cutting. Sturdy 1/2" shank. Overall length is 2 1/2". Height of carbide is 1/2" and the large diameter is 1 3/8". Horizontal depth of cut is 1/16". Great for edging plaques and signs as well as panels. 132-036 \$38.50

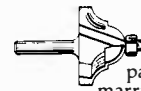

### Carbide Double Roman Ogee

An elegant design for edging panels and plaques. Shielded, non-marring ball bearing pilot. Shank is 1/4". Thick carbide tips.

	Lg. Dia.	Rodius	Carb. Lgth.	O.A.L.	
132-104	1"	3/32"	3/8"	1 3/4"	\$37.00
132-105	1 3/8"	1/4"	7/8"	2"	\$41.15



### Use Splines Instead of Dowels

Fast cutting, 3 wing carbide tipped bit for cutting grooves 1/2" deep. Using splines reduces splitting and also aligns edge glued boards. Non-marring shielded ball bearing pilot. Make sure this bit seats in the collet before running. Overall length is 2 3/8" and large diameter is 1 7/8". The 3/64" size is perfect for installing T-molding.

	Spline Cutter	Shank	
132-038	1/4"	1/4"	\$26.90
132-138	1/8"	1/4"	\$25.50
132-238	1/4"	1/2"	\$26.90
132-239	1/8"	1/2"	\$25.50
132-053	3/64"	1/4"	\$27.50



### Solid Carbide 4-Flute 1/4" Straight Bit

The smoothest cutting bit I've seen. Great for sign work or finish cutting edges. Smooth end cutting. Upright design pulls router to work for consistent results. Cutting edge is 3/4" and the overall length is 2 1/2". Shank is 1/4". 132-311 \$39.50

All bits are top quality and suitable for production work. Carbide thickness allows up to 15 regrinds. Reinforced backing material means long-lasting reliable operation. High hook angles and open gullets for fast chip clearance and open gullets for fast chip clearance and easy cutting. Shielded ball bearing guides enable high speed, mar-free routing. Precision ground shanks are hardened and tempered.

# Woodworker's Supply

OF NEW MEXICO

1-800-645-9292

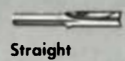

Straight



V-Groove



Core Box



Chamfer



Cove

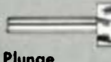

Plunge Classical

#### STRAIGHT BITS — 1/4" Shank

	Cut Dia.	Cut Lgth.	O.A.L.	
132-001	1/4"	7/8"	2"	\$ 8.75
132-049	3/16"	3/4"	2 1/4"	\$ 9.75
132-002	3/8"	1"	2 1/4"	\$ 8.75
132-003	1/2"	1"	2 1/4"	\$10.05
132-007	3/8"	1 1/4"	2 1/4"	\$10.60
132-004	3/4"	3/4"	2 1/4"	\$10.75

#### STRAIGHT BITS — 1/2" Shank

132-005	1/2"	2"	3 1/2"	\$13.50
---------	------	----	--------	---------

#### V-GROOVE - 90° — 1/4" Shank

132-009	1/4"	3/4"	2"	\$11.10
---------	------	------	----	---------

#### CORE BOX — 1/4" Shank

132-026	1/4"	3/4"	1 1/2"	\$17.35
132-027	3/8"	1"	1 1/2"	\$18.85
132-028	1/2"	1 1/2"	1 1/2"	\$20.30
132-029	3/4"	1 3/4"	1 1/2"	\$23.65

#### CORE BOX — 1/2" Shank

132-102	1"	1 1/4"	2 1/4"	\$31.95
---------	----	--------	--------	---------

#### CHAMFER - 45° — 1/4" Shank

	Cut Carb. Lgth.	O.A.L.		
132-024	3/8"	1 1/4"	2"	\$19.45

#### COVE — 1/4" Shank

	Cut Rad.	Cut Dia.	Lgth.	O.A.L.	
132-050	1/4"	1/2"	3/4"	1 1/4"	\$21.75
132-015	3/8"	3/4"	1 1/4"	2"	\$22.45
132-016	1/2"	1 1/4"	1 1/4"	2 1/4"	\$23.90

#### PLUNGE CLASSICAL — 1/4" Shank

	Cut Dia.	O.A.L.	
132-040	1/2"	1 3/4"	\$21.30
132-041	3/4"	1 3/4"	\$29.25



Corner Round

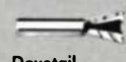

Dovetail



Rabbeting



Roman Ogee



Plunge Ogee

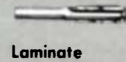

Laminate Flush Trim

#### CORNER ROUND — 1/4" Shank

	Cut Rad.	O.A.L.	
132-042	3/16"	1 3/16"	\$21.05
132-018	1/4"	1 1/8"	\$19.85
132-043	3/8"	2"	\$25.10
132-019	3/8"	2 1/4"	\$20.00
132-020	1/2"	2"	\$21.15
132-021	Ball bearing to convert corner round to beading bit 1/8" OD		\$ 5.25

#### CORNER ROUND — 1/2" Shank

132-044	3/4"	2 1/4"	\$41.00
---------	------	--------	---------

#### DOVETAIL - 14° — 1/4" Shank

	Cut Dia.	Cut Lgth.	O.A.L.	
132-012	1/2"	1/2"	1 1/4"	\$11.00

#### RABBETING — 1/4" Shank

	Cut Depth	Cut Lgth.	O.A.L.	
132-017	3/8"	1/2"	2 1/8"	\$19.45

#### ROMAN OEGEE — 1/4" Shank

	Cut Rad.	Cut Lgth.	O.A.L.	Di.	
132-022	3/32"	3/8"	2 1/8"	1 1/4"	\$23.50
132-023	1/4"	3/4"	2 3/8"	1 3/8"	\$26.35

#### PLUNGE OEGEE — 1/4" Shank

	Cut Dia.	Cut Lgth.	O.A.L.	
132-045	3/8"	3/4"	1 1/4"	\$14.30
132-046	1/2"	1 1/4"	1 1/4"	\$19.25
132-047	3/4"	1 1/4"	1 1/4"	\$28.00

#### LAMINATE FLUSH TRIM — 1/4" Shank

	Cut Lgth.	Cut Dia.	O.A.L.	
132-048	1"	1/2"	3"	\$12.60
132-220	1"	3/8"	2 1/4"	\$14.00

Ship To \_\_\_\_\_

Address \_\_\_\_\_

City \_\_\_\_\_ State \_\_\_\_\_ Zip \_\_\_\_\_

Qty.	Description	Product #	Price	Total

Woodworker's Supply Subtotal  
OF NEW MEXICO Shipping  
 5604 Alameda NE • Alb., NM 87113 TOTAL  
**1-800-645-9292**

Check or Money Order  MasterCard  VISA

Card Number \_\_\_\_\_ /\_\_\_\_\_/\_\_\_\_\_  
 Exp. Date \_\_\_\_\_ Thank You

Signature \_\_\_\_\_ For Your Order!

Packing And Insured Delivery — Must Be Included  
 \$ 0.01-\$14.99 \$3.00  
 \$15.00-\$29.99 \$4.00  
 \$30.00-\$49.99 \$4.75  
 \$50.00-\$300.00 \$5.25  
 Over \$300.00 FREE

direction. I think this is your problem, not the fact that one side on the top may dry more than the other (although this too may have something to do with it, I would expect both sides to average out over the course of a couple of weeks at the most, provided the top and bottom surfaces have the same number of coats of finish.)

You can avoid the problem in two ways: Use veneered plywood (the best solution). Or, use quartersawn lumber, with the annual rings running as close to 90° from one face of the board to the other. Quartersawn wood will have much less of a tendency to cup. A third solution comes with its own problem. If you alternate the arcs of the annual rings from board to board in the top, the separate small cupping of the individual boards will average out instead of adding up. The tabletop will remain relatively flat on the whole, but it will show a slight washboard effect. Inspect your tabletop to see if you have most of the annual rings going in the same direction. If you can stand the idea, rip the top into the boards you began with, arrange the boards to alternate their ring directions, adding another board somewhere to make up for all the kerf waste, then reglue and refinish the top. If you will be doing much hand-planing, take great care to figure out the grain direction in the individual boards before glueup. Solution number four would be to move to a part of the world where the climate never changes. I'd personally prefer a fifth possibility: enjoy the table as it is, it probably has many more virtues than vices and should be allowed its eccentricities.

[Jim Cummins is an associate editor of *Fine Woodworking*.]

### Paying for shrinkage in kiln

*I recently purchased lumber from a dry kiln. The amount of dried lumber I received totaled about 6% less than the invoiced amount. The kiln operator said it was standard practice to charge 6% to 8% extra to account for shrinkage in the kiln. Is this actually an industry-wide practice or has my local dry kiln gone renegade.* —George Majka, Pomona, Ill.

**Jon Arno replies:** The nominal dimensions of lumber are based on its green measure, but I'm unaware of any specific formula or "standard practice" for allowing for kiln shrinkage when the load is sold. However, I don't see anything deceptive in a kiln operator selling a 100-bd.-ft. "kiln load" on the basis of the wood's green volume, nor is 6% shrinkage unreasonable. In addition to shrinkage, the difference between nominal and actual measure also depends on how much wood is lost in milling or surfacing the stock.

When I buy hardwoods rough or surfaced on two sides (S2S), I give the mill the benefit of the doubt for about 1/2 in. to 1 in. of width loss to shrinkage and then calculate the linear footage on the down side. In other words, I consider a 3/4-in. board measuring 7 1/2 in. wide and 98 in. long to be an 8-ft.-long 1x8. In my experience, mills tend to be generous in figuring board footage. The real art of bargaining rests in how you haggle over the price per foot.

[Jon Arno is an amateur woodworker/wood technologist living in Brookfield, Wisc.]

### Follow-up on moisture meters

I built the wood moisture meter Rick Liftig described in #53, pp. 48-50, but modified it as shown to add devices for testing the batteries and checking meter calibration. For the battery reading, I added another scale to the top of the meter dial. This scale is divided into 20 equal parts, each part equaling 1 volt. To calibrate this scale, you must first measure the actual voltage of your two 9-volt batteries. With two new alkaline batteries, a voltmeter should show a total of 18 volts to 19 volts. Once you know the voltage, depress switch SW3 and adjust the potentiometer R21 until the needle reads the same as your voltmeter.

After that, all you have to do to check batteries is press switch SW3 and read the voltage off the meter. When the voltage drops below 14 and 15 volts, you should replace the batteries.

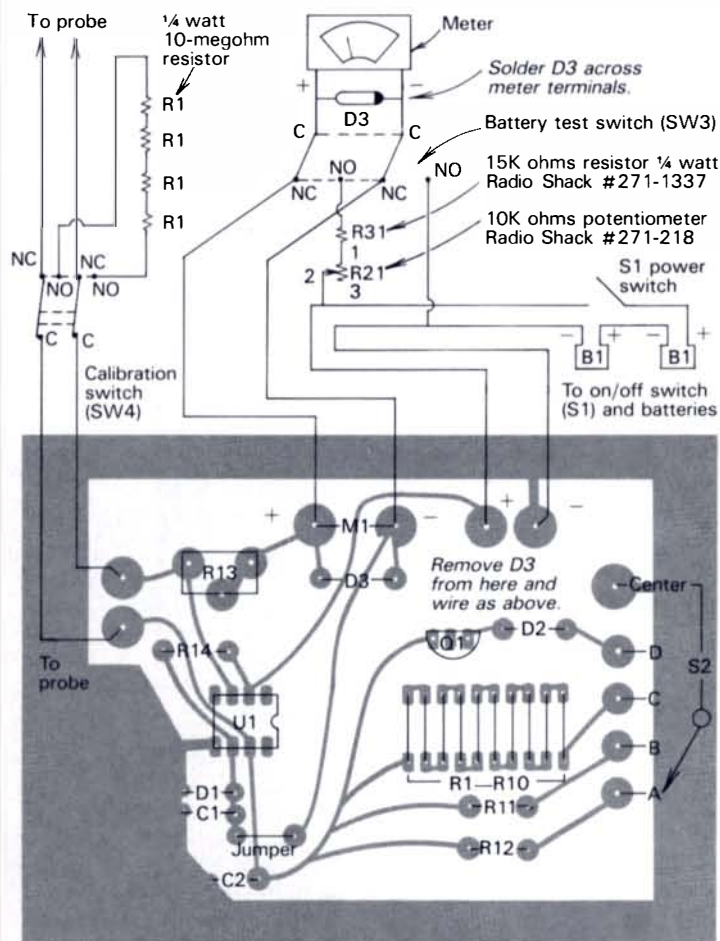

The calibration switch checks if the meter is functioning properly. Here, set the range switch S2 to scale C, then press the calibrate button SW4. The meter should read 14%. If it doesn't read 14%, it is either not calibrated (adjust potentiometer R13) or it is malfunctioning.

In addition to the parts used by Liftig, I added the potentiometer and resistors shown above. The battery check and calibration switches are push button, double pole/double throw devices.

In making meters for myself and two friends, I also found the best material for making probe points comes from high-carbon steel masonry nails. —Charles J. Bond, Palmyra, N.Y.

### Reader exchange

... I would like to sell a few extra issues of *Fine Woodworking*—Volume 1, #1 through #6, and Volume 2, #1 and #2. I'd like \$5 each, postpaid or \$35 for all eight. —Don Garlow, 716 Rivercrest Dr., Sacramento, Calif. 95831.

... I would like information on corporations, manufacturers and other institutions offering in-depth technical information and hands-on training in professional wood finishing, especially lacquering. —Subhakara Csenge, Topsham, Me.

... Does anyone have a manual and parts list for a Walker Turner shaper, serial #9S240. I have instructions and parts list for an Atlas 10-in. tablesaw, #3160, 3180, 3190, which I would be happy to share with anyone sending me a stamped self-addressed envelope.

—Doug Pawley, 86436 Needham Rd., Eugene, Ore. 97405

Send queries, comments and sources of supply to Q & A, *Fine Woodworking*, Box 355, Newtown, Conn. 06470.



# Fine Tools For Less!



## 1" 2-Speed Spindle Shaper—\$1,190<sup>00</sup>

**Model S-7210**—3 HP single phase motor • Spindle speeds 7000/10,000 RPM • 27½" x 39" table area • 34" table height • reversing switch • 1¼", ¾" or ½" spindle also available



## 12" Tilting Arbor Table Saw—\$1,090<sup>00</sup>

**Model T-8512**—40" x 30" ground table • Single phase 3 HP motor • Solid steel fence guide rail • Magnetic switch starter



## 12" Professional Table Saw—\$440<sup>00</sup>

**Model 8612**—Heavy duty for industry • 4¼" cutting depth with 12" carbide blade • Powerful 3 HP motor • Cast iron rip fence



## Mini Pin Router—\$990<sup>00</sup>

**Model R-7601**—1 HP 115/230 single phase motor • Cast iron frame • 16" x 20" ground table • Table tilts to 45° • Spindle stroke 1½", 20,000 RPM



## 12" Table Saw—\$190<sup>00</sup>

**Model 8412**—2½ HP, 14A powerful motor • All ball-bearing construction • Cutting capacity 4½" at 90°, 3" at 45° • Large 32" x 20" work table • Stand optional



## ½" Router Shaper—\$139<sup>00</sup>

**Model R-7205**—2 HP motor, 25,000 RPM • 15" x 20" table, grooved for chip relief • Fence adjusts independently or as a unit • Lockable safety switch

### Carbide Tipped Router Bits

Type	Size	Price
Straight—2 Flute	¼" to ¾"	From \$ 6.90
Cove—2 Flute	¼" to ½"	From \$13.00
14° Dovetail	½"	\$ 6.90
Roman Ogee	5/32" & ¼"	From \$16.90
45° Chamfering	½"	\$14.90
Corner Rounding	¼" to ½"	From \$12.90
Rabbeting	¾"	\$12.90
Core Box	¾" & ½"	From \$12.90
Vee Grooving	7/16"	\$14.90
Hinge Mortising	½"	\$12.90
2-Flute Flush Trimmer	½"	\$ 6.90

### Carbide Tipped Saw Blades

Part No.	Size	Price
141040	10" x 1" x 40T	\$28.80
141060	10" x 1" x 60T	\$33.90
141080	10" x 1" x 80T	\$45.20
141240	12" x 1" x 40T	\$33.00
141260	12" x 1" x 60T	\$42.50
141280	12" x 1" x 80T	\$48.00
1412100	12" x 1" x 100T	\$54.30

(with 5/8" adaptor)

### Carbide (3mm) Tipped Shaper Cutters

Type	Size (Bore)	Price
Tongue & Groove	2.50" O.D. (Set)	\$64.20
3-Wing Horizontal Panel Raisers	5° face cut, 15° face cut, Concave face cut, 12° face cut, Convex face cut	Each \$59.00
Quarter round	2.50" O.D. ¼" & ½"	\$32.10
Glue joint	90°, v groove, 30° bevel	Each \$32.10
Ogee	2.71" & 3" O.D.	Each \$32.10
Straight	¼" to 1"	From \$29.20
Flute (convex)	¼" to 1"	From \$29.20
Bead (concave)	¼" to 1"	From \$29.20
Door Lip	2.50" O.D. Dr. Rd. & taper rabbet	\$32.10
Sash	2.50" O.D. male or female sash	\$32.10

Call or Write for Free Catalog!  
Freight prepaid to local freight terminals

**KwiKut**  
Equipment Inc.

23140 Kashiwa Court  
Torrance, CA 90505  
(800) 621-0849 Ext. 467



# BEAUTÉ™

SATIN • CREME • WAX

The natural choice  
is good  
for your wood.

You're a person who takes pride in your work.  
So why use anything but the best?

Unlike other waxes, Beauté contains no silicones or paraffins. These substances can actually have an adverse effect on the finish of your fine wood.

Beauté is a natural blend, and it's good for your wood. Beauté protects and enhances, leaving no residue. And the soft, buttery texture makes it easy to apply.

Try the natural choice. Contact Roger A. Reed, Inc., P.O. Box 508, Reading, MA 01868. Telephone (617) 944-4640.



Professional Artwork  
Five Color Silk-screening  
Detail. This Woodworking  
Logo available on Hanes  
100% Cotton T-Shirts or  
Caps.

**T-SHIRT** - 10.95 - S, M, L,  
XL. White, Lt. Blue & Beige.  
**CAPS** - 7.95 - White, Blue,  
Green & Maroon.

CHECK  VISA  MASTERCARD

ACCT # \_\_\_\_\_

SIGN. \_\_\_\_\_ EXP. DATE \_\_\_\_\_

NAME \_\_\_\_\_

ADDRESS \_\_\_\_\_ CITY \_\_\_\_\_

STATE \_\_\_\_\_ ZIP \_\_\_\_\_







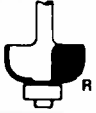

ITEM	SIZE	COLOR	QTY.	PRICE EACH	SUB TOTAL
T-SHIRT				10.95	
CAP				7.95	
SHIPPING & HANDLING					
T-SHIRT			1.50		
CAP			1.75		
<b>TOTAL</b>					

M.C./VISA CALL 1-800-826-1066

WOODWORKING DESIGNS • P.O. BOX 825 • RUSTON, LA 71270

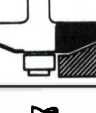
**\*SPECIAL SUMMER \$2.00 OFF SALE - SEE BELOW  
CARBIDE TIPPED ROUTER BITS  
PROFESSIONAL PRODUCTION QUALITY  
SPECIAL OFFER - SAVE 50%-75% BELOW COST**

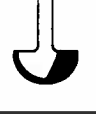
**1000's SOLD TO READERS OF FINE WOODWORKING**

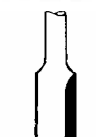
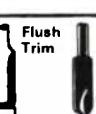
BEST CUT BEST PRICE	ITEM NO.	DESCRIPTION	RADIUS	LARGE DIAM.	CUTTING LENGTH	PRICE
	COVE					
	#01	1/4" R	1/4"	1"	1/2"	\$13.00
	#02	3/8" R	3/8"	1 1/4"	9/16"	14.00
	#03	1/2" R	1/2"	1 1/2"	5/8"	15.00
	ROUND OVER					
	#04	1/4" R	1/4"	1"	1/2"	15.00
	#05	3/8" R	3/8"	1 1/4"	5/8"	16.00
	#06	1/2" R	1/2"	1 1/2"	3/4"	19.00
	ROMAN OGEE					
	#07	5/32" R	5/32"	1 1/4"	15/32"	18.00
	#08	1/4" R	1/4"	1 1/2"	3/4"	20.00
	RABBETING					
	#11	3/8" R	Deep 3/8"	1 1/4"	1/2"	14.00
	#09	1/8" (KERF) SLOT CUTTER		1 1/4"	1/8"	14.00
	#10	1/4" (KERF) SLOT CUTTER		1 1/4"	1/4"	14.00
	#12	45° CHAMFER	45° Angle	1 1/2"	5/8"	15.00
	#15	RAISED PANEL	20° Angle	1-5/8"	1/2"	25.00
	DOVETAIL BITS					
	#16	3/8" DOVETAIL	9°	3/8"	3/8"	7.50
	#17	1/2" DOVETAIL	14°	1/2"	1/2"	8.50
	#18	3/4" DOVETAIL	14°	3/4"	7/8"	10.50
	CORE BOX (ROUND NOSE)					
	#19	3/8" CORE BOX	3/16"	3/8"	3/8"	11.00
	#20	1/2" CORE BOX	1/4"	1/2"	11/32"	14.00
	#21	3/4" CORE BOX	3/8"	3/4"	5/8"	18.00
	GROOVE FORMING OGEE					
	#22	1/2" GROOVING OGEE		1/2"	3/8"	16.50
	#23	3/4" GROOVING OGEE		3/4"	7/16"	21.00
	#24	1/4" Straight Bit		1/4"	1"	7.00
	#25	5/16" Straight Bit		5/16"	1"	7.00
	#26	3/8" Straight Bit		3/8"	1"	7.00
	#27	1/2" Straight Bit		1/2"	1"	7.00
	#28	3/4" Straight Bit		3/4"	1"	10.50
	#13	1/2" FLUSH TRIM		1/2"	1"	8.50
	#14	3/8" KEY HOLE (This Bit only HSS)	CUTS 3/8" KEY HOLE FOR FLUSH MOUNTING PICTURE FRAMES, ETC.			8.50

**WHEN ORDERING ANY 3 OR MORE, DEDUCT \$2.00 EACH\*  
ALL PRICES POSTAGE PAID \*OFFER EXPIRES 8/25/86**

- Professional Production Quality
- 1/2" Ball Bearing Pilot
- 1/4" Diameter Shanks x 1 1/4" Long
- One Piece Construction
- Two Flute Thick High Quality Tungsten Carbide Tips

To order by Master Charge or Visa Toll Free  
7 Day - 24 Hour Order Service Call  
1-800-523-2445 Ext. 56 (In PA 1-800-346-7511 Ext. 56)  
or send check to: **MLCS, Box 53F, Rydal, PA 19046**



## DELMHORST MODEL G-30

*The Wood Moisture  
Detector Preferred  
by Craftsmen.*

Simple, one-step operation • auto shut-off  
• built in battery & calibration check • 6-  
30% wood moisture content • use with  
any Delmhorst electrode for specific  
applications • made in USA.

Dial 1-800-222-0638 for details on  
our complete line.



**DELMHORST Instrument Company**

51 Indian Lane East • Dept. 908 • Towaco, NJ 07082  
In NJ 201-334-2557

Pink Ivory  
Dagame  
Brazilian Rosewood  
Pear  
Plum  
Burls  
Snakewood  
Bubinga  
Koa  
Satinwood  
Cocobolo  
Padauk  
Rosewood  
Bloodwood  
Ziricote  
Purpleheart  
C.Ebony  
Pau Rosa  
Camphor

## Quality Exotic Wood

» TURNERS «  
**Thick Planks for Bowls/Squares**

» CABINET MAKERS «  
**Individually Selected Lumber  
for  
Furniture/Boxes/Inlays**

Over 70 Species

All Inquiries Welcome... Call or Write  
**Berea Hardwoods Co.**  
125 Jacqueline Drive  
Berea Ohio 44017

It's a matter of  
pride for both of us

Pernambuco  
Mac. Ebony  
E.I. Rosewood  
Bocote  
Curly Maple  
Quilted Maple  
A.I. Ebony  
Zebrawood  
Lacewood  
Lignum Vitae  
Osage  
Tulipwood  
Blackwood  
Mahogany  
Jelutong  
Holly  
Wenge  
Goncalo Alves  
Many More...

It's a matter of  
pride for both of us

216-243-4452

## Makita

Call 1-800-2-MAKITA  
for Low Prices on  
Entire Makita Line  
• FREE FREIGHT •

**NEW!**  
LS1000 10" Mitre Box  
w/Visc. List \$348  
**SALE \$196**

2040 15-5/8" Auto-Feed  
Thickness Planer.  
List \$1780 **SALE \$1088**

6012HDW 2-Speed  
Cordless Drill  
w/Batteries & Case  
List \$178  
**SALE \$96**

**NEW!**  
2030N  
12 1/2" Planer & Jointer  
w/Electric Brake  
List \$2160  
**SALE \$1299**

5007NB  
7 1/4" Circular Saw  
List \$168 **SALE \$89**

2708 8 1/4" Table Saw  
List \$336  
**SALE \$194**

Makita Batteries 7.2 Volt  
List \$36 **SALE \$22**  
9.6 Volt, List \$40  
**SALE \$25**



**HOMELUMBER CO.**  
449 WHITEWATER ST., WHITEWATER, WI 53190  
IN WISCONSIN USE (414) 473-3538

Visa • Mastercard  
Check • Money Order

TOLL FREE  
1-800-262-5482

## VEGA LATHES & LATHE ACCESSORIES

Eight Lathe Models Available  
Solid Construction • Convenient Operation • Low Speeds • Great Capacity

Duplicators • Chisels • Chucks • Face Plates • Tool Rests

Send \$1.00 for complete catalog



**VEGA ENTERPRISES, INC.**

Route 3, Box 193 / Decatur, Illinois 62526

thoughtfully designed machines made in the USA



# Richard Raffan is now on videotape.

To help you master the moves that are so important to skillful turning, we've put together a new video workshop featuring the projects and exercises from Richard Raffan's popular book, *Turning Wood with Richard Raffan* (published in 1985).

Produced and directed to capture the book's more dynamic details, this companion videotape lets you experience the sights and sounds of woodturning from three different perspectives: up close, where the tool comes in contact with the wood; over Raffan's shoulder, as if you were doing the work yourself; and from a distance, where you'll see how the turner's stance, support and movements combine to produce fine control and predictable results.

Raffan begins the tape by demonstrating his own tool-sharpening techniques, then offers a series of gouge and skew exercises, slowing down periodically so you can analyze his motions. Building on these skills, he takes you step-by-step through six complete projects from his book: a tool handle, light-pull knob, scoop, box, bowl and breadboard. And because we've taped each project in its entirety, you'll gain a better understanding of the rhythm of woodturning as Raffan alternates between fast, efficient stock removal and delicate, precise detailing.

This is a rare opportunity to work alongside an accomplished craftsman—in your own home, at your own pace. Specific sections of the tape are keyed on screen to relevant pages in the book, so you can both read and watch as Raffan teaches you his craft. Whether you use the tape by itself or with the book, you're sure to come away with new skills and increased confidence at the lathe.

## **Save \$7.95 when you order *The Raffan Set*.**

Order Raffan's book and videotape together and you pay just \$49.95—a savings of \$7.95. Simply list *The Raffan Set* on the insert, and indicate your choice of VHS or Beta. (If you've already purchased the book, we'll be sending you a coupon worth \$7.95 towards the purchase of the tape.)

*The Raffan Set* (book and companion video) \$49.95 postpaid  
Publication #99

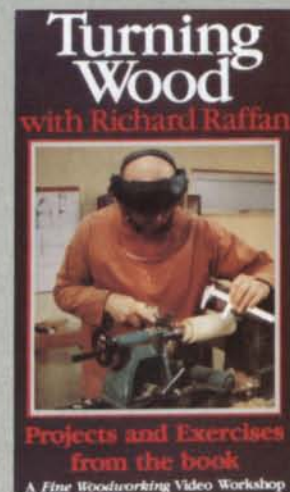

### **The videotape:**

117 minutes, \$39.95 postpaid

VHS: Publication #611

Beta: Publication #612

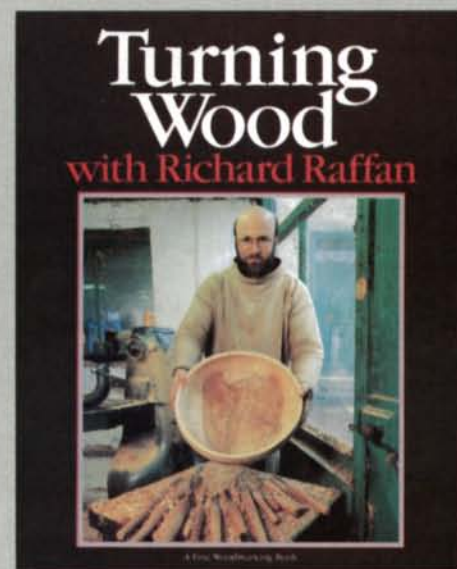

### **The book:**

176 pages, \$17.95 postpaid

Publication #39

To order: Use the insert or call toll-free, 1-800-243-7252, and use your credit card.

---

*Available May 15:*  
**Now you can make history.**

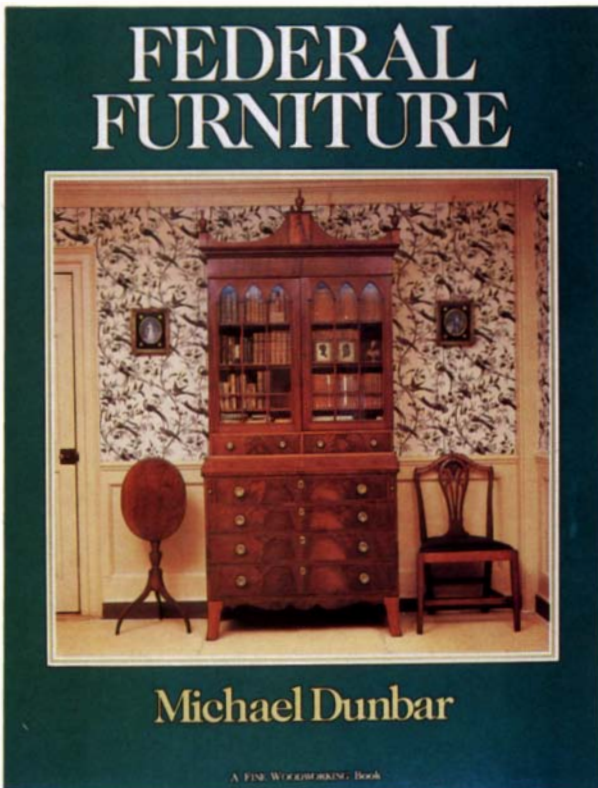

The Federal period was an exciting time in American history, and it gave birth to a revolutionary new style of furniture—light and graceful, yet remarkably sturdy.

Woodworker Michael Dunbar knows this furniture as few others do: both as a craftsman (his own work is part of the collection at Monticello) and as a collector (his faithfully-restored Federal period home is filled entirely with furniture of the age). Now, in his new book, Dunbar takes you into his workshop and his home to show you how and why Federal furniture was made as it was, and how you can make it today.

In particular, Dunbar examines 20 individual pieces from his own collection, including a card table, Pembroke table, candlestand, secretary, bellows, high-post bed, and Hepplewhite and Windsor chairs. To help you make each piece yourself, he provides measured drawings and practical construction information as well as detailed photographs, isometric drawings and step-by-step instructions for reproducing an aspect of the piece that is uniquely Federal—how to hand-carve spiral turnings on a mirror frame or produce the simulated cock-beading on a drawer front, for example. In some chapters, Dunbar devotes similar attention to techniques likely to be unfamiliar to modern-day woodworkers.

There are beautiful pieces here—enough to furnish a good-size home—along with a wealth of fascinating and practical insights into the work of early American craftsmen. So if you're interested in period woodworking—or want to find out why so many others are—take a copy of Michael Dunbar's *Federal Furniture* into the shop and make a bit of history for yourself.

*Softcover, 192 pages, \$18.95 postpaid Publication #41*



---

## *Also from Michael Dunbar*

The Windsor chair is one of the most popular chairs in the history of American furniture. It's comfortable, elegant, incredibly durable and, as you'll find in *Make a Windsor Chair with Michael Dunbar*, relatively easy to make. Using step-by-step photos and instructions, complete plan drawings, and scaled patterns for every part of the chair, Dunbar shows you how to make two styles of Windsor: the sack-back and the continuous-arm. You learn how to carve the seat, turn the legs and stretchers, bend the back, whittle the spindles and apply a traditional milk-paint finish. It's a great way to stretch your woodworking muscles; and when you're done, you'll have a wonderful place to sit and plan your next project.

*Softcover, 165 pages, \$13.95 postpaid Publication #27*

---

To order: Use the insert after page 18 or write the Taunton Press, 63 South Main Street, Box 355, Newtown, CT 06470.

The **'Versatile Saw'** — UNIQUE,  
Three machines in One

- Conventional tilting arbor table saw — 10"-12" with 5/8" arbor, for cross-cut, ripping and dado (5/8" x 8")
- PLUS traveling arbor for cut-off and miter, ideal for compound miter work (unique domestic manufacture)
- Large 36" x 54" table with extensions, up to 36" x 80" (optional)
- 24" Cross-cut, 18 1/2" cut-off travel and 3 5/8" depth of cut
- Up to 51" Rip to right of blade
- 2 HP, 1 Ph or 3 HP, 3 Ph
- 295 pounds, portable with handles



- Ground steel top, no distorting
- Vibration free, high torque, four V-belt drive system
- Arbor carriage travels on six sealed precision ball bearings

**'A Truly Unique American Built Machine'**

Manufactured by **The Versatile Saw Corporation** Since 1947  
\$2199. — delivered continental USA  
2HP with electrics & std. extensions



Western Avenue, P.O. Box 682  
Henniker, New Hampshire 03242  
603-428-3303

**Dealer Inquiries Welcome**

**ROUTER BIT CABINET DOOR SET**



Specially made for us by a small custom tooling company in the southeastern U.S., these handsome bits offer a convenient and effective method for complete frame and panel making — with only a router. Not miniatures, these bits make elegant full size panels. All bits have 1/2" shanks and ball bearing pilots. We like them so much we've put our name on them and will stack them up against any similar product on the market.

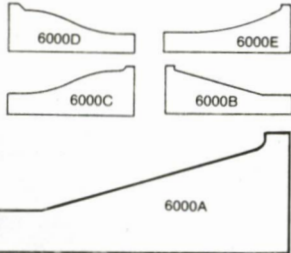

**ALL BITS \$99.00 EACH**  
PPD

**Why Buy Our Cutters?**

1. Only premium quality, micro-grain carbide used
2. Manufacturers sharpening service available
3. Made in USA
4. Full size profiles, not miniatures
5. Three wing panel raising bits
6. No alignment necessary, single pass operation
7. Router specials - call for details
8. **OUR GUARANTEE:** We are so confident that you'll like these bits that we offer a money-back guarantee. If you're not completely satisfied, return the cutters within 14 days of purchase date for a full refund.

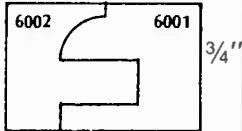

138  
THE **Xylophile's**  
COMPANY

138 E. Loudon Avenue • Lexington, KY 40505

VISA & MASTERCARD ACCEPTED  
**ORDER TOLL FREE**  
**1-800-354-9083**  
IN KENTUCKY CALL  
**(606) 254-9823**

**THE KUSTER GALLERY**

**Hurdy-Gurdy by Don Kawalek. Sanding by Kuster UltraSand.™**

*This hurdy-gurdy is my original design of a 17th-century instrument. Visually and acoustically it's a work of art, so it demanded exacting tolerances.*

*Each side had to have a consistent thickness of 3/32 of an inch. For precise thickness sanding, I use Kuster UltraSand. I get perfect results with less work.*

*Your masterpiece deserves only the best. For full details on the UltraSand Thickness Sander, call or write Kuster today.*

**KUSTER**  
Tools for Artistry in Wood

P.O. Box 31 • Skillman, NJ 08558 • 201-359-1680



**ASHMAN TECHNICAL LTD.**  
Machinery • Tools • Shop Equipment  
351 Nash Rd. N., Hamilton, Ont., Can. L8H 7P4  
(416) 560-2400

**Super Spring Specials**  
**Rockwell DELTA**



**3 H.P. 10" UNISAW \$1150.**  
**Unifence Model \$1350.**

*Fully compatible with U.S. electrics.  
3 H.P. Single Phase — 230 V  
60 cycle with Magnetic Starter*

- 34-897 Delta Unifence.....\$ 249.
- 13" Delta planer RC33 2HP with stand.....\$ 999.
- 20" Delta planer RC51 5HP.....\$3150.

**GENERAL**

- 12" Wood Lathe with Stand.....\$ 688.
- 10" Tilting Arbor Saw—3 H.P./Biesemeyer.....\$1425.
- 15" Woodcutting Bandsaw with Stand.....\$ 595.
- 8" Jointer with Stand.....\$1030.

Limited Quantities Available

— Electrics meet Canadian Regulations —

**ALL PRICES U.S. FUNDS. SHIPMENT FREIGHT COLLECT-NO OTHER CHARGES.**

## SPECIAL ROUTER BITS

At Furnima we take woodworkers special needs very seriously. Presented below is just a small sampling of our efforts to provide quality carbide tooling for discriminating woodworkers.

**FACE MOULDING CUTTERS**  
First some very beautiful profiles based on marketing plans designs. (Shows left)

Shank Dia.	Carbide Height	Beed Dia.	Price
FMC-001 1/4	5/8	3/16	31.20 US
FMC-012 1/4	5/8	5/16	35.19 US
FMC-01 1/2	5/8	5/16	35.99 US
FMC-02 1/2	1-3/8	5/16	43.99 US
FMC-03 1/2	1-3/8	5/16	43.99 US
FMC-04 1/2	1-3/8	5/16	43.99 US

**STANDARD CLASSIC (Above)**

Shank Dia.	Profile Height	Profile Width	Price
SCL-025 1/4	9/16	1/2	31.19 US
SCL-02 1/2	9/16	1/2	31.99 US

**OGEE WITH FILLET (Above), Profile (a)**  
Specify 3/8" bearing

Shank Dia.	Profile Height (a)	Profile Width	Price
OWF-02 1/4	1/2	1/2	31.19 US
OWF-02 1/2	1/2	1/2	31.99 US

**FRENCH PROVINCIAL CLASSIC**  
(Above) A beautiful table edge profile.

Shank Dia.	Profile Height	Profile Width	Price
PC-01 1/4	9/16	1/2	31.99 US
PC-01 1/2	9/16	1/2	32.79 US

**TWO NEW REEDING AND FLUTING CUTTERS (Above)**

Shank Dia.	Radius	Price
FB-02 1/4	3/16	28.40 US
FB-02 1/4	1/4	29.20 US
FB-04 1/4	3/8	33.20 US
FC-02 1/4	1/8	19.80 US
FC-03 1/4	3/16	21.60 US

**DISHCUTTER (Above)**  
For cutting pockets in serving trays, raised lettered signs.

Shank Dia.	OA Dia.	Carbide Height	Price
DC-01 1/4	1	1/2	23.40 US
DC-02 1/2	1-1/4	1/2	31.51 US

**THE FURNIMA DRAWER MAKING SYSTEM (shown left)**  
Use a combination of two cutters DC-02 and DJ-01 to make precision drawers. AVAILABLE IN 1/2" SHANK ONLY. Comes complete with comprehensive instructions. Price 73.32 US

**FINGER JOINT CUTTER FOR 1/2" ROUTER OR 1/2" SPINDLE SHAPER**  
(Shows Right) With three 2 wing stacked cutters for maximum material thickness of 1/4". Price 95.99 US

**MAKE T & G "V" JOINT WITH YOUR 1/2" ROUTER OR 1/2" SPINDLE SHAPER (LEFT)**

Shank Dia.	MATERIAL THICKNESS	Price
TOV-01 1/2	5/16 7/16	60.72 US
TOV-02 1/2	1/2 3/4	60.72 US

**US PHONE 1-613-756-3657**  
**CN PHONE 1-800-267-8833**

FOR FREE ROUTER BIT, SHAPER CUTTER AND SAW BLADE CATALOG SEND TO:  
FURNIMA INDUSTRIAL CARBIDE INC.,  
BOX 308, BIRNACKI RD. BARRY'S BAY, ON CANADA K0J 1B0

# KILN DRY YOUR OWN LUMBER

**nyle corporation**  
the nation's largest manufacturer of dehumidification dry kilns is now offering small 500 to 10,000 board feet drying systems.

- ★ Made completely in the USA
- ★ The leader of the industry
- ★ Offering excellent warranties
- ★ Expert consultation and service

## nyle DRY KILN SYSTEMS

Box 1107, Bangor, Maine 04401  
Phone (207) 869-9299  
Fax (207) 869-4335

## New GLOSS!

DEFT GLOSS CLEAR WOOD FINISH  
DRIES IN 30 MINUTES  
SEALS & FINISHES INTERIOR

Deft, Inc., Irvine, CA 92714 • Alliance, OH 44601

**"Really the BEST catalog I've ever used."**  
- E.F.M., Baltimore

The complete Craftwoods catalog includes fine hardwoods, woodworking tools and supplies, plus a featured section on decoy carving. It's yours for \$3—refundable on your first order.

**CRAFTWOODS**  
10921-F York Road  
Cockeysville, MD 21030  
301-667-9663

## Queen Anne Chair

by  
*Adams Wood Products, Inc.*

Ready to assemble  
Prompt delivery  
Any quantity  
Oak, Cherry, Walnut  
Mahogany, etc.

**FREE BROCHURE**  
974 Forest Dr. Dept. Q  
Morristown, TN 37814  
615/587-2942

## CONCEALED HINGES FOR WOOD AND GLASS DOORS

- Largest Selection
- European (35mm)
- No-Bore For Glass
- Face Frame

Allen Specialty Hardware's emphasis is on MODERN hardware for craftsmen. European concealed hinges are our specialty, not a sideline. We offer the best selection, best quality, and most assistance in using them. Glass door hinges are available in either 2-pivot or no bore in nine styles. Make your kitchen cabinets more functional with wire shelves, baskets and slides. Build a computer cabinet using our TV extension slides. Our hardware for stereo cabinets includes everything from casters to lid hinges. No minimum order requirement and our prices are low.

**STEREO AND KITCHEN CABINET HARDWARE**  
BRASS HARDWARE • SPECIALTY ITEMS  
SLIDES • CATCHES • WOOD PULLS • ELEVATORS

MAIL ORDER ONLY - CATALOG \$1.00  
**ALLEN SPECIALTY HARDWARE**  
DEPT. 5

P.O. BOX 10833 PITTSBURGH, PA 15236

# FREE COLOR CATALOG

## CLOCKBUILDING SUPPLIES

Send for your FREE copy of our new 48 page catalogue. Fully illustrated with the finest clock kits, movements, dials, finishing supplies, cabinet hardware, and tools. Satisfaction Guaranteed. Write today for your FREE catalogue.

**Mason & Sullivan**  
Dept. 2146  
586 Higgins Crowell Road  
W. Yarmouth, MA 02673



## PLANE JANE HAS A DATE.

**From March 1st to May 31st,  
get a FREE jig saw with Ryobi's AP-10 Planer!**

What an unbeatable pair — the new Plane Jane with our best jig saw, the electronic variable speed JSE-60!

Ryobi's Plane Jane has everything you want in a planer. Its lightweight (58 lbs.) and compact size (less than 2 ft. x 2 ft. x 2 ft.) make it practical for any workshop.

Yet it will plane material up to 10" wide and 5" thick. And Plane Jane's portability is a perfect match for contractors, who can take it to job sites as easily as they can a drill.

Find out why it's the hottest power tool to hit the market in years! And Ryobi has made the deal even sweeter by pairing Plane Jane with our super strong JSE-60 jig saw.

To take advantage of the offer, however, you must purchase Plane Jane between March 1st and May 31st. So look for it now!

To find the dealer nearest you, call toll-free 1-800-621-1776.

You'll see at first glance, the beauty of Plane Jane is how it works!

---

---

**Made for more than weekends.**



Bensenville, IL 60106



# FREE SANDING BELTS

## DIRECT FROM THE MANUFACTURER

GET SIX FREE BELTS FOR EACH DOZEN ORDERED. All belts are aluminum oxide first quality. Our electronic presses make smooth bump-free splices.

Check your size and how many dozen. We will ship assorted grits unless otherwise specified.

□ 1" x 30"	— \$12.70/doz.
□ 1" x 42"	— 12.75/doz.
□ 1" x 44"	— 12.80/doz.
□ 3" x 18"	— 13.75/doz.
□ 3" x 21"	— 14.25/doz.
□ 3" x 23 3/4"	— 14.70/doz.
□ 3" x 24"	— 14.75/doz.
□ 3" x 27"	— 15.25/doz.
□ 4" x 21 3/4"	— 16.75/doz.
□ 4" x 24"	— 17.25/doz.
□ 4" x 36"	— 20.95/doz.
□ 6" x 48"	— 26.95/1/2 doz. (3 FREE)

Other size belts on request.

### 9" x 11" Paper Sheets

A/O Cabinet Paper		No Load Finishing Paper	
	50/pk. 100/pk.	50/pk. 100/pk.	
□ 40-D	— \$17/pk. □ \$31/pk.	□ 180-A	— \$11/pk. □ \$19/pk.
□ 50-D	— 16/pk. □ 28/pk.	□ 220-A	— 11/pk. □ 19/pk.
□ 60-D	— 15/pk. □ 26/pk.	□ 280-A	— 11/pk. □ 19/pk.
□ 80-D	— 14/pk. □ 24/pk.	□ 320-A	— 11/pk. □ 19/pk.
□ 100-C	— 13/pk. □ 22/pk.	□ 400-A	— 11/pk. □ 19/pk.
□ 120-C	— 13/pk. □ 22/pk.		
□ 150-C	— 13/pk. □ 22/pk.		

### Wet or Dry S/C Paper

	50/pk. 100/pk.	
□ 220-A	— \$15/pk. □ \$25/pk.	
□ 320-A	— 15/pk. □ 25/pk.	
□ 400-A	— 15/pk. □ 25/pk.	
□ 600-A	— 15/pk. □ 25/pk.	

**NEW ITEM!**  
□ BELT CLEANING STICK - \$6.95

Prompt delivery from stock.  
**MONEY-BACK GUARANTEE**

Shipping Charges - Under \$35 add \$2.50; \$35 or more add \$4.00—PA residents add 6% sales tax.

Check or Money Order.  
 MasterCard  VISA Exp. Date \_\_\_\_\_  
 Acct. # \_\_\_\_\_  
 Name \_\_\_\_\_  
 Address \_\_\_\_\_  
 City, State & Zip \_\_\_\_\_

**CALL TOLL FREE**  
**1-800-428-2222**  
**PA Only - 1-800-222-2292**

**INDUSTRIAL ABRASIVES CO.**  
644 North Eighth Street  
Reading, PA 19603



## #AP-10 10" PLANER

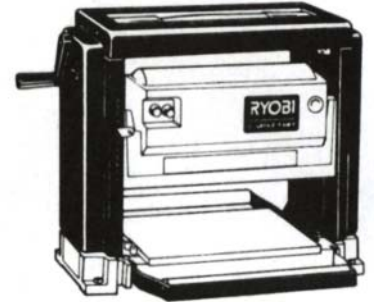

8,000 RPM — 26 ft. per minute  
LIST 13 Amp — 58 lbs.  
**\$659.00 Sale \$359.00**  
Delivered



or Super Sale of  
AP-10 PLANER plus  
RYOBI ORBIT JIG SAW  
for **\$409.00** Delivered

VISA/MASTER CARD - CHECKS - MONEY ORDER

**KINGSTOWN TOOL CORP.**  
P.O. Box 321 - Route 4  
North Kingstown, RI 02852  
401-295-2635 401-295-2636

## TOOL SALE

Most items shipped free freight within 24 hours

**PORTER-CABLE**  
PROFESSIONAL POWER TOOLS



	REG.	SALE
330 Speed Block Sander while qty last	87.50	54.00
621 3/4" varispeed reversible drill 4 amp	130.00	84.95
315-1 7 1/4" circular saw 13 amp	166.50	114.95
9627 2 speed tiger saw w/case	193.50	136.95
100 7/8 HP Router	141.00	99.50
7511 3/4" HD varispeed rev drill 5.2 amp	164.00	114.50
9629 Varispeed tiger saw w/case	204.00	149.95
7514 1/2" HD varispeed rev drill 5.2 amp	169.00	126.95
690 1 1/2 HP Router	194.00	149.95
312 Offset base laminate trimmer	205.00	149.95
7348 Jigsaw, varispeed	163.00	124.95

**DELTA**

34-410 10" Contractors saw w/stand & 1 1/2 HP motor less 100.00 rebate	1073.00	818.00
22-651 RC33 13" Planer, 2 HP motor	1729.00	1399.00
33-150 Sawbuck 8" trim saw	707.00	499.00
34-0105 Miterbox w/carbon blade 80T	300.00	179.00
28-560 16" 3 wheel band saw	467.00	359.00
28-243 14" Band saw, motor extra	624.00	459.00
17-900 16 1/2" Drill press 3/4 HP 3/4"	317.00	249.00
34-761 10" Unisaw w/1 1/2 HP motor	1632.00	1450.00
40-604 18" Electronic scroll saw	1117.00	899.00
62-142 1/2 HP motor (for 14" band saw)	125.00	89.00

Visa/MasterCard, check or money order  
Dealer inquiries welcome

**Wernitz Do-it-center**



1801 South Bend Ave.  
South Bend, IN 46637  
219-277-7732

SINCE  
1919

Send for your tool sale catalog

## The HEGNER Hobbymax!

Just imagine, your very own HEGNER Saw, now for less than \$400! Acknowledged as the industry leader, HEGNER's proven reliability and quality make the Hobbymax a miniaturist's and model-maker's dream! Even if you're just starting out, you don't have to settle for less anymore!

AMI also offers you the heavy-duty HEGNER Multimax and Polymax Precision Saws.

Call or write for free information today.

You'll be glad you did!

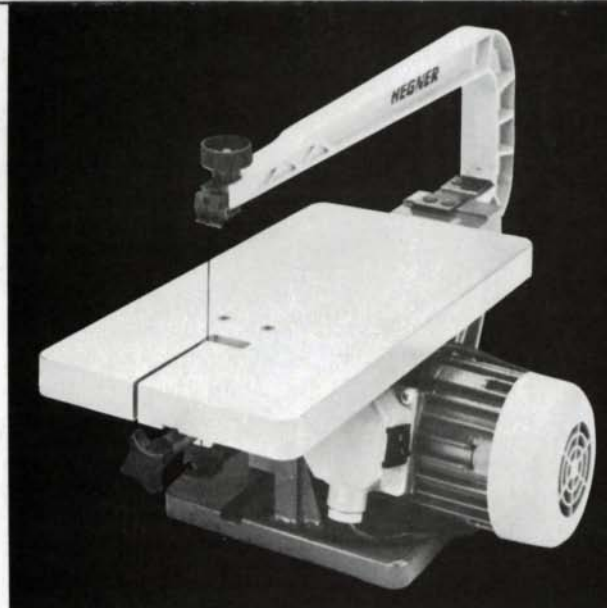

Please send me free information on the HEGNER Hobbymax.

Name \_\_\_\_\_  
 Address \_\_\_\_\_  
 City, State, Zip \_\_\_\_\_  
 Phone \_\_\_\_\_



**Advanced Machinery Imports**  
AMI, Ltd., P.O. Box 312, Dept 74  
New Castle, DE 19720  
302-322-2226



## DOMESTIC & FOREIGN HARDWOODS

Quality stock for  
Cabinet Work

Most all sizes from  
1" up to 4" in thickness

### HARDWOODS

ASH—BASSWOOD  
BIRCH—BUTTERNUT  
CHERRY—CHESTNUT  
EBONY—MAPLE—OAK  
POPLAR—ROSEWOOD  
TEAK—WALNUT  
Also hardwood plywoods

### SOFTWOODS

SUGAR PINE—CYPRESS  
CEDAR—SPRUCE  
DOUGLAS FIR etc.

**MAURICE L. CONDON CO., INC.**

248 Ferris Avenue  
White Plains, N.Y. 10603  
914-946-4111

Monday through Friday  
8 AM to 4:30 PM

# Consider The Best Carbide Cutter Available. Consider Freeborn.



Uncompromising quality . . . it's a big part of every shaper cutter we make. Maybe that's why we're America's fastest growing shaper cutter manufacturer.

When you need a durable, precisely engineered cutting tool, call the company with the OSHA safety orange cutters . . . Freeborn Tool Company.

Put our pride and quality to work for you.

**A Freeborn Carbide Tipped Shaper Cutter offers:**

- Geometrically precise design
- "Pro" (1 1/4" bore) and "Mini-Pro" (3/4" bore) lines in stock
- Low competitive pricing
- Immediate delivery
- Fast turnaround on "custom" orders
- Made in U.S.A.

For the dealer nearest you,  
call toll free 1-800-523-8988

Ask for our catalog and poster.

Dealer and OEM inquiries welcome.

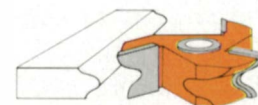

**Freeborn Tool Company, Inc.**

3355 E. Trent • Spokane, WA 99202 • (509) 535-3075 In Washington

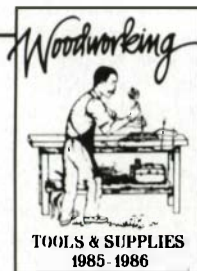

## QUALITY WOODWORKING TOOLS & SUPPLIES ARE AVAILABLE FROM THE FOLLOWING STORES:

**AAA Wholesale Tool & Supply**  
17309 Roscoe Blvd.  
Northridge, CA 91325  
(818) 996-1800

**Atlas American Tool Co.**  
1365 N. Catalina St.  
Burbank, CA 91505  
(818) 954-9497

**The Cutting Edge, Inc.**  
3871 Grand View Blvd.  
Los Angeles, CA 90066  
(213) 390-9723

**Cutting Edge of San Diego**  
7550 Miramar Rd. # 440  
San Diego, CA 92126  
(619) 695-3990

**Restoration Hardware**  
417 Second Street  
Eureka, CA 95501  
(707) 443-3152

**Restoration Hardware**  
Albion Street  
Mendocino, CA 95460  
(707) 937-0160

**Rosewood Tool Supply**  
1836 Fourth St.  
Berkeley, CA 94710  
(415) 540-6247

**Sawdust & Shavings  
Hardwoods**  
3518 Chicago Avenue  
Riverside, CA 92507  
(714) 781-0564

**Whole Earth Access**  
2990 7th St.  
Berkeley, CA 94710  
(415) 848-3600

**Brians' Tool Sales**  
19 Kreyssig Rd.  
Brookbrook, CT 06016  
(203) 623-6282

**Jacksonville Woodworkers  
Supply, Inc.**  
2535 Powers Ave.  
Jacksonville, FL 32207  
(904) 737-7508

**Highland Hardware**  
1045 N. Highland Ave.  
Atlanta, GA 30306  
(404) 872-4466

**Jones Hardwood Lumber Co.**  
201 30th St. S.E.  
Cedar Rapids, IA 52406  
(319) 362-3483

**The Woodcraft Shop**  
2724 State Street  
Bettendorf, IA 52722  
(319) 359-9684

**The Hardwood Connection**  
420 Oak St.  
DeKalb, IL 60115  
(815) 758-6009

**Cook's Country Stores**  
57 Main St.  
Gorham, ME 04038  
(207) 839-4856

**"The Tool Crib"**  
3625 Christy Way  
Saginaw, MI 48603  
(517) 791-3098

**Worden Woodworks**  
14617 Frazho Rd.  
Warren, MI 48089  
(313) 773-4406

**Restoration Specialty Co.**  
1629 N. Second St.  
St. Charles, MO 63301  
(314) 947-0030

**Northland Woodworking  
Supply**  
706 Court St.  
Utica, NY 13502  
(315) 724-1299

**The Tool Chest**  
45 Emerson Plaza East  
Emerson, NJ 07630  
(201) 261-8665

**Wood Worker's Store  
at Brewers**  
161 E. Boston Post Rd.  
Mamaroneck, NY 10543  
(914) 698-3232

**Denier Bros., Inc.**  
710 E. Shepherd Lane  
Cincinnati, OH 45215  
(513) 554-0449

**Moff-Master Power Tools**  
5228 Market St.  
Youngstown, OH 44512  
(216) 783-2130

**Quality Saw and Tool**  
328 South Main St.  
Mansfield, OH 44903  
(419) 526-4221

**Woodcrafters' Supply**  
7703 Perry Highway  
Pittsburgh, PA 15237  
(412) 673-4330

**Cherokee Lumber Co.**  
1410 Sevierville Rd.  
Maryville, TN 37801  
(615) 982-8250

**M. Chandler & Co.**  
6005 Milwee #709  
Houston, TX 77092  
(713) 683-8455

**Wood World**  
1351 So. Floyd Rd., Ste. 101  
Richardson, TX 75081  
(214) 669-9130

**Woodworker's Hardware**  
676 North Witchduck Rd.  
Virginia Beach, VA 23462  
(804) 490-9803

**Wooden Boat Shop**  
1007 Northeast Boat St.  
Seattle, WA 98105  
(206) 634-3600

**Woodcrafters Supply  
(Racine)**  
3701 Durand Ave.  
Racine, WI 53405  
(414) 554-2323

For other areas, contact: **Robert Larson Company, Inc.**  
82 Dorman Avenue, San Francisco, CA 94124 — Phone (415) 821-1021  
Dealer inquiries welcome on your letterhead.



### LEIGH DOVETAIL JIGS

Infinitely variable dovetails with  
ease and accuracy.

For free brochure call or write—

—U.S.A.: 1-800-663-8932 Toll free

—Canada: (604) 992-2440 Collect

LEIGH INDUSTRIES LTD.

Box 4646-A

Quesnel, B.C.

Canada V2J 3J8

**LEIGH**

# Fine Woodworking Design Book Four

## The state of the woodworker's art

### Call for entries... deadline October 30, 1986

This is an open invitation to woodworkers to submit photographs of the very best work you've done in wood during the past four years. Beginning this fall, the editors of Fine Woodworking will select several hundred photos for publication in Design Book Four, an up-to-date look at the state of the woodworker's art. In keeping with the growing use of color in woodwork of all kinds, Design Book Four will be printed in color.

As in our first three design books, the emphasis will be on thoughtful design and skillful craftsmanship. Our intent is to show the tremendous breadth and vitality of the woodworking craft, to serve as an inspiration for today and a record for tomorrow. Besides photographs of recent work, Design Book Four will also contain a comprehensive, state-by-state Directory of Woodworkers. Because of the enormous number of photos we expect to receive, only a small fraction of those who enter this competition

will have their work published. However, all entrants, whether accepted for publication or not, will be eligible for a directory listing. We are accepting entries from now until October 30, 1986.

**RULES** Each entry must consist of no more than five color transparencies of wooden objects designed and made by an individual woodworker or a woodworking partnership. Each entry must be accompanied by the completed entry blank shown below. The entry blank may be photocopied.

- The work submitted must be of original design completed since 1982. The primary material must be wood. There are no restrictions on species of wood, tools, techniques, function, style or scale. If it's wood and you made it, you can enter it.

- An entry may focus on a single object (overall view plus detailed close-ups) or up to a maximum of three different objects. The entry blank has space for one object. If you submit more than one, you must enclose an entry blank for each and identify which photo belongs to which entry blank.

- Photographs must be good-quality color slides (transparencies), not color negatives. The photo background should be featureless and of a color that doesn't interfere

with the wooden object itself. Please leave space around the object within the photo for cropping.

- We prefer 35mm slides, but all color transparency formats will be accepted, including 2¼ in., 4x5, 6x7 and 8x10. Whether your photos are mounted slides or larger transparencies, each must be submitted inside a protective clear plastic sleeve, not paper or cellophane sleeves or plastic or paper boxes (see p. 108 for more information on photos). Each transparency must be labeled legibly with your name and address—printed on a label attached to the protective sleeve for large format or directly on each 35mm slide frame. Unlabeled photos will not be judged.

- Snapshots, color prints, Polaroids and black-and-white prints cannot be published and will not be judged.

- Entrants whose photographs are published will receive one free copy of Design Book Four. Each entrant, whether published or not, may purchase up to ten copies at 25% off cover price.

- If you want your photos returned, include a self-addressed stamped envelope. Otherwise, photos will not be returned. If you wish to be acknowledged of receipt of your entry, include a self-addressed, stamped postcard listing the photos submitted.

### Entry Blank for Design Book Four

Mail to: Design Book Four, Box 355, Newtown, CT 06470

Name \_\_\_\_\_ File Number (office use) \_\_\_\_\_

Mailing address \_\_\_\_\_

City and State \_\_\_\_\_ Zip \_\_\_\_\_

Phone \_\_\_\_\_

Number of photos submitted \_\_\_\_\_ (Make sure each object has an entry blank)

Title and/or function of entry \_\_\_\_\_

\_\_\_\_\_

Woods used \_\_\_\_\_

Principal woodworking techniques used \_\_\_\_\_

\_\_\_\_\_

\_\_\_\_\_

If you wish to make additional comments, please do so on a separate sheet. We may excerpt what you write for publication.

Do you want to be listed in the Design Book Four Directory of Woodworkers?  
No  Yes  list me as:

Shop name \_\_\_\_\_

\_\_\_\_\_

Address \_\_\_\_\_

\_\_\_\_\_

City and State \_\_\_\_\_

Zip \_\_\_\_\_ Phone \_\_\_\_\_

Specialties of shop, maximum 10 words:

\_\_\_\_\_

\_\_\_\_\_

\_\_\_\_\_

# When was the last time somebody besides your mother sent you a \$100 check?



People just don't send you a hundred bucks for no reason. (Even your mother waits for your birthday.)

But if you buy one of our 10" Contractor

Saws\* between January 1 and June 30, 1986, Delta's going to send you a \$100 rebate check. You find the best deal you can—then we take \$100 off the top.

For no particular reason at all.

We're not doing it to push our 10" Contractor's Saw. It's the *original* contractor's saw, and it's always been one of our best-sellers. And

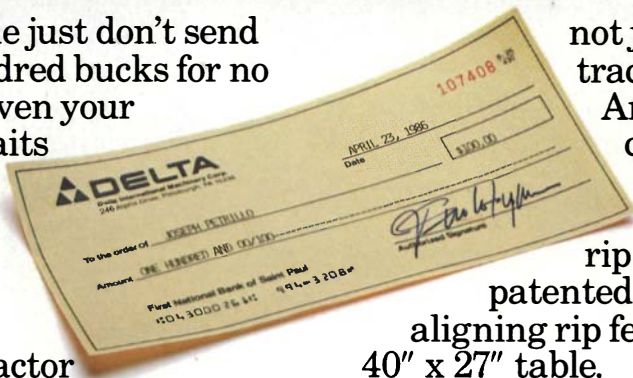

not just with contractors, either.

Any serious craftsperson can appreciate our 25" rip capacity, our patented JetLock self-aligning rip fence, our big 40" x 27" table.

And we're certainly not doing it to disguise a so-so product. Delta continues to set standards for precision and reliability—with the contractor's saw and *all* our products.

Mostly, we're doing it for those folks who've never owned a

Delta. To help nudge them into making a decision they'll never regret.

Because once you work with a Delta, we'll spoil you for life.

Just like Mom.

Call toll-free for the name of your participating Delta dealer:

Delta International Machinery Corp.,  
800/438-2486  
(in PA, 800/438-2487).



Offer good only on sales in the continental U.S., Alaska and Hawaii.

\*Models 34-410 w/motor or 34-440 w/motor

**DELTA**  
Building On Tradition

# NEW FROM SAWHELPER™



\$55.95

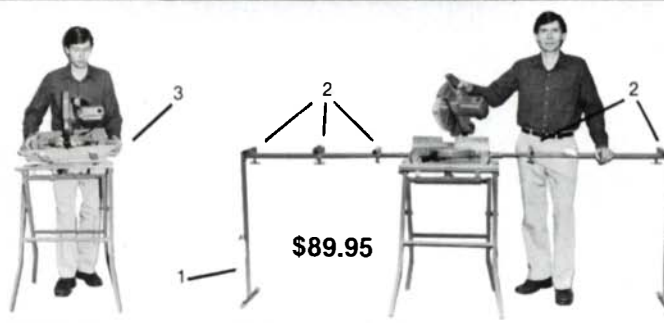

\$89.95

## YOU'LL NEVER STRUGGLE WITH UNWIELDY LUMBER AGAIN!

New LUMBERTUNG™ Heavy Duty easily supports me and this stack of 2x10's. Use it with your Rockwell Sawbuck or radial arm saw for man sized jobs. Just add a 2x10 or plywood top (about \$5) and you'll have a portable table for any situation. LUMBERTUNG™ includes the patented SAWHELPER™ SELF SQUARING COUPLER that squares the table in three directions instantly. You'll also get a heavy folding telescoping leg, leg keeper lock, and a convenient carrying handle. LUMBERTUNG™ can be coupled end to end to create tables of any length. For accuracy or production work, add JIGFENCE™ and FLIPSTIP™ (below) at our special package price. MONEYBACK GUARANTEE.

TELEFENCE™ is a superior telescoping miter fence system built to SAWHELPER™ specifications. That means you'll get thoughtful design, such as telescoping legs on both sides of the saw that pivot to accommodate any terrain (1), 5 lumber supports (2), and a quick change lumber stop. TELEFENCE™ can be used with any type of miter box stand, or with our new LOCK-TOP™ miter box stand with it's fir plywood quick release saw mounting plate (3). Telefence extends to 12 feet, all components fold completely flat.

LUMBERTUNG™ HEAVY DUTY  
LUMBERTUNG™ with JIGFENCE™ and FLIPSTOP™

Model LTHD \$55.95  
Model LJ7F \$139.95

TELEFENCE™ Telescoping Miter Fence Model TF \$89.95  
LOCK-TOP™ Miter Box Stand Model LTS \$69.95  
TELEFENCE™ LOCK-TOP™ stand Combo Model TLTS \$149.95

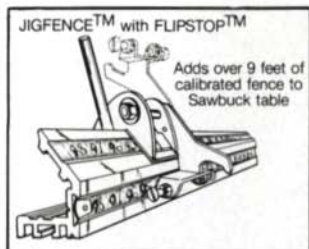
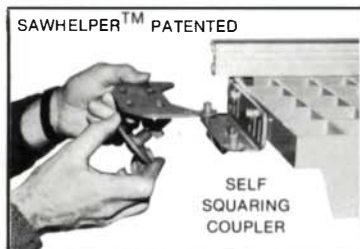

### ORDERING INFORMATION

21086

SAWHELPER™ products are available at fine tool stores or by mail from:

AMERICAN DESIGN AND ENGINEERING INC.  
648 Turin Ave. • So. St. Paul, MN 55075 • 612-455-4243  
TOLL FREE 1-800-441-1388

Freight prepaid to your door. Pay by check, COD, MC/Visa. Order should arrive within 5 days - 48 States. Minnesota and Wisconsin Residents add sales tax.

*For the Serious Woodworker . . .*  
No more changing blades for rip, miter and crosscut—or for different kinds of material!

## NEW LOW PRICES

### Why Buy 3 Blades When This ONE DOES IT ALL?

### RIP-COMBINATION-FINE CROSSCUT

*Made in America & maintained here in America for your benefit.*  
Keep like-new performance, use our superior micro-edge factory sharpening!

**WOODWORKER I** (For the Radial Saw) This is my *original* Woodworker blade—most desired by the American craftsman. Kerf 3/32", 60 teeth. Modified triple-chip with micro-finish grind. Carbide C4 hard and 40% stronger. Perfect, polished cuts in every direction. The one blade that does it all—for as long as you'll cut wood or plastics. Designed for use primarily on your radial saw, thin kerf gives better control and less bottom splinter. Available in 8", 9" and 10" diameters. Recommended to use with dampener. See below.

**WOODWORKER II** (For the Table Saw) My new ALL PURPOSE blade—*primarily* for your table-saw 1/2" kerf. 30 to 40 teeth (see below). Modified alternate-bevel with micro-finish grind. Exclusive Forrest 400 carbide. Designed for super-fast and planer action in ripping heavy, solid stock with a smooth-as-sanded surface. We rip 2" Red Oak with 1 HP at the shows leaving surface smoother than a planer. Slices ply-panels, particle-board and one-side laminates *quick and clean*. Crosscuts and miters with equal quality and ease and no bottom splintering. Generally, I recommend 40 teeth. However if your ripping includes a lot of heavy 1 1/2" to 2" hardwoods, specify 30 teeth. See dampener information. Available in 7" thru 10" diameters.

**AVOID cheap imports! WOODWORKER II eliminates scratchy saw cuts for the rest of your life!**  
*We're proving everything we say in our ads—in major shows across the country.*

**DAMPENER-STIFFENER One Side Aids A Smoother, Quieter Cut!!**

- Holds blade rigid and true for better cuts on your machine.
- Dampens out motor and belt vibrations from being transmitted up to the rim of the teeth causing scratchy cuts.
- Greatly reduces cutting noise.
- Helps kill saw scream-whistle from any vibrating blade surface.
- Is hardened and precision ground parallel and flat within .001" to keep your blade true.

- Can be removed instantly if need requires for deep cuts.
- One against the outside leaves blade centered in slot of steel table insert.
- 6" dampener on 10" blade gives 2" cutdepth. Use 5" dampener if always in 1 1/2-2" deep cuts. Remove or use 4" for 3" cuts. For 8" and 9" blades, figure dampener size accordingly.

**6" Dampener \$23 • 5" Dampener \$22 • 4" Dampener \$20 ADD \$2 SHIP.**

Jim Forrest, President and designer, microscoping cutting edge.

**SPECIAL SPRING SALE**  
March - June 1988

WOODWORKER I Radial Saw		WOODWORKER II Table Saw	
	WAS		NOW 50% OFF
10" 60T	\$182	10" 40T	\$156
9" 60T	156	30T	135
8" 60T	150	9" 40T	146
		30T	125
		8" 40T	136
		30T	115
		7 1/2" 30T	112
		7" 30T	112
		8" Dado 24T	299

**Now 209**

**WE RECOMMEND OUR FACTORY SHARPENING . . . 2-3 DAYS ON THESE AND ALL MAKES OF CARBIDE TIP SAWS. SHIP IN UPS OR FP. 10 X 40 \$14 NOW . . . ORDER the one blade that will outlast you! (10-20 sharpenings possible).**

*Dealer Inquiries Welcome.*

Your cutting satisfaction guaranteed or full cash or credit refund.  
40 years of fine American saw making & sharpening.  
**FORREST MANUFACTURING COMPANY, INC.**  
250 Delawanna Ave., Clifton, NJ 07014

# FORREST

We honor Amex, Visa & MasterCard, Money Orders, Personal Checks and COD's.  
To order **BY MAIL** clip ad, circle choices and enclose payment. Specify Dept. FW when ordering.  
**PHONE TOLL FREE!**  
1-800-526-7852 (In NJ: 201-473-5236)



**GRIZZLY'S  
SUPER  
SELLERS!**

**CALL OR WRITE FOR MORE DETAILS  
AND LOW, LOW FREIGHT RATES.**

So you still don't have our fully loaded, color catalog? Send \$3.00 and we'll whip it out to you and also keep you regularly informed on specials! High quality tools and machines at lowest prices. We import and sell direct, if you don't buy from us — we both lose!



IMPORTS, INC.

P.O. BOX 2069, BELLINGHAM, WA 98227  
PHONE (206) 647-0801 - SEVERAL LINES.



# Shaker Casework

*Simplifying the glories of Sheraton and Chippendale*

by David Lamb



Even though I'm not a Shaker, I've lived most of my life in the Canterbury, N.H., Shaker Village where my stepfather is curator. For several years I was the village's resident cabinetmaker and operated a shop that was open to the public during the summer. Even though the Shaker cabinetmakers were gone by the time I learned my craft, I think the furniture, cabinetry and philosophy they left behind have profoundly influenced me, and that's apparent in both my contemporary and traditional work.

I don't just copy Shaker furniture, although I like the simplicity, balance and delicate refinement of many of the original pieces. As a craftsman and designer, I tend to start with ideas presented in the old pieces, then add my own touches to simplify or elaborate on these themes. Whenever I work from a Shaker original, my goal is always to take the good, throw out the bad, and try to bring each piece to its highest possible level. I make a coffee table, for example, that is a take-off on the large work tables at Canterbury. I incorporated the contours of its turned legs, its dovetailed drawers, and the small dropleaf on the back side in a very compact, functional and visually pleasing design for a piece of furniture the industrious Shakers just didn't have in their homes.

Not all Shaker work is particularly good. You'll see many Shaker pieces with shoddy, nailed joints and lots of visible saw marks. Even some of these cruder pieces, most likely built by Shaker farmers or other tradesmen filling in for trained woodworkers, have pleasing designs. If I were going to adapt one of these cruder pieces, perhaps one of the simple wall cabinets installed in many Shaker workshops, I would replace the dadoed-and-nailed joints with dovetails and probably add raised or flat panels for the cabinet doors, but strive to preserve the proportions and simplicity of the original.

Most of the best Shaker work was done between 1800 and 1860, when Shaker communities throughout the country were prospering and the religious fervor of the sect was at a high level. Because Shaker furniture was built over such a long period by numerous workers in more than 20 different communities, it's difficult to define what makes Shaker work "Shaker." The finest pieces demonstrate an extraordinary level of craftsmanship and attention to detail, along with a passion for efficiency and function. The Shakers created an incredible range of tables and carcasses, both free-standing and built-in, often filled with custom-fitted drawers, as well as cupboards, shelving units and benches designed to meet the needs of groups of people trying to live together communally.

Sewing desks, the design source for the piece shown on the facing page, are a good example of the Shakers' skill at blending delicate framing elements, highly figured wood, and well executed joinery into an eminently functional piece. The desk features a good work area and supplemental slide-out writing/work surface. Placing drawers on the side, as well as the front, allowed two Shaker sisters to work together efficiently in a relatively small area. In addition to the functional aspects, some of these pieces featured precisely cut joints and such dazzling visual contrasts as bird's-eye maple panels framed with walnut.

There is nothing unusual about Shaker joinery, except that it was consistently well done in the finer pieces. The Shakers favored dovetails—both through and half-blind—and made good

*Shaker sewing desks are eminently functional, as well as a skillful blend of delicate framing elements, highly figured wood and well executed joinery. Having drawers on two sides of the piece allowed two Shaker sisters to work together efficiently, in a relatively small area. This chest is based on one probably built in the Enfield, Conn., community about the middle of the 19th century.*

use of mortise-and-tenon joints. On this piece, for example, the quirk bead worked on the rails and stiles is mitered at the joints to make everything fit nicely.

Frame-and-panel constructions, executed in cherry, maple and walnut, were favored for refined home furnishings, such as the sewing cabinet. This type of construction was very popular with cabinetmakers, but it was by no means new—its roots can be traced back to the time of the pharaohs. By using frame-and-panel techniques, cabinetmakers could build large pieces of furniture using short and narrow pieces of wood, without having to resort to extensive glue-up to make solid, and somewhat unstable, sides and backs. These short pieces could be joined together with mortises and tenons or dovetails, joints well-suited to the skills of craftsmen schooled in handtool techniques, to create very strong and stable cases. The cabinetmakers also favored highly figured wood, such as burls, crotches and branch figures, which were often available only as small pieces. These pieces were traditionally resawn so they could be matched together to create consistent grain patterns, and frames were an ideal way to display and accent these matched grains. The thinner, resawn pieces were also well suited for fitting into grooves plowed into the frames.

Although the Shakers benefited from the fact that the thin panels floating in frames tended not to split with the changing seasons, they apparently were most concerned with making efficient use of natural materials and with displaying wood grains, rather than with wood movement, one of the chief reasons we use the method today. Like their contemporaries, the Shakers didn't worry much about wood movement—they often rigidly nailed moldings perpendicular to the grain of the sides—but they worked before central heating introduced serious expansion and contraction problems. When beautiful, wide pieces of old pine were available, carcasses often had solid sides. The tops of tables and cases were single solid boards or edge-joined of just two or three wide pieces.

The major design sources for the Shakers undoubtedly were the same as those of their more worldly contemporaries: mainly Sheraton, Hepplewhite, and country Chippendale styles. The Shakers simplified these designs greatly, though. If you examine fashionable early 19th-century pieces (*Fine Points of Furniture*, Crown Publishers, Inc., New York, shows quite a few), you see many that are strikingly similar to Shaker pieces, once you imagine them stripped of all the elaborate turning, carving, veneer, inlay, applied molding, and brass work. Many small tables, especially those built at Canterbury, mirror the Sheraton fondness for thin tapered legs with balls near or at their feet. Gone, however, are the elaborately molded edges of the Sheraton top and apron. Canterbury workers also built solid-side bureaus and blanket chests that had bracket feet with cyma curves or ogee cutouts and moldings, which reflect Chippendale forms. Shaker woodworkers who learned the craft before joining the community would have been very familiar with these contemporary styles.

The drive to simplify contemporary designs, avoid excess ornamentation, and maintain rigid quality standards can be traced directly to the Shakers' religious beliefs. Work was a form of prayer, and timeless perfection was the only acceptable goal. The community itself and its millennial laws provided guidelines for wood use, embellishments, color, what was acceptable and what wasn't, and what the piece would be used for. Even though the communities were scattered from Ohio and Kentucky to Maine, the ministry traveled frequently, promoting consistency and high standards from community to community.

Very few Shaker pieces are signed, so it's sometimes difficult to determine who made what and where. Achievement for its

**Fig. 1: Shaker sewing cabinet**

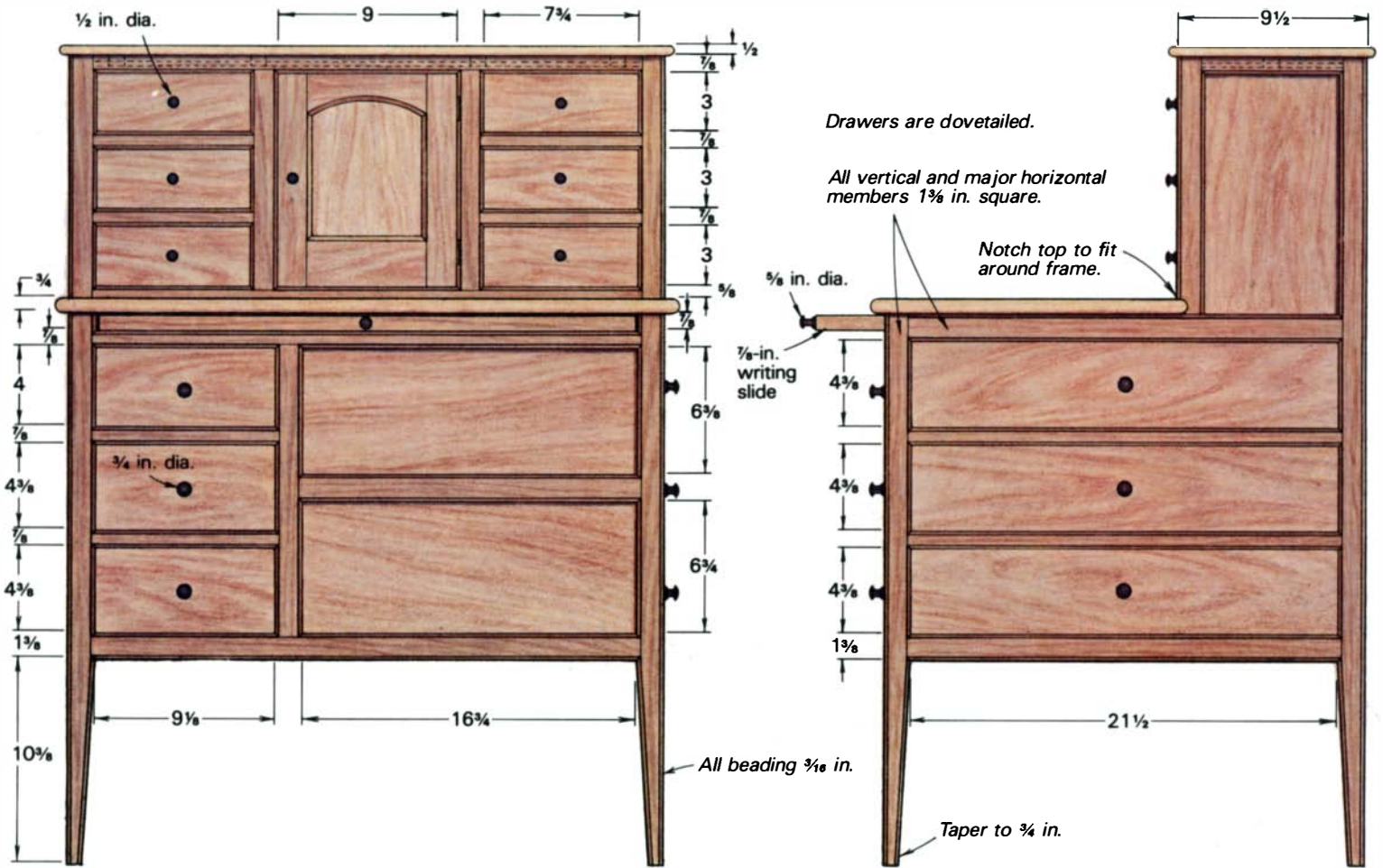

**Fig. 2: Writing slide and cupboard door**

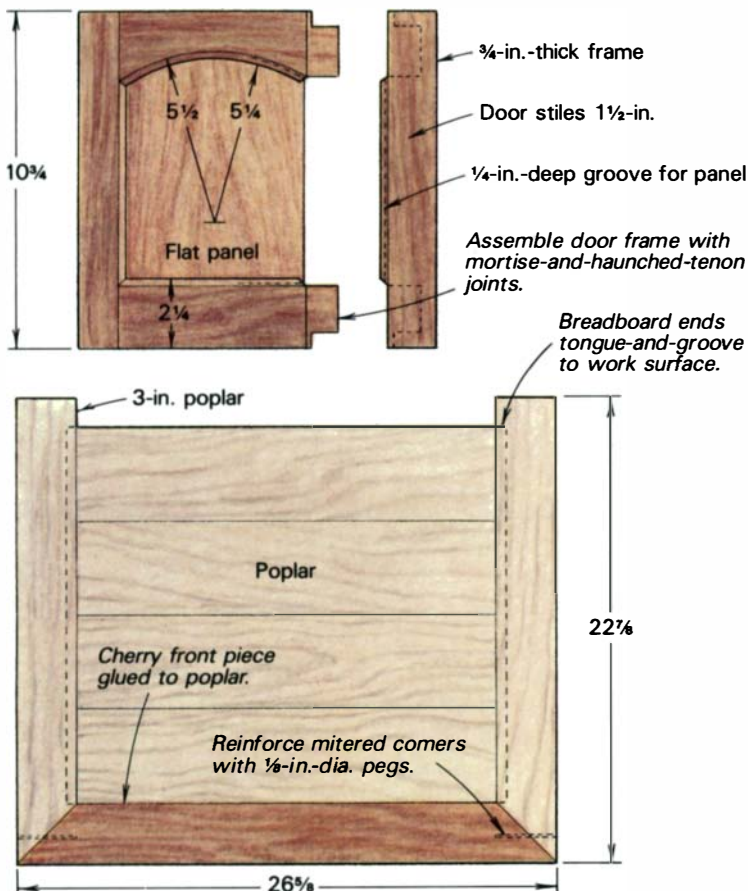

own sake was not encouraged. Rather than encourage recognition for an individual, the Shakers stressed perfection as a way of reaching a higher plane of existence. Even without the cabinet-maker's signature, many pieces show undeniable similarities in the way proportions, turnings and tapers were handled. Many of the tables made at Canterbury are so similar, for example, they were probably all made by the same man. Pieces from New England and Mt. Lebanon, N.Y., all have what I can only describe as a nice feel about the way their makers gently tapered their table legs and created a pleasing balance with the unusual overhang of the tops and subtly shaped edges. In all the communities, delicate handturned pulls were favored. Despite these similarities, I don't think any of the ministers and craftsmen ever sat down to formulate a Shaker "style." The designs were more the result of religious tenets on simplicity and harmony, and a passion to ensure that form was inseparable from function. Displaying wood grain was itself a new development among the Shakers. The early religious leaders had proclaimed wood grain to be distracting, capable of inflaming the passions, and had ordered everything painted. When the restrictions against more natural finishes were relaxed, many Shaker communities stripped the paint off much of the furniture, doors, and other woodworking in their homes.

Another significant design factor was that the Shakers didn't produce furniture for commercial sale, except for chairs and stools manufactured at the Mt. Lebanon community. They made communal furniture to fit in specified locations and to meet specific needs. This explains why some pieces are asymmetrical—they had to fit a particular spot in a particular building. Since the Shakers had a reverence for taking care of all things, whether it



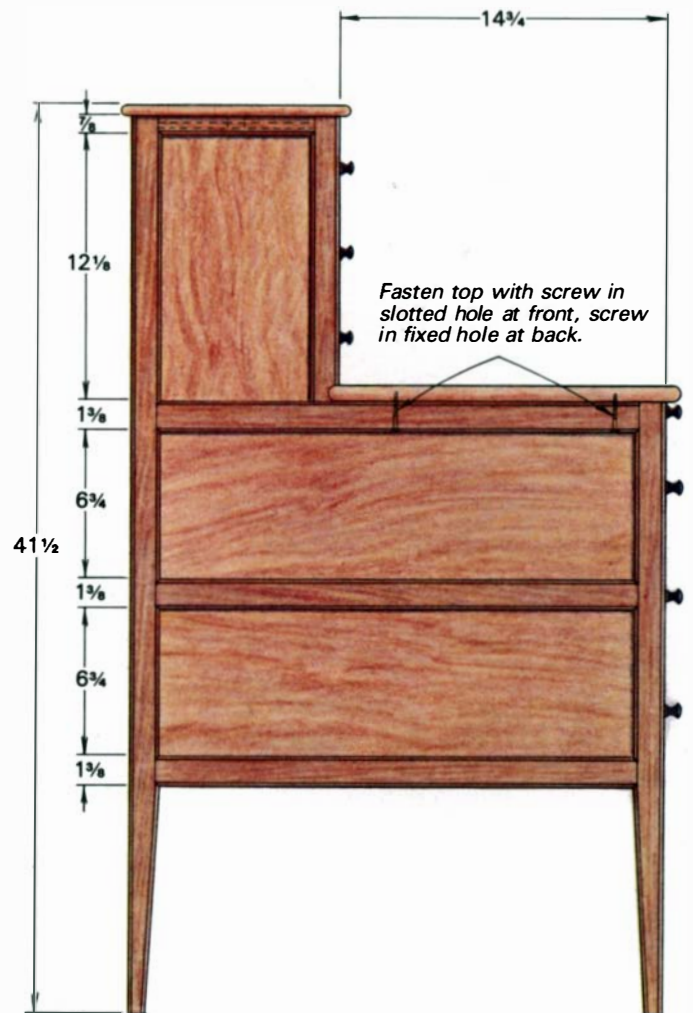
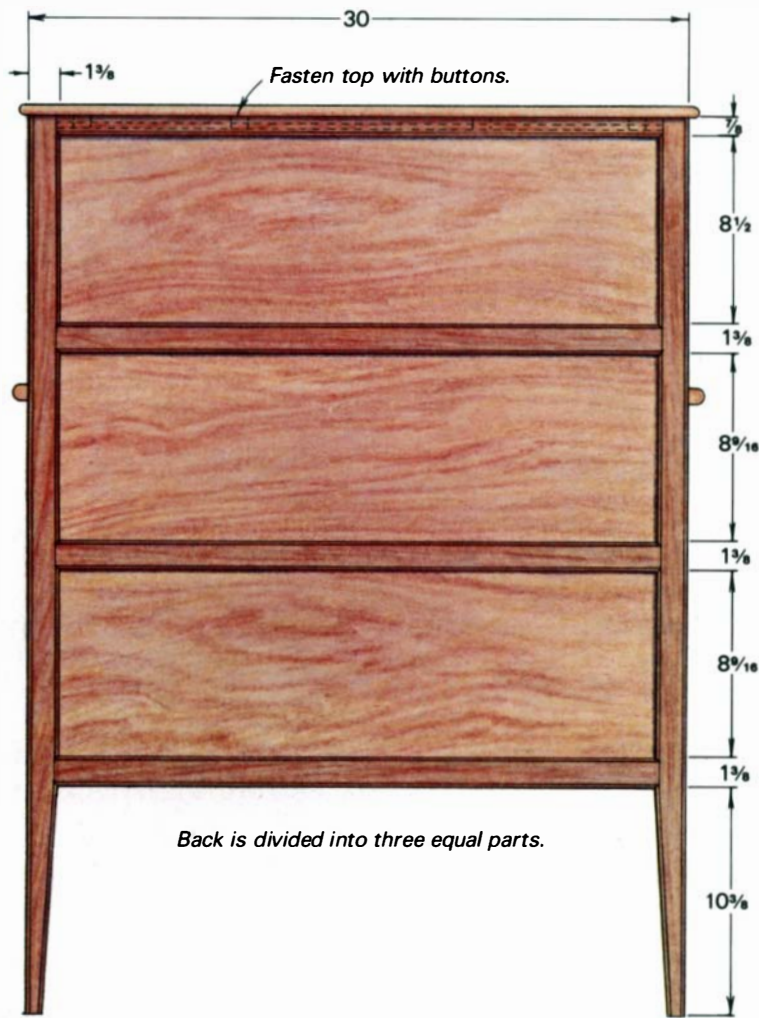

was children in the schools, animals in the fields or furniture; furniture could be more delicately designed than pieces destined for harsher treatment in the secular world.

I began work on my sewing chest by examining a walnut and poplar cabinet now displayed at the old meeting house in Canterbury. The chest is believed to have been built in the Enfield, Conn., community about the middle of the 19th century. I was interested mainly in size and proportions, rather than in deciphering the details of the original joinery and construction methods. I recorded the dimensions on a story stick, which I made from a piece of heavy cardboard. A story stick, which is as long as the longest frame piece (in this case the back post), contains all the information needed to construct the case—location of rails and stiles, top height and thickness, taper of legs, etc. The stick does not detail joinery. The cabinetmaker's knowledge of construction makes that information unnecessary, but during stock preparation you must remember to provide enough wood for cutting the joints. To record overall dimensions and proportions, I also made sketches of the front and side views of the piece, along with details. Later, I modified the original proportions a little, making the legs more graceful and slightly longer for today's taller people.

Like other 19th-century woodworkers, the Shakers relied heavily on handtool techniques. I like to cut joints by hand, hand-plane and scrape pieces whenever practical, but I'm not against machines. Neither were the Shakers, and I know they would approve of my shaper, tablesaw and planer, for they used them themselves. The Shakers excelled at taking advantage of whatever technical innovation appeared on the market. The Canterbury Village, for example, had electricity before anyone else in

the area because they built their own generating plant. Local farmers would wait and see what new products the Shakers bought before they invested any of their own money. The Shakers also made many of their own machines—they built the first machine to make tongue-and-groove boards, for example.

The paneled construction is such a good showcase for wood grains that I decided to build with cherry and poplar for the interior, secondary wood. I rough cut all the pieces needed for the chest at once, leaving things slightly oversize, then planed them to the proper width and thickness. I left each piece slightly long until I cut the joints. I don't make a materials or cutting list before I begin, but am particularly careful about labeling each piece and laying them out in units, for example all the top rails and stiles together, to make sure that I don't overlook any parts. This is a fairly complicated structure, so you should study the plans carefully before beginning.

When you lay out the mortises and tenons for the frame, you must set back the tenon shoulders, as shown in figure 3, to accommodate the mitered beading. I run  $\frac{3}{16}$ -in. beads on my shaper before cutting the joints. I could not find a commercial beading cutter with the profile I wanted, so I ground a custom knife from bar stock. I also mortise-and-tenon the front ends of the drawer runners into the drawer rails, and the back ends are screwed to posts, partitions and sub-posts, which are attached to the partition needed to support the side drawers. The Shakers usually nailed or glued theirs, but I like the added strength and neatness of the mortises. I tend to overbuild sometimes, compared to the delicacy of the original works, but I feel that the added strength is necessary because I don't know how

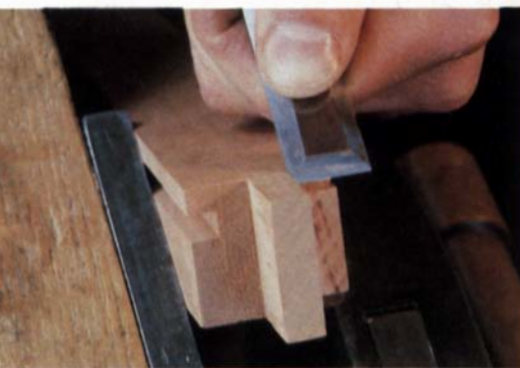

*After sawing through the bead with a backsaw, Lamb pares away most of the waste with a sharp chisel, above top. Lamb carefully pares down to the miter line he previously marked, above center. The tenon shoulders, above, are chiseled the same way: one heavy cut, then light paring cuts to fit the joint. At right, the case is assembled dry to make sure everything fits. The panels are added when the frame is glued up.*

roughly the piece will be treated once it leaves my shop.

After cutting all the tenons on the tablesaw and the mortises on my drill press set up for slot mortising, I square up the slots with a chisel, and trial fit the mortises and tenons together. Next I put a dado head on the saw to plough  $\frac{1}{4}$ -in. grooves for the panels. I carefully cut and pare the bead miters, as shown in the photo series above, on the rails and posts. I do this by eye, although you could cut a  $45^\circ$  angle block to guide your chisel. I first mark the miter locations on the post, then remove the bead in front of the mortise area with a handsaw and chisel. Saw the waste as shown and clean down to the bottom of the bead with chisel paring cuts from the front of the post. Next, cut the miters by chiseling from the top edge to the bottom of the bead. Do this in at least two cuts—one to remove the bulk of the waste, and one to clean up. It's a good idea to leave the miter somewhat heavy for later final fitting. Next, I fit the tenon partially into the mortise and draw in a matching miter angle. I carefully pare away on the rail until the two pieces fit tightly. Here, again, cut the miter in two steps. This is finicky work, but not as hard as it looks, and I think it's typical of the elegant, understated details

that appealed to the skilled craftsmen working under the sect's strict guidelines. Before going any further, I dry-fit the base unit together, as shown in the photo above. Because of the number of frame pieces, everything must fit together perfectly before you add any glue, or the real assembly will be a nightmare.

The top unit is an unusual construction, consisting of a separate face frame and a back frame formed by the extended rear legs. The unit's bottom and center cupboard are solid-wood construction. The cupboard is through dovetailed at the top and dadoed to the bottom. I used  $1\frac{3}{8}$ -in.-thick breadboard ends to cap the bottom piece. These oversized ends rest on the top side rails of the lower case and hold the bottom level with the front rail of the upper cabinet face frame. The cupboard back is fitted into grooves let into the sides, top, and bottom. The cupboard also contains a shelf that is housed in dados about one-third to one-half the way down from the top. Tongues on the front edges of the solid cupboard and bottom fit into grooves milled into the back of the face frame. After dry-fitting the unit together and mortising the door frame for hinges (see article on p. 37), I glue up the top face frame and the cupboard and bottom assembly separately. When

**Fig. 3: Carcase construction**

Attach drawer runners, vertical supports, auxiliary strips (shown in blue) after assembling carcase and attaching bottom.

**Frame-and-panel detail**

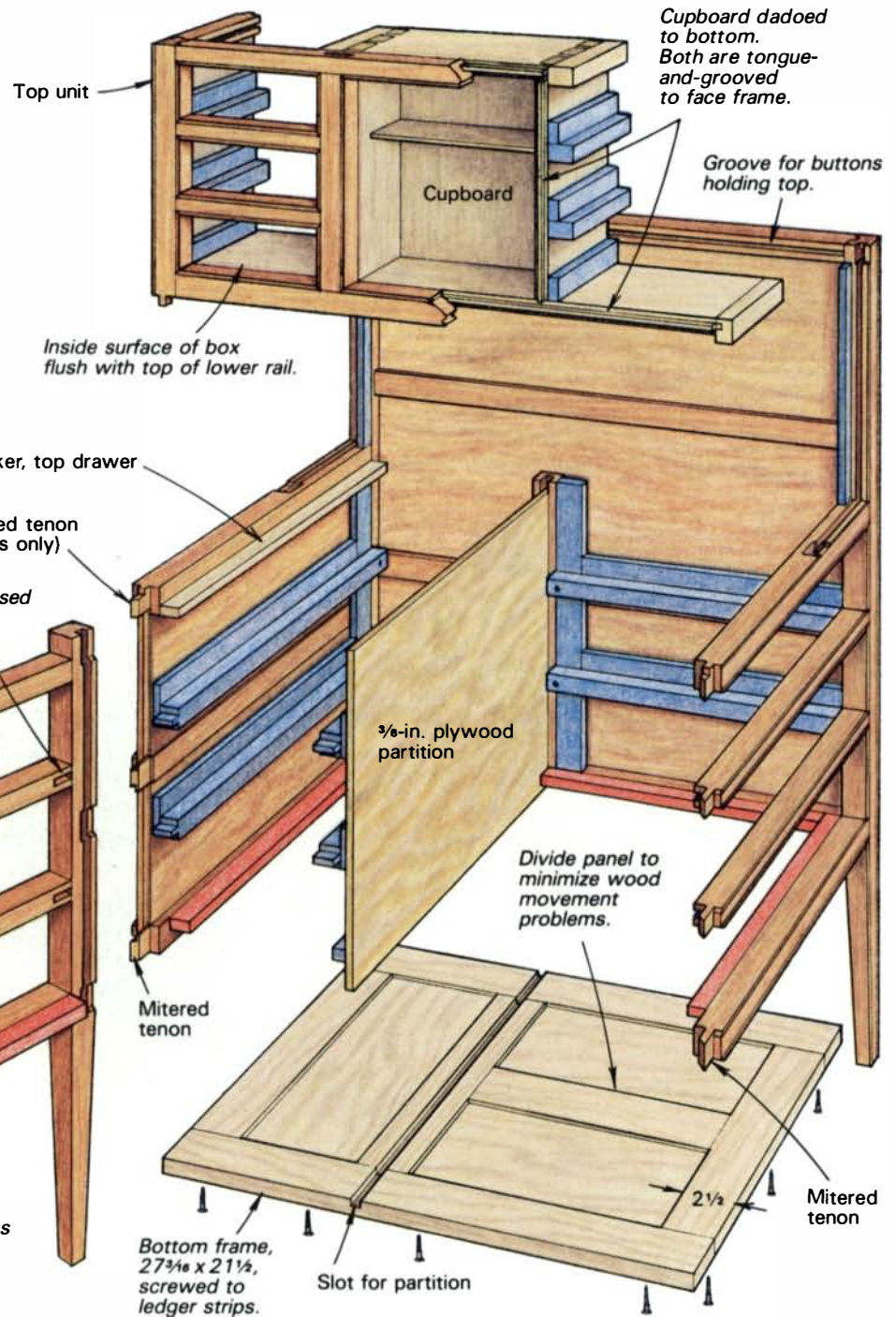
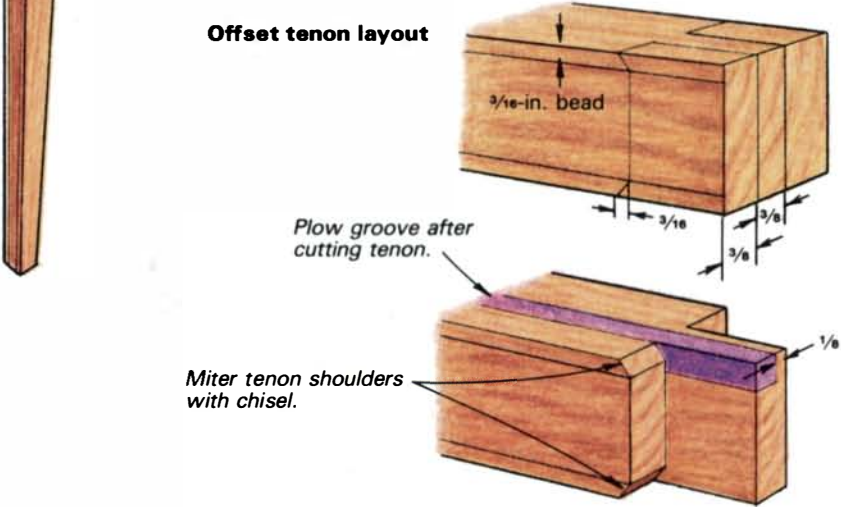
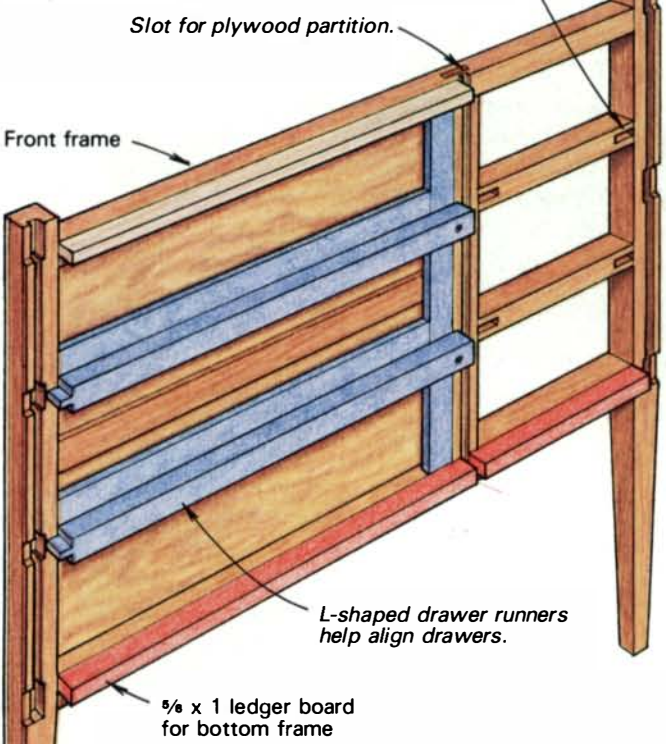
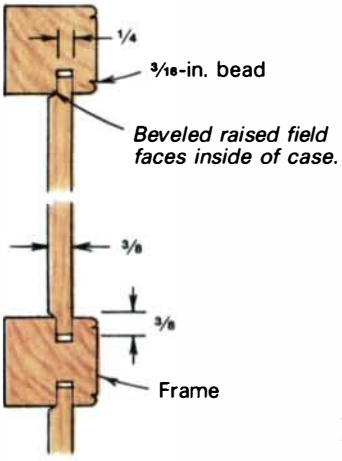

**Mortise layout**

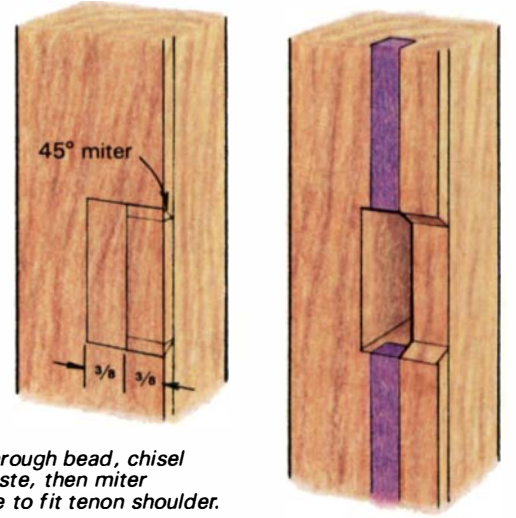



*Shaker designs offer an excellent way to display highly figured hardwoods. The delicately turned legs and gracefully shaped overhang on this bird's-eye maple chest are also hallmarks of the best Shaker work. This frame-and-panel chest is 21 in. deep, with a 3-in. overhang on the front, and 45 in. wide, including a 4½-in. overhang on each side. A ¼-in. bead highlights the drawer fronts and the inside edge of the frame of the side panels.*

the glue is dry, I glue these two together. Assembly of the rest of the piece must wait until the panels are made and fitted.

I resaw the panels from 1½-in. stock, bookmatching and edge gluing the pieces together. I don't worry too much about the actual finished panel thickness, as long as they are all the same. The shaper raises the panels and puts a ¼-in.-thick tongue on all the edges. I aim for a snug fit in the panel grooves at first, then use a pad sander to finish sand the outside faces. Each panel is completely scraped and sanded before assembly. After sanding to 220-grit paper, I also wet the panels to raise the grain and sand again with 220 grit. Doing this now eliminates a lot of the raised grain that will result when I apply shellac to the finished case. I also sand the beading on the frame at this time.

Now I'm ready to glue up the frame. First, I assemble the front and back frames and panels separately, leaving the panels unglued and free to float. After cleaning up these assemblies, I connect them with the side rails, then install the frame-and-panel bottom. Before gluing the already-assembled top face frame and cupboard to the lower case, I install the bottom and the ¾-in.-thick plywood partitions separating the two lower drawer sections.

To install the bottom, I apply a 1-in. by ¾-in. strip around the inside of the carcass, flush with the top of the rails. I mill out a rear sub post to match the front divider and groove it to accept the plywood partition. I position the post against the back rails and screw it in place, exactly in line and square to the front post. I build the frame-and-panel unit as shown in figure 1 from 2½-in. by ¾-in. stock, and push it up from the bottom until it is snug against the applied strip, and level with the lower desk rail. The bottom is screwed to the strips, which also act as drawer runners. Once the bottom is in place, I insert the plywood partition from the top, fit it into the groove I cut in the bottom, and glue it in place. At this time, I also install drawer guides and apply strips to the inside top side rails and front to act as kickers for the top drawers and to support the writing slide.

The tops each have a shallow nosing worked around the edges. The upper top is attached to the frame with 10 buttons let into grooves cut into the top rails. The lower countertop, which is the actual working surface, must be held tightly against the lower rail of the face frame. I used a fixed screw through the side

rail to hold the work surface tight to the upper cabinet and a slot-housed screw in the front end of the side rails. Since the ends of the top extend beyond the front face of the upper cabinet, the back edge of the top must be notched to fit around the cabinet.

The slide-out writing surface is made from poplar edged with 3-in.-wide cherry, mitered at the corners. I edge-glued the front piece to the poplar, but attached the poplar side pieces with wide tongue-and-groove joints glued only at the front end and the first few inches of the panel, and spot glued in the center.

The drawers are next. I fit the fronts to the openings first, again allowing for seasonal expansion by fitting them tight if I'm working in the summer and loose in the winter. Conventional half-blind dovetails join the drawer fronts to the sides, through dovetails join the sides to the back. I've never noticed any standard rules on dovetail angles and spacing used by the Shakers, so I just lay them out to suit my eye. Here I used fairly delicate tails, about ⅜ in. at the widest. Once the drawers have been fitted, I install stops on the drawer runners.

I made the door using standard mortise-and-haunched-tenon joints, but chamfered the edges of the door frame instead of cutting a small bead, as with the rest of the frame elements. A bullet catch with a brass strike inset in the threshold of the door frame keeps the door shut. I also turned a small walnut doorstop and inserted it in the door jamb directly behind the door pull.

I turned ¼-in.-diameter drawer pulls for the lower drawers and ½-in. to ⅝-in.-dia. pulls for the slide, door, and upper drawers. I don't know of any mathematical rules or proportions the Shakers used for their pulls, but over the years I have gravitated to making the length of the pull roughly equal to its largest diameter. This makes a delicate looking pull that feels right to your fingers. I turn six or seven pulls at a time on a single blank. After sawing the individual pulls apart, I mount each tenon in a Jacobs chuck mounted in the lathe headstock, to sand the face of the pull.

After handscraping the chest and sanding it with a pad sander, I applied a thin cut of shellac. I use light coats and build up the finish gradually. I rub down all the surfaces between coats with 400-grit wet/dry silicon-carbide paper. The inside of the case is finished in the same way. The insides of the drawers and the two tops are finished with a 50/50 mixture of oil and varnish. I apply the oil mixture with a brush, let it stand until it's tacky, then rub vigorously with a clean lint-free cloth until it doesn't look wet anymore. Do small sections, a couple of square feet at a time, since the mixture dries rapidly. Apply enough coats to build a film roughly as thick as the shellac. When I'm satisfied with the finish, I wax the surfaces and polish. I think these two finishes are very compatible. I'm particularly fond of the look of a good shellac finish, but think the oil/varnish mixture is better for areas subject to abuse or water and alcohol.

I am continually amazed by the quality and beauty of the original Shaker pieces, and by the inspiration they offer modern workers. And, they are challenging enough to interest even the most accomplished craftsman. Shaker designs also provide a way to display the most beautiful, highly figured woods without detracting from the beauty of the piece itself. So good is the design that, no matter what the decor of your home—modern or traditional—a Shaker piece seems to fit right in. □

*David Lamb builds Shaker-inspired traditional and contemporary furniture at 370 Shaker Road, just down the road from the Canterbury Shaker Village. For information about visiting the village, write Shaker Village Inc., Canterbury, N.H. 03224. The village is open from mid-May through Columbus Day.*

# Hanging a Cabinet Door

## *Swinging with brass butt hinges*

by Roger Holmes

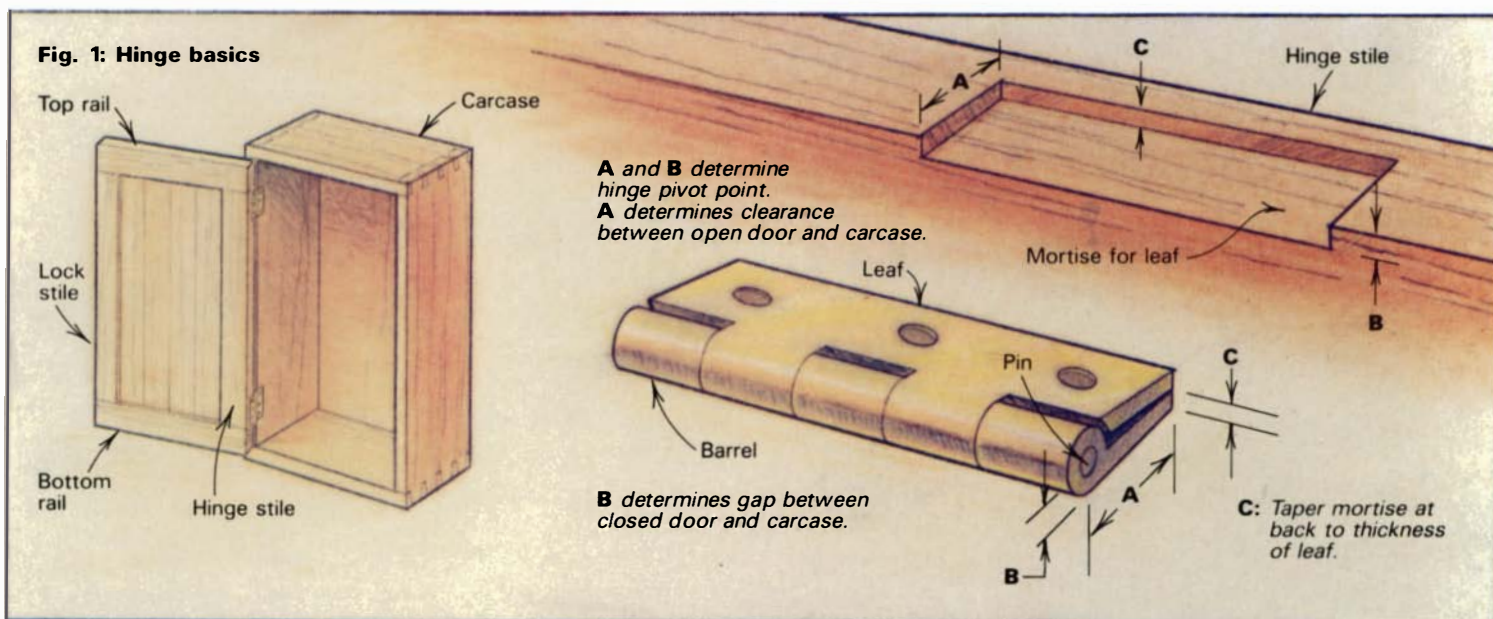

**H**anging a cabinet door well is as important as making it well—unsightly gaps, a sloppy fit or a sticky door can ruin the effect of the loveliest wood and most meticulous joinery. You can hang a door with anything from interlocking clenched nails to space-age plastic inserts. Solid, extruded (or drawn) brass butt hinges have a nice look and feel, and I prefer them for most quality work. Accurate layout and a careful, step-by-step approach are essential to making butt hinges work properly, as well as look nice. Although I will describe how to hang a flush door (one hung inside the carcass, flush with the carcass edges), the steps are much the same for butt-hinging other types of doors, too.

You may have a little trouble finding extruded hinges. Most hardware store brass hinges are stamped or pressed from a single sheet, and the hinge barrels are bent around the pins. Although these hinges are cheaper than the extruded ones, their leaves are thin and often rattle around the pin. Extruded hinges, made by forcing hot brass through dies shaped to the desired cross-section, are generally heavier, tighter and sturdier than pressed hinges. (Extruded brass hinges in a variety of sizes are available from Garrett Wade, 161 Avenue of the Americas, New York, N.Y. 10013.)

Hinges are commonly described by their height and open width, in that order. A 2-in. by 1½-in. hinge, therefore, has leaves ¾-in. wide, measured to the center of the barrel. The width of the hinge needed for each door depends on the thickness of the

door stile and width of the hinging surface on the carcass. You can figure widths on a full-scale drawing or by trying various hinges against the door itself. If you want a rough general rule, double the thickness of the stile (or carcass surface if it's narrower) to get the hinge width. A ¾-in. door, for example, can accommodate a 1½-in.-wide hinge. The barrel protrudes beyond door and carcass, allowing the door to swing open and making room for a stopped mortise, which hides the edge of the hinge from view on the door's inside face. Long hinges give more support, for obvious reasons, but balance length against looks—I seldom use hinges longer than 2 in. on all but the largest cabinets.

The leaves of extruded hinges can be rectangular in section or tapered. A tapered hinge is lighter for the same strength, but the difference is insignificant for cabinet-sized hinges; there are only minor differences in installation. Most cabinet butts I've found have been tapered. I recommend fixed-pin hinges for cabinet doors; the convenience of loose-pin hinges, which can be disassembled during installation, is outweighed by the sloppy fit of pin to leaves.

I use two butt hinges for most cabinet doors, adding a third in the middle of doors over 30 in. high. The position of the top and bottom hinges is mostly a matter of taste. I usually try to line them up in some way with the top and bottom rails of frame-and-panel doors. The middle hinge isn't necessary for strength as much as to keep the center of the hinge stile from moving slight-

**Fig. 2: Hinge geometry**

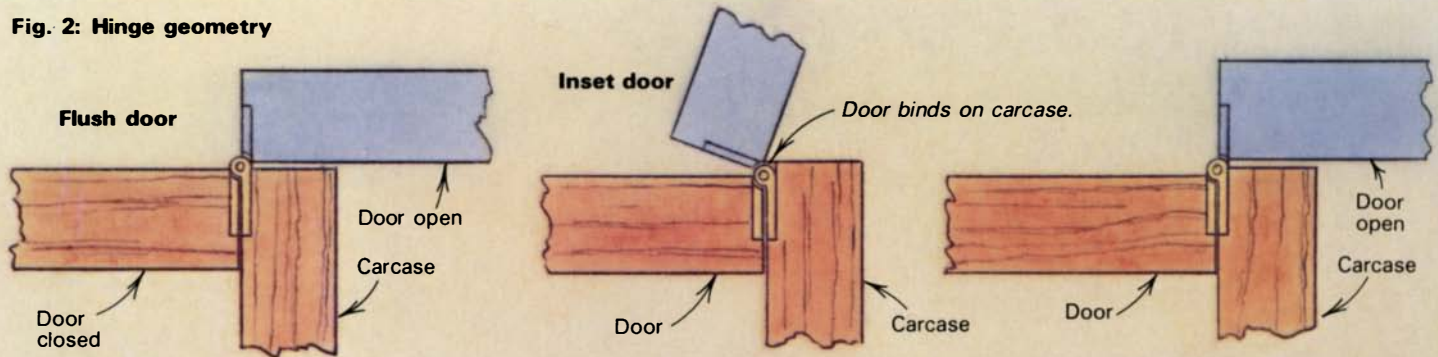

For a flush door to open 180°, position the centerline of the hinge barrel outside the plane of the carcass front.

A door set slightly back in the carcass will bind unless the leaf on the door's hinge stile is offset slightly to move the barrel centerline outside the carcass, as shown above.

**Fig. 3: Mortise layout**

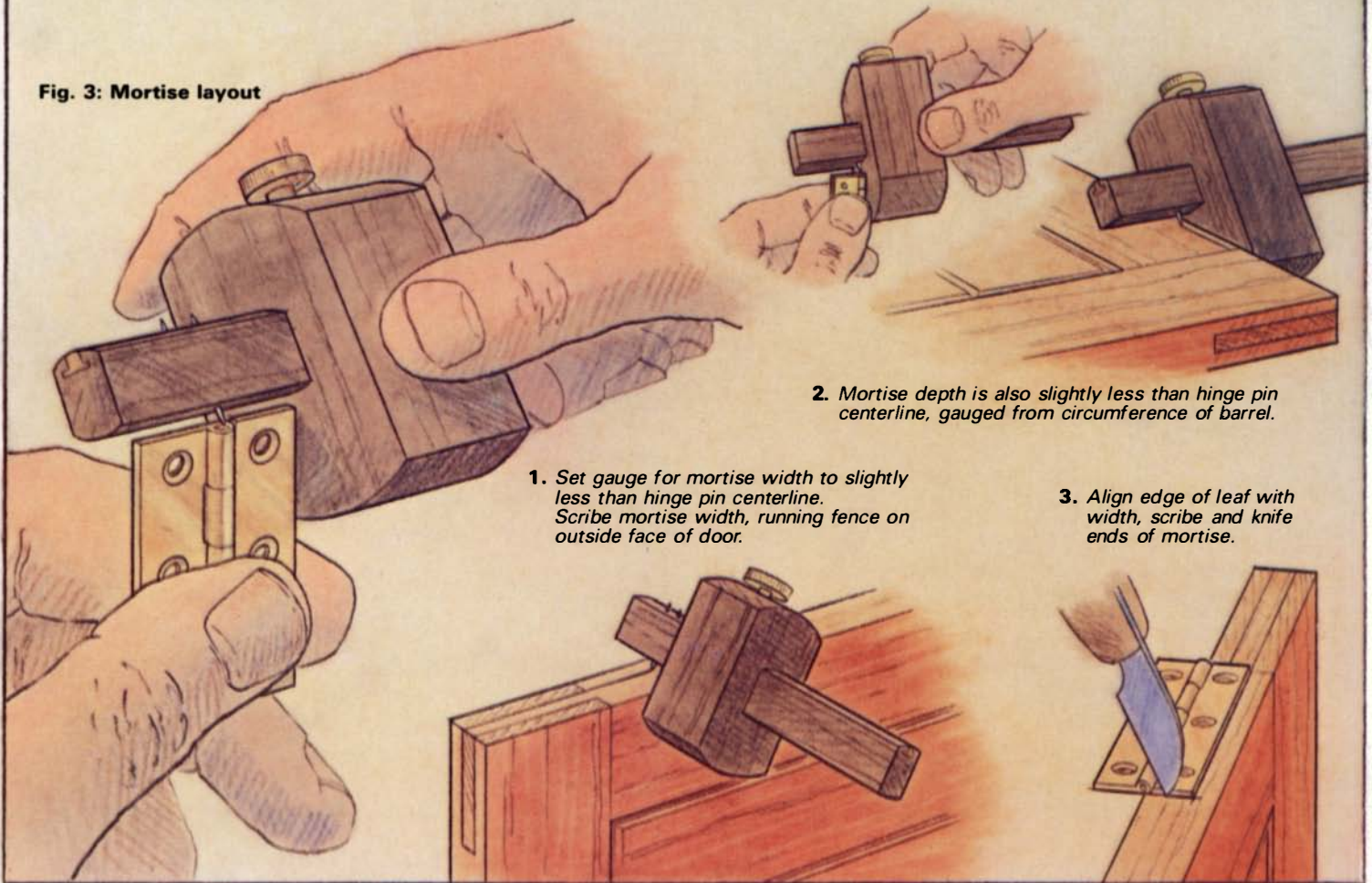

1. Set gauge for mortise width to slightly less than hinge pin centerline. Scribe mortise width, running fence on outside face of door.

2. Mortise depth is also slightly less than hinge pin centerline, gauged from circumference of barrel.

3. Align edge of leaf with width, scribe and knife ends of mortise.

ly and binding the door. A center hinge can help to pull a slight bow out of a door, too. The position of the centerline of the pin, which is the pivot point of the hinge, determines how far the door will open, as shown in figure 2. A full-scale section drawing through door, hinge and carcass will help determine hinge position—rotate the hinge on a push-pin pivot to see how far the door will open.

I think a well-fitted door should show a uniform gap between it and the surrounding carcass. It should open smoothly, without binding or sticking. For doors that won't expand or contract much with changes in ambient humidity, such as frame-and-panel or veneered doors, I shoot for gaps of  $\frac{1}{32}$  in. all around; more if I'm hanging the door during the dry season. The larger the door, the greater the gap should be. You can vary the size of the gap between hinge stile and carcass by varying the depth of the mortises

for the leaves. Making the mortises half the diameter of the barrel (the centerline of the pin) will bring the stile flush to the carcass. Shallower mortises give greater clearance. The barrel diameter of most cabinet-size brass butts is greater than the combined thicknesses of the two tapered leaves. A closed hinge will, therefore, taper. To make a neat job, I taper the mortises from front to back so that the back edge of the hinge will be flush with the surface.

**When you build the carcass**, make it as square as possible, especially at the door opening. Sight over the carcass or frame around the opening, as you would over winding sticks, to check for twist, and plane off high spots. Make the door slightly larger (at least  $\frac{1}{8}$  in. overall) than the opening. Then, regardless of the type of door—frame and panel, veneered, board and batten—make sure it's flat. It's virtually impossible to correct all but the

slightest of twists during hanging. Check for twist by rocking the door on a flat surface or by sighting over winding sticks. A slight twist can be planed out, but if you find yourself thinning the door down appreciably to remove a twist, make another door.

Next, fit the door to the opening. First plane the edge of the door's hinge stile flat and square to the door's face. Try the door to the opening, pressing the hinge stile against the carcass side and the bottom rail against the carcass bottom. Plane off the wood necessary to make the bottom rail conform to the carcass. Try the door to the opening again, then plane the top rail to fit; repeat for the final stile. The order isn't important, as long as the result is a door that slips into the opening with very little play up or down. You can plane the door to create the clearance now and hang the door using shims—small pieces of card or veneer as thick as the desired gap—inserted between door and carcass. I prefer to hang the door first, then plane for clearance.

After determining the position of the hinges, I mortise the door first. (I'll describe fitting a door flush with the carcass, a fine gap all around. Alter the marking gauge settings to suit your taste.) Put the door hinge-stile-up in the vise, set a marking gauge from the edge of the leaf to just shy of the pin centerline. This locates the pivot point outside the carcass and allows the door to open 180° (figure 2). Mark the edge of the hinge stile at the hinge locations, running the fence against the outside face of the door (figure 3). Set another gauge for the mortise depth; again, just shy of the pin centerline. The amount by which the setting is shy of dead center equals half the finished gap between door and carcass. (Two gauges are useful for hanging a flush door, as the settings are the same for laying out the mortises on the carcass.) Scribe this setting on the face of the door at the hinge locations. Position the hinge on the door, its long edge aligned with the first gauge mark and knife against its ends. This ensures a snug fit in the mortise—the ends of few hinges are exactly square to the edges.

Now chisel out the waste. I carefully score the gauged and knifed lines with a sharp chisel, then make a series of chops, as shown in figure 4, along the length of the mortise, about 1/2 in. from the scored outlines and as near the final depth as possible. The chops break the wood fibers and make it easy to clean to the bottom of the mortise by paring with a wide chisel. Finally, slice down to establish the outline and try the hinge in place.

I fix the hinge through only one hole at this time, in case it needs adjusting later. Centering screws in hinge holes can be terribly frustrating, particularly in open-grained woods. I position the hole with a carefully placed awl and a steady hand. Deepen the hole with the awl when the position is right, to keep the pilot-hole bit from wandering. I place the screw just off-center toward the back of the mortise, so it will pull the hinge tight. It is prudent to use steel screws during fitting. Brass screws have an infuriating tendency to twist off; steel screws prepare the way for the final installation with brass screws, thereby avoiding much gnashing of teeth.

Next, fold the hinges shut and slip the door into the carcass; the lock stile won't go in all the way because of the hinges. Knife the positions of the hinges on the carcass side (figure 5). If you've already planed for clearance, place the shims before knifing. Remove the door and gauge the mortise width and depth on the carcass. Align the hinge with the knifed position marks and knife the mortise ends, as for the door. It's most convenient to chop and pare the mortises with the carcass side supported on the workbench.

Now screw the door to the carcass, one screw to a leaf. I plane

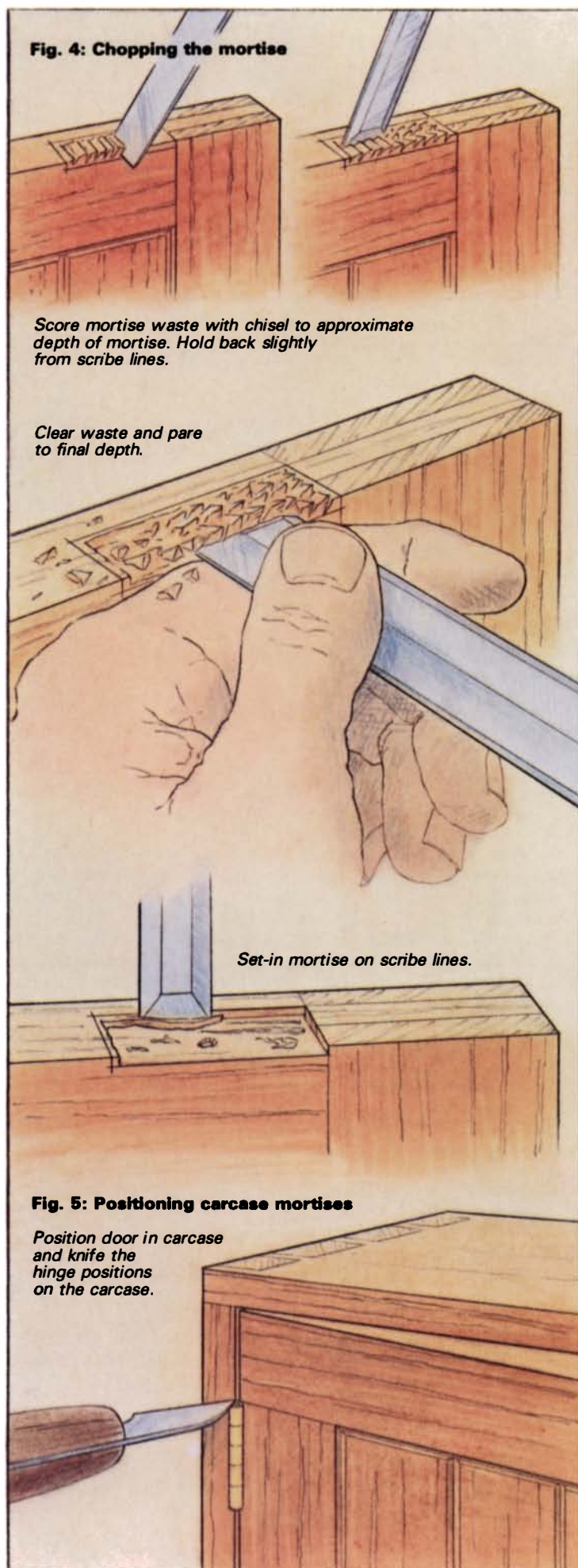

clearance on the lock stile first, beveling the edge back from the front to allow for the radius of the swing. Then plane top and bottom rails. You'll probably have the doors on and off two or three times to do this, so remember to use the steel screws. Uniform gaps make a single door look good and a row of doors look even better, so it's worth a little extra trouble.

Though attractive, simple and durable, butt hinges aren't built for adjustment. Vertical movement is impossible without plugging screw holes and extending mortises. You can adjust the gaps by packing out one or more hinge mortises with paper, card

or veneer shims. You make a slight twist in a door less noticeable by adjusting the width of a mortise. If, for example, the bottom of the lock stile is set farther back from the carcass edge than the top is, widen the top carcass hinge mortise. This will pull the top of the hinge stile in and push the bottom of the lock stile out. This is just a balancing technique, evening the twist out around the door; it can't be relied upon to take the twist out of the door. □

Roger Holmes is an associate editor of *Fine Woodworking*.

## Router mortising Soss hinges

by C.B. Oliver

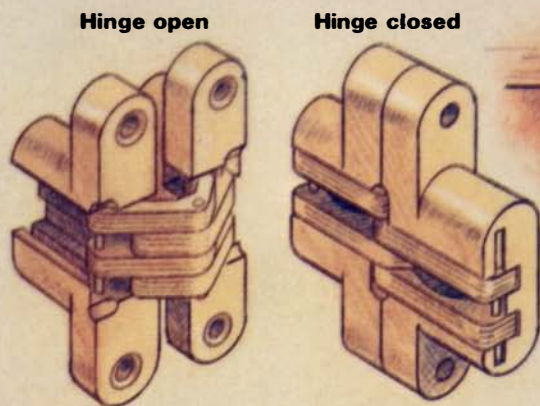

All mortise dimensions must match hinge dimensions exactly, except for A and B, which can be slightly deeper and longer. Rout deep mortise for hinge body first, then shallow mortise for flange.

Soss invisible multi-leaf hinges, which have been used by commercial cabinet-makers for years, can be a good choice if you don't want to clutter up an understated design with exposed hardware. Soss hinges range in size from ½-in.-dia. cylinders to 5½-in. long hinges for entry doors, and even the smallest are extremely strong. (Soss provides a chart for proper hinge selection.) In addition to doors, Soss hinges can be used for table leaves and desk tops, boxes and so on. Also, the hinge bodies are radiused, so no follow-up chisel work is needed if you mortise with a router or a drill press.

Plunge routers are real slick for installing Soss hinges. For flush-door face-frame construction, I mill the hinge mortises in the hinge stiles of both door and frame before gluing up, as shown in the drawing. To allow for inaccuracies, make the door a little larger than the opening, then plane it to fit once you've hung it. You could make up a mortising jig similar to the one Tage Frid wrote about in *FWW* #30, but the fence on any good plunge router will work fine as a guide. (Soss includes a template to position the hinges in from the door and frame faces.) I clamp the door stile to the carcass side or face rail face-side-out, then mount this entire assembly in a bench vice.

Router in two steps by making a deep, short mortise for the hinge body, and a shallower, longer one for the mounting flange. The bit radius must match the ra-

dius of the hinge flange you're using. With the router's fence held firmly against the stock, mill the deeper mortise first. Keep the bit from wandering by always moving the router against its rotation. The length of the deep mortise is not critical; in fact, if it's a little too long, final fitting is easier. Place the hinges in the deep mortises, position them where you want them, and mark the position of the mounting-flange ends with a knife. Set the router to the flange thickness and mill the longer mortise. Instead of devising stop blocks to fix the length, I "creep up" on the marks. Work slowly—it is a lot easier to lengthen the mortise than it is to shorten it.

The method shown here will also work with routers that do not have built-in plunge mechanisms. Mill the deeper mortise in two or three passes by holding the router's fence against the work and lowering the bit slowly at an angle until the base rests firmly on the edges of both clamped parts. To ease the cutting load, you can waste most of the mortise on a drill press or with a portable drill guided by a dowel jig. □

C.B. Oliver makes furniture in Nottingham, N.H. Soss hinges are available from Builders Specialty & Hardware Corp., 26 Weston Ave., P.O. Box 325, West Somerville, Mass. 02144, or you can write Soss directly at Box 8200, Detroit, Mich. 48213.

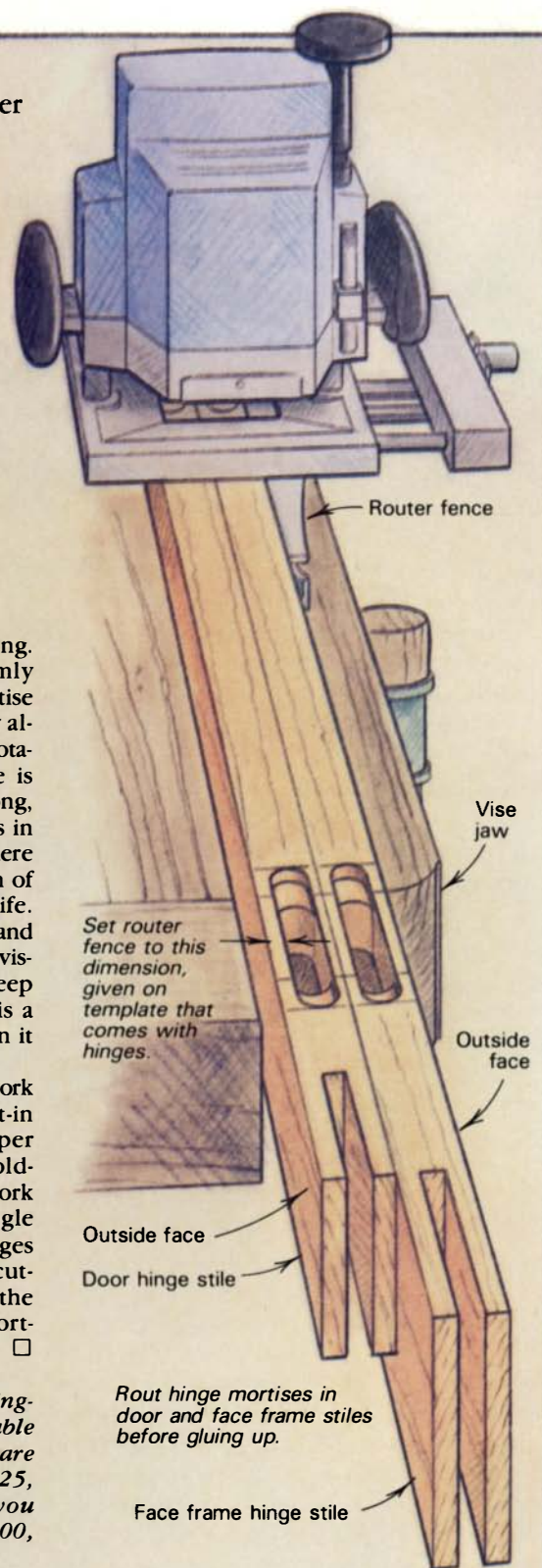





*Walnut drops its leaves early in the fall, silhouetting its stark, open crown. It is a messy lawn tree, producing catkins in spring and large leaves—along with bushels of nuts—in autumn. In contrast to this open-field tree, a woods-grown walnut reaches for sunlight, resulting in a long, clear trunk, but the most recent 10 to 20 years of growth will be light-colored sapwood.*

# Walnut

*The cabinetwood par-excellence*

by Jon Arno

In lists of the various properties of cabinetwoods, American black walnut, *Juglans nigra*, stands near the middle in every category. There are dozens, if not hundreds, of woods that are stronger and denser. There are a few woods with better figure and richer color. Some hardwoods are substantially easier to work than walnut. And many fine cabinetwoods are a good deal less expensive.

Yet walnut is so flexibly appropriate for a broad range of uses that, overall, it rivals any other wood in the world. It might, in fact, be the very best cabinetwood of all. What does walnut bring to the party that causes it to stand out? To answer this question, we must consider not only its physical properties, but a number

of subtle things that appeal to other senses and to our emotions.

Take gunstocks, for example. Of the four woods commonly used, only walnut is rated "excellent" in the physical attributes a gunstock requires. It has been the favored gunstock wood since colonial times, long before laboratory testing could confirm our pioneers' instincts. The substitutes, hard maple, yellow birch, and sycamore may surpass walnut in one or two respects, yet, in the final balance, walnut becomes the standard, the perfect gunstock wood. In weight it is heavy enough to absorb some recoil, yet not so heavy as to be arm-wearrying. For its weight, it is outstanding in strength, hardness and shock resistance. It is stable enough not to endanger the precise alignment between metal

and wood. It machines beautifully. Walnut's dark color, aesthetics aside, is a particular asset—the runners-up all require staining lest they be conspicuous in the field, and are, therefore, more difficult to touch up if dented or scratched.

Notice how many of these attributes are also desirable for furniture. In the gamut of cabinetwoods, there are only a handful of woods as well endowed. In addition, walnut is neither ring-porous like oak or diffuse-porous like maple. It is what most experts call "semi-ring-porous," with a gradual transition between earlywood and latewood. This helps to make for little, if any, chatter in its resistance to the cutting edge, allowing shavings to peel off with a wax-like roll. Walnut has adequate ring-porosity to show a beautiful grain pattern, but is diffuse-porous enough to make the use of fillers optional in most furniture applications—if unfilled the pores will show but not be objectionable.

In walnut, we have a wood that is not too hard, not too soft, not too open-textured, not too plain . . . not too anything (except maybe too expensive). Like Baby Bear's porridge, it's just right.

I suspect that walnut has been so long entwined with human history that we have developed a genuine emotional attachment to it, one that runs deep. Walnut of the English or European variety, *J. regia*, has been with us both in our cabinetmaking and in our diet since ancient times, when our ancestors imported the tree from the Middle East and reestablished it in western Europe, where it had been extinct since the last ice age. In the 1600s,

European walnut supplanted oak as the premier furniture wood, until it, in turn, was supplanted by Honduras mahogany. During the American colonial period, when mahogany furniture imported from England was in style, walnut was sometimes stained red by domestic cabinetmakers in an effort to emulate the imports. It could be argued that, in Europe, mahogany is still the standard by which other cabinetwoods are measured. Yet in America this has not been the case for a long time. Today, we take Philippine "mahogany" (lauan and other species of *Shorea*) and stain it dark brown to imitate the walnut that is closer to our hearts.

Strictly speaking, current style is an intangible. Walnut has other intangible features as well. Particularly high on such a list is the pleasant aroma of a piece of walnut as it passes through the planer or the tablesaw. I am abnormally fastidious about keeping my shop clean because I know a clean shop is a safer shop. In fact, I will sometimes stop in the middle of a project to sweep the floor, but I have been known to let walnut shavings lie for days. To me, the scent of walnut ranks with fresh-ground coffee as one of life's great treats. Under certain conditions, however, particularly when a carving block of unseasoned walnut has been set aside to dry slowly, thriving micro-organisms can imbue the wood with a lasting, sourish odor best described as a stink. Even so, it helps clear the sinuses.

I should defer to the medical profession on this topic, but the reason the aroma of walnut evokes such pleasant emotions and a

---

## About the other walnuts

My vote for the royal family of cabinetwoods must be *Juglandaceae*. This botanical family includes *Carya*, the hickories (including pecan), and the true bluebloods of the line, the *Juglans*, which are the walnuts and butternut. There are broad differences among the *Juglans* species, but most walnuts overlap so much in color and density that you may have to examine cell structure to tell them apart for certain.

The walnuts and the hickories comprise some 50 or so species worldwide. The hickories are limited to eastern North America and southern China, while the walnuts have a broader range in North America, Central America and northern South America, as well as in Eurasia.

The wood of the old-world tree, *J. regia*, is slightly softer and lighter in color than our black walnut, *J. nigra*. European walnut also shows subtle differences resulting from the climate and soil where it has grown, and for marketing reasons may be called French, Balkan, Italian, etc., but it is all the same species. Very little solid stock escapes Europe, although the veneer called circassian burl is sometimes seen on the market here.

Black walnut is not our only domestic species—there are *J. major*, or Arizona walnut, and *J. microcarpa*, which is called little walnut, Texas walnut or nogal. Occasionally, wood from the several species of walnuts from South and Central America shows up, called either tropical walnut or nogal. These are beautiful woods, a little softer, a little coarser textured and somewhat darker than our black walnut, judging from the few samples I have seen. These species are true walnuts, unlike African walnut (*mansonina*) and Queensland walnut, which have borrowed the name but not the pedigree.

The several Oriental species of true walnuts, native from northern India to Japan, produce woods that are almost never seen in our market. I haven't worked with Japanese walnut, *J. cordiformis*, but it is reputed to have a warmer, yellowish hue than our native wood.

Butternut, *J. cinerea*, is our other major domestic species of *Juglans*, and one of my personal favorites. While butternut is somewhat coarser in texture, its figure is virtually the same as black walnut. If you have ever wished there was a wood that worked as easily as pine or basswood yet looked like walnut, butternut is as close as you will ever get. With an average specific gravity of only 0.36, it is actually less dense than Ponderosa pine at 0.38 and substantially less dense than black walnut at 0.51. At the extreme ends of the scale,

though, the hardest, darkest-colored butternut and the softest walnut can be difficult to tell apart. Yet even then, butternut tends toward gray-tan and gingery tones, while walnut shows more purple.

Butternut has prevalent tension wood and tends to fuzz up a little in sanding. Being soft, it will generally drink an extra coat of varnish before it fills to a polishable surface, and it will not endure as well in daily use—this may be important if you are making a table, but it's almost irrelevant for a mantel clock or a picture frame.

Finally, claro walnut is a term used freely by lumber dealers on the West Coast, usually to describe highly figured walnut harvested from overmature trees in nut plantations. Some of this wood is probably English walnut that was grafted to a native rootstock, a practice that can promote a flame figure low in the stem. Other possibilities are two species native to California, *J. hindsii* and *J. californica*, found respectively in the northern and southern parts of the range. All of these claro walnuts are true *Juglans*, but the name is no guarantee of which species the walnut is, nor that it is particularly showy. I suspect at this point that I'm just splitting hairs. Let me affirm that in the walnut family tree there are some beautiful dark woods but no black sheep. I, for one, will welcome walnut under any name in my shop—none of it is what you could call bad. —J.A.

sense of well being may be more than psychological. According to a USDA Forest Products Laboratory publication, walnut contains ellagic acid, a sedative and tranquilizer. They report an incident in which a dog chewed on a black walnut statue and fell into a deep sleep for two days. There are also reports that various tribes of American Indians used to throw crushed walnuts or butternuts into ponds to stupefy fish.

Walnut's chemical potency should come as no surprise to gardeners. One of our native black walnut's most active constituents is a substance called juglone, which is apparently part of the tree's biological defense system. Juglone is toxic to other plants, such as apple trees, and especially to members of the tomato family. It would appear to pose no problem to cabinetmakers, however. It polymerizes into dark pigments in the wood tissue, which, I presume, makes it inert.

One of the walnut tree's few shortcomings is that it produces logs with a relatively large amount of almost pure white sapwood. Slicing it all off would be an appalling waste. Fortunately, by injecting hot steam into the kiln during the drying process, the sapwood can be darkened somewhat. This procedure is certainly beneficial in view of our limited supply of walnut, but it seems to dull the richness of the wood's overall color. To my way of thinking, there is something special about a piece of carefully air-dried walnut with its subtle, almost translucent blue-purple highlights. Unfortunately, like flowers, youth, and so many of this world's beautiful things, the magic of a freshly planed piece of air-dried walnut is a fleeting pleasure. Age and exposure to light will bleach its vivid tones, and over the years the strikingly blue-purple highlights mellow out toward the gold or amber side of the spectrum.

As far as price goes, I wish I could offer some novel schemes for scavenging a deal on this stuff, but there aren't any. Even the small backwoods sawmills know what walnut is and what it is worth. Black walnut generally runs between \$3 and \$5 per board foot, depending upon the grade, and butternut (see box, facing page) usually costs about \$1 less per board foot. The problem is, there is no such thing as an inferior species of walnut and everybody knows it. There is no compelling reason for walnut to be in scarce supply other than the universal demand for it. As it is, the demand makes the wood of this relatively plentiful tree seem scarce.

Walnut is a pretty tree with its deep brown, almost black bark and its bright light green compound leaves, but it is a beauty that belongs in the forest where competition for sunlight forces it to produce a tall, unmarred trunk. In this setting it is a capable competitor and will develop diameters in excess of 5 ft. and heights of 100 ft. or more. In the open, like most hardwoods it has a propensity to branch out, forming a dome-like crown which much reduces its value as a timber source.

Although its crop of tasty nuts is an important asset, the tree is not that popular for landscaping. Because walnut leafs late in the spring and loses its leaves early in the fall, its appearance is stark and dead looking for much of the year. There is no particular beauty to its flowering, it is a catkin producer, and a messy tree on a well-manicured lawn. Its nuts attract squirrels that are generally more skillful in collecting the crop than all but the most watchful homeowner, and add injury to insult by planting a few of them in gardens where they are chemically hostile to other plants.

While we woodworkers might unanimously agree that walnut plantings should be sharply increased, the economics of growing hardwood timber on valuable eastern land is, pardon the pun, a

---

## Making walnut-husk stain

The pigments in all parts of the walnut tree are plentiful and, for better or worse, downright indelible. Anyone who has tried to husk walnuts by hand knows all about the durability of this stain. Even crushing the fresh leaves with bare hands will leave you with a dirty, two-pack-a-day, yellow stain on your fingers that defies a scrub brush. The pigments in the husk of the nuts and the root bark make excellent dye for cloth and, of course, they give the wood its much prized color. In the case of American black walnut, this is the well-known and often strikingly purple-streaked chocolate brown.

Those cabinetmakers with a flair for experimentation can get at this pigment and produce a stain that will transfer some of walnut's beauty to other less-endowed woods. To begin, collect a few pounds of the nuts, preferably those that have fallen to the ground and are beginning to darken and decompose. Husk them and loosely pack a quart jar full of the husks (sans the nuts—eat those). Fill the jar brim-full with non-detergent ammonia, the ordinary sort, not the sudsy kind.

Cap the jar and allow it to stand for a few weeks. The ammonia will leach out the pigment, and this mess can be strained through cheesecloth to produce a jet black liquid that, admittedly, is something of a trial to work with. Wear rubber gloves and apply the stain with a rag in a well-ventilated work space, preferably outdoors. The stain is water based, and two coats are generally necessary because the first coat raises the grain and must be rubbed down with fine sandpaper or steel wool.

It's a foul-smelling, messy process, but it works, and I promise that the results are definitely worth the trouble. —J.A.



*Walnut-extract stain, best made from decomposing husks, is excellent for darkening mahogany, and produces a patina on pine that continues to darken with age. Woods shown, from front to rear, are poplar, pine, mahogany, cherry and maple.*

---

tough nut to crack. But contrary to popular opinion, on good sites walnut is not a slow grower. It spurts up rapidly for the first decade or so and then begins to slow down as it enters into nut production. The tree seems to oblige us woodworkers with the reasonably quick accumulation of woody tissue, but then it taunts us in taking its own sweet time mellowing it into the rich brown heartwood we seek. □

---

*Jon Arno is an amateur wood technologist in Milwaukee, Wisc. He is currently seeking information from other woodworkers about the properties and working qualities of unusual native woods.*

# More on Bandsawn Veneer

*Getting the most out of your precious planks*

by Paul Harrell and Monroe Robinson

In *FWW* #51, Brad Walters and Richard Barsky suggested a single-point fence for bandsawing thick veneers from a plank. Here is another method that we use at the College of the Redwoods. Instead of a single-point fence, we use a long, straight fence and fine blades to saw veneer to the finished thickness right off the saw, without planing or sanding. This gives more usable wood from a plank and it minimizes pattern changes from one veneer to the next.

Where Walters and Barsky recommend a wide, stiff blade, we prefer a narrower one. For sawing narrow veneers (up to 4 in. or 5 in.), we use a ½-in. blade with 6 teeth per inch and very little set. While this blade has limitations and is definitely not for production work, it will give the maximum number of veneers from a plank. For wider planks and resinous woods that may gum the blade, we use a skip-tooth blade with 3 teeth per inch and moderate set. A blade with too much set wastes wood because of the large kerf, and it leaves a ragged surface. With these blades, we get six to eight veneers per inch of plank. We rip wide boards before sawing the veneer. After sawing, the veneers are edge-joined to restore the full width. This produces a better surface with less waste than trying to saw 8-in. or wider planks.

Bandsaw blades almost always have some degree of drift or lead, that is, they won't cut straight if the board is fed at 90° to the front of the table. Drift is constant, so we adjust the rip fence to compensate for it. To find the drift of a particular blade, you will need a bevel gauge and a piece of wood approximately 2 ft. long and thick enough to offer some cutting resistance. Joint one edge of the board, then, with a marking gauge, strike a line on a perpendicular face of the board. With a slow, steady feed, start cutting down the line and try to find the angle of presentation that results in a straight cut. When you are sawing down the line easily without having to make any adjustment, switch off the saw and hold the board in place until the saw stops. The board is now positioned the way the saw wants to cut. Set your bevel gauge to the angle formed by the intersection of the board's jointed edge and the front edge of the table. Don't be surprised if the drift angle is 5° or more off the perpendicular.

Use the bevel gauge to set the fence angle. Position it as far away from the blade as you want your veneer to be thick, then clamp it at both ends. For most surfaces, we use a ¾-in. finished thickness. This is a very general rule, though. Vary the thickness to suit your application. Thick veneers from dense hardwoods, like ebony or rosewood, can exert stress on the core causing warping or cracking, so we cut these ¼ in. or less. A veneered

lid for a jewelry box laid up on a ¼-in. core, for example, will be more stable with ¼-in. veneers.

We make our fences from Baltic birch plywood faced with plastic laminate to reduce friction and provide a long-wearing surface. It's good to have several fences of different heights. A 6-in. fence for wide boards, and a 3-in. fence for narrower ones will allow the upper blade guides to be brought down close to the work.

When sawing with a properly set fence, you don't have to steer the work at all. Apply steady feeding pressure with your left hand while your right hand pushes the work against the fence just in front of the blade. The smoothness and rate at which you feed is crucial. With a little practice, you can tell from the sound and feel of the saw if you are feeding too fast. The kerf will become erratic and wider if you are forcing the work. Going too slow can cause problems too (burning and wandering) and stopping in the cut almost always results in an uneven veneer. Try to maintain a smooth, steady feed from start to finish. If you're getting uniform veneer, there's no need to surface plane the board between cuts. Minor irregularities can be handplaned before the next cut. A smoothly bandsawn surface is adequate for gluing, and the show side will be handplaned after the veneer is glued to the core.

To edge-glue the veneers before pressing them, we handplane the edges on a shooting board, similar to that described by Ian Kirby in *FWW* #47, pp. 37-39. If you are going to make a veneer shooting board, make it with an inclined ramp for the work to rest on. This will allow a fuller width of the plane iron to cut on each pass. To get the best control over pattern matching, we plane one veneer at a time, removing the minimum wood from each. Once matched, we glue up the veneers in the jig shown in figure 1. Ten or fifteen minutes in the jig is long enough for the glue to set, during which time you can shoot the edges of two more veneers.

The process of fine veneer work is time consuming and so should be used when it offers possibilities that justify the extra effort. When deciding whether to use veneer or solid, remember each demands a different style of construction and each gives its own feel to a piece. The clean, refined lines veneer imparts may be ideal for a piece like the cabinet shown here, but on a kitchen table that will get hard use, a solid wood top may better suit both the style and the use of the piece. □

---

*Paul Harrell and Monroe Robinson are graduates of the College of the Redwoods woodworking program taught by James Krenov in Fort Bragg, Calif.*



Paul Harrell



Most bandsaws lead or drift to one side when cutting. To compensate, saw a test piece, angling the board until the cut is effortlessly straight. Stop the saw, set a bevel gauge to this angle and use it to position the fence to allow for lead. Fences are of Baltic birch faced with plastic laminate. To edge-glue sawn veneers, Robinson, above, uses a shooting board with an inclined ramp to joint the veneer edges. Veneer surface is smooth enough to glue to a core without planing or sanding.

Fig. 1 Glue-up Jig

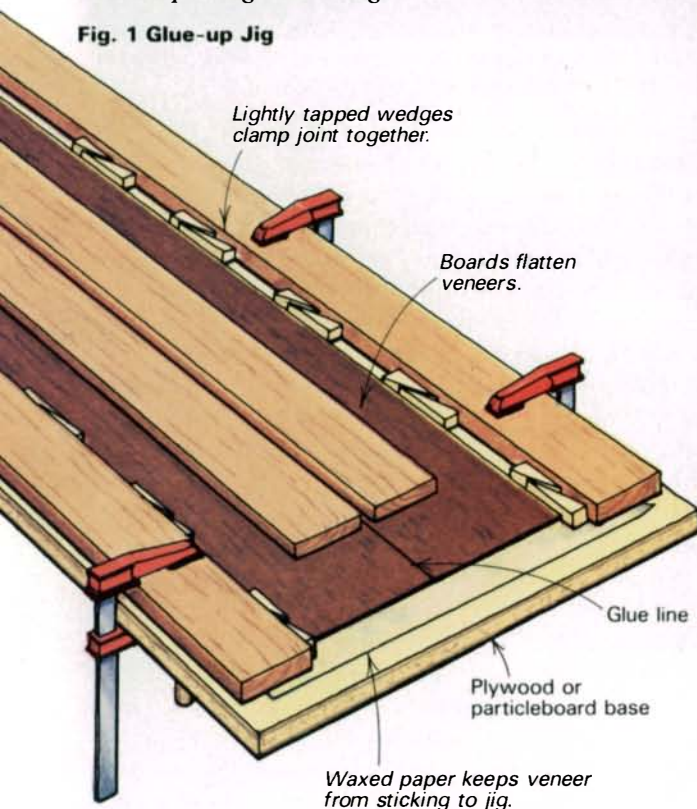
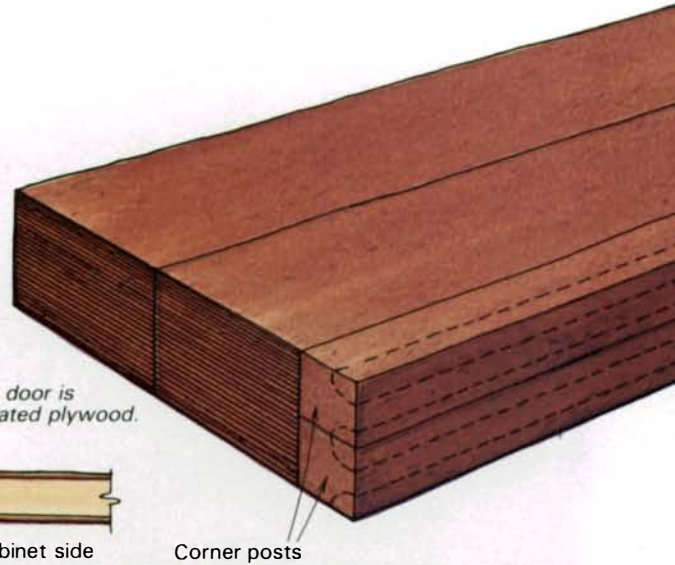
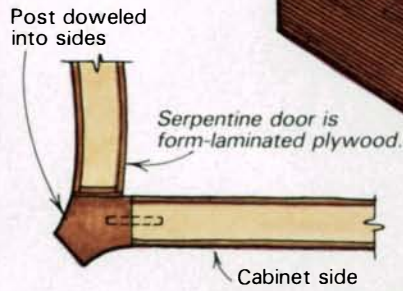

Fig. 2: Cabinet detail

Veneer and corner posts were sawn from same mahogany planks



Sean Sprague



Paul Harrell's serpentine-front cabinet illustrates several possibilities of sawn veneer. The cabinet's solid corner posts were sawn from the same plank that produced the veneer for the sides and doors. The doors themselves are laid up over form-laminated plywood edge-banded with veneer from the same plank.



# Malletsmithing

*Make your own quality croquet set*

by Michael Hanner

*Though you may not have the impeccably manicured lawn required for serious croquet, you can make a serious croquet set, like this one by Michael Hanner, with little more than a lathe. (The balls are made by C.P.J. Webber, Ltd., of Exeter, England.)*

Fifteen years ago, I drove into Eugene to pick up an old friend who was moving to Oregon from Los Angeles. His luggage consisted of two suitcases filled with games and a croquet set. Within a few weeks, I was hooked on croquet. The game we played was traditional backyard croquet: nine coat-hanger wickets; undersized mallets, often with plastic faces; two broomsticks as stakes and rules that changed by the minute.

As little as ten years ago, I probably could have saved myself from addiction, but I embraced it. Soon we had replaced the wire wickets with ones of bent steel rod. This was getting serious. I tried making larger mallets using pool cues as handles. Bad job, so I bought a lathe and began exploring. Concurrently, I heard of the United States Croquet Association and an advanced form of the game they played, typically described as a combination of chess, billiards and war. A warn phrase, but true.

In the advanced game, it is important to be able to place the balls you control precisely where you want them on the court. For, unlike backyard croquet, you don't send an opponent's ball into the shrubs, but to a place on the court where that ball will be most advantageous to your scoring many hoops during a single turn. Ideally, the game is played as if one were crossing a shallow stream wearing new shoes. You don't want to get the

shoes wet, but you can find only three stones on shore to build a bridge with. So, to cross the stream, you must always pick up the stone (ball) you have just used and place it out in front of you once more. A movable bridge. But if you misplace one, your opponent will steal the other two, and leave you standing alone in the middle of the creek on a stone. And they usually laugh at that point. Yes, it's a foul, fiendish and decidedly nasty game.

The first time you stand on a full-size USCA court and know you have to roll two balls 135 ft. diagonally across court to attack your opponent or else he's going to score ten hoops on you, you realize better equipment is important.

**The components of a good advanced croquet set** are six wickets, made of  $\frac{5}{8}$ -in.-dia. iron or steel; a  $1\frac{1}{2}$ -in.-dia. stake; four 1-lb. balls,  $3\frac{3}{8}$ -in. in diameter; four mallets and a variety of accessories. Of these elements, the mallet is the most intriguing design and construction problem, but also one which allows the most freedom in design, as the specifications are brief, and personal preferences rampant. Typically, a mallet weighs  $2\frac{3}{4}$  lb. to  $3\frac{1}{2}$  lb. The head, usually of a dense wood, may be square, round or one of several other configurations. The striking faces must be parallel and are traditionally bound in brass. The shafts are usually 36 in.



Brass pipe is ideal for binding round mallet heads (top). Make sure the rabbet is a snug fit; secure the binding with two or three countersunk brass screws. Below, Hanner turns the knuckle on a handle shank. The finished handle behind the lathe is a reminder of the desired profile.

long, bound in leather, bicycle grip, cloth or twine and constructed from ash, yew, hickory or birch.

When building a mallet, I begin with the head. The selection of the wood is critical, as it will affect the overall weight of the mallet and its balance. The most common wood for mallet heads is lignum vitae, for its high density and resistance to impact damage. I also use several species of rosewood, ebony and hard maple.

Most first-quality mallets are square or rectangular in cross section. There are many opinions as to why this is such a popular shape. My view is that a flat-bottomed mallet may be left standing on the lawn while the player heads for the bar. When he or she returns clutching a double martini, no stopping is necessary to retrieve the mallet.

A typical square mallet head is 2½ in. by 2¼ in. by 9 in. long. I bandsaw the block 2½ in. square and cut it to length, then joint it to the final size. Next, using a router or tablesaw, I rabbet each end for the brass binding. Mallets need not be bound, but binding helps prevent splitting. The brass shouldn't be flush with the striking face—I usually hold it back ⅜ in. I most often bind with ¼-in.-wide by ⅛-in.-thick flat brass, attached with flathead brass screws, countersunk flush with the surface. You can bend it around the head without too much trouble. Starting on the center-

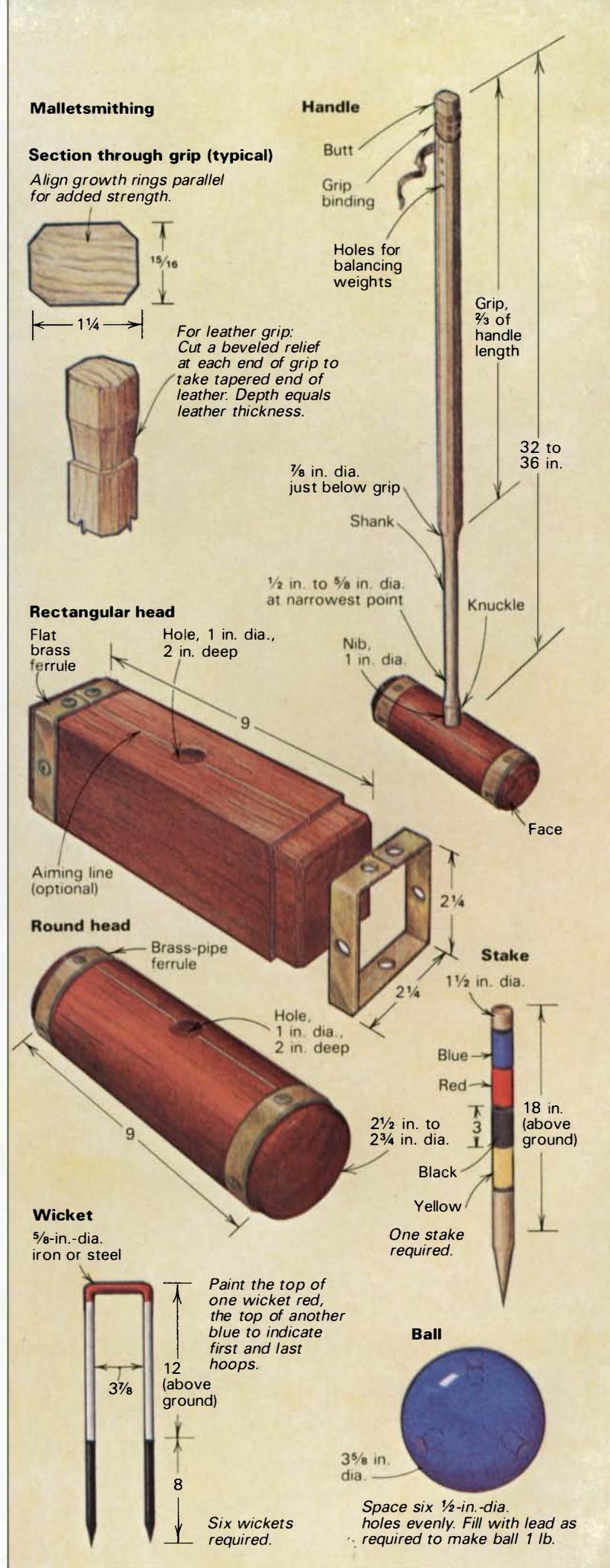

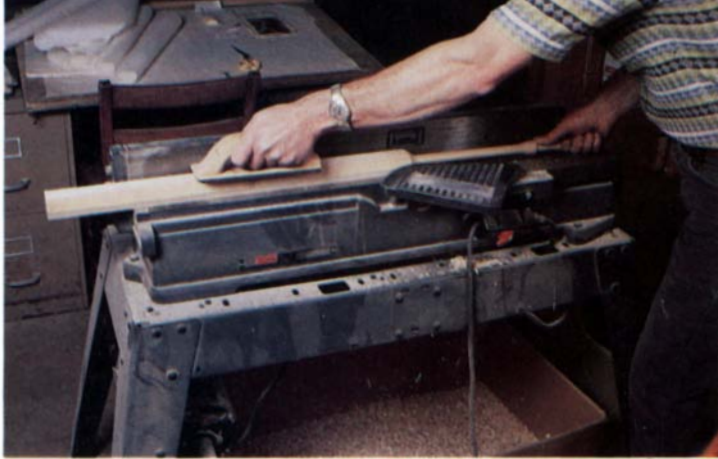

*Joint the grip carefully, making sure to maintain symmetry around the turned shank.*

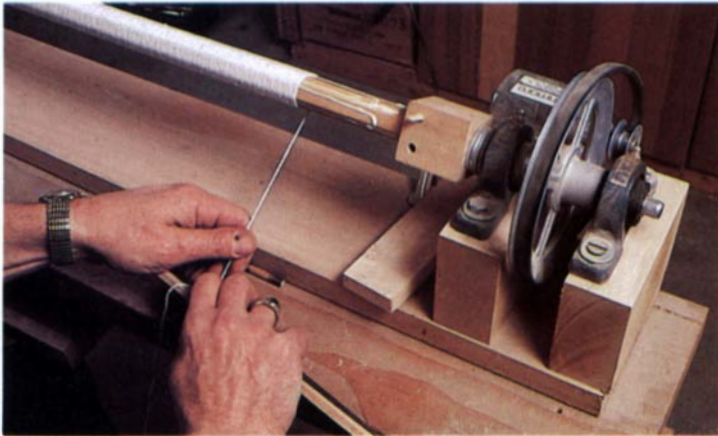

*Hanner binds a grip with twine on his homemade binding machine. An octagonal wooden chuck holds the butt of the handle and a cradle holds the shank. The device is powered with a sewing machine motor and a variable-speed foot control.*



*Almost-round croquet balls are relatively easy to turn. Accurate templates are a considerable help in turning truly round balls.*

line of the top, mark and drill a pilot hole, then set the first screw. Clamp that section of the brass in place on top so it will maintain a tight corner when bent and make a 90° bend in the brass. Set the second screw and continue around to a butt joint on top, filing the ends to fit tightly.

I finish the head on a belt sander, working from 80 grit to 240 grit and easing the edges of the wood to match the curved brass corners. Last, I sand a 45° bevel on the edges of the face wide enough to include the front edge of the brass as well. Sand the striking faces flat and at right angles to the sides.

Some people prefer a mallet with an aiming line that runs the length of the top surface on the centerline. Before binding the head, you can make a thin saw cut on the centerline and inlay a strip of contrasting wood or paint. You can also laminate the head, sandwiching a thin piece of contrasting wood between two halves. After drilling the 1-in.-dia. by 2-in.-deep shaft hole, I finish the head with light coats of polyurethane varnish.

**Round mallet heads are turned** from octagonal blanks 10 in. long, which includes ½ in. allowance for waste at each end. When I'm within ⅙ in. of the final diameter, I rabbet each end to receive a brass binding, or ferrule. The thickness of the brass pipe or flat brass bar that I use for ferrules dictates the depth of the rabbets. Using pipe eliminates the butt joint, but requires very accurate turning to achieve a tight fit. (Thick-walled brass pipe is available from plumbing supply houses.) After rabbeting, take the mallet head off the lathe and set the ferrules. (Key a blade on the drive center to its depression on the work so the piece can be remounted later in exactly the same position.) I predrill and countersink for brass screws.

After installing the ferrules, remount the head on the lathe for final sizing and finish sanding. (You can cut a groove for an in-laid aiming line, or sandwich woods together as described previously.) I bore the 1-in.-dia. hole for the handle 2 in. deep using a cradle to hold the head in position on the drill press.

**Mallet shafts are usually** 36 in. long with the lower third turned and the upper two thirds (the grip) hexagonal. I've had a 30-in. tool rest made for my lathe so I can turn the full length of the shaft, as well as croquet stakes, without resetting the rest.

When I began building mallets, I made a profile template for the shank, but have abandoned it as my eye improved. I still use templates (maple scrap notched to the correct radii) to check the diameters, because certain diameters give good playing characteristics. Obviously, the thinner the shank, the more action or whip it will have, but the more likely it will break. In general, the minimum shank diameter should be ½ in. to ⅝ in.

I begin with 1½-in.-square by 38-in.-long blanks, usually hick-

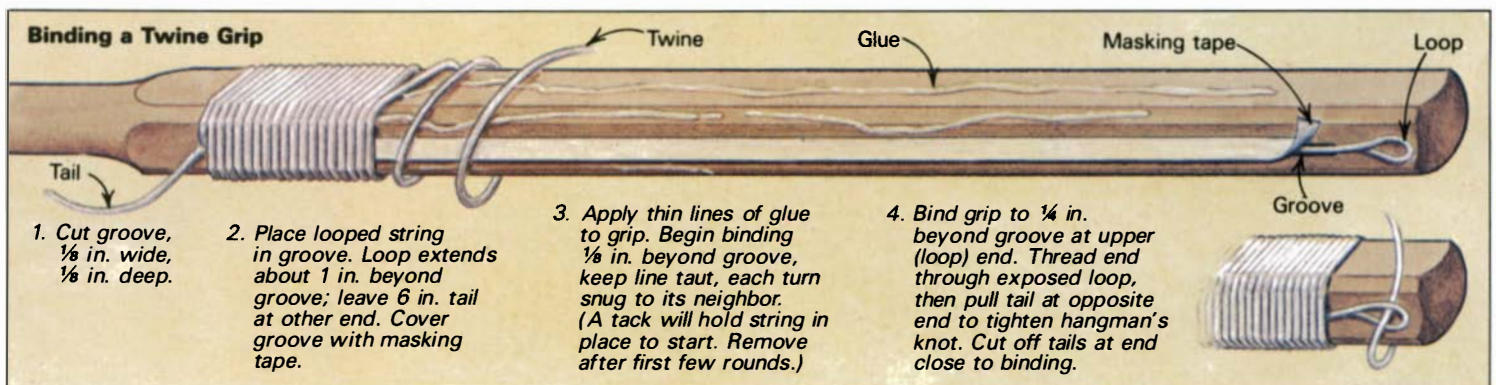



ory. Make sure to use straight-grained pieces—if not, the handle will be more likely to break. Long, thin pieces often require some sort of intermediate support, such as your hand or a steady rest. The profile I prefer starts with a 1-in.-dia. nib, which fits into the hole in the mallet head. Next comes the knuckle, which tapers sharply to  $\frac{5}{8}$  in., the narrowest point on the shaft, before tapering gradually up to  $\frac{7}{8}$  in. just below the grip.

After turning the shank, true and finely shape the grip on the jointer to the finished cross-section shown in the drawing. The dimensions are my personal preference and can be varied to suit. Note that the growth rings are parallel to or perpendicular to the direction of the force of a swing, which I've found gives the mallet a more accurate follow-through. Holding the nib of the shaft and pushing with a push stick, as shown in the top photo, facing page, make a few shallow passes on one face to establish a flat base surface. Make sure the fence of the jointer is at 90°, then true three more surfaces, rotating the blank 90° after each. Next, make these four surfaces bilaterally symmetrical about the turned shank, and reduce the cross section to the desired dimensions. Then set the jointer fence at 45° and plane the chamfers  $\frac{1}{4}$  in. wide. During the shaping operations, take care to maintain the symmetry and concentricity of the shaft.

Cut off the tailstock scar and sand the end of the grip to a gentle curve. If you're binding with twine, rout a groove in one of the narrow faces, about  $\frac{1}{8}$  in. deep and within 1 in. of each end of the grip. The groove prevents binding of the cinchdown cord. For leather binding, cut a beveled relief around the grip 1 in. from each end, as shown in the drawing on p. 47, to allow the leather to finish flush with the grip. I make bandsaw cuts equal to the thickness of the leather around the grip, then chamfer into the cuts with a chisel or bandsaw. Apply the finish before binding the grip; I use polyurethane varnish for the exposed wood of the grip and a shellac sealer coat under the binding.

A well-made mallet must be balanced. Typically, the balance point is one-fifth of the shaft length from the head (that is, about 7 in. from the bottom of the mallet). I balance the mallet before binding the grip, slipping the head temporarily in place to do so. I balance it by drilling a  $\frac{1}{2}$ -in.-dia. hole axially into the butt of the handle and packing it with lead; or by packing a series of  $\frac{1}{2}$ -in. holes drilled through the upper portion of the handle just below where the binding begins. These holes are then plugged with wood. (One-ounce lead fishing sinkers with their eyelets snipped off are fine weights.) The binding will affect balance, so I cut a strip of leather or twine of approximate length, roll it up and tape it to the center of the grip area while balancing.

I built a little lathe-like machine to bind handles with twine—with it, a handle takes only a couple of minutes to bind. You can easily bind by hand, too. I use ordinary 18-gauge cotton twine. Start at either end of the  $\frac{1}{8}$ -in. groove cut in the grip portion, leaving the first 6 in. of twine out of the groove, as shown in the drawing. Run the twine up to the other end of the groove and back, forming a loop that extends about 1 in. beyond the groove at the other end. Cover the string-filled groove with masking or drafting tape, and apply thin lines of white glue up and down the surfaces of the grip. (Though white glue is water soluble, it makes removal easier for periodic rebinding.) Starting about  $\frac{1}{8}$ -in. beyond the end of the groove, begin winding on the twine. Keep the line taut, each succeeding turn snug to its neighbor.

Bind the entire grip to about  $\frac{1}{4}$  in. beyond the loop end of the groove. Then cut the cord with 6 in. to spare, insert this end through the loop and pull on the tail at the other end of the groove. (This whole process is rather like a hangman's knot.)

Once the loop has been drawn down into the groove, cut off the tails at each end as close to the binding as possible. The cotton I use needs no finish, but may be sprayed with a stain repellent or periodically rubbed with gymnastic chalk.

For leather binding, determine the amount of leather you'll need (circumference times length plus waste). The width of the binding is a matter of choice, I prefer 1 in. to 1½ in. widths. Cut the leading end of the leather strip on a bias. The pitch of the winding determines the angle of the bias, so experiment before cutting. Epoxy the leading edge into the beveled relief, clamping it briefly. After the epoxy cures, run lines of glue over the grip surfaces and wrap the handle, butting the joints. Apply epoxy to the second end and cut it off with a very sharp knife to fit the beveled relief at the top end. I haven't yet found a good solution for treating the ends of the binding, but a  $\frac{1}{4}$ -in. strip of electrician's tape or colored plastic tape works.

**Traditionally, the shaft nib** extends through the mallet head and is wedged in place. Although I through-wedge new shafts on existing heads (brass wedges work best), it leaves the end grain of the shaft exposed. A croquet mallet often leads a hard life. Once the finish has been breached by a couple of errant hammer shots too close to a hoop, moisture and discoloration follow. Therefore, I prefer a blind hole, attaching woods that do not accept glue readily (*lignum vitae* and its relatives) with a brass pin set through a hole bored perpendicular to the shaft across the widest portion of the mallet head. I epoxy glueable woods.

For years I've felt there are two great problems in popularizing advanced croquet: the lack of good lawns and good balls. When I began making equipment, I made my own balls, but found the task so tedious that I abandoned it and now purchase the balls that I supply with my sets.

If you want to turn your own balls, begin with a block of hard maple, 7 in. by 4 in. by 4 in. Cut lathe-centering diagonals on each end and bandsaw the blank to an octagonal cross section. Make three accurate semicircular templates, one the right size for a finished ball ( $3\frac{5}{8}$  in.), one  $\frac{1}{64}$  in. larger and one  $\frac{1}{64}$  in. smaller—to compensate for the finish. Rough-shape the ball, turning down the spindle ends until they're  $\frac{1}{2}$  in. in diameter (my templates are  $\frac{1}{4}$  in. less than a hemisphere to rest on these two "ears" when checking the size). It's easy to get a ball *almost* round. Round is a different matter. To check the final truing, I use the end of a piece of large-diameter pipe, milled perfectly flat. Placing the pipe against the ball will show up any high or low spots—a perfectly round ball will contact the pipe at all points. A hole cut in a flat piece of hardwood will work, too.

A regulation croquet ball weighs 1 lb. As no wood has the proper specific gravity to yield that weight at the prescribed diameter, you'll need to remove the work from the lathe and bore six  $\frac{1}{2}$ -in.-dia. holes, each 90° apart, and pack them with enough lead to bring the ball up to weight—this usually takes about 5 oz. Glue dowels in the holes, trim them off and finish sand.

I paint balls with a good grade of spray enamel, blue, red, black and yellow. I used to use an opaque primer before painting. However, after the balls have been through a few games (the attrition on paint being high) the primer shows. Clear primer at least shows off the wood when the finish is damaged. □

---

*Michael Hanner is an architect who makes croquet equipment for his company, A.F. Kopp Co., of Creswell, Ore. For more on croquet, write the United States Croquet Assoc., 502 Park Ave., New York, NY 10022.*

# Furnituremaking in Italy

## *Competition and cooperation*

by Josh Markel

Like many woodworkers, I was drawn to making wooden furniture out of a dissatisfaction with mass-produced goods. Much of what I've seen in the typical furniture showroom, though reasonably priced, seems so compromised in the name of mass appeal and efficient production that the hand of the designer has been long since obliterated, not to mention the hand of the craftsman who actually made the piece. The renewed interest in hand-crafted furniture has answered this dilemma in only a small way. Yes, today's designer-craftsmen produce exquisitely designed and superbly built furniture, but the large number of hand-to-mouth furnituremakers suggests that what they make is beyond most people's means.

Yet, there is quality wooden furniture to be had at prices that won't send you to the bank for a second mortgage. Furniture imported to the United States from Scandinavia, Germany, and particularly Italy, shows a tremendous design vitality that appears to have more in common with one-of-a-kind craft furniture than the latest offerings from High Point or Grand Rapids. In the fall of 1984, I went to Italy for a glimpse of how the Italian furniture industry works, and to look for some solutions to the discouraging economic outlook American designer-craftsmen face. My

prejudice was that American woodworkers would be better off if they built less gallery furniture and concentrated instead on small production runs and prototypes for industry. It was my hunch that the Italian furniture industry resembled this model and that the resultant vibrant marriage of craft and industry plays a big role in making Italian furniture design so innovative. What follows is a journal of my trip.

My first stop was the annual Milan International Furniture Fair, the place where the world comes to see what's new in furniture. The fair sprawls through a dozen huge exhibition halls, each filled with exhibitors showing the widest variety of furniture, lighting, and accessories imaginable. It is geared mainly to home furnishings made by Italian companies, but several hundred foreign firms show as well. Wandering around on my first day at the fair, I saw furniture featured in *Arbitare* and other glossy design magazines, but I was surprised at how much junk was being shown; badly rendered "traditional" furniture (too heavy, too dark, too ornate) and what might be called modern opulent—clunky geometric forms seen through a thick layer of colored lacquer.

Still, there was lots of good design in evidence. Some of it (though far from all) was being displayed in booths labeled "artigiani" or artisan-made. These firms employ ten or fewer people, and correspond roughly to a small U.S. furniture or cabinet shop. One of my first conversations was with a man representing an artisans' cooperative from the region of Emilia Romagna, southeast of Milan. He confirmed an impression I'd had before my trip: Italy's small woodworking shops not only compete with one another, but they cooperate as well. Formal cooperatives help market their members' work, sometimes with the assistance of the regional government. For instance, the Emilia Romagna region had financed an exhibition at an Arab trade fair in the hopes of developing that lucrative market. The regional government offers tax relief and excuses small firms from the requirement to hire union labor, support that makes it easier for artisan shops to compete in world markets.

Another booth I visited was a firm called Capuzzi Arredamenti. There I saw a home furnishings system in which colored elements had been combined with light, natural wood into playful forms. Clearly production furniture, but the thoughtful use of color and sensible construction gave it a definite one-of-a-kind flavor. One of the most appealing aspects of Capuzzi's furniture is that it uses the modular design approach that we generally associate with office furniture. The consumer can



*The annual Milan International Furniture Fair is to furniture what Paris is to fashion. Although it's dominated by Italian companies, hundreds of furniture manufacturers from all over the world show at the fair each September.*



*The lacquered secretary-desk by Capuzzi Arredamenti, shown at left, is a colorful example of the work produced by Italy's small furniture manufacturers. In design and execution it is not dissimilar from a U.S. designer-maker's one-off. A production run of 100 pieces will make it profitable for Capuzzi. Knock-down furniture, like the solid ash and veneer table by Luigi Crassevig, shown at right, is readily exportable. When snugged by barrel nuts, the bentwood rim compresses the table's leg tenons against the edge of the tabletop. Finished on both sides, the top can be reversed if damaged.*

pick various modules and combine them in ways to suit his or her own taste. What surprised me most about Capuzzi's furniture, though, was how it gets designed. I had imagined the designer drawing the piece and then trooping out into the shop to construct a prototype himself, or at least oversee the building. In fact, even small firms like Capuzzi (it employs 15 people) hire freelancers to design for them, leaving the shop free to concentrate on the actual woodworking.

The last booth I visited was that of Crassevig, a firm that specializes in bent wood. A Crassevig dining table seemed to typify the best of Italian design. It's a knockdown round table made up of only five pieces. A piece of solid ash 13 ft. long is bent into a circle whose ends don't quite meet. This piece forms a rim that is drawn tight around the table's veneered top by two barrel nuts. Each leg has a three-quarter-round tenon with a slightly concave shape milled into the other quarter. Inserted into mortises in the table rim, the legs are drawn tight when the barrel nuts are snugged. In a clever touch so typical of Italian design, the top is veneered on both sides, so, if worn or damaged, it can simply be flipped over.

Wanting to know more about who produced such sophisticated but disarmingly simple work, I approached a quiet gentleman in a short-sleeve shirt who spoke some English. He turned out to be Luigi Crassevig, owner of the company. Crassevig, who appeared to be about 45, explained that the firm had been in his family for 30 years, making mostly tables and chairs in a 15-man shop near Udine, northeast of Venice. Like Capuzzi, Crassevig employs outside design talent, in his case one designer with whom he shares a common philosophy. Crassevig explained that an idea for a new piece might originate with the designer or the manufacturer, but the designer usually works out the details and furnishes working drawings.

After two days of touring booths at the fair, I was anxious to get out in the countryside and visit some of the shops I had made arrangements to see before I left the U.S. My first stop was at Acimall, a trade organization representing the Italian woodworking machinery industry. Acimall had courteously arranged an itinerary for me and assigned a staff member to be my guide. We first visited the Balestrini Corporation, a machinery manufacturer located in Seveso, between Milan and Como. Balestrini actually grew out a family furniture business started during the 19th century. Balestrini, who had worked repairing some machinery for the family furniture business, began making specialized mortising and tenoning equipment,

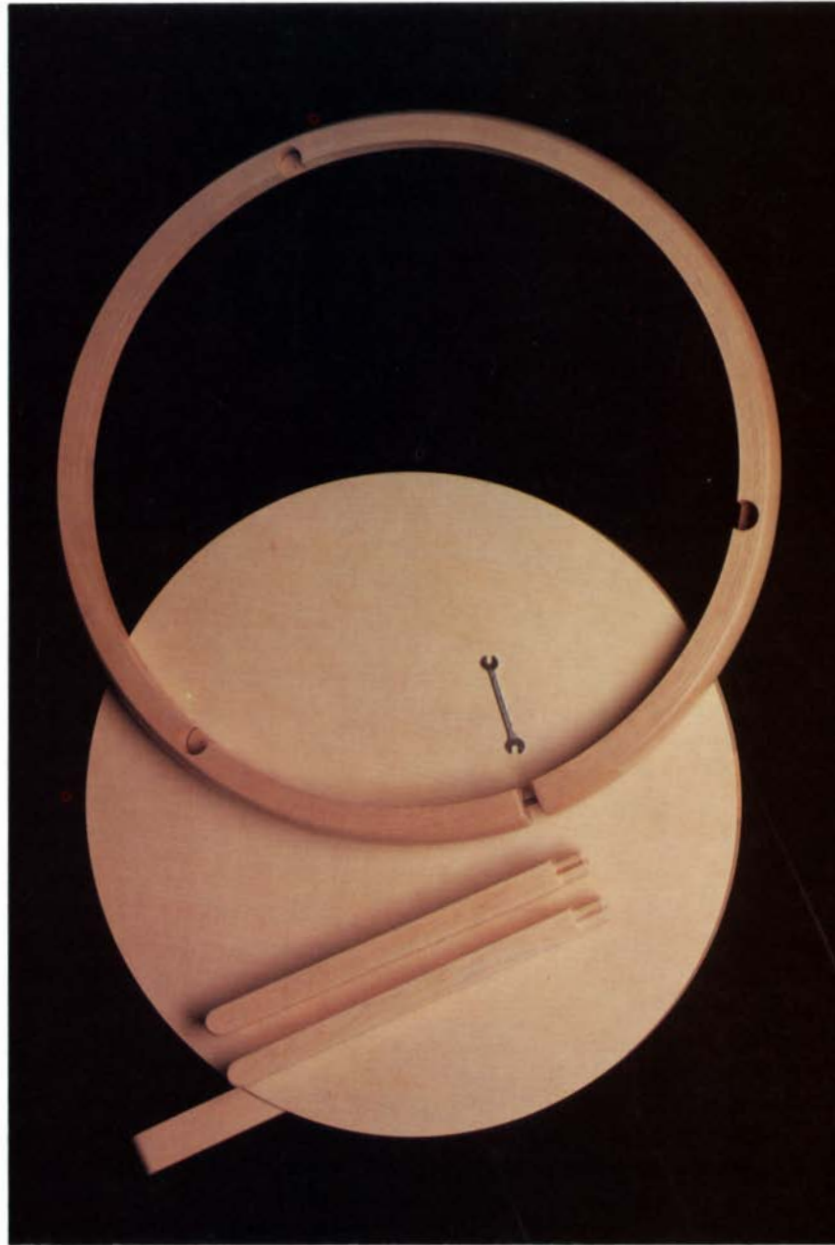

Courtesy of Luigi Crassevig

which he eventually sold to others. Today, the machinery company is far larger than the still-existing furniture shop.

Balestrini makes high-output woodworking machinery of the type commonly seen in Europe. This is sophisticated stuff: a tenoner, for example, uses a pneumatically controlled cutterhead to mill a tenon on the end of a rail in a matter of seconds. They also make multiple borers, molding machines and template shapers, some with computerized numerical control. Interestingly, much of Balestrini's equipment is exported.

After lunch, we went to visit the Balestrini furniture shop a few blocks away. In many ways, Balestrini furniture was exactly what I had expected to see in Italy. The firm consists of four people—two family members and two long-term employees. The factory and showroom are attached to the family house. The day I visited, the shop was jammed with machinery, stacked furniture parts and completed pieces. They make mostly chairs, and a lot of them, about 5,000 a year. I could see two reasons for this tremendous output. First, even though it's a tiny company, Balestrini has a very definite market for what it makes. Through contacts developed over the years, they get regular work from other furniture companies that can't eco-

nominally tool-up for a 200-chair order. Thus, they concern themselves with making, while someone else does the selling.

Second, Italians don't seem shy about investing in sophisticated machinery. In a shop about 30 ft. by 90 ft., I saw a versatile molding machine that shapes, sands and cuts to length, a tenoner, slot mortiser, planer, jointer, double-sided copy shaper, several sanding machines, a bandsaw, a clamping machine, and an overhead router. Some work is jobbed out—upholstery, finishing and bentwood parts, for example. But anyway you look at it, 5,000 chairs is a hell of a lot of production from four guys.

If the Balestrinis are the small-fry of the Italian furniture industry, Bernini, the next stop on my tour, occupies the middle ground. Bernini is well-known for its casegoods and high-style architectural millwork for commercial buildings. There I met Pepe Tanzi, a young designer who, like many of his peers, has design credentials that come from architectural training. Though he's familiar with woodworking technique, his time is spent at the drawing board instead of the bench. This way of work has some drawbacks. Tanzi said a chair designed by a craftsman in a shop like Balestrini might go directly into production, but a designer-originated piece might consume one or two frustrating years while a prototype shop works out the kinks and develops jigs. During this time, Tanzi explained, there will be much give and take between the designer and the craftsmen building the prototype.

While I was at Bernini, Tanzi showed me a dining table he had designed very much in the Modernist vein, a piece that elegantly expresses his view that the garish trendiness of the Memphis group represents a short-lived fad rather than a full-blown design

school. His table consists of a lacquered wood top mounted on two cylindrical pillars. The top is hinged lengthwise and fitted with sliding hardware so it can function as a drop-leaf dining table in a small apartment. Besides designing for Bernini, Tanzi is a partner with his brother and father in a furniture store that has been in the family since 1890. Throughout my trip, I found that these kinds of long-standing family connections often form the bedrock of a successful Italian furnituremaker.

Tanzi's partnership represents a loose vertical integration that keeps him abreast of what designers are designing and what people are buying. In some instances, however, the integration is even more direct. One such example is the firm of M.C., a family furniture business that takes its name from the initials of the owner, Marco Contini. He also runs Selvini, a high-style furniture outlet in Milan with one store selling to the public and another to architects and interior designers. Contini, whom I met at the fair, came into the furniture retailing business through his mother's side of the family. About 1967 he decided to produce some furniture of his own, so he commissioned Giovanni Offredi to design a few pieces. Eventually, Contini became a partner in the six-man shop outside Milan that built Offredi's designs. The shop also reproduces the furniture of Joseph Hoffman, a turn-of-the-century Viennese designer.

The Offredi pieces show the same design cleverness possessed by the Crassevig table. Their impact comes not from luxurious materials or flamboyant patterns or colors, but rather from function expressed in dramatically economical terms. Offredi's barstool, for example, consists of only three pieces; a curved pedestal, a fat dowel that acts as footrest, and a seat. This abstract composition works because the stool has a conservative lack of ornament, and it is an unashamedly industrial product exploiting techniques appropriate to wood.

So far in my travels, I had seen many successful shops, but none that in any way resembled an American craft-furniture maker. My next appointment came closest. Edoardo Dal Seno makes marquetry tabletops incorporating contemporary abstract geometric designs. Like my peers in the U.S., he shows his work in galleries and interior-design showrooms but, because very few galleries show crafts in Italy, he would like to have his designs picked up by a commercial maker for series production. When I visited, he was making only signed one-of-a-kinds, mostly on commission. He told me that the average price for one of his small coffee tables was \$1,200.

As a designer-maker, Dal Seno enjoys at least one advantage over his American counterparts—the profusion of small shops makes for a diversity of available services. Dal Seno has bases for his tables made by one shop, while another sprays the two-part catalyzed polyester finish. Farming-out complex work to a shop equipped to do it saves Dal Seno precious time and money he'd waste learning to do it himself. Still, Dal Seno struggles economically and, like many woodworkers in the U.S., he must supplement his income with other work. He designs for a large company that makes architectural glass products.

My last day in Italy was spent at a shop called Legnoimmagine. It was a nice transition to going home because it was almost like being home. Legnoimmagine is a two-person shop operated by Riccardo Chiozzi and Paola Balderacchi. I arrived on a cold, rainy day and the potbelly stove kept only parts of the shop warm, much as in my own shop. Riccardo and Paola were having lunch and they offered to share their spicy sausage, cheese, bread and wine with me. I soon learned that we had much in common.

Paola and Riccardo were the only people I had met who entire-



*Even small Italian shops are equipped with sophisticated, high-output machinery. Equipment like this makes it possible for four men in the Balestrini furniture shop, above, to build 5,000 chairs a year. Small shops get many of their designs from architects such as Pepe Tanzi, at left. Besides designing for Bernini, a large furniture concern for whom this black-lacquered table was created, Tanzi is also a partner in a retail furniture store.*



*The bent plywood barstools, above, were designed for M.C. by Giovanni Offredi, a freelance designer. M.C. is part owner of the shop that produces the chairs, which it sells in a Milan retail store. Edoardo Dal Seno's marquetry tables are produced as commissions. They sell for about \$1,200. He does the marquetry himself but other shops build and finish the table's base.*



ly build what they design. Both are college educated, self-taught woodworkers so in love with the craft that they are willing to put up with low pay while they attempt to develop profitable products. At first they made solid-wood furniture—desks, tables, and a chest with a simple dovetailed carcass—but lately they have changed their emphasis to prototypes for designers, advertising displays, and small objects like desk accessories and coat racks, which they can make themselves, in series production. They have also developed relationships with larger companies who sometimes call on them to produce a one-off. Like some of my contemporaries in this country, Paola and Riccardo have tried to sell their own designs to industry for mass production, but found they were always met with the same question: “Who sent you?” (Industry, it seems, is a tightly closed circle, even in Italy.)

I left Italy feeling that I had seen a good sampling of an imaginative, diversified, and vital furniture industry. But my premise that small shops produce the most creative work, and that the Italians had somehow succeeded as designer-craftsmen where Americans had not wasn't borne out. Indeed, I saw some of the same problems small-scale furniture makers here face: one-of-a-kind work is expensive to produce and meager sales bring little economic return to the maker. Moreover, many of the nice pieces I saw were made by very large companies. One modern casegoods plant I toured was so automated that few workers were evident. Instead, strategically placed robots fed sheets of particleboard to machines controlled by operators parked in front of glowing computer terminals.

Clearly, smallness of scale and interdependency play an important role in the quality of the attractive, contemporary Italian furniture I'd seen at the fair. But I couldn't put my finger on any one element that explains the vitality of Italian furniture design, at least not to the extent that I could immediately apply what I had learned to improve my own economics. The success of small shops like the Balestrinis' can be traced, I believe, to a host of



*Riccardo Chiozzi and Paola Balderacchi operate a two-person shop. Both are university graduates and self-taught woodworkers who hope to sell their designs to larger companies.*

factors, not the least of which is a long family history in the crafts. Italy's small-shop furniture tradition pre-dates the Industrial Revolution, and it thrives, in part, because Italian craftsmen have adapted to the whims of their market by making practical goods that people can afford to buy. With the help of sophisticated machinery, they keep expensive handwork to a minimum and turn out quantities sufficient to be profitable.

There are cultural considerations as well. Europeans in general, and Italians specifically, express a tremendous interest in the design of objects, from furniture to cars, to eyeglasses, to clothing. That's not necessarily to say that they have better taste, but a heightened awareness of how a thing is made makes one appreciate the difference between a shoddy knock-off and a well-designed production piece. □

*Josh Markel makes furniture and teaches woodworking in Philadelphia, Pa. All photos by the author, unless otherwise noted.*

# Shopbuilt Thickness Sander

*A low-cost alternative to handplaning*

by S.R. Cook

Having earned my living from one form of woodworking or another for the last 15 years, I feel qualified to talk about ways of making sawdust. I began as an apprentice pipe organ and harpsichord maker, moved on to furniture, folk instruments, and cabinets, and, during the lean times, turned to plain old nail swatting. My style of woodwork, whether for cabinets or furniture, leans heavily toward frame-and-panel construction, using  $\frac{1}{4}$ -in.-thick solid wood panels rather than plywood. In the old days, I cut mortise-and-tenon joints for frames and handplaned each panel to its final thickness. Three kids and no savings account later, however, I began doweling all my cabinet joints and traded my meditative stints with handplanes for ear plugs, dust mask and belt sander. As I spent more and more time hanging on to that digging-in, corner-dipping belt sander, I yearned for a better way to surface wood. This yearning became a necessity when I fell for a \$300 bargain and ended up with 1,500 bd. ft. of rough-sawn birch from a local mill. After doing a little research on surfacing machines, I concluded that a power-feed drum sander was what I needed. The price was a bit of a snag, so I decided to build my own sander. My design was inspired by the planers offered as kits and plans by Kuster Woodworkers, P.O. Box 34, Skillman, N.J. 08558 (see box). A machinist friend and I modified the original idea to suit my needs and budget, and produced the machine shown on the facing page. It can sand panels up to 24 in. wide, down to 180 grit. With 36-grit abrasive, I can quickly dress a whole batch of rough lumber to a consistent thickness, then switch to finer grits and bring the lot to a smooth finish—all at a cost of \$150 for parts and 50 hours assembly time.

My sander consists of three basic mechanical units: the sanding drum, the feed roller/speed reduction mechanism, and an extremely accurate table-height adjustment mechanism based on bicycle chains and sprockets. These parts are supported by a wooden box-like frame: the upper part of the box holds the drum and feed rollers, the lower helps support the table-height adjustment mechanism. Four sturdily braced legs attached to the box complete the machine.

The box must be strong and stable; I originally used 2-in. birch lumber, as shown, but later replaced this with  $5\frac{1}{2}$ -in. by 24-in. sides made of two sheets of  $\frac{3}{4}$ -in. Baltic birch plywood, laminated face to face. Lay out the sides carefully, making sure both sides are square and mirror images of each other. Inaccuracies now will mean alignment problems later. After cutting the box pieces to size, glue the hardwood crosspieces and vertical supports to the side pieces. Reinforce the rabbet joints with long sheetrock screws, but don't add the screws until you've installed all the hardware, to make sure that the screws won't interfere with any mountings.

For added rigidity, you might want to add a  $\frac{1}{4}$ -in. plywood bottom to the box. A 1-in.-square batten, glued and screwed to each end, accommodates the ends of the threaded adjustment rods.

When the box was completed, I added four legs long enough to raise the plywood sander table 34 in. off the floor. After using the sander, I decided it would be better to set the table at 30 in. to 32 in., about the height of my hands when they hang by my sides, to make it easier to lift the stock and feed it into the sander.

The table mechanism consists of four  $\frac{1}{2}$ -in. threaded rods, one in each corner of the frame, as shown in the drawing. I had a machinist turn both ends of each rod down to a straight  $\frac{5}{16}$ -in. shaft, so the end resembled the tenon and shoulder on a chair rung. The lower end of each rod sits in a  $\frac{5}{16}$ -in. hole drilled in the corner of the frame's 1-in. by 1-in. lip, as shown on the facing page, far right, and its shoulders bear on a large washer embedded in the lip. The washer prevents the rod from wearing through the wood. The top end of each rod fits in an upper angle-iron support screwed to the frame.

Between the upper and lower supports, each pair of rods is threaded through a 28-in.-long piece of  $1\frac{1}{4}$ -in. angle iron, which is, in turn, screwed to a  $1\frac{1}{2}$ -in.-thick laminated plywood table. The four sprockets bolted to the threaded rods are connected together with a taut length of roller chain (bicycle parts work well and are readily available). When you turn the adjustment wheel welded to the top of one of the front rods, all the threaded rods turn simultaneously, and the threading action raises or lowers the plywood table, giving you the ability to set the sander's depth of cut. I got my wheel from a scrapped tablesaw, but you could make one by brazing a metal handle to a steel disc.

To make the mechanism, bore a hole through the angle iron and weld a  $\frac{1}{2}$ -in. nut over the hole. Then, thread a sprocket welded to a nut, a free nut, and one end of the 28-in. angle iron onto each rod. The free nut is used to lock the sprocket to the threaded rod. Don't install the chain until after the drum is aligned.

I made the sanding drum from a 24-in. length of 6-in. steel pipe. A machinist cut a lip inside the pipe to accept  $5\frac{3}{4}$ -in.-dia. discs cut from  $\frac{1}{4}$ -in. steel plate, and welded them in. Next, I bored a  $\frac{3}{4}$ -in. hole through the center of each end and ran a 32-in. by  $\frac{3}{4}$ -in. shaft down the length of the drum through the end caps, offsetting the shaft so it's longer on the drive-pulley side. After welding the shaft to the end caps, we chucked the entire assembly in a metalworking lathe and turned it true. The drum will probably still be out of balance and spin roughly. To check the balance, I slid the ball bearings onto the shaft, set the drum in the sander frame and spun it several times. If the drum always stops with the same side down, you know it's out of balance and the down side is

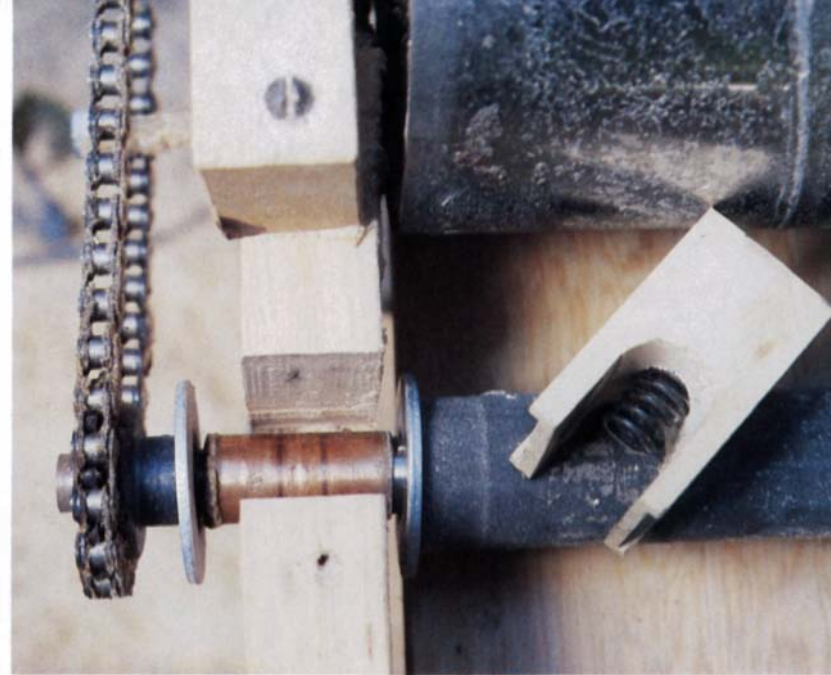

*Steve Cook's shop-built abrasive sander, left, can flatten and thickness 24-in.-wide panels with 36-grit paper, then, with progressively finer grits, bring the whole batch to a smooth finish. Cook built the unit using bicycle parts, pipe, wood and commercially available rollers for about \$150 and 50 hours assembly time. To mount the feed rollers, he slipped a copper pipe bushing over each shaft, added washers as shims to keep the roller from sliding back and forth, then secured the assembly with the spring-loaded wooden cap screws shown above. The sander table is adjusted by means of four threaded rods, right, running through nuts welded to an angle-iron frame. The bicycle chain connecting the sprockets on the rods makes it possible to raise or lower all four corners of the table simultaneously.*



the heavier side. I corrected the imbalance by drilling shallow  $\frac{1}{4}$ -in. holes straight into the heavy side. Remove a little metal each time, and don't go all the way through the drum wall. I made about 50 holes before the heavier side seemed to disappear and the drum began to spin smoothly. Also, have the machinist mill a 2-in. start groove through one end of the drum to anchor sandpaper strips.

Next, install the bearings and wooden pillow blocks to hold the drum. I used caged automotive ball bearings with an inside diameter that fit over the  $\frac{3}{4}$ -in. shaft and a 2-in. outside diameter to fit the pillow blocks. On the drive side, bearings with double ball rows were used to accommodate side thrust. Slide the bearings over the ends of the drum shaft and position the shaft's long end on the drive-belt side. Place the bearing and shaft in the V-notches cut in the frame sides, place the notched caps over the bearings and bolt them down tightly. The pressure of the V-blocks is the only thing holding the bearings in place. To prevent the drum from moving left to right, I shimmed the space between the end of the drum and the sander frame with several large washers. The pulley or sprocket on each end of the shaft outside the frame secures those ends.

After installing the drum, I used the threaded rods to align the table parallel with the drum. Adjust the front side of the sander first. Turn the threaded rods individually to bring the table close to the drum. Then, using a long piece of  $\frac{1}{16}$ -in. stock like a feeler gauge between the table and drum, twist one or both of the

threaded rods until the wood gauge fits snugly along the whole length of the drum. Lock the sprocket in place by tightening the free nut against it. Remove the wooden gauge without moving the threaded rods, and repeat the adjustment process for the back side of the sander. Your table and drum should now be perfectly aligned. To make sure you don't lose this accurate adjustment, install the bicycle chain as tightly as possible. There shouldn't be any play in the chain or between the sprockets. The lengths sold by hardware stores and bicycle shops come with two master links, which are a snap to use for joining lengths of chain together.

Since the feed rollers are the most expensive parts of the sander, I tried to come up with a way of making them in the shop, but I've found no substitute for the commercially available models featuring a steel shaft bonded with a thick cushion of rubber. I ended up investing \$76 for two rollers from Kuster Woodworkers. The rollers must be mounted keeping three things in mind: they turn at around 50 RPM, they have up and down movement of nearly  $\frac{1}{4}$  in. (they should hang  $\frac{1}{8}$  in. to  $\frac{3}{16}$  in. lower than the bottom of the drum for positive contact with the wood), and they must be fitted with stiff 1-in.-long,  $\frac{1}{2}$ -in.-dia. coil springs to keep steady pressure on the wood being sanded. Each spring in the bushing blocks should exert about 20 lb. to 25 lb. of pressure. I used a short length of copper tubing as a bushing on either end of the roller, as shown above. The spring bears against the tube, which slides in the vertical  $\frac{1}{2}$ -in.-square notches cut in the frame sides. Pack each

# Thickness sander

## Table adjustment

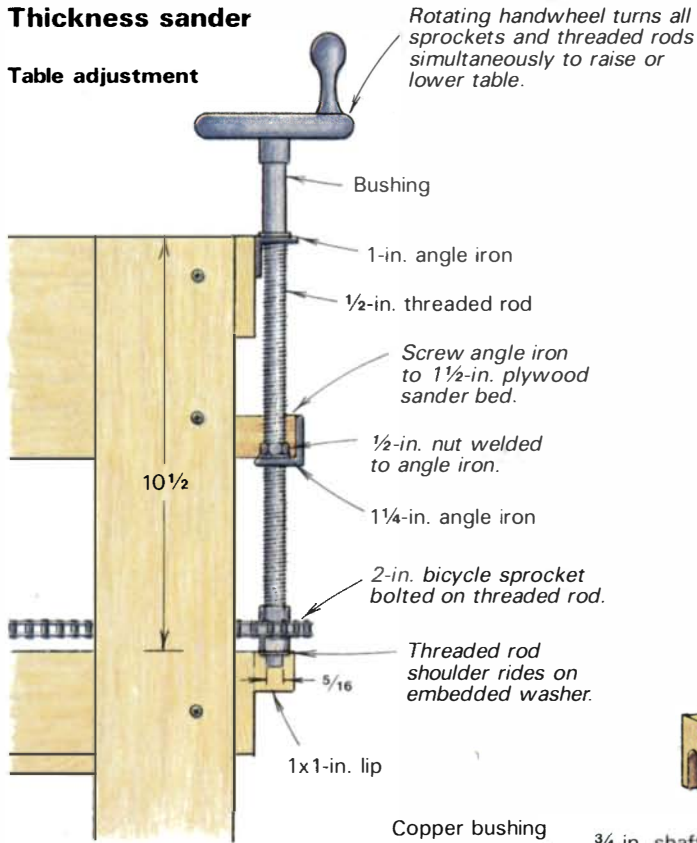

## Bushing block

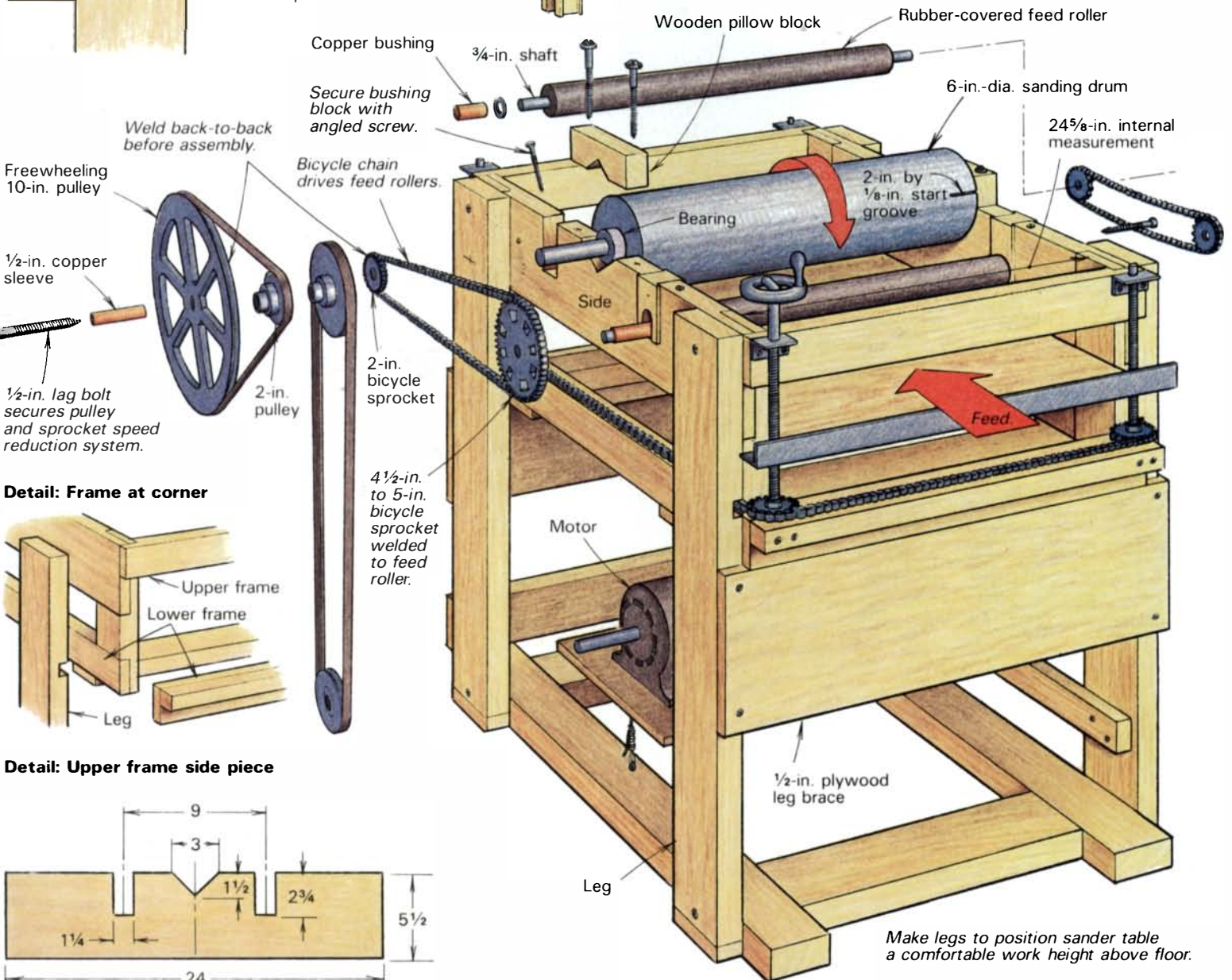
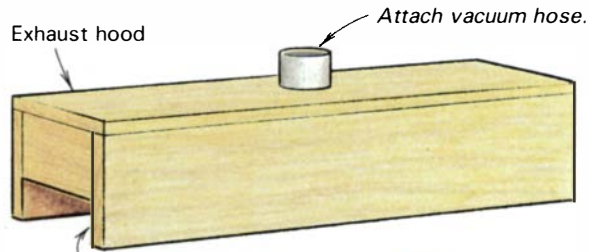
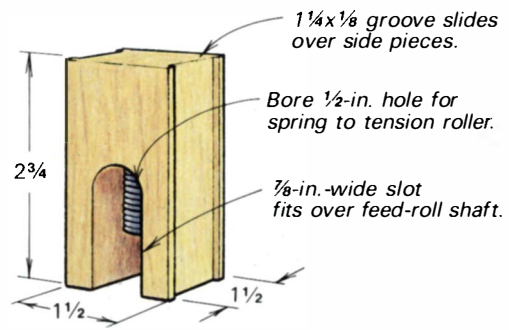

## Detail: Frame at corner

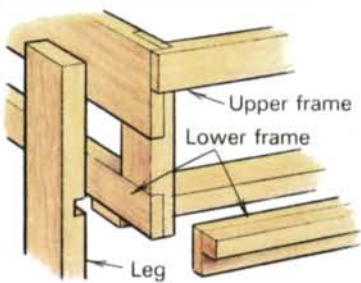

## Detail: Upper frame side piece

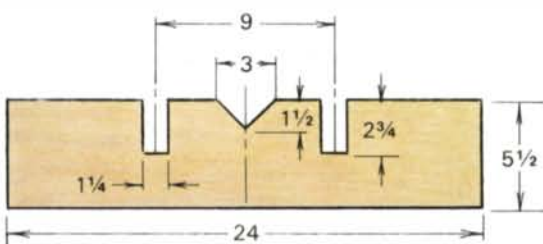

Make legs to position sander table a comfortable work height above floor.



copper tube with grease before inserting the feed roller.

To drive the drum at about 1,200 RPM, I mounted a 3-in. pulley on the shaft of my 1,725-RPM, 1-HP electric motor. The drum rotates clockwise, in the same direction you're feeding in the wood, so dust builds up on the outfeed side and is carried away. My feed-roller drive consists of a 2-in. pulley on the drum shaft, driving a freewheeling 10-in. pulley and a 2-in. bike sprocket screwed into the frame. I welded the 10-in. pulley and 2-in. sprocket together and bored the unit to accept a piece of ½-in. copper pipe as a bushing, greased the inside, and mounted the unit to the frame with a ½-in.-thick lag bolt. You need that heavy lag bolt because it has to handle a great deal of torque here, due to the difference in diameters of the two pulleys. The freewheeling sprocket, in turn, drives via a bike chain, a 4½-in. or 5-in. sprocket welded on the end of the infeed roller. This arrangement produces a feed rate of 21 ft. per minute. On the other side of the machine, weld a 2-in. sprocket on each feed roller and connect them with a taut length of bike chain. This drives the rollers together. I line up the pulleys and sprockets by eye, sliding them on the shafts until they are aligned, then tighten the set screws or tack weld them in place.

I buy 3-in.-wide rolls of open-coat aluminum oxide paper that are 75-ft. or 150-ft. long (available from Kuster Woodworkers). Wider belts work too, but they're harder to put on. It takes about 12 ft. of 3-in. paper for the 24-in. drum, but for narrow stock it's not necessary to paper the entire drum. The best way I've found to attach the strips is to spray the drum with a light film of Weldwood Spray Glue adhesive available from local hardware stores, then immediately apply the sandpaper. I tape the end of the paper to fit the start groove, secure the end with a wooden shim, and wrap the paper on in a spiral fashion, as shown above right, in the direction opposite to the direction of drum rotation. Grit changes can be done in less than five minutes, and the paper stays put.

To operate the sander, put a rough board on the sander table and crank it up until the drum starts cutting. The maximum depth of cut with 36-grit paper is ½ in. If the feed jams during a cut, crank the table down and take a lighter cut. I use 36-grit for roughing stock to thickness, then progress to 80, 120, and finally, 180 grit. As each board comes out of the sander, whack it to remove some of the sawdust and continue planing. Keep the paper

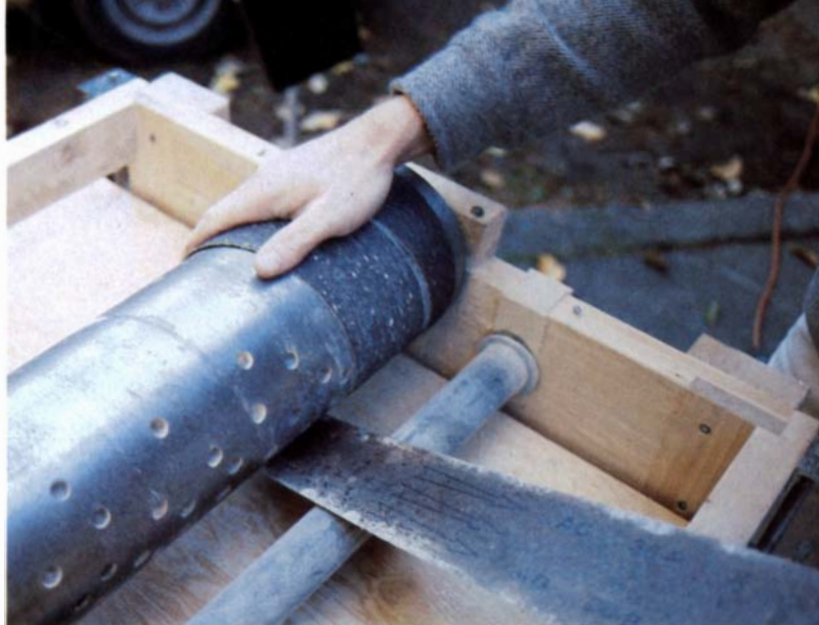

*To change sandpaper, Cook sprays adhesive on the sanding drum (note the holes drilled to balance the drum), then wraps on the abrasive. The paper spiral runs in the direction opposite to the drum rotation.*

clean with a rubber sanding-belt cleaner. On the last pass, run each board through the sander twice without changing the depth setting. This will compensate for any table flexing and ensure that the stock is accurately flattened.

Except for the sandpaper changes, the sander doesn't require much maintenance. Keep the bushings greased. You might want to drill and tap the ends of the feed rollers and lag bolt for grease fittings and bore holes through the diameter of the shafts for grease flow. Unless you do all your work outside, you should also build a hood to go over the drum, so the machine can be hooked up to your shop vacuum or dust collection system. Otherwise, you'll have problems preventing the sawdust from clogging the machine, and your shop. The simple hood I made is shown in the drawing. Building a guard over the feed drive mechanism would be a good idea, too. Feel free to use your own ingenuity to improve on, or change, my basic sander. □

*Steven R. Cook operates Pacific Rim Woodworking and Acoustic Keyboard Service in Edmonds, Wash.*

## **An abrasive solution**

by Curtis Erpelding

I'm a proponent of the hand-planed finish for one-of-a-kind pieces. Planing can be faster than sanding, and nothing can beat a hand-planed surface for clarity of figure and finish quality. But, for production work, handplanes can't always meet the demands of time and efficiency. I also hire assistants for production work, and it's not practical to teach part-time novice help to plane. For these reasons, I began investigating thickness sanders.

Thickness sanders looked more useful than belt sanders or stroke sanders. For my bent-laminated chairs, I need to surface ¼-in. face veneers before gluing them to core laminates in forms. Prefinishing these faces eliminates the tedious job of

sanding the curved surfaces after glueup. My other production work involves surfacing many dimensioned pieces, such as shelves, slats, box parts, and small panels. Belt sanding these parts wasn't faster than planing, and neither a belt sander nor a stroke sander was the solution for the veneer, even if I could handle the dust from a stroke sander. A thickness sander (I hoped) would handle the veneer, could quickly sand several pieces at once, and, with casters and port for a shop vacuum, fit efficiently into my work space.

I have friends who've had excellent results from simple hand-feed sanders, but I felt power feed was a must for production. Large abrasive-belt machines were

out of my price range and even the Ultra-sand, a ready-to-go drum sander manufactured by Kuster Woodworkers, P.O. Box 34, Skillman, N.J. 08558, was too large an investment for something I wasn't sure would work for me. After some deliberation, I chose the Kuster 24-in. Dynasand, a kit, which I thought I could adapt to suit my own needs.

I paid \$660 for my 24-in. model, which included all metal parts and hardware, the gear motor to drive the feed rollers, and plans for a wooden base. I bought the wood and a 2-HP motor to drive the drum. I could have scrounged the parts more cheaply myself, but I'm glad I bought the kit and avoided a frustrating hunt for parts

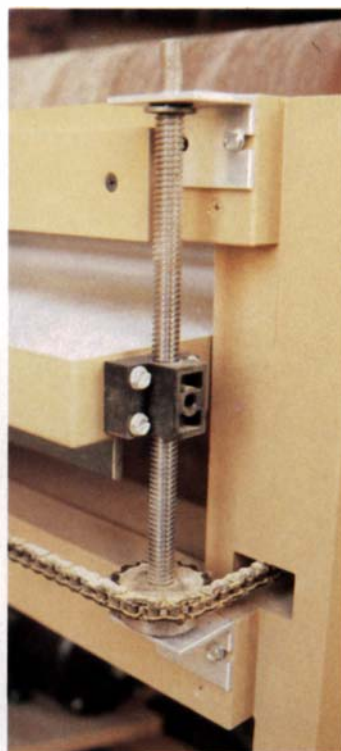

*Curtis Erpelding built his 24-in. power-feed abrasive sander from a \$660 kit, which he customized to handle the specialized needs of his production work. To eliminate sniping, he substituted angle-iron brackets for the machine's original aluminum brackets, which flexed enough to distort the critical alignment between the table, feed rollers and sanding drum.*

and hardware. I could have designed my own machine, but the trial-and-error involved would have cost me more in time than it was worth. I wanted a proven design and the simple and elegant Kuster machine met the test.

Construction offered no real problems, the plans were clear and well ordered. Although I would have preferred stronger mortises and tenons, I stuck to the half-lap joints in the plans, rather than risk altering dimensions and structure, and possibly creating assembly problems. The company had obviously invested a lot of time in working the bugs out of the design.

Some of the Kuster parts were crudely machined, though not to the detriment of function. The pillow-block bearings, however, were first rate, and the 6-in. aluminum drum was a thing of beauty, lightweight and true. I painted the frame with industrial floor enamel to give the machine a professional look and make it easier to clean. Electrical cord, plugs, switches and adapters ran about \$30.

The completed machine performed famously. It easily sanded out the knife marks, pits and ridges characteristic of thick-sliced veneer. It even sanded badly cupped veneer, the feed rollers gently flattening the wood and easing it past the sanding head. I did add a metal baffle on the outfeed side to keep the sprung-back veneer from hanging up on the frame.

It worked as well surfacing thicker

pieces, eliminating planer marks in one pass with 180 grit. But, it did create two problems which, luckily, were solvable. First, though it removed the planer marks, it left its own faint chatter marks. Secondly, it "sniped" the boards, leaving noticeable ridges on both ends of each board.

Chatter marks occur because even the slightest out-of-roundness or runout in the drum or bearings creates a definite washboard drum action. The slower the feed rate, the less noticeable the problem. Since the standard feed rate is already a snail-paced 12 ft. per minute, I needed another solution. By wrapping felt around the drum underneath the abrasive, I dampened out the marks almost entirely. For the finest work I then wet the grain, and, when dry, used a vibrating sander or hand block to remove any residual chatter and scratch marks.

The problem of snipe cannot be explained without noting one feature that surprised me—the feed rollers and the sanding drum rotate in the same direction, unlike a thickness planer, where the feed rollers and cutterhead rotate in opposite directions. After I tensioned the feed rollers as much as possible, thinking that necessary to hold the work, I found the machine sniped about 4 in. from each end of the board. The .007-in.-deep mark was quite visible. I called the factory and Bob Kuster (I found the folks at Kuster friendly and helpful) suggested I shim the bottom

of the feed rollers up to just  $\frac{1}{16}$  in. below the sanding drum and put only as much tension on them as necessary to feed the work. These prescriptions reduced the depth of snipe about .005 in., leaving just the faintest ridge at the points where the sanding head is when the front edge of the board hits the outfeed roller and when the back edge of the board leaves the infeed roller. With a dial indicator, I traced the problem to the lower brackets that support the threaded rods which, in turn, support the table. The rather thin aluminum brackets deflected .002 in. as a board was fed through. Replacing these with thicker steel angle solved the problem. The critical factor apparently is the difference in distance from the table between the feed rollers and the sanding drum. And, this is where I made another modification.

The absolute minimum depth of the feed rollers below the sanding drum is  $\frac{1}{16}$  in. Any less and the drum *will* catch the work and fling it through. Unfortunately, even something as simple as changing from 180-grit cloth to 36-grit cloth may reduce the distance beyond the minimum. For these adjustments, I put wood screws under the bushings that house the rollers. By turning these in or out I can lower or raise the rollers. Unfortunately it's hard to gauge the adjustment because the roller must be removed to get at the screws. A better solution would be machine screws through T-nuts mounted beneath the frame. This would be easy to install before the frame was assembled, but unfortunately, none of this is mentioned in the plans.

Even with proper tension and adjustment, the sanding drum can still catch and propel work out the outfeed side if you simultaneously feed in several pieces of different thicknesses. The feed rollers will center on the thicker pieces, allowing the drum to grab the thinner ones. The problem can also occur with uneven dust build-up on the outfeed roller. Multiple feeds must be the same thickness and the rollers must be kept clean. In any event, don't stand directly behind the machine when retrieving work coming through.

The hood I built for my sander accommodates my shop vacuum nozzle, but the vacuum catches only the fine airborne dust. The thick layer deposited on the board must be brushed off before sending the board through again, to prevent build-up on the rollers and resulting slippage.

I wanted a machine that would do surface sanding, sand more than one piece at once, be easy for a novice helper to operate, and fit into the scale and purpose of my shop. The Dynasand met or exceeded my expectations in every case. □

*Curtis Erpelding is a woodworker and designer in Seattle, Wash.*

# The Scraper

*A sharp burr makes shavings, not dust*

by Stephen Proctor

The term scraper brings to mind a tool for cleaning blistered paint from the sides of a house, or for chipping rust from the deck of a ship. It seems a poor term for such a fine tool, a tool capable of the finest of cuts and the heights of accuracy, an almost indispensable tool around a furniture shop. The term is something of a misnomer, for when sharpened to a burr edge, a scraper cuts rather than scrapes, much like a very low angle plane blade or chisel, slicing off paper-thin shavings of wood. As useful as the scraper is, it's surprising how few people understand how to sharpen and how to use it.

Scrapers come in various sizes and thicknesses and the methods I will describe for sharpening and use are the same for all. A standard scraper, good for most work, is a 2½-in. by 5-in. piece of steel, about ½ in. thick. Scraper hardness varies; I have had little luck using my methods on scrapers advertised as having hardened edges. For curved surfaces, a thin flexible steel that will conform to the curve is better. A gooseneck scraper (the whale-shaped one in the photo at right) contains a variety of curves that can be used on tight curves or moldings. I have four or five scrapers around so I don't have to stop and sharpen so frequently.

A rectangular scraper consists of four narrow edges and two broad faces. The cutting is done by a small burr formed at the juncture of a face and an edge (such a juncture is called an arris, as indicated in the drawing on the next page). The quality of the burr, and of the cut it makes, is entirely dependent on the quality of the intersecting surfaces. Two smooth, blemish-free surfaces produce a stronger burr with fewer of the microscopic serrations that produce a rough surface on the wood.

To sharpen the scraper, first dress the two long edges with a single-cut mill file. Clamp the scraper vertically in a vise and draw the file along the edge, trying to achieve a straight edge, perfectly square in cross section. All four arrises should feel sharp to the touch, if not, refile until they do.

Next, polish the faces of the scraper with a medium India stone followed by a fine, hard finishing stone—I use a hard black Arkansas stone. Be careful to keep the scraper flat on the stones, or you'll round the arris. Then, holding the scraper vertically between both hands, polish each long edge, rubbing the scraper to and fro along each stone in turn. Hold it diagonally across the stone to prevent uneven wear to the stone. Don't be tempted to polish on the edge of the stone, using the box holding the stone as a 90° guide—repeated polishings will wear a groove in the stone and round the edge of the scraper. After this operation, all four edges should again feel sharp to the touch.

A burnisher is required for the next step. It must be smooth



*A scraper, most often nothing more than a piece of thin steel, can be any of a variety of shapes. Common commercial scrapers are rectangular and gooseneck, shown in the center above.*



*After filing, work the faces and edges of the scraper on a medium and a hard stone. Hold the scraper diagonally across the stone's width to prevent wearing the stone unevenly.*



*To raise the burr, hold the burnisher at a slight angle to the face and stroke it firmly back and forth along the arris. To turn the burr, make a single firm pass along the arris, the burnisher held slightly less than perpendicular to the face.*

and of a harder steel than the scraper. If it isn't smooth, it will abrade the scraper and damage the burr. You can buy burnishers, but many things will work as well. My preference used to be the back of an old gouge. Currently I use a buffed-up pushrod from an automobile engine. Whatever you use, it may help to apply a little lubricant between burnisher and scraper. Oil is fine, or just rub the burnisher across your nose—it really does work.

Two steps are required to make a burr: raising the burr and turning it. To raise the burr, lay the scraper flat on the edge of a firm surface, hold the burnisher almost in the same plane (a few degrees off horizontal) and stroke it firmly back and forth along each arris. You should hear a loud tick as the burnisher goes off the end of the scraper at the end of each stroke. Hence the term ticketer, as the burnisher was once known. The resulting cross section is shown in the drawing and can easily be seen on the scraper with the aid of a magnifying glass.

There are many methods of turning the burr—the following one works well for me and is quicker than others I have tried. Holding the scraper vertically in the left hand, stick one of its corners into the bench, push it firmly into the surface to create a slight curve in the steel. Then, starting the burnisher near the top corner of the scraper and holding it at a fraction less than 90° to the face of the scraper, take one firm stroke down the arris, as shown above. Finish the small unburnished section at the top with a short upward stroke. Repeat this process on the other three arrises, making sure to turn the burr on the concave arris

### Scraper sharpening

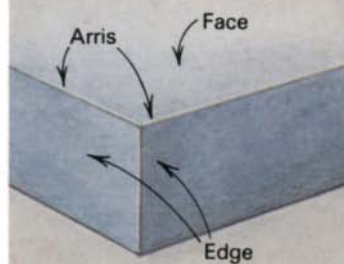

#### Step 1

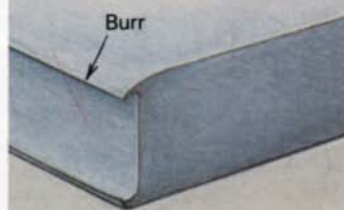

*Burnish almost parallel to the faces to begin the burr. (Size of burr exaggerated.)*

#### Step 2

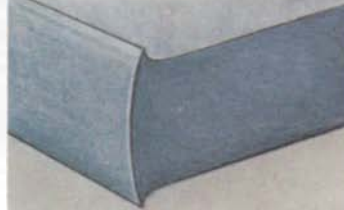

*Burnish almost perpendicular to the faces to turn the burr.*



*To scrape a flat surface (right), hold the scraper as nearly perpendicular to the work as possible and push or pull it to take wide shavings. A gooseneck scraper is ideal for tight curves (top). A flexed rectangular scraper can scrape shallow concave and convex surfaces (bottom).*

each time. It isn't necessary to curve the scraper to turn a burr, but I think that it puts a little tension in the burr once the curve is released, and this makes the burr a little stronger.

Taking several passes will turn a large burr, which will take a large shaving. However, a large burr takes longer to turn than a small one, and I've found them to be more brittle, possibly because of metal fatigue caused by the repeated passes made when turning the burr. In addition, a large burr has relatively little substance behind it to dissipate the heat generated during a cut, and this also tends to make it degrade rapidly. I prefer a small burr because it's less work in the long run. Gooseneck scrapers are sharpened by the same method, though the curves make the job a little more difficult.

**Scrapers are most commonly used** to remove a fair amount of wood from a flat surface. Why scrape, rather than plane or sand? A plane may tear interlocking or curly grain, but the scraper can manage nearly any awkward grain. The scraper face immediately behind the burr acts like a very finely set chip breaker, fracturing the severed wood fibers before they can tear out. A scraper also removes material quickly and leaves a finished surface, unlike coarse- or medium-grit abrasive paper, which removes the same amount of material, but leaves scratches.

To maintain the flatness of a large surface, like a tabletop, it is essential to cover as large an area as possible with one stroke of the scraper and to introduce as little curvature to the cutting



edge as possible. A curved scraper will make a concave cut—the greater the curvature, the greater the concavity. To avoid curvature, hold the scraper with your fingers behind the cutting edge and thumbs in front. Maintain a constant angle to the wood, as close to perpendicular as possible, and draw the scraper toward you, attempting to produce a shaving almost the full width of the scraper. Proceed across the surface with a series of long and slightly overlapping strokes. I prefer to pull the scraper, but you can push it, too, as shown above. It's easier to curve the tool when pushing, so be careful.

Unlike a plane, the scraper has no sole and may, therefore, ride up and down over hard and soft areas and create ridges on the surface. To avoid this, the scraper should be slightly diagonal to the direction of the wood grain. Alternate the diagonal orientation every other stroke, so that the edge will only take material from the high spots, leaving a flat surface.

For a fine, finishing cut, a small, sharp burr is needed; if the scraped surface isn't good enough, re-stone the scraper and turn another burr. Hold and move the scraper as described previously, keeping it as perpendicular to the surface as possible. Obstinate grain may require that the angles diagonal to the grain be increased to produce a skewed cut.

The third basic scraper technique is for shaping or truing concave or convex surfaces. Depending on the curves, use a flexible rectangular scraper or a gooseneck scraper, as shown on the facing page. By springing the scraper between fingers and thumb,

the cutting edge can be made to conform to a variety of curves. As the curve of the scraper tightens, the cutting angle of the scraper is inevitably lowered. As the scraper is lowered, the burnishing angle of the burr must also become more acute to maintain the proper cutting angle of the burr to the wood. You may need to experiment with various angles at first, but you'll get the feel of it with experience.

The most common fault when using a scraper is to concentrate all your energy on one small flaw—a slight tear or, most frequently, an edge joint in a veneered surface. The resulting surface looks as though it has been bombarded by billiard balls or has had a drainage ditch cut down it. To avoid this natural attraction to flaws, a good rule of thumb is to take two strokes either side of the flaw for every stroke on it. Also, try to cover as much ground as possible with each stroke.

As soon as the scraper no longer takes a shaving, it's time to resharpen. It is possible to re-turn a burr with the burnisher several times before having to go back to the file and the stones. Burnish the face first, then turn the burr at the desired angle. When the burr is ragged and leaves striations in the wood's surface, it's time to go back to the beginning of the process. Putting off sharpening because of laziness costs time and energy. The joy of using a sharp scraper is well worth the effort that it takes. □

---

*Stephen Proctor, a woodworker for 34 years, is Dean of Instruction for the Wendell Castle School.*



*The secret of these mysterious moldings eluded Irvin Rosen for 50 years until a shock absorber commercial showed him how to make a razor-sharp knife bob enough to cut undulating waves.*

# Ripple Molding

*Reinventing a 19th-century mechanical marvel*

by Carlyle Lynch

My friend Irvin Rosen was just a youngster in 1925 when he encountered a woodworking mystery that would haunt him for nearly 50 years. He was helping his father restore an 1830s-vintage clock embellished with a precisely cut ripple molding that he had never seen before. Rosen was impressed that neither his father nor his grandfather, both experienced craftsmen, could imagine how the molding had been made, though they were certain it had been cut with a machine, not handcarved. Rosen vowed to learn the secret of the mysterious molding. It took him nearly 50 years, and his quest led him to reinvent a woodworking machine that had been lost more than a century ago.

Rosen's machine is a motorized scraper. A lead screw connected to the motor drives a heavily weighted, razor-sharp cutter back and forth along a strip of mahogany or rosewood in a methodical carving/scraping motion. As the cutter assembly moves along the molding stock, a metal finger attached to it follows a special template to give the carriage a regular undulating motion that corresponds to the ripple pattern of the molding. It's a time-consuming process, taking several hundred passes to cut even a small piece of molding. Rosen suspects the original moldings were cut in a similar way, but he can't prove it. All the original ripple molding he's found has been on clocks made at the Jonathan Clark Brown factory in Bristol, Conn. Brown's factory burned in 1853, and his machine was destroyed. No patent, sketch, or description of it has ever been found.

I didn't meet Rosen until after he had invented his machine, so, on a recent visit to his home in the tiny hamlet of McKinley, Va., I asked him how he did it, with so little information to go on. Rosen is a slightly built, soft-spoken man loaded with what some call "native ability," that combination of sound knowledge of tools, a lot of common sense, and no fear of work. He needed

that kind of character. Before retiring as woodworking teacher at the Virginia School for the Deaf in Staunton, he spent much of his free time working on the molding—sketching, building, trying every idea he could conceive. But, after three years of almost constant thought and work following his retirement, he hadn't figured it out.

Then, after one especially tiring and discouraging day, he sat down after supper to watch the television news and saw a commercial advertising shock absorbers. A car was speeding over a series of railroad ties, its body moving smoothly forward, while its wheels danced a blurred staccato over the ties. There it was! Make the cutter dance up and down. He had already been experimenting with linear scrapers, so he began working to combine their back-and-forth motions with the shock absorber action. After experimenting with various types of tracks, templates and guides, he found the right combination.

The machine Rosen devised, shown on the facing page, center, is a fairly simple device. The motor drives a variable-speed pulley keyed to a long, horizontal lead screw mounted in pillow blocks. A nut on the shaft propels an angle-iron frame fastened to a carriage that straddles two angle-iron rails. The molding stock is clamped between the rails under the carriage, which, in turn, holds a vertically mounted cutter against the molding blank. A weight on the carriage forces the cutter against the strip while the turning shaft slowly propels the carriage forward, down the length of the shaft. As the cutter moves along the molding stock, a metal finger under the carriage bears against a rippled template fastened to one side of the track, causing the carriage to bob up-and-down (or left-to-right), as shown on the facing page. When the cutter reaches the end of the shaft, it flips a switch that reverses the motor, beginning the cycle in reverse. In this way, the machine can run unattended for hours. It takes about 200 passes, and



*Irv Rosen's machine-made ripple molding re-creates the original charm of antique steeple clocks made in Connecticut during the 1800s. Details, facing page, highlight the unerring precision and crisp cuts produced by his molding machine.*



*Ripple molding develops slowly from several hundred passes of a razor-sharp cutter, which is pulled back and forth over the molding stock until the desired depth of cut is reached. The rotating lead screw, foreground, first pushes the angle-iron carriage and the cutter down the length of the molding. A heavy weight on the cutter keeps it in contact with the wood during each pass. At the end of each pass, a switch reverses the motor and the rod pulls the carriage assembly back. The cutter, beveled on both sides, is shaped to match the molding profile being cut.*

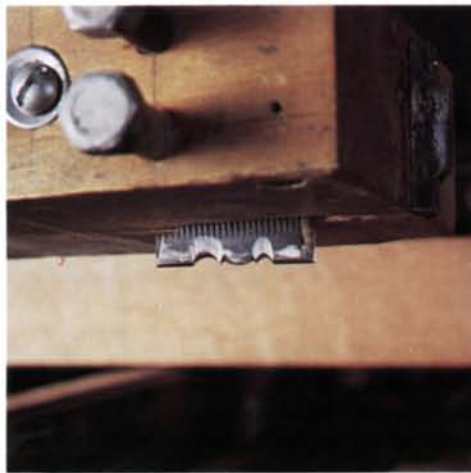

*To form a left-to-right waving pattern, the cutter assembly follows a ripple template attached to the side rails of the machine.*

# Handscraped waves

by Trevor Robinson

When my wife and I go to art museums, she claims I spend more time looking at the picture frames than at the pictures. That's an exaggeration, but I'll admit that I've long been fascinated with the ripple or wave patterns on some 17th-century wooden frames. I didn't have a clue about making the molding until I found a reference to a device called "a waving engine" in Moxon's *Mechanick Exercises*, first published in 1678. Moxon lived in Hol-

land during the period when those Dutch frames were made, so it's likely he learned about the technique there. By the middle of the next century, the waving engine was obsolete.

I patterned my waving engine after Moxon's, but had to make many modifications to turn his sketches into a working machine. The machine is basically a scraping device. The key to the undulating cut is a scalloped guide board, called a rack,

and a tapered guide bar mounted in a box-like frame under a cutter. You attach the molding stock (mahogany is my favorite) to the rack, then run the rack through the cutter frame. As the rippled lower face of the rack rides up and down on the guide bar, the molding stock is carried into, then away from the cutter, producing a wave-like scraping cut. The cutter is a  $\frac{3}{16}$  in. or thicker piece of steel with a 45° bevel behind its cutting edge. At the beginning of the cut, the guide bar edge is set level with the top of its slot and the cutter is clamped down so it's just touching the workpiece. Then the guide bar is raised slightly, and the rack pulled through and pushed back. After cutting the waves along the whole length of the stock, the guide bar is raised again, and the process repeated over and over until the molding has been cut to its finished depth. Each cut has to be very light. The depth of cut is controlled by a wing nut and threaded rod to advance the guide bar. The 21 to 1 taper on the guide bar means that as the bar moves into the frame, its top rounded edge rises slightly, but remains parallel to the engine base, ensuring a square cut. With a screw of 24 threads-per-inch, one full turn of the wing nut raises the molding 0.002 in., resulting in a cut of the same depth. Most of the time, raising the molding 0.004 in. gives satisfactory results, but initially you can cut twice that depth. The best finish cuts are obtained by making shallow 0.001-in. or even 0.0005-in. cuts. A simple calculation will show that if your molding is to be  $\frac{1}{4}$  in. deep, you will be pulling and pushing it through the cutterhead about 60 times. I think that's the reason the waving engine became obsolete! □

*Trevor Robinson, a professor of biochemistry at the University of Massachusetts in Amherst, makes musical instruments as a hobby and is intrigued by unusual ways of working wood.*

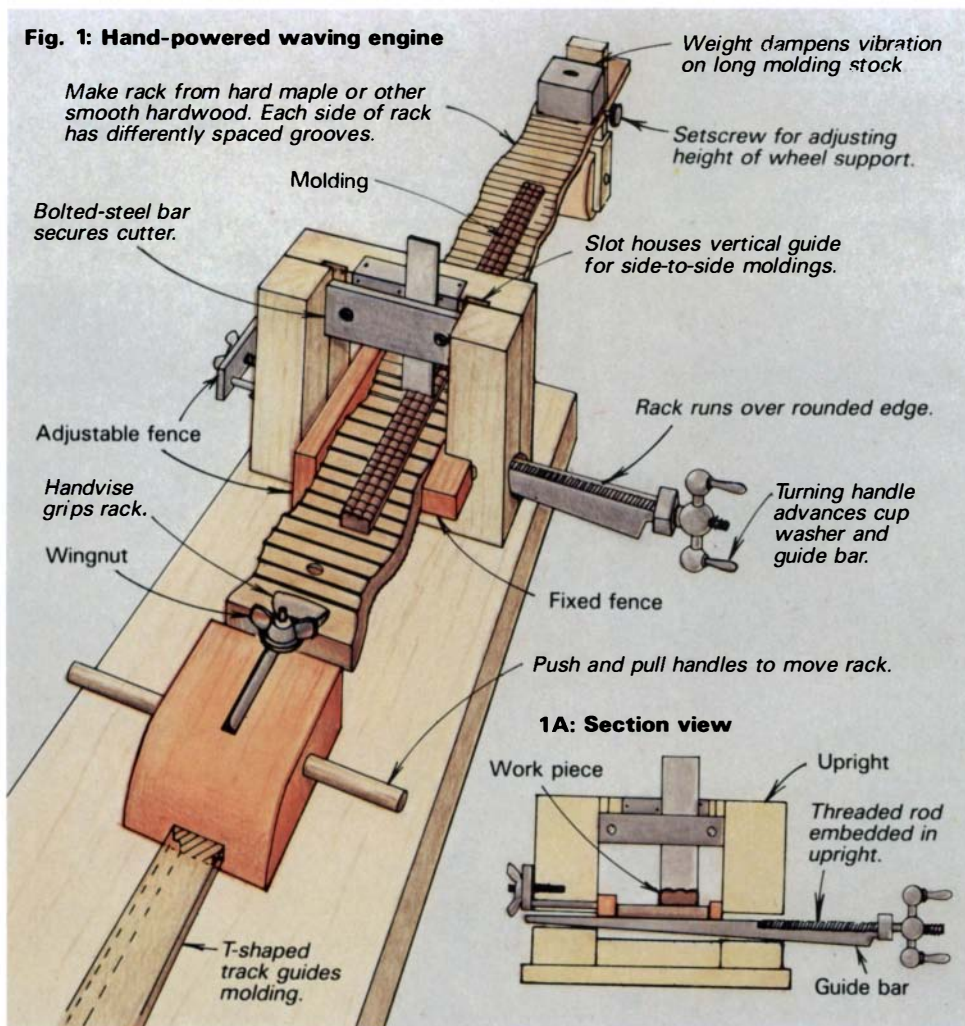

three hours, to mold a 25-in. strip of mahogany, and twice that long for rosewood. The variable-speed pulley lets Rosen control the speed of the cutter. The wider the molding and the harder the wood, the more slowly the cutter has to move.

Rosen has copied all the J.C. Brown moldings he's found. With another carriage, one that moves from side-to-side between the curved template and a strong spring, he makes "pie crust" molding, which resembles that on carved pie-crust tabletops. He has also discovered a way for his machine to make curved and circular moldings, but that part of his invention is still under wraps.

Rosen, himself an expert clock restorer and builder, now sells ripple moldings to craftsmen all over the world. Since that fire in 1853, steeple clocks, still a popular pattern of American shelf clocks, have been quite plain little things with little more than half-round pilasters decorating their cases. Now, thanks to Rosen's determination and curiosity, builders can give their reproductions all the compelling pizzazz of the Brown originals. □

*Carlyle Lynch, a designer, cabinetmaker and retired teacher, lives in Broadway, Va.*



# Chainsawn Seat

by Robert Erickson

Methods for shaping saddled chair seats, like those of Windsor chairs and old tractors, interest me. The traditional Windsor method, with adze, scorp, travisher and handplanes, seems satisfying but slow and not well suited to the small production shop. Jeremy Singley's kerf-bent method (*FWW* #50, pp. 30-36) is effective and novel but not, I suspect, much quicker. Sam Maloof's method of bandsawing narrow boards roughly to shape, then gluing them up as a seat blank seems better suited to the small production shop. Where possible, however, I like to use one or two wide planks for the seat; ripping them first would disturb the grain continuity. I've developed a method of shaping a tractor-style seat with a chainsaw and a body grinder that solves this problem and takes only about an hour per seat.

First, I bandsaw the blank to shape, then pencil-on the outline of the saddling on the top surface and the contour on the front edge. This contour curves down each side of the center arris to a maximum depth of  $\frac{1}{8}$  in., then gently up to meet the hard line of the arris defined by the outline on top. Next, I kerf the waste wood in the saddled area with the chainsaw. I've found I can control the saw better if I hold my elbow against my side. I work to within about  $\frac{1}{8}$  in. of the finished depth at this point.

To remove the waste and begin shaping, I work with the nose of the chainsaw at right angles to the saw kerfs, the bar at an acute angle to the surface, angled toward the seat center, as shown at right. Start at the seat back, about  $\frac{3}{4}$  in. from the pencil line, and slowly sweep the saw back and forth. After removing the waste, fine-tune the shape, working carefully back toward the outline and in to the center arris, letting the radius of the bar's nose define the curve of the saddle up to the hard lines of the arrises. The depth of cut is shallow, so there shouldn't be kick-



Joe Felzman Studio



*With a chainsaw and body grinder, Erickson can sculpt the tractor-seat saddle of his chairs in about an hour. After penciling the saddle outline on the top surface and the contour on the front edge, kerf the seat with a series of chainsaw cuts to approximate depth (left). Shape the seat by sweeping the nose of the chainsaw slowly from the arrises into the depressions. A body grinder refines the saddling and cleans up the chainsaw marks (right). The chair shown at top is made of California madrone.*

back problems. As with any chainsaw operation, however, be very careful.

To complete the shaping and clean up the chainsaw marks, I use a Bosch Model 0601 body grinder and 50-grit sandpaper mounted on a 4-in.-diameter flexible backing pad. My backing pad is a Rockwell #55746, and its  $\frac{1}{4}$ -in.-thick rubber is fairly stiff. I've tried grinding with a 6-in. disc and found it more difficult to control.

Sweep the grinder from the arrises into the seat's depressions. For better control, I choke up on the grinder's grip and press an elbow against my body while grinding. I finish-sand with a Makita pad sander with a 6-in.-diameter circular base, working from 60 grit up to 400 grit. □

*Bob Erickson makes chairs and furniture in Nevada City, Calif.*

# Guitar Maker's Inlay

*All the peghead's a stage*

by William (Grit) Laskin

I have been inlaying musical instruments for the decade and a half that I've been making them, but the mother-of-pearl diamond shapes that were my inlay initiation are a far cry from the designs that now keep me challenged. For the first few years, my inlays were of basic shapes: floral motifs, bird outlines, curling leafy vines or perhaps a person's name in script. Using .060-in.-thick flat pieces of mother-of-pearl or abalone shell, I would simply cut out the desired shape with my fret saw, file where necessary, epoxy the shape into a cavity routed with my Dremel mini-router, sand it flush when dry and, voila!, I had an inlay. That may sound over simplified but it's not; the essential procedures are indeed fairly simple.

As a guitar maker, my primary concern has always been the woodworking aspects and resulting sound qualities of the instruments. Like two-thirds of the instrument makers of the past century, I was content with inlays of outlined shapes. Such a style of embellishment did not tax my ability or time.

By 1975, however, I decided it was time to be taxed. I would take a lesson from the other inlay artists that preceded me and try my hand at engraving—the incising and coloring of lines on the inlay surface to create detail and shading. For, as I well knew, it was the engraving that brought the blank shell pieces nearer to a multi-dimensional realism. So, on the advice of no one in particular, I purchased a #1 “knife” shape graver and a small, round wooden handle at a local jewelers' supply. Once home, however, I got nervous. Did I have the correct type? How should it be held and used? My first hesitant scratches with the graver came out thin and uneven, making my inexperience painfully obvious.

Over the next couple of years, I set myself relatively simple engraving challenges that offered safe learning opportunities, such as adding detail to a flower's stem and leaves. If the graver happened to slip and cut a line

*A clown peeks around a corner and onto this peghead. His head and hands are mother-of-pearl, his collar abalone. A variety of woods complete his costume; the red on his face is engravers' wax.*

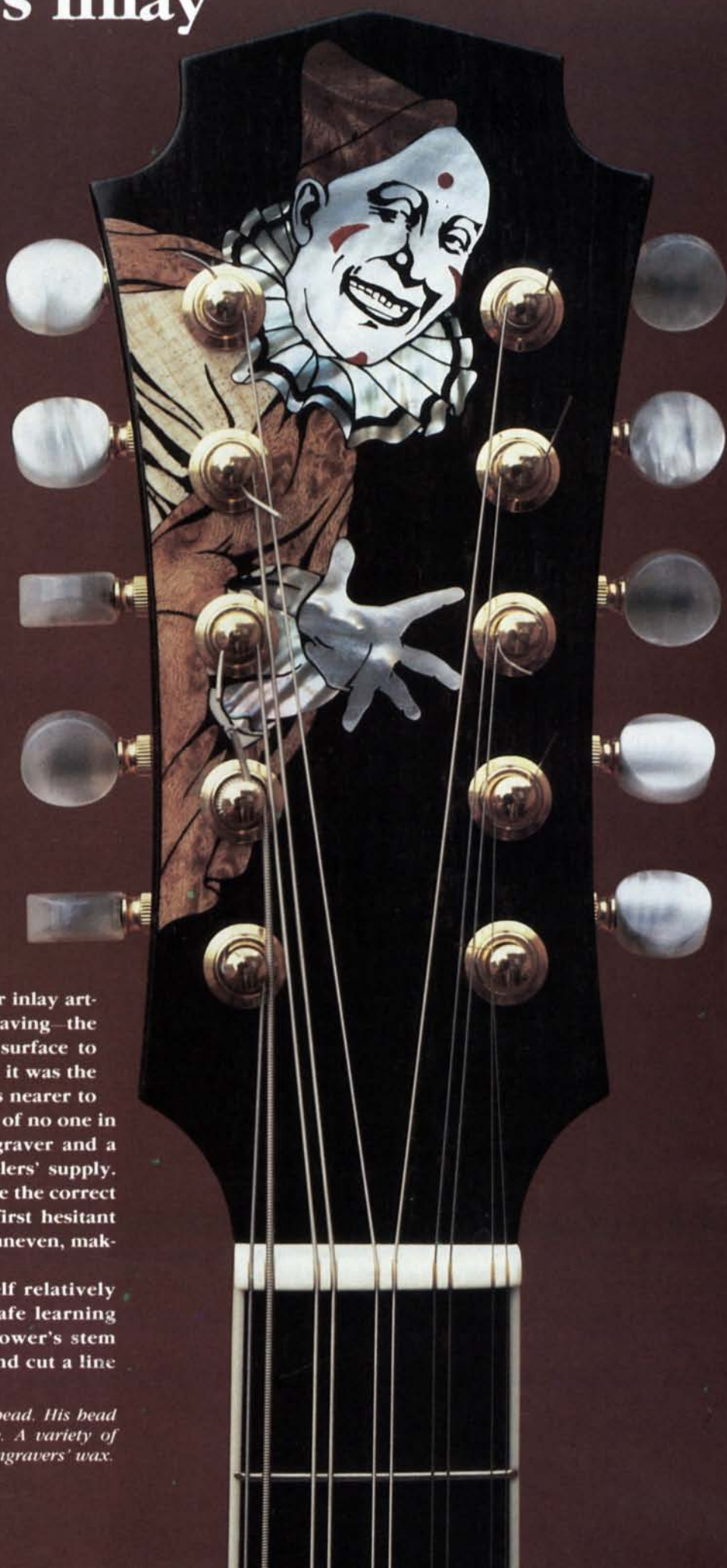

in an unintended direction, it was not an artistic hardship to incorporate an extra leaf vein into the design.

One day, while flipping through a book about engraving precious metals, I discovered that both the model of graver and the handgrip that I was by now quite accustomed to were almost completely wrong! Immediately, I rushed out and purchased the prescribed diamond-shaped graver, ground and shaped its edges as instructed, then gave it a test cut. I checked my grip, the angle of approach and my sharpening, and, in every instance, the new graver cut poorly and was harder to control than the old.

I concluded that for engraving mother-of-pearl and the like, I simply could not follow the same rules that apply to metal. I went back to my #1 knife graver and my own handgrip, and have not changed since. Even when I occasionally engrave precious metals, my graver technique, and a decade's practice at it, is enough to confidently guide even an inappropriate graver through metal.

**Until this point**, I'd been sketching inlay design ideas from any source immediately at hand: wine bottle labels, books on historic ornament, antique banjos, bird field guides, whatever. But now I made a conscious effort to be a little more adventurous. So, when a customer requested an old clipper ship to be inlaid on the peghead, instead of searching for a simplified motif, I wanted it to be as realistic as possible. I chose a ship in an old painting and, with a pantograph, enlarged it to sit neatly between the machine-head washers. Since the real ship's hull and mast were wooden, I decided to make mine from maple and mahogany, with mother-of-pearl sails and abalone flags. When it came to the myriad of hanging ropes, I cut in every line, rope, and rope ladder I could find space for. When I was done, my "clipper" looked more like a sail ship than any inlay of one I'd seen.

This, and similar inlays, signaled a shift in my approach to the whole process. Design ideas that I would earlier have rejected as impossible now appeared feasible. In a short time I began to enjoy creating small "scenes" on the peghead: Such things as a duck, wings extended, about to land in a marsh of reeds and bullrushes, or an 18th-century woman, shown from the shoulders up and surrounded by a garland of flowers. I engraved the woman's hair with a multi-line graver, which cuts a series of fine, closely spaced parallel lines in one pass.

About a year later, my design perspective altered once again. I was given free reign on a guitar peghead, and a side view drawing of a baker in traditional costume took my fancy. Unfortunately, if I reduced him to fit within the peghead's borders, his face would become too small to clearly engrave all the appealing details of his expression. After a few hours of agonizing, I decided to leave him the maximum size but have him appearing out of only one side of the peghead. I'd tell the customer that the baker was walking onto the peghead. The moment this rationalization occurred to me, a light snapped on in my head: "Of course! He really *is* walking onto the peghead. The movement is obvious and clearly suggested by his being only two-thirds in view. The inlay is more entertaining this way, as your mind imagines what it doesn't see."

I was very excited and pleased with myself just then. It didn't seem to matter that the baker's body overlapped three of the tuning machines and their washers, a hitherto taboo occurrence. I made certain that the baker's most important attributes—his face, hands and feet—were well clear of the machine heads and then simply located his torso where it seemed to sit best. The customer loved it, other instrument makers thought it was a great design and I was never more creatively satisfied by one of my inlays.

This was the beginning of my conception of the instrument's

peghead as "my little canvas" where I try to capture a live moment or convey movement by how much or how little of a scene, person, or object I choose to bring into view. There was now absolutely no subject I couldn't or wouldn't attempt. I never repeat a design, so I've had some wonderful challenges—various kinds of ships sailing onto the peghead, mermaids diving out of foamy seas, folk dancers in full ethnic costume, and so on.

I generally design an inlay from a composite of photographs and drawings. Life sketches, whether of my own body or someone else's, are a great help when trying to illustrate what an arm does when it's shifted like so, or what happens to a profile when the head faces more to the left. As my inlay approach has evolved, I lean more in the direction of early book illustration and drawing styles. For example, I now very consciously delineate all the parts of a design after it has been inlaid, engraving them to deepen their outlines, giving each an even, defined border. I find that this enhances the bold style and the size of design that I favor.

Though my inlay work is done primarily on commissioned instrument orders, I have had numerous requests to inlay such things as tabletops, lids of boxes, and even the body of an electric guitar, and the following techniques will work equally well for this type of work. My wife, Judith, however, is still waiting for a larger work of inlay to be an objet d'art for our living room. When I do get around to such a project, I'll no doubt enjoy the freedom of a work surface devoid of tuning machines.

**The completed sketch** on tracing paper is shown below. Omitting the dancer's left leg from view gives a sense of her motion. While drawing, I made constant reference to an outline of the peghead, with machine head locations, also done on tracing paper. Placing the outline over or under the drawing easily confirmed that the various parts of the design fell where they should.

The notes on the drawing list the material for each part. I prefer mother-of-pearl for uncovered body parts, and for the dancer's typically non-glossy tights, I chose ivory. A subdued piece of pinkish-white abalone became her dance shoe and a white European curly maple represents her beige crinoline. For the remaining parts of the dress, and for her hair, I chose busy burl veneers, including ash and walnut, that complemented the adjacent materials. Lastly, a small amount of silver, green abalone, and bird's-eye maple formed the belt and blouse.

After tracing and photocopying the outlines of the various parts, I glue each outline to its material to serve as a cutting guide—any

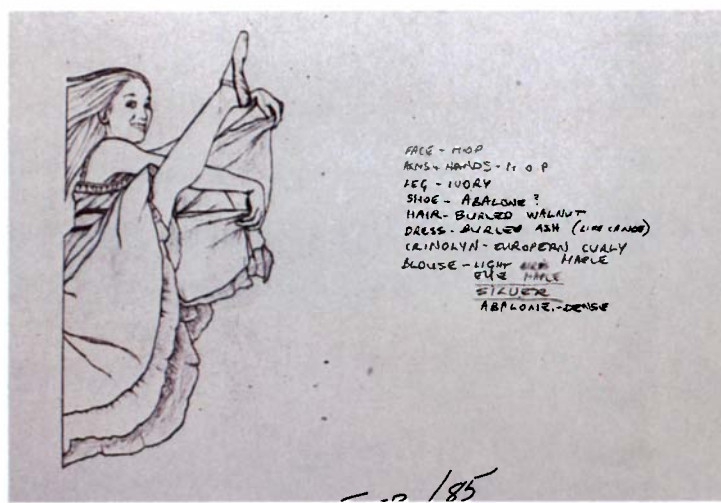

Laskin first works out each peghead figure completely on paper, including inlay materials, which are also listed here.



*Glue the patterns to the inlay materials and cut them carefully with a fret saw (1). Assemble the inlay with cyanoacrylic glue and scribe its position onto the peghead (2). Rout the recess for the background veneer with a small router (3). Cutting just a hair outside the scribe lines prevents fractured inlay later.*



*Glue the inlay in place (4). Plexiglas protects the inlay materials; small wooden spacers distribute pressure. Photo 5 shows Laskin's grip on the graver; photo 6 shows the tool in use. The thumb of the left hand acts as both support and pivot. Work carefully, don't rush, and make sure the graver is always sharp.*



*Engravers' wax gives the engraved lines definition. Rub it over the entire inlay, then immediately rub it off with a rag. Scuff sanding with 240-grit paper prepares the peghead for finish.*

wood glue will do. Trace accurately because the outlines must eventually all fit together. Make several photocopies as insurance against mistakes or breakage. I try to keep all of the materials as thick as, or thicker than, the thinnest one I am using, most often a shell or metal. They'll be sanded flush after they're glued in place.

Mother-of-pearl and abalone shell are normally obtained as "flats" of random size with a thickness of .05 in. or .06 in. To enable any of the dozen or so different burlled veneers I use to be as workable as the stiffer materials, I glue up a double thickness. I buy precious metals in small, 1mm-thick sheets.

I cut the pieces by hand with a fret saw, size "O" blades, and a simple bird's-mouth fixture—a piece of Masonite with a notch cut in it (1, facing page). On tight turns, or just from heating up, the small, brittle blades sometimes snap. A couple of hints: Always keep the saw vertical and in motion, especially on tight curves. Hold the work with your hand, not a clamp; a clamp is too tight and has no give should the blade catch. File with wood or metal files of suitable shapes to smooth out any inaccuracies; shells, ivory and metals file almost as easily as wood. Attach the separate pieces to each other, one at a time, with a fast-acting cyanoacrylate adhesive. Once assembled, the single solid unit will be easily workable.

Glue the assembled inlay temporarily (with only a couple of drops) or clamp it in position to scribe its outline into the ebony veneer on the peghead. I scribe with a small awl-like tool with a fine point (2). I have three reasons for almost always inlaying into black East Indian or Gaboon ebony. One, its natural density allows the small cutting bits of the Dremel router to leave a cleaner edge. Two, its dark color provides a more attractive background for the inlaid materials. Three, it has minimal visible grain, so the edge of filler around the inlay almost disappears.

To excavate for the inlay, I follow the scribed outline freehand with my Dremel mini-router (3). Use straight fluted cutters—a small size to cut the outline, then a larger size to clear the waste. Rout just a hair outside the scribe lines—too tight a fit can result in fractured inlay materials, either at assembly or when the ebony shrinks in dry conditions. The depth of cut should leave the thinnest piece of the inlay slightly proud of the surface.

With the inlay fitted, I secure it in place with epoxy that I've dyed black. Epoxies are readily tinted with standard, finely powdered dyes (available from art supply stores) that slow the curing time. A piece of Plexiglas protects the inlay from the clamps and distributes pressure evenly (4). Small wooden pieces of various thicknesses placed beneath the Plexiglas make up for the differing thicknesses of the materials. Clamp quickly to avoid warping.

Once the epoxy has cured, sand the inlay up to 180-grit paper to flush the surfaces and remove all major scratches before engraving. Drill through the machine head holes now with a spur-tip bit, boring from both sides to avoid chipping the inlay.

I hold the graver as shown in photo 5. My pinky and ring finger are both pushing the ball handle into my palm. With part of your hand pushing against the movement of your arm during a cut, you'll have a large amount of control. Before making any cut with the graver, draw the line in pencil. On the more critical areas, such as facial features, I often draw the part two or three times before I feel it's accurate enough. Notice in photo 6 that the thumb of the left hand acts as a support and/or pivot—a hand position that feels quite comfortable.

When sharpening the graver, work on its cutting edge (the small, shiny, triangular area in photo 6). Sharpening the graver's sides alters its cutting effectiveness. Don't rush when engraving. I spent more than three hours on this particular inlay, the largest chunk of time on the face.



*The completed dancer enlivens the peghead of one of Laskin's steel-string guitars, one of some two dozen guitar and mandolin-family instruments he makes each year.*

Some tips for engraving: First, the graver must always be very sharp or your chances of losing control during a cut increase rapidly. Second, a strong, bold line, especially one with smooth, clean edges, is a confident line. (The exceptions, of course, are when a fine line or tapering line is an integral part of the design.) Third, with materials such as shell or ivory, you must begin with a relatively shallow cut, then deepen and/or widen it with succeeding passes. Attempting to make one deep pass and be done will leave the edges of the cut chattered and chipped. Fourth, the way to accent a line (have it evolve from thin to thick where desired) is simply to lean into the edge of the cut as you deepen it. If your aim is realism, accenting lines is a must.

I cut lines in the various woods with a knife, rather than the graver, which tears the wood. The knife's tip isn't pointed, thereby allowing a thicker part of the blade to pierce the surface when used with normal pressure. As with the graver, make a series of shallow cuts rather than a single, deep one; to widen a line, lean into one side of the cut on a succeeding pass.

After all the lines are cut, an engraver's wax, Monofil (available from jewelers' supply houses), is pushed into them to give them definition (7). Monofil can be obtained in numerous colors, but I find that black most often provides the best definition.

I rub the wax over the entire inlay, then immediately rub it off with a rag. A light scuff sanding with 240-grit paper (zinc-stearate lubricated paper clogs least) removes the 180-grit scratches and the darkened surface of the woods. The inlay is now ready to finish. Before lacquering, I put down a few coats of sanding sealer, primarily to ensure good adhesion to the shell pieces. □

*Grit Laskin makes classical and steel-string guitars, and mandolin-family instruments in Toronto, Canada.*



*French polishing, the venerable technique for applying a shellac finish, produces a high-gloss sheen as yet unmatched by any modern finishing technique. Here, George Frank checks for flaws in the finished surface.*

# French Polishing

## *Applying the ultimate finish*

by George Frank

**I**t was 1922, over 60 years ago, when I was first introduced to French polishing. My teacher couldn't hear or speak, but she was expert in the arts of French polishing and communicating through sign language. When she twirled both ends of her imaginary moustache she was talking about the boss, twirling just one end meant the foreman. She had unprintable words to chastize me for my errors; hugs and kisses were my reward when I was doing well. Two months later, French polishing had no secrets for me. If I could join the areas I've French polished since, I could easily cover three football fields.

In the olden days, before modern lacquers and varnishes, French polishing was the ultimate finish, reserved for fine luxury furniture. Even today, the beauty of this glossy shellac finish is unparalleled, but the skill is not an easy one to acquire. Here, I will convey to you the true French way of French polishing.

**Materials**—Shellac is the main ingredient in French polishing. Shellac's solvent is denatured alcohol. A French-polished finish is extremely durable, but because alcohol is the solvent, a spilled drink can damage it.

Hardware stores sell pre-mixed shellac in cans, but I mix my own so I have complete control over the quality of the ingredients. Dry shellac comes in many grades. I use a grade called superfine orange flakes. These flakes have an unlimited shelf life while dry, and almost as long a shelf life when they are dissolved in alcohol (don't store it in metal containers). On light colored woods, where I want a water-clear finish, I use bleached, or white shellac instead. Dry bleached shellac must be kept very cold and even so, it won't keep long. For this reason, I buy white shellac already mixed, and not more than I can promptly use up. Super blonde flakes, which have an unlimited

shelf life, can be substituted for the perishable white shellac.

Shellac's "cut" refers to the ratio of shellac to alcohol. Three pounds of shellac flakes dissolved in a gallon of alcohol is called 3-lb.-cut, 5 lb. in a gallon is 5-lb.-cut, etc. For French polishing, I make 2½-lb.-cut shellac. For moldings, carvings and turnings I make a heavier, 3½-lb.-cut solution. After mixing, I filter the 3½-lb. cut solution through a clean cloth.

Mineral oil, a petroleum by-product, is used in French polishing as a lubricant. Light-density oil is the best for French polishing—baby oil and lemon oil are also acceptable.

Pumice stone is pulverized volcanic stone used as an abrasive in French polishing. I buy the finest, the FFFF grade.

The French name of French polishing is *vernissage au tampon* (varnishing with a tampon). The tampon, in English, is called a pad, rubber or fad, but none of these are used exactly the same way a tampon is, so allow me to use the French word. The tampon is the French polisher's main tool. It holds the liquid shellac and alcohol and releases them as you squeeze it, or press it against the object to be polished. The inside of the tampon is wool, preferably some old, often-washed knit wool, such as part of a sweater or some white woolen socks. (According to my old notes the best tampons are made of virgin lamb's wool). Before making a new tampon, the wool has to be soaked with the 2½-lb.-cut shellac and hung up for about two hours. Before it dries completely, it must be stored in a tampon can (a tin can with a tightly fitting lid) or in a screw-top jar. A tampon must never dry out completely or it will be ruined.

The tampon is not complete without its outer wrap, which I will call by its old name "linen." Nowadays, our linen is mostly cotton and/or some untraceable man-made cloth. The linen, as we will soon see, plays a crucial part in French polishing.

An array of small secondary items makes the polisher's task easier. On my workbench, I have within easy reach two bottles (about a pint) and a third smaller one. All three have cork stoppers with a thin V-cut in the cork to slowly dispense the contents. I fill one pint bottle with denatured alcohol, and the other with the 2½-lb.-cut shellac. The smaller bottle contains the filtered 3½-lb.-cut shellac. On the workbench are two small tins, one containing 4F pumice stone, the second mineral oil. For dark or red woods (like mahogany) I fill a third tin with mineral oil tinted red or reddish brown with an oil-soluble aniline dye (in the old days, we colored the oil red with alkanet root). First, I dissolve the dye in a small amount of lacquer thinner, then filter out the sediment before adding the dye to the oil.

Under the bench I keep a toolbox containing three or four natural-bristle shellac brushes, a duster-brush, sandpaper (220 grit through 600 grit) and some cheesecloth.

The most important step in mastering the art of French polishing is to understand the theory. A single flake of shellac, when dissolved in alcohol, can be spread over an unbelievably large area. When the alcohol evaporates, the film of shellac remaining on the surface is incredibly thin, dry within seconds, and you can spread a second layer on top of it, a third, fourth or hundredth, and all these layers will melt into one almost immeasurably thin layer. In French polishing, the tampon holds and dispenses the dissolved shellac as it rubs over and over the surface. Meanwhile, the linen retains a bit of pumice and transforms itself into a fine sanding cloth, smoothing the surface simultaneously as it lays down countless layers of shellac.

**French polishing a flat surface**—French polishing could be compared to playing a musical instrument, and no music teacher

would start a beginner with an elaborate tune. Likewise, I strongly suggest that you practice on large, flat boards before you attempt to finish a piece of furniture. The technique is the same for a practice board or the little tabletop in the photos. The legs of the table require a different technique, as I'll explain later.

After sanding thoroughly with 120-grit paper, I sponge the surface sparingly with water to raise the grain. When it's dry, with one-quarter sheet of fresh 150-grit aluminum oxide sandpaper wrapped around my hard rubber sanding block (carpet layers use such rubber blocks to kneel on), I sand at a slight angle to the grain, so as not to push the raised grain back down, but rather to shave off the whiskers. I sandpaper the edges carefully, and break all the sharp corners. Then I sweep away the dust with my dust brush, and check my sanding. Not with my finger tips, but by laying my open palm on the board and moving it around. This way I can detect imperfections not otherwise perceptible.

At this stage, the wood may be dyed, and that's what I did to my little mahogany table. I mixed a water-soluble red/brown aniline dye in water and applied it generously with a piece of soft rubber sponge.

When dry, I sand again with 220- or 280-grit paper. I dust it off once more (not too carefully, since dust does not interfere with French polishing, especially not at the beginning) and I am ready to apply mineral oil.

At this point, I would like to explain that there is a marked difference between the Italian, English and American schools of French polishing and the true French way. These methods coat the raw wood with a heavy layer of shellac and don't use oil at the beginning. The French way always starts by oiling the surface. Using some cheesecloth, I spread on a coat of mineral oil and immediately wipe off the excess.

A finisher always expends his best effort on the surface that will show. Since no one will closely examine the underside of a tabletop, I don't lavish the same attention there as I do on the top. After oiling, I brush the underside with the filtered 3½-lb.-cut shellac. When dry, I build up a film of 2½-lb.-cut shellac with a piece of cheesecloth. It takes about five minutes to build a nice film on the underside. I'm ready to start polishing the top.

French polishing is usually done in three phases. The first phase is the filling of the pores. From my shellac-soaked wool I cut off enough to make a tampon about the size of an egg (larger for a big surface). Then, digging in my box of rags I pull out a piece of linen the size of a small handkerchief. I shape the wool to fit my hand, cover it with the linen and twist the linen tightly around it. From the alcohol bottle, I dribble alcohol onto the bottom of the tampon, and squeeze it into the tampon. The rule of thumb for applying alcohol—the tampon should be moist, but you should not be able to squeeze drops out of it. The downward pressure applied to the tampon shall always be the opposite of the tampon's load. A just fed tampon—very light pressure, a nearly dry tampon... let me quote Olga, my teacher: "When your workbench sinks a half inch into the floor, the pressure is almost enough." I hold the tampon firmly so the thumb, index and middle finger can squeeze it to force out the moisture.

To begin, I fasten the board securely to the workbench, raised





*After dusting a pinch of pumice stone across the surface, the tampon is wet with alcohol and rubbed over and over the surface, filling the pores with pumice and wood dust. When the pores are filled, shellac is introduced to the inside of the tampon, and the rubbing continues, eventually building up a film of shellac.*

on cleats so I can have easy access to the edges. Now, before my tampon contacts the wood, I pick up a pinch of pumice and sprinkle it across the surface. I glide the tampon onto the wood, like a plane coming in for a landing, and keep it moving once it has hit the surface. When I want to stop, I glide the tampon off the surface like a plane taking off. Just putting down and picking up the tampon will leave a mark. Gliding the tampon on, I start pressing the pumice into the pores of the wood, moving the tampon around the board in swirls, endlessly writing WOW, WOW, across the surface, with a few figure 8s thrown in. The tampon must never stop on the surface. This writing isn't limited to the board, in fact, half of the tampon is almost always off the edge of the board. Olga taught me, "Don't worry about the center of the board, it will be done by itself, worry about the edges and the corners."

As I rub, some of the pumice powder enters the microscopic pores of the very smooth wood, but a fair amount sticks to the bottom of the tampon and goes into the openings of the linen. This abrasive linen cuts off the protruding microscopic fibers of the wood, and mixes them into a paste, combining shellac (from the pre-soaked wool inside the tampon), pumice and wood-dust. This compound fills the pores of the wood, blending into it, matching its color and texture to perfection.

After 10 to 15 minutes of rubbing, filling and refilling my tampon with alcohol alone (no shellac) and sparingly salting the board with pumice (very little amounts, but frequently), the surface begins to change. It becomes like frosted glass, smooth and dull. At this point, I have to explain about the light. Imagine the surface as a mirror. I place it so as to see in it some source of light that will allow me to see all details of my progress. Are all the

pores properly filled? Am I leaving heaps of pumice? Did I wash off one coat with the next one? Without proper light, successful French polishing is impossible.

What happens if you put pebbles into a glass of water? Simple, the more pebbles you put in, the more water you force out. At the beginning, the pores of the wood were filled with oil, and now I am refilling them with pumice, shellac and wood dust. The oil spills out and reappears now on the surface, causing it to look like frosted glass, and helping my tampon to glide easier.

When the pores are filled, I begin adding shellac to the wool inside the tampon. I peel off the linen, feed the alcohol first, shellac next (always more alcohol than shellac), then re-cover my tampon, giving the linen a tight twist. I tap the tampon against the back of my hand a few times to even out the moisture. Now I work the shellac and alcohol into the wood. (I never apply shellac to the outside of the tampon, although I will sometimes add alcohol to the outside.)

Whenever the tampon is very dry, I feed it with alcohol and a few drops of shellac and dust a trace of pumice across the board's surface. I am achieving a beautifully smooth surface on which I can easily trace every move of my tampon, since its moves are as readable as the moves of your pen on paper. The oil being forced out of the pores forms faint clouds on the surface that tell me "everything is going well." The finish should always feel dry to the touch.

After I've refilled my tampon three or four times, the shellac buildup is already perceptible and quite shiny. When it is, I touch a drop of oil on the outside of the tampon and continue rubbing. Things begin to happen. Until now, faint clouds marked the passage of my tampon. The droplet of oil that I put on the bottom of my tampon transforms these clouds into easily visible ones. By now the first phase, the filling of the pores, is almost finished, and I've already started the second phase, the bodying. (I timed myself on the tabletop. The filling stage took me approximately 25 minutes, the bodying stage about 15 more.) Now I begin to increase the amount of shellac I add to the inside of my tampon, but never more shellac than alcohol. I also reduce the amount of pumice and, every so often, touch a single drop of oil to the bottom of my tampon. I concentrate on the clouds, which *must* be present on the surface at all times. French polishing has a wonderful rule: Whatever goes wrong, the remedy is alcohol. Remember this well, and practice it. I hardly put any pressure on my freshly filled tampon, but I increase the pressure as the tampon dries. Underneath the clouds, the wood becomes alive and beautiful, it pays me back every bit of effort I put in so far, and with interest.

The edges get a different treatment. In my tampon can, I keep a piece of cheesecloth about 1 ft. square. I wet this generously with 3½-lb.-cut filtered shellac and wipe it over the edges. Repeating this about every five minutes builds up a fair coating on the edges. With my tampon, I skim over the edges time and again. I don't use pumice on the edges, and a bit more oil than on the flat surface. By the time the surface is well bodied up, the edges are in good shape also.

I end up my bodying by filling my tampon once more with alcohol alone and rub until it is quite dry. The alcohol improves the shine and thins the clouds. Incidentally, by this time, the bottom of my tampon is always clean. (If not, the remedy is alcohol). The board is now ready for an overnight rest, and the tampon goes in the tampon can.

The next day I scrutinize my work for poorly filled areas. Beginners frequently have pumice heaps within the finish. These must be sanded off lightly with 600-grit wet or dry paper wet



sparingly with soapy water then dried off well. It is a good idea to go over any and all problem areas with this sandpaper.

The second day operation takes about 20 minutes. The purpose is to correct the shortcomings of the first application and then complete the bodying by adding shellac. I start by feeding the tampon with alcohol only and dusting the board with pumice. The only difference is the quantity. Both alcohol and pumice have to be used much more sparingly than at the beginning. On the other hand, even more care is needed than the first day because the film of finish can be easily ruined. I apply hard pressure and space the "O"s and "W"s so that no spot will be hit again before it has time to dry.

Alcohol, little pumice, great care and the problem areas are fading away. The clouds are appearing again, meaning that once more I am on the right road and that I can resume the bodying. I slowly increase the shellac content of my tampon and add a dab of oil to its bottom.

After about 15 minutes, I replace my linen with a clean, softer "linen" (soft cotton). I stop using oil. This forces me to use extreme care as I land my tampon on the board. I use as little pressure on the tampon as possible. Now, as my tampon dries out, the clouds are thin and they become iridescent. The last two feedings of my tampon are with alcohol alone. I use up every drop of it and the surface smiles at me.

At the start of the third day, the beautiful gloss is somewhat veiled by the clouds of oil. If I am satisfied with the body of my polish, I can proceed with the final clearing. If I feel that additional bodying up would improve the job, I wet my tampon with shellac and alcohol (and maybe a tiny drop of oil, too) and keep up the bodying. When I'm satisfied, I will ease up the shellac feeding and once more, using alcohol alone, I thin-up the clouds to bring up the shine.

My goal now is to eliminate all traces of these clouds and to clear the glossy surface perfectly. For the final clearing, I park my tampon in the tampon can and reach for my special finishing tampon, which I keep in a special tampon can. This special tampon looks just like my regular tampon, except that it is new, and contains no shellac and no oil. The heart of this tampon could be made of a clean, white cotton undershirt or a piece of cheesecloth instead of wool.

First, I sprinkle a light pinch of tripoli earth (a very fine abrasive) on the surface. Wetting the tampon with alcohol, I land it on the board so gently that the board doesn't notice what I did, and wipe off, with imperceptibly increasing pressure, all remainders of the clouds. The job is finished.

**French polishing the pedestal**—Moldings and carved surfaces get a different finish, one more like the English style of French polishing, and I used this technique on the legs and column of my little mahogany table. Had I turned the table column myself, I would have sanded and finished it on the lathe.

After dyeing the pedestal, I sand with 220-grit paper. After applying mineral oil, I brush on a coat of the filtered 3½-lb.-cut shellac. When that is dry I wipe on 2½-lb.-cut shellac with a piece of cheesecloth. Here, I'm trying to fill the pores of the wood with shellac instead of pumice and wood dust. Where I applied only drops to the tampon when I polished the top, here I am liberal with the shellac. After a few minutes, I add mineral oil to the cheesecloth—much more than I used on the top, and a drop of alcohol. The shellac builds quickly and I have a nice shine in a few minutes.

On the second day, I sand the legs and column with 400-grit



*A thicker coat of shellac is built up on the table legs and column using a piece of cheesecloth as an applicator. Then, after sanding with 600-grit paper, a final coat of shellac is applied with a piece of soft foam rubber.*

paper. After brushing off the dust, I rub the legs with cheesecloth using more shellac and more oil. On the third day, I gently sand over the rough spots with 600-grit paper. Using the tampon this time, instead of the cheesecloth, I wet the inside liberally with shellac, apply some alcohol to the outside of the linen and smooth up the legs and column. When that coat is dry, I'm ready for the last step. I add the final gloss by dipping a piece of soft foam-rubber sponge in the filtered 3½-lb.-cut shellac and gently stroking on one smooth, heavy coat of shellac.

For the first 50 years, dusting is the only care that a French polished surface requires. After that, an occasional light wipe with lemon oil or lemon oil cut with turpentine will do fine. □

*George Frank, of South Venice, Fla., is a retired master wood-finisher and author of Adventures in Wood Finishing (1981, Taunton Press). He is currently working on a second book.*

## Sources of supply

French-polishing materials are available by mail from Lee Valley Tools, Garrett Wade, Constantines, Highland Hardware, The Woodworkers' Store and the following companies:

Wood Finishing Supply Co., 1267 Mary Drive, Macedon, N.Y. 14502

Olde Mill Cabinet Shoppe, RD 3, Box 547A, York, Pa. 17402

Mohawk Finishing Products, Inc., Route 30 North, Amsterdam, N.Y. 12010



# The Old Schwamb Mill

*A place for skilled hands in the Industrial Age*

by William Tandy Young

It's a blistering July afternoon, and the second floor gluing room at the Old Schwamb Mill is a clapboard furnace. Working to assemble a picture frame before the fast drying Tite-bond sets, I imagine that the beads of dripped hide glue that have built up like coral on the benches and floor of the room since the Civil War will begin to glisten and move if it gets any hotter. Outside, kids with the summer off lounge against the sluice gate and embankments of the stream that runs behind the mill on its way through Arlington, Mass., and into Boston Harbor.

Were it closer to 1864, when the skilled German immigrant brothers Charles and Frederick Schwamb began working wood in

this building, the scene would be somewhat different. The kids might be at a farm or another mill downstream, working for a wage. The stream itself would be powering the mill and other enterprises along the waterway. And I, as one of thirty workers in these cramped quarters, would be furiously brushing that hot glue and clamping work before it gelled, with the room being sealed and heated to a year-round hundred degrees plus to keep the glue workable. Pressure to produce was intense; outside in the yard, where today a few cars dot the parking lot, there used to be stacks of lumber so large that mapmakers drew them as buildings.

The industrialization of woodworking in America was still



*Young demonstrates oval turning on one of the Old Schwamb Mill's eccentric lathes, facing page. In its heyday, up to 30 workers would have made the Mill hum, turning out high-style frames such as the ones shown above. The old system of jackshaft and belts, at lower right, still drives most of the machinery, but two 7-HP electric motors have replaced the waterwheel as the source of power.*

gaining momentum when the Schwamb brothers took over the site, which was originally developed in 1650. Saved from demolition in 1969 by mill director Patricia C. Fitzmaurice and other members of the Schwamb Mill Preservation Trust, the mill is now listed in the National Register of Historic Places—a working museum, open to the public. The Mill carries on today as the country's oldest and leading maker of the hand-turned oval and circular portrait and mirror frames that were once essential to high-style interiors. The Mill is an authentic capsule record of the developing Machine Age, one of the few remaining examples of the thousands of small, family-owned mills that once proliferated along moving waterways throughout the land.

While the mainstream demand for handmade oval and circular frames is gone, the Mill continues to produce them for museums and collectors, using the 19th-century machines that dominate the ground floor. There are no toys among these fixed pieces; they include a 24-in. patternmakers' jointer, a 36-in. bandsaw and a double-spindle shaper with a 4-ft. by 6-ft. table. Patterns, jigs, saw blades and cutters abound, and the entire northwest corner of the room is taken over by molding knives, arranged in rows and in pigeonholes with sample cuts, each labeled with a customer's name, not a job or catalog number. It's a system that must only have been fully understood by the molding men themselves.

Two main pulley shafts, one overhead and one below the main

floor, drive most of the machinery via metal-laced leather belts that shuttle from idler to drive pulleys to engage individual machines. Where once water, then steam systems powered the pulleys, now two discreet 7-HP electric motors do the job. Babbitt and split-bronze bearings still prevail—during regular maintenance sessions, the machine room can become a forest of oil fills, wicks, dams and catch cups to whoever has to clamber among the machines, squeeze between bracings, or hang from empty girt mortises with one hand on a pump oiler (surely once the job of a twelve-year-old).

The hardest machines to maintain are the elliptical faceplate lathes, in a family of sizes, that were once the heart of the Schwamb operation and that are, today, easily the objects of greatest interest. The faceplate mechanisms are as mechanically other-worldly as the innards of a gyrating carnival ride. At these stout headstocks, the most skillful Schwamb employees stood side by side the day long, scraping profiles and rabbets into glued up oval or circular frame blanks.

The turners worked briskly at daylight work stations—which they could not desert—to earn a workaday wage. Many of the profiles required extensive layout, fancy eyesight, a good sense of proportion and delicate, whole-body movements to execute. To those who are convinced of a wholesale disappearance of elevated hand skills in the burgeoning Machine Age, one can counter that these

## How an eccentric lathe works

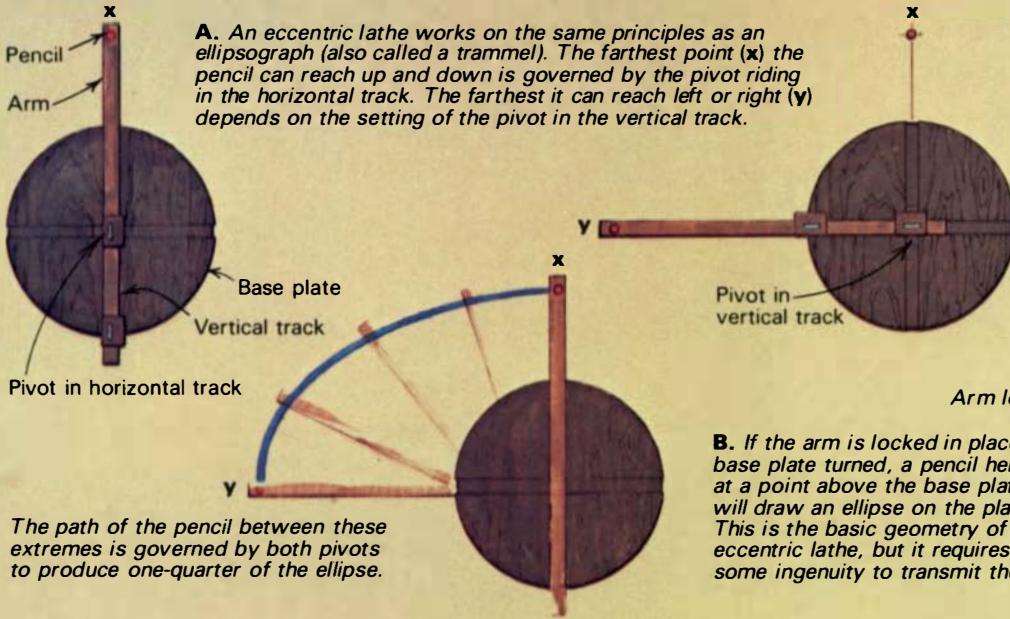

**A.** An eccentric lathe works on the same principles as an ellipsograph (also called a trammel). The farthest point (x) the pencil can reach up and down is governed by the pivot riding in the horizontal track. The farthest it can reach left or right (y) depends on the setting of the pivot in the vertical track.

The path of the pencil between these extremes is governed by both pivots to produce one-quarter of the ellipse.

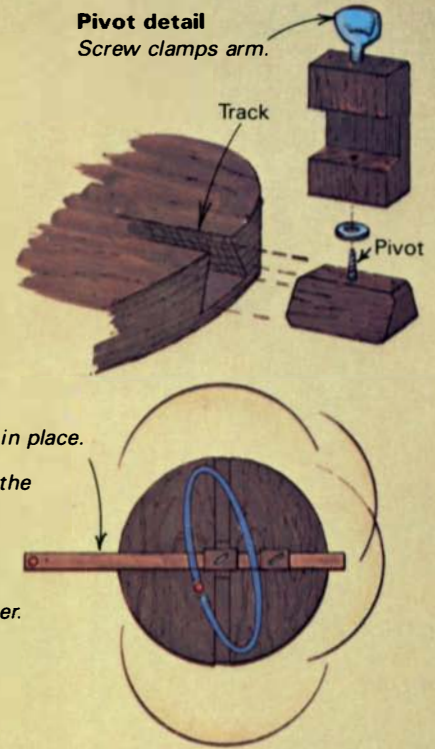

**B.** If the arm is locked in place and the base plate turned, a pencil held at a point above the base plate will draw an ellipse on the plate. This is the basic geometry of an eccentric lathe, but it requires some ingenuity to transmit the power.

**C.** The eccentric lathe's headstock spindle is surrounded by a round ring on a plate that can be shifted off-center. If the ring is centered, the lathe will turn a circle. The farther off-center the ring is mounted, the narrower the ellipse.

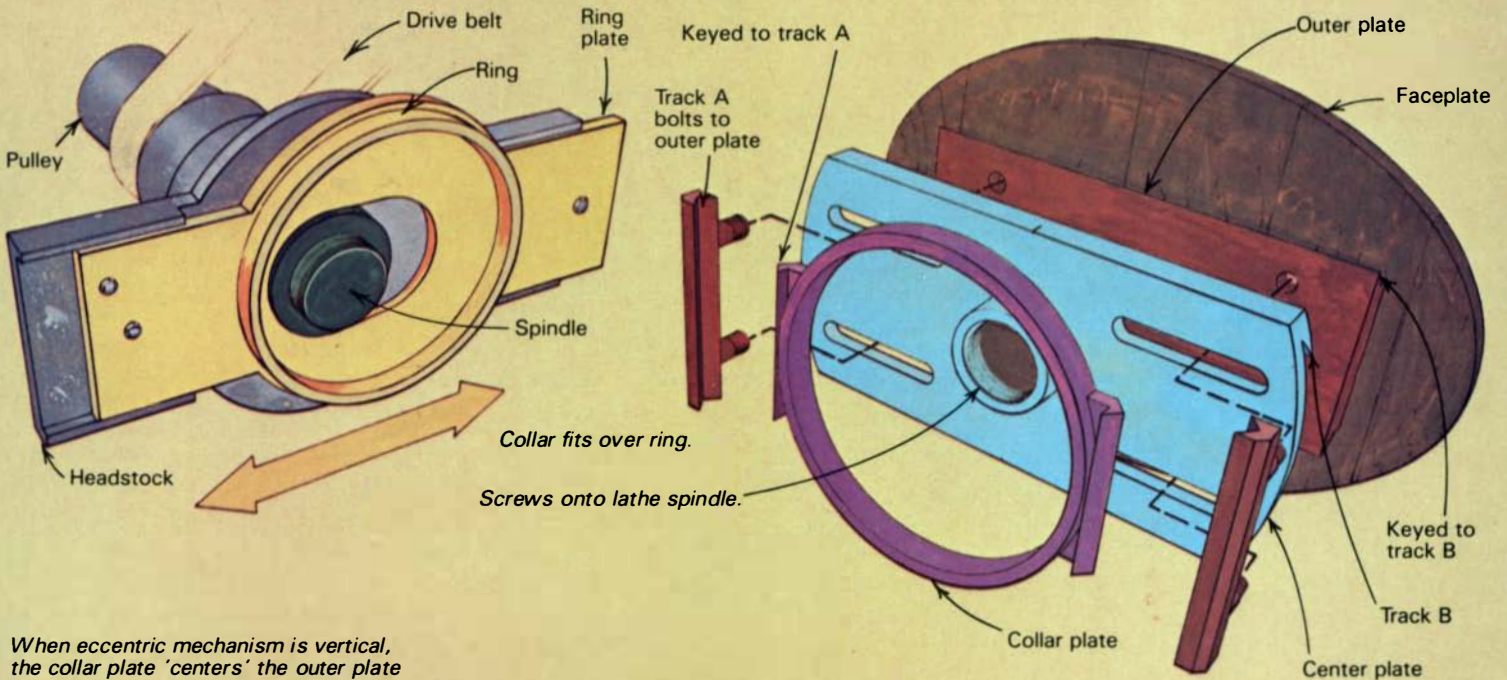

When eccentric mechanism is vertical, the collar plate 'centers' the outer plate and the faceplate.

When mechanism is horizontal, collar forces the faceplate 'off center,' while cutting tool remains at same distance from center of spindle.

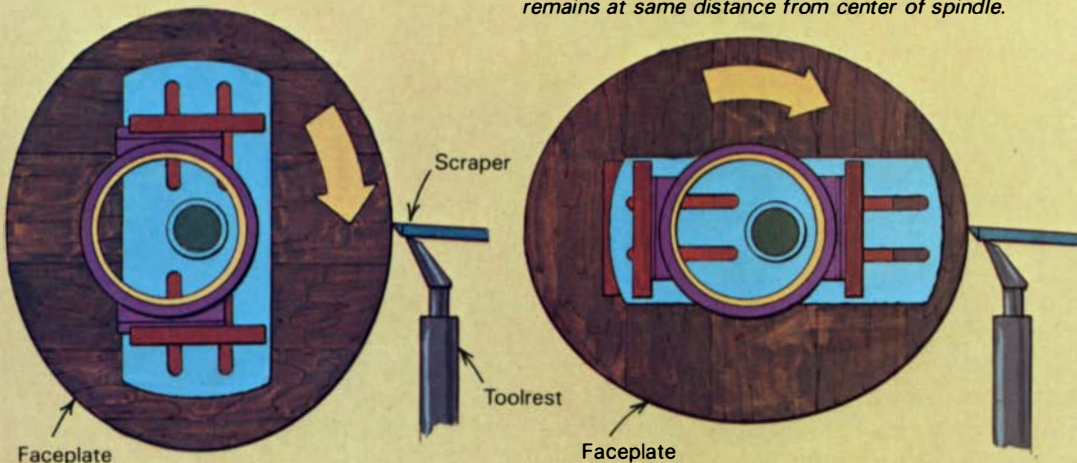

**D.** The eccentric mechanism consists of three plates keyed to each other along perpendicular axes. The collar fits over the ring on the headstock, and the outer plate is a flat surface to which the faceplate is attached. The center plate is screwed to the lathe's headstock spindle—it turns in a circle and acts as an idler on which the collar and outer plate can move. As the lathe turns, the collar is forced to move in relation to the center plate, as shown at left, so the path of the faceplate is an ellipse.

people represented a high marriage of artisanry to industry, a refined manual approach to a repetitive specialized task not unlike the job context of a senior journeyman in a pre-industrial shop. Certainly, early industrial America did not develop a sudden independence from hand skill, and within certain workplaces, the uses of machinery added to the skill vocabulary rather than depleted it.

The elliptical lathes have been difficult to document. There are no casting numbers nor maker's stamps, and research into their past has shown only that there is no record of a patent for their design or manufacture in this country. As elliptical turning technology is known to have existed in Europe at the time, the Schwambs or others quite likely brought the knowledge of it with them and re-created the machinery here. Whatever their origin, the lathes are best understood as a means of transforming circular motion into elliptical motion. How this is done is explained in a simplified way on the facing page.

An oval form may be turned from a toolrest just as a circular one would be. While this is a distinct, singular capacity to have at one's disposal, for those imagining the glory of cutting into fine stock on venerable machinery, wonder not. The work is all scraping, lathe speeds are low, work must proceed in a rigidly ordered sequence to be effective or profitable at all, and often the turner is faced with the necessity to simply force the cut.

The lathes, though worn, permit the Old Schwamb Mill to satisfy demands that no production shop could. Orders now come in from around the continental United States, Hawaii, and from abroad, complementing and extending the body of work previously produced, which is included in the collections of The White House, the Vatican, Buckingham Palace, and the Boston Museum of Fine Arts, among others.

A typical order might be: one gold-leafed oval mirror frame, turned with profile number 558 (from the Schwamb production collection) and having a 16-in. by 20-in. inside dimension.

The first task is to develop a template for one quadrant of the ellipse. Schwamb ellipses (and circles) are constructed of regular quadrants of kiln-dried lumber, bandsawn and finger-jointed. One template serves for the whole job, and is gotten from the quietest corner of the main floor, where a trammel board rests on an oak cask. The surrounding walls are an orderly fish-scale jam of the cardboard quadrant arcs that the Schwambs cut over the years.

If a pre-made template can't be found in the array, the trammel is set to size and a new template is cut, then traced on the stock. The four sections of the frame are bandsawn, jointed flat, and cut to length on a sliding-table circular saw.

The finger joint is made on a gang saw, a set of blades with teeth protruding through a wooden plate and between two fixed parallel wooden fences. Each quadrant is gripped like a pistol and pushed through the blades.

Frame blanks are taken upstairs to the glue room as soon as the joints are cut. Here, amid the iron heat pipes and old hide-glue pots, quadrants are ganged up face to face, Titebond is brushed on the joints, and the frame is loosely pieced together on a steel-topped assembly table. A steel band clamp at one of several stations is placed around the frame blank and drawn up quickly with a handwheel, which winds in the slack. The quadrants align, the shoulders draw up, and beads of glue bloom at the joints as the strap comes to full tension.

After overnight curing, glue-squeeze is chiseled away from the back of the blank, which is then jointed flat so it can be mounted on the lathe faceplate. Frame blanks are fixed to the lathe with four screws positioned so they will neither come through a finger joint nor be exposed during turning. The lathe differential,



*The first step in making an oval is to make a pattern. This old trammel board, above, is adjustable to draw ovals (and circles) from a few inches wide up to 4 ft. long. The four identical segments that make up an oval frame are finger-jointed on the venerable gang saw shown below, but today's blades are carbide-tipped.*

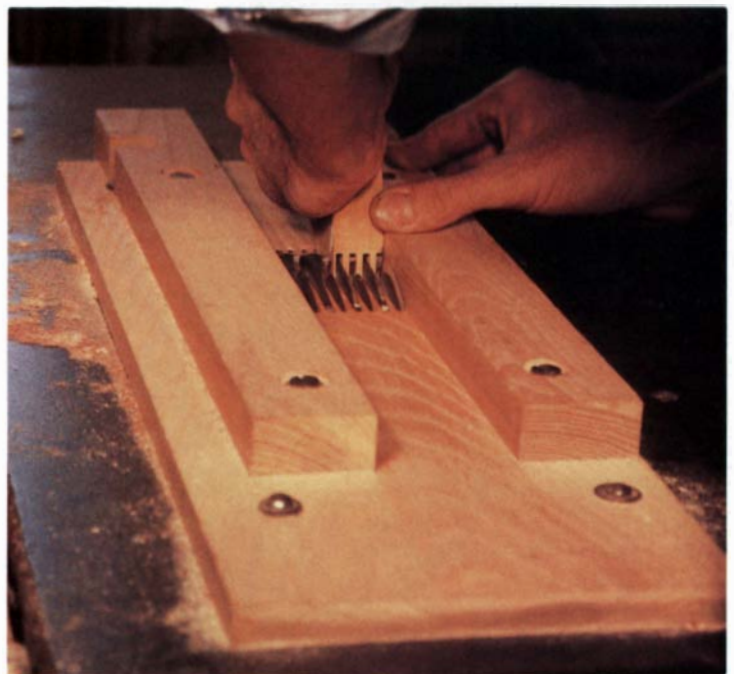

which governs the proportions of the oval, is set by moving the headstock ring plate to the proper calibration. After a liberal oiling of the mechanism bearing surfaces, the blank is rotated, test-marked and the setting checked for accuracy.

The lathes all run considerably under 1,000 RPM. Low speeds are easy on the equipment, but dictate several turning challenges. The action of worn ellipse mechanisms can become exaggerated, tools grab more easily, and scraping smooth surfaces is more difficult than at higher speeds. Nevertheless, turning circles or moderate ovals is usually a pleasant, direct joy, free of the racy hum and tense power delivery of the typical light modern lathe.

Tools for any order are chosen from the Mill's collection. All



*The display may be reminiscent of a barn sale, but these tools are in everyday use, turning out oval frames to match patterns that were drawn and cataloged by the Schwambs 150 years ago.*

of these were shopmade from tempered bar stock, with plain handles, iron ferrules, and usually with nails banged in around the tang to take up slack caused by generations of turning. Scraping burrs are turned over without fuss at the nearby grinder, and must be touched up constantly.

To dimension the blank accurately, the face is trued flat and to final frame thickness. A slightly dome-shaped scraper is the first tool used. It bangs the glue off the joint shoulders and takes away “fat” areas of the face, caused by the lathe’s deflection from vertical as the old mechanism spins. The worn devices often yield frames with pleasing, subtle inconsistencies such as varying thickness or imprecise elliptical orbits.

A spear-point tool is then used to make planing cuts across the face until final thickness is reached. None of these cuts can be heavy, else the drive belt will slip (leather and wood have no easy time driving the lathes). Watching the tool at work has often reminded me of a phonograph needle moving across a record.

After the face is cut, the inside or “sight” edge is made square to it and sized to the ordered dimensions, again with the spear-point tool. Tool position and angle are critical. There is only one small zone in the entire path of the turning blank when the stock is moving straight down in relation to the toolrest. Within this zone, which is as wide as the toolrest and perhaps an inch in height, the work can be cut as if it were a circular turning. Outside the zone the work also moves sideways, which makes cutting impossible. The turner must choose a particular angle to use from the toolrest to the work in penciling layout lines and making cuts. This angle, once chosen, must be maintained throughout the job. If the tool angle is changed, different cuts will have changing relationships to each other, making the molding elements appear to be in slightly different orbits.

Now, with the sight edge having been cut, the final frame

width is marked on the stock and the outside edge is cut the same way, with the same attention being paid to squareness and to the tool angle.

Next, the rabbet is cut with a special right-angle scraping tool. The developing rabbet quickly fills with centrifugally held scrapings, giving the illusion that making the final depth will take but a moment. In reality, the cutter will lose some length to the grinder before the job is done.

With the rabbet cut, the dimensioned oval blank awaits a profile. Full-size section drawings either come to the machine room with each order, or are specified by catalog number from the Schwamb collection. Most profiles are begun as step cuts, which are made square and parallel to the faceplate with the spear-point tool. The final coves, ogees, beads and other shapes are cut into the steps using the full kit of Schwamb tools. (It is a pleasure to turn an obscure molding for the first time and in the process finally discover the true purpose of a particular odd, neglected tool.)

The tools encounter endgrain and glue four times per revolution on an average cut. Some tearout is inevitable, but can be minimized by touching up the burr frequently. A dulling tool will soon begin to bounce around in the cut, and will remove material unevenly, causing the same off-kilter appearance as a change in the tool angle. The goal is to do all shaping with the cut, not with subsequent abrasives. Sanding the work on the lathe is a rocky necessity that one strives to keep to a minimum—in the best of worlds, sanding would not be necessary to make beads round or to fair coves, but some frames require it.

When the frame is done, it is unscrewed from the faceplate and brought upstairs for finishing. The floor is swept, the tools put in their places, then the cycle begins again.

The mill’s workday used to begin around dawn, when the first workers arrived to ready the day’s supply of glue. In pre-electric times, work hours and shop layout were controlled by the sun. But I find myself working at a time of day when no 19th-century woodworker would have thought of being in the room. On this winter evening, the Schwamb machines seem like darkened props on a stage out of context. Wire-caged lightbulbs hang from their cords over each machine, and are switched on and off as the work proceeds from one station to the next. The sounds of the structure shift as if under sail, conjuring thoughts of the thirty-at-once who filled these buildings, whose hands wore the flatness and edges from every surface. Tidal cold drafts break in through the clapboards and window frames, rattle the quoit-like collection of failed turnings hanging from the beams, flutter the faded girlie poster and help erode the years of milestones and messages chalked on planks and timbers throughout the framework: first snows, machine safety, company policy.

The upper atmosphere of the room is charged with pulley movement as the whole mill becomes the machine. The slapping belts cadence the work; the 60-watt baskets swing. Sweeps and lands of an emerging profile glance in and out of moving shadow as they spin, and oval pencil lines seem to hula into barely confluent duplicates. The deepening chill of the wind from the faceplate has matched that of the drafts. Working at the old machines for any length of time gives a bone-felt glimpse into the age that begat the works. I rebreathe the breath, regrip the tool, engage the blur. □

*William Tandy Young makes furniture in Arlington, Mass. The Old Schwamb Mill, open weekdays from 10 A.M. to 4 P.M., is at 17 Mill Lane in Arlington, Mass., near 1215 Massachusetts Avenue. For group tours, call (617) 643-0554.*

# Woodworking at the Dairy Barn

*Ohio gallery mounts national show*

by Roger Holmes



**Barry Yavener's writing table and chair began with his interest in tapered parallelograms, rather than in writing or sitting. The shape suggested a leg and the furniture grew from there. Yavener, who teaches three-dimensional design at the State University College in Buffalo, N.Y., joined the two pieces that make up each leg with a triple tenon. The angled stretcher joinery was, Yavener says, a nightmare. The wood is West African boire; Yavener did the velvet upholstery himself.**

**T**he Dairy Barn in Athens, Ohio, filled its 7,000 square feet of uninterrupted gallery space with woodworking last fall: 109 pieces of furniture and sculpture, the work of 79 makers from 25 states. In only its second year, the Dairy Barn show has become one of the biggest and most ambitious shows in the country.

Located on the edge of Athens, a small Southeastern Ohio town set in lovely Appalachian hill country, the Dairy Barn is the only survivor of a cluster of five similar barns built around 1914 for the nearby Athens Mental Health Center's therapy program. In 1978, a group of local artists and craftworkers recog-

nized the building's potential, rescued the barn from the wrecker and established the non-profit Dairy Barn Southeastern Ohio Cultural Arts Center.

With the big building came big ideas, and within a year the Dairy Barn had mounted a national exhibition of contemporary quilts, one of the first of its scope in the country. The success of the quilt shows (there have been four to date) encouraged Dairy Barn director, Pamela Parker, and a group of local woodworkers to try the same approach with furniture.

It is one thing to gather quilts from thousands of miles away, quite another to do the same for woodworks. Shipping risks and



Chris Eaton



◆ William Bartoo, of Fredonia, N.Y., got a lot of mileage out of the elements of this little bird's-eye maple side table. Structure, decoration, and function fit seamlessly together. Two legs are through-dovetailed to the top, a third shows an exposed bridle joint; curved purpleheart stretchers stiffen the structure—all work to hold the thing together and to please the eye.

◆ Randall Fields, who did a fine job designing the Dairy Barn show installation, makes about two dozen Windsor chairs and some 100 stools each year in Amesville, Ohio. Fields combines hand and machine methods to make chairs in the spirit of, rather than to the letter of, the Windsor tradition. "The only reason 18th-century Windsor's weren't painted metallic maroon," Fields explained with a smile, "is because they didn't have it back then."



John Casey

◆ John Casey's slightly crazed *Conan Table #2* is good fun. Casey, who works in Kent, Ohio, was teaching philosophy at Iowa State when the woodworking bug bit him in 1971. The table combines cherry, vermilion, osage orange, and rosewood with some contemporary mythology. "Today nobody's going to know the Greek myths that were used to decorate tables in the 1800s," he told me, "but everybody's going to know Conan, by God." The laminated stretchers are wrapped around the legs—the veneer is glued to itself, not to the leg.

◆ Susan Pfeiffer was so pleased with the effect bleach had on wenge, that she designed this piece to show it off. Pfeiffer, an M.F.A. student at Arizona State University in Tempe, form-laminated the drawer and bandsawed its case. Pulling the little ebony pin at the mirror's apex frees the top wedge and splits the frame to allow replacement of the mirror.



Charles Lipschutz





Mel Mircemiller

◆ Brad Gray's beech and soft maple table was one of the few 'rustic' pieces in the show, and I found it a welcome relief. Gray, who works from his rural Stout, Ohio, home, attached the legs to crossed supports screwed to the tabletop. I liked the piece, but not the rather heavy-film finish Gray had applied. When I asked him about it, Gray said he chose the finish only because he felt that high gloss was what show judges were looking for.

◆ Best of Show, and its \$1,000 prize, went to James Pritchard's portrait of his wife, Laurel. Pritchard, of Dublin, N.H., once built custom homes, then turned to portrait sculpture. There wasn't much money in it, so he now carves signs for a living. He does a couple of portraits a year. This one is basswood, the silhouette painted ply.

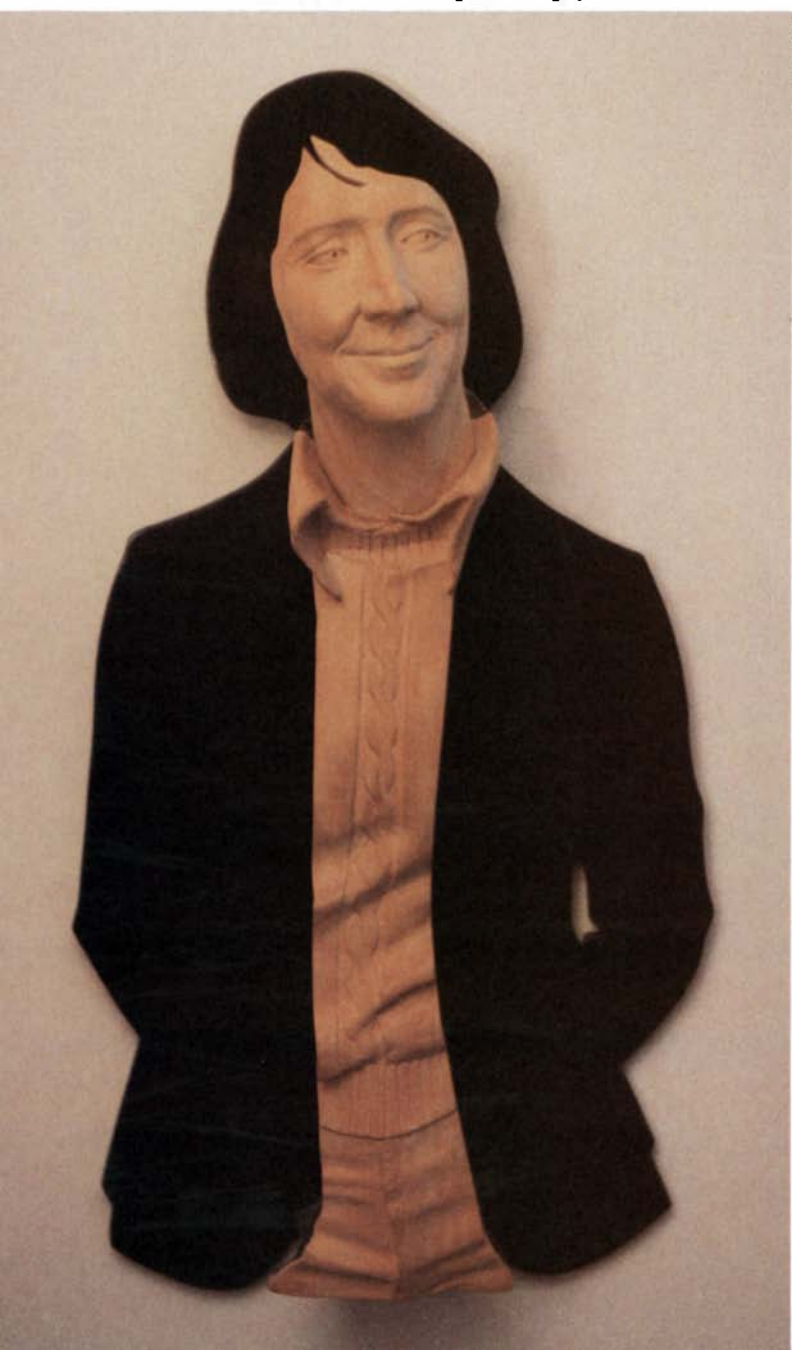

Laurel Pritchard

costs have dampened the enthusiasm of numerous gallery directors, but Parker and exhibition coordinator, Ann Donohoe, persisted, convincing makers it would be worth their while to bear the cost. Looking ahead, Parker hopes to convince a corporation or two to underwrite costs for subsequent shows.

This year's show was juried by Sam Maloof, Jonathan Fairbanks, Boston Museum of Fine Arts curator, and David Hostetler, a sculptor and art professor at Ohio University in Athens. They pruned the 250 submissions down to size. Nine nationally-known makers were invited to round out the show. The result was impressive. The quality of design and workmanship was high. While most of the furniture lacked the glamour of art-market pieces, it seemed to me to have considerable appeal for people looking for something useful that can also be appreciated for more than its utility.

When a piece didn't work for me, it was, as often as not, because its execution fell short of its design, or vice versa. Several good designs suffered from imprecise making, lacking the crispness necessary to pull off delicate details or to show simple lines to best advantage. Other well executed pieces seemed ill-proportioned or altogether ill-conceived, technique in search of purpose.

For the most part, however, the pieces succeeded; some extremely well. William Bartoo's side table, (facing page) is a fine example of structure as decoration. Barry Yavener's elegant writing table and chair, (p. 79), are sophisticated pieces, well executed. They are also fairly complicated constructions which, nonetheless, have an overall look of simplicity.

Several makers took traditional pieces as points of departure. Randall Field's Windsor (facing page) doesn't stray too far from the originals. John Casey, however, gave the Federal period a thorough reworking in his *Conan Table #2*. One of my favorite pieces was Susan Pfeiffer's little make-up mirror. It is whimsical and not overwrought, and the combination of bleached wenge and ash, with their similar textures and contrasting colors, is pleasing. The mirror, particularly its cloven feet, gave me a chuckle, which Pfeiffer says was just what she intended.

There were quite a few sculptures, and sculptors walked off with all four show prizes. Best in show went to James Pritchard's portrait of his wife (bottom left), an ingenious piece that sets a carved face and torso about 4 in. in front of a flat black silhouette. Viewed straight on, the parts merge for a full portrait; viewed from other angles, the carving has a presence of its own. Pritchard's wife was a tough critic. "The main difficulty in portrait sculpture is obtaining a likeness pleasing to the model," Pritchard says in an exhibition note, "but in this case she simply sneaked down at night and sanded out whatever feature she found objectionable."

The chance to see and compare, in one place, work from across the country is rare. If the work at the Dairy Barn wasn't pushing many design or technical limits, that, to me at least, was part of the point—most woodworking around the country isn't. The show was greater than the sum of its parts, and much of the interest it held for me was in its geographic diversity. Parker says she hopes future shows will attract more avant-garde work. I think this would be a good thing, but only if it's not at the expense of "ordinary" work, work that would be comfortable in most homes, work that people could expect to see if they toured the better workshops in their area. □

Roger Holmes is an associate editor of *Fine Woodworking*. The Dairy Barn's third national wood show will run September 13 to October 12. Entry deadline is June 12. For information, contact the Dairy Barn, P.O. Box 747, Athens, Ohio 45701.

RYOBI TOOLS		List	Sale
S500A	3x5/2 Finish Sander	70	41
SU6200	Finishing Sand. 1/2 Sheet	142	88
87075	3x2 1/4 dustless Belt Sand.	179	116
87100	3x2 1/4 dustless Belt Sand.	208	140
B7200A	4x2 1/4 dustless Belt Sand.	269	165
D100VR	3/8" VSR 0-1200 rpm drill.	91	49
W740	7/4" 13 amp circular saw	158	99
J560	8 1/4" 13 amp circular saw	171	109
J560	Jig Saw-Single Speed	172	99
R150	Jig Saw-electronic v/speed	198	123
R330	1 H.P. Plunge Router	138	86
R500	2 H.P. Router	220	138
E3800	3 H.P. Router	265	163
L120U	Drywall screwdriver 0-4000	126	79
	3 1/2" Planer	142	89
801020R	3/8" 2-spnd Cordless Drill w/free holster-Xtra special buy	148	95
TS251U	10" Mitre Box	300	169
S61150C	4 1/2" H.D. Mini-Grinder	99	59

**YOUR ATTENTION PLEASE!**  
All Above RYOBI TOOL Prices  
Take Additional 10% OFF Sale Prices

MILWAUKEE TOOLS		List	Sale
0224-1	3/8 drill 4.5A magnum	159	109
0234-1	1/2 drill 4.5A magnum	159	112
0244-1	1/2 drill 4.5A magnum	159	115
0222-1	3/8 drill 3.3A 0-100 rpm	146	99
0228-1	3/8 drill 3.3A 0-1000 rpm	129	92
0375-1	3/8 close quarter drill		
	— NEW — 3.5 amp	175	118
0210-1	3/8 cordless drill		
	— NEW — 2 speed	154	95
6539-1	cordless screwdriver		
	— NEW — 190 RPM	84	59
1007-1	1/2" drill 4.5A D-Hdle	199	145
1107-1	1/2" drill 4.5A D-Hdle	204	145
3300-1	magnum rt angle drive kit	249	170
3102-1	Pimbers rt angle drill kit	263	180
1676-1	HD Hole Hawg w/cse 2 sp	333	235
5395	3/8 sgle sp hammer drill ki	203	150
5397	3/8 var sp hammer drill ki	208	155
5371-1	HD mag. hammer drill 1/2"	287	207
5373	HD mag. ham. drill 3/8"	240	175
6511	2 speed Sawzall w/case	181	122
6226	port band saw 2 sp w/case	382	280
6234	TSC band saw port w/case	382	280
6405	8 1/4" circ. saw 13 amp	179	127
6460	10 1/4" 15 amp w/case	349	245
6165	12" Chop saw 15 amp		
	4200 R.P.M.	285	189
6255	v/sp Jig Saw 3.8 amp	199	140
6245	sgle sp Jig Saw 3.8 amp	175	125
6012	1/2 sheet HD Orb. sander	159	110
6014	1/2 sheet HD orb. sander	169	112
5660	1 1/2" HP router 10 amp	265	175
5680	2 HP router 12 amp	314	220

DRYWALL SHOOTERS		List	Sale
6753-1	3.5 amp 0-4000 rpm new	115	79
6747-1	4.5 amp 2500 rpm	144	100
6750-1	4.5 amp 0-4000 rpm	129	90

**NEW FROM RYOBI**  
MODEL AP-10 — 10" Surface Planer  
WEIGHTS ONLY 58 LBS.  
LIST 659.00 — SALE 375.00

MILWAUKEE Super Specials!		Model	List	Sale
6377	7 1/4" worm saw 13A		259	142
6378	8 1/4" worm saw 13A		269	148
— NO DEALERS PLEASE! — = WHILE SUPPLY LASTS =				
<b>Go Cordless with MILWAUKEE</b>				
#6305 — 6 1/4" Cordless Circular Saw				
12 volt — 1 Hour Charge				
Cuts (80) 2x4's (Pine)				
List Price 195.00 * SALE PRICE 119.00				

**FREUD SAW BLADES**  
Unlv. Bore — Professional Series  
**CARBIDE TIPPED SAWBLADES**

Item No.	Description	Diam.	Teeth	List	Sale
PS203	Gen'l Purp.	1 1/2"	24	27.24	17.50
PS303	Fine cutting	1 1/4"	40	32.97	20.50

5/8" Bore — Industrial Grade		Item No.	Description	Diam.	Teeth	List	Sale
CARBIDE TIPPED SAWBLADES							
L072M010	Gen-1 Purp.	10"	40	68.58	34		
L081M010	Gen-1 Purp.	10"	40	69.30	35		
L073M010	Cut-Off	10"	60	79.65	36		
L082M010	Cut-Off	10"	60	86.40	44		
L084M010	Combination	10"	40	70.99	36		
L084M011	Combination	10"	50	74.51	37		
L085M010	Super Cut-Off	10"	80	110.88	62		
LM72010	Ripping	10"	24	64.85	34		
DS 306	6" Dado			139.00	92		
DS 308	8" Dado			170.00	105		
TR 100	3 blades & Dado set			399.00	255		

MAKITA CORDLESS FESTIVAL OF VALUES		Model	List	Sale
43000W	Jig Saw		158	99
5081DW	3/8" Saw Kit		174	95
56000W	6 1/4" Circular Saw		224	125
9035DW	Finishing Sander		129	73
60100DK	3/8" Cordless Drill Kit		152	88
6010SDW	3/8" Cordless Drill		84	45
84000W	3/8" Hammer Drill		188	105
DA30000W	3/8" Angle Drill		176	98
60100L	3/8" Drill w/Flashlight		162	89
6012HDW	3/8" 2 spnd Driver Drill w/Bat & Metal Case		178	98
DK1002	3/8" Drill w/Fluornt Lt.		164	90
67100W	Cordless Screwdr Kit		148	84

DELTA BENCH TOP TOOLS		Model	List	Sale
11-950	8" Bench Drill Press		124	100
28-160	10" Bench Band Saw		158	125
40-500	15" Scroll Saw		105	85
23-660	6" Grinder Bench		62	50
23-880	8" Grinder Bench		99	85

MAKITA TOOLS		List	Sale
804510	Sander	79	43
99008	3" x 2 1/4" belt sander	198	119
99248	3" x 2 1/4" belt sander	189	130
992408	3" x 2 1/4" b/sand. w/bag	214	130
9035	1/2 sheet finish sander	79	48
90458	1/2 sheet finish sander	156	90
9045N	1/4 sht fin. sand. w/bag	158	105
4200N	4 3/8 circ. saw 7.5 amp	152	93
5008NB	8 1/4 circ. saw 13 amp	178	105
4201NA	10 1/4 circ. saw 12 amp	348	215
5008WB	v/sp jig saw 3.5 amp	192	120
43018V	orbv/sp jigsaw 3.5 amp	208	125
JR3000WL	2 sp recip saw w/cse	168	120
JR3000V	vs recip saw w/case	178	120

MILWAUKEE SPECIAL PROMOTION		Model	List	Sale
LS1000	New 10" Mitre Box		348	198
792210-7A	Carbide Bid for above		45	31
9820-2	Blade Sharpener		244	159
741074-9	60 (coarse) Grd Whl		33	23
741070-7	1000 (med) Grd Whl		30	22
741071-5	6000 (fine) Grd Whl		43	30

DELTA 10" Contractor's Saw		Model	List	Sale
34-110	10" Contractor's Saw		649.00	549.00
Less Factory Rebate..... 100.00				
*** DELIVERED ***				

DELTA		Model	List	Sale
34-612	9" contr. saw w/o motor		500	395
34-710	super 10" motorized saw		579	450
15-091	15" floor model D/press		467	375
15-090	15" bench model D/press		467	375
37-207	Saw/Joiner Combination		1018	810
37-609	6" Motorized Joiner		413	335
37-290	4" Joiner w/o motor		346	275
22-651	RC-33 — 13" Planer		1943	1450
43-122	Wood Shaper w/stand and 1 H.P. Motor		689	495
46-140	11" lathe, gap bed model w/stand w/o motor		407	335
52-493	1 hp motor for #34-612		170	130
62-144	1/2 hp motor for #37-290		136	105
62-142	1/2 hp motor for #28-243 and #46-140		121	85

**1986 TOOL CATALOG AVAILABLE**  
Call Toll-Free 1-800-328-0457 — In Minnesota Call (612) 224-4859  
4 WAYS TO BUY: CHECK — MONEY ORDER — VISA — MASTERCARD  
**SEVEN CORNERS ACE HDW., Inc.**  
216 West 7th St. • St. Paul, MN 55102 • Est. 1933

SAW-ATHON by PORTERCABLE		Model	List	Sale
#314	4 1/2" Trim Saw		180	109
#346-1	6 1/2" Top Hdle		161	100
#617	7 1/4" Push Hdle		166	96
#587	7 1/4" Speedtronic		199	125
#315-1	7 1/4" Top Hdle		176	110
#368-1	8 1/4" Top Hdle		176	110

DELTA SUPER SPECIALS!		Model	List	Sale
#33-150	SAWBUCK		656	499

DELTA 10" Contractor's Saw		Model	List	Sale
34-110	10" Contractor's Saw		649.00	549.00
Complete w/62-042 1 1/2 HP Motor				
One-time Special..... 649.00				
Less Factory Rebate..... 100.00				
*** DELIVERED ***				

**TOOLS ON SALE — FREE FREIGHT**  
AMERICA'S LOWEST PRICED TOOLS  
PLUS — FREE FREIGHT ON EVERY ITEM

SUPER CORDLESS SPECIALS from BLACK & DECKER		Model	List	Sale
1930	3/8" rev/hi speed		165	110
1950	3/8" High Torque		165	110
5930	Reversible Hammer		179	120
1970	3/8 rev/hi torque screwdriver		179	120
1980	Rev/adj. clutch Scruddrill		179	120

BRAND NEW! SUPER SPECIALS from MILWAUKEE		Model	List	Sale
0214-1	3/8" c/less drive/drill		159	109
8975	H.D. heat Gun, 11.6A		74	49
5920	belt sander 3x24 w/o bag		289	199
5925	belt sander 3x24 w/bag		309	215
5930	belt sander 4x24 w/o bag		299	209
5935	belt sander 4x24 w/bag		319	214

PORTER-CABLE = NEW ITEMS +		Model	List	Sale
655	Drywall Driver 0-4000 Rev		115	85
367	3 1/4" Plane 6.5A		170	115
5009	Mortise & Tenon Jig		50	34
351	3" x 2 1/4" Belt Sander		189	125
352	3" x 2 1/4" Belt Sndr w/bag		199	135
9810	Cordless Screwdr Kit		175	115
320	Abrasice Plane 3A		129	91

ROUTER RIOT by PORTER-CABLE		Model	List	Sale
100	7 7/8 H.P. 6.5 amp		141	98
630	1 H.P. 6.8 amp		150	100
690	1 1/2 H.P. 8 amp		194	130
591	1 1/2 H.P. D-Hdle 8 amp		218	145
536	1 1/2 H.P. Speedmatic		300	190
537	1 1/2 H.P. Speedmatic		315	215
520	3 H.P. Production		460	270
518	3 H.P. Microprocessor 5-sp		490	345

X-TRA SPECIALS MAKITA TOOLS		Model	List	Sale
60100L	C/less Drill w/flashlight-charger & case		162	90
DP3720	3/8 drill Rev. 0-1800 rpm		90	47
65109V	3/8 drill Rev. 0-1500 rpm		116	67
60138R	1/2" Drill rev. 6 amp		174	100
5402A	16" Circular Saw-12amp		468	315
2414	14" Cut Off Saw-13 amp		282	169
36128R	3 HP Plunge Router		286	175
9401	4x24 belt Sander w/bag		248	160

PORTER-CABLE		Model	List	Sale
696	H.D. Shaper Table		150	105
695	H.D. 1 1/2 hp Router/Shaper		278	190
399	Drywall Cut-Out Unit		100	70
	V/Speed Speedtronic Band Saw		450	330
7564	1 1/2" X.H.D. Drill 8 amp		205	145

BOSCH TOOLS		Model	List	Sale
1581VS	Top Handle Jig Saw		225	126
1582VS	Barrel Grip Jig Saw		126	118
1604	1 3/4 H.P. Router		199	118
1942	Heat Gun 650°-900°		99	85
1272	3x24" Belt Sander		259	159

# PORTABLE SAWMILLS

Cut Your Own Lumber  
The Way You  
Want It—  
Without Moving  
The Log

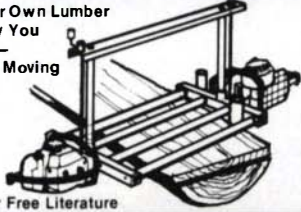

Write for Free Literature

INFORMATION HOTLINE (201) 744-6110



**SPERBER TOOL WORKS**

Box 1224E • W. Caldwell • N.J. • 07007

## Problem Solver Catalog

Over 1,000 Items

Solid Brass Furniture Hardware • Locks  
Casters • Chair Cane • Table Slides  
Hinges • Bed Hardware • Lamp Fittings  
and Much Much More

Write For Your Catalog Today!

**PAXTON HARDWARE**  
LTD.

7818 Bradshaw Road, Dept. FW6  
Upper Falls, MD 21156

Free Mini-Catalog 64 page Catalog \$3.50



Sold through leading distributors. Write  
for complete catalog: Wetzler Clamp  
Co., Inc., Rte. 611, P.O. Box 175, Mt.  
Bethel, PA 18343.

**WETZLER**

THE PROFESSIONALS' CHOICE

**Dupli-Carver**  
Affordable Precision  
Wood Carving  
Machines

Our machines  
let you duplicate  
virtually anything

- Gunstocks
- Signs & Plaques
- Figures & Statues
- Furniture restoration
- Ornate carved  
moldings

For more  
information  
and \$3.99-49  
Dupli-Carver  
Dept. No. 117  
8180 W. 10th St.  
Indianapolis, IN 46224  
(317) 271-1542

3 Models Available

Name \_\_\_\_\_  
Address \_\_\_\_\_  
City \_\_\_\_\_ State \_\_\_\_\_ Zip \_\_\_\_\_

## REPRODUCTION HARDWOODS

for the home craftsman

America's Source for

- Solid Lumber Panels
- Turning Squares
- Plywood
- Butcher Block Stock

All products available in widths  
up to 30" and lengths to 60".  
Squares up to 5" thick.

**RED OAK, MAHOGANY, CHERRY,  
WALNUT, HARD MAPLE, POPLAR**

Stock is defect free, sized ready to use,  
shipped directly to you.

Send \$1.00 for price list  
and product descriptions.

Route 9, Box 214-M, Dept FW  
Morganton, North Carolina 28655  
(704) 433-5490

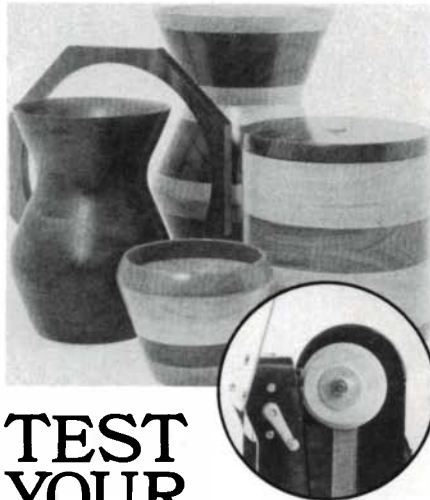
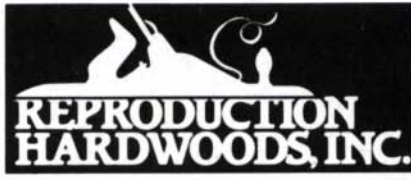

## TEST YOUR IMAGINATION

Create Any Hollow Cylindrical Shape  
up to 12" dia. Cut flat wood into straight or  
angle rings, stack rings, glue, sand, & finish,  
All on your Ring Master.

ORDER YOUR FREE BROCHURE TODAY

1-800-854-9815

In Florida 305/859-2664

We accept  
Master Card, Visa, C.O.D. and  
phone orders

P.O. Box 8527A, Orlando, FL 32856

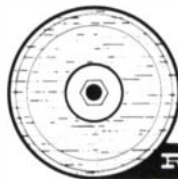

**RING MASTER**

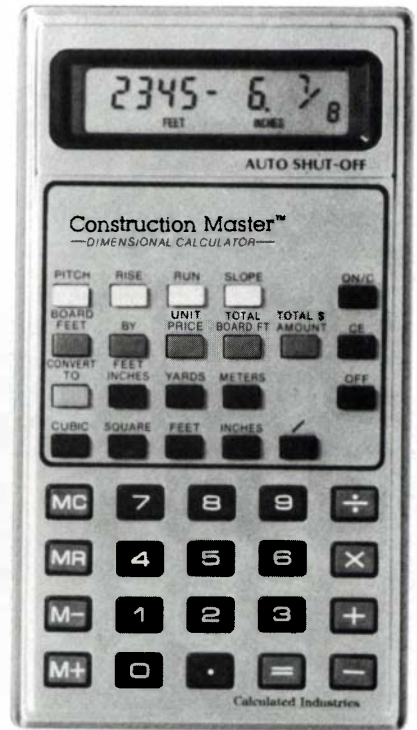

## New Feet-Inch Calculator Solves Building Problems In Seconds

Now you can quickly and easily solve all your dimension problems directly in feet, inches and fractions — with the all new Construction Master calculator.

- Add, subtract, multiply and divide feet-inch-fraction dimensions directly — no conversions needed
- Enter any fraction — 1/2's, 1/4's, 1/8's, 1/16's, 1/32's, 1/64's — even compute problems with mixed fraction bases
- One-button converts between feet-inch-fractions, decimal feet, decimal inches, yards and meters — including square and cubic dimensions
- Custom LCD read-out actually displays the format of your answer — feet, inches, square meters, cubic yards, etc. — including full fractions
- Built-in angle solutions let you solve for right triangles (i.e., roof rafters, squaring-up foundations). Just enter two sides (or a side and a roof pitch) and the calculator instantly gives you your answer — right in feet and inches!
- Board-Feet Mode lets you accurately estimate total board feet and dollar costs for single boards, multiple pieces, or an entire job — in seconds

Plus, the Construction Master is a standard math calculator with memory and battery-saving auto shut-off. Compact (2-3/4x5-1/4x1/4") and lightweight (5 oz.). Includes easy-to-follow instruction manual, 1-year replaceable batteries, full 1-Year Warranty, and vinyl carrying case — with optional leather case also available.

With the time and money you save, the \$99.95 Construction Master will pay for itself many times over — probably on your first job! Order now and save an additional \$10 with our special introductory price of just \$89.95. This offer is limited so don't delay!

Call TOLL FREE 24 Hrs., Everyday

1-800-854-8075

(In Calif., 1-800-231-0546)

(Clip & Mail)

**Calculated Industries, Inc.**  
2010 N. Tustin, Suite B, Orange, CA 92665  
(714) 921-1800

- Please rush me \_\_\_\_\_ CONSTRUCTION MASTER feet-inch calculator(s) at the introductory price of \$89.95 (plus \$3.50 shipping each). Calif. res. add 6% tax.
- Also, include \_\_\_\_\_ custom, fine-grain leather case(s) at \$10 ea. Color:  Brown  Burgundy
- Add my initials hot-stamped in rich gold for \$1 per initial. Imprint the following: [ ] [ ] [ ]
- (Note: Imprinted leather cases are not returnable.)

Name \_\_\_\_\_

Address \_\_\_\_\_

City/State/Zip \_\_\_\_\_

Check enclosed for entire amount of order including 6% tax for California orders.  
 Charge to:  VISA  M/C  Amer. Exp.

Card # \_\_\_\_\_ Exp. Date \_\_\_\_\_

Sign Here \_\_\_\_\_ **FW-2**

**BRATTON MACHINERY IS DELTA INTERNATIONAL HEADQUARTERS**

**BMS Has New Giveaways for Machinery and Power Tools**



**CONTRACTOR SAW**  
Model 34-410 w/62-042, 1 1/2 HP Motor  
**SALE: \$699\*** FRT PD  
Less Delta Rebate: **\$599\*** NET PD

**DRILL PRESS**  
Model 17-900, 16 1/2 in., 2 Speeds, 3/4 HP, 3/8 in. Chuck. Tilt Table, Two Year Warranty, List: \$375\*  
**SALE: \$299\*** FRT PD

**PLANER** **SALE:**  
Stand Optional **\$999\*** FRT PD  
Model 22-651

Buy all three and receive FREE eight piece Lathe Tool Set with wood box.



**DELTA ELECTRONIC SCROLL SAW**  
Model 40601  
18" throat  
**\$849.00\*** FRT PD

**DELTA MACHINERY**

34763-Unisaw, 10" table saw,	SALE	1669.*
43375-Shaper, 2 spd, 1ph 3hp		1849.**
31730-Belt/Disc Sander with R5261 mtr/std		1275.*
37315-Jointer, 8", with R49054 mtr/std		1475.*
33150-Sawbuck		499.*
43122-Shaper, light duty, 1ph 1hp		489.*
37223-Jointer, 6", w/ std & mtr		949.*
28243-Bandsaw, 14" open std. 1/2hp mtr		535.*

20% OFF ON DELTA ACCESSORIES Freight Paid

\*FREE AM/FM Clock Radio/Telephone and Free Freight  
\*\*FREE Wedge & Groove Shaper Cutters—\$225 Value

**Power & Machine Tools Specials**

**Bratton Has New Giveaways from Router Bits to Sandpaper**

PORTER-CABLE	HITACHI	RYOBI
330 Finish Sander	TR12 Router 3hp	R-500 Router 3hp
260 Belt Sander	SB8T Bit Sander 3 x 24	TS251U Miter Saw 10"
362 Belt Sander	CJ65VA Orbital Jig Saw	AH115 Pln/Jointer
505 Finish Sander	F1000A Pln/Jointer	AP125 Planer 12"
518 Speedtronic, 3hp	P100F Planer	AP10 Planer 10"
536 Router, 1 1/2hp	B600A Resaw	BS360NRR Resaw
537 Router, 1 1/2hp		BS50N Resaw
690 Router, 1 1/2hp		
691 Router, 1 1/2hp D-Hd		
695 Router Shaper		

\*Comes with 25 Sheets of Sandpaper (100G or 150G) \$6 Value  
\*\*Comes with 10 Belts (80G, 100G, or 120G) \$12 Value  
\*\*\*Comes with 8 Router Bits, 1/2 Shank; Cove, Rounding, Half Round, Roman Ogee, V Grooving, Beading, (2) Mortising; \$170 Value

**Bratton International Machinery THE BEST FROM THE FAR EAST**

BMS100 10 In. Table Saw, mag cont.	SALE	999.**
BMS200 8 In. Jointer, 1ph 1.5hp, mag cont.		749.**
BMS201 12 In. Jointer, 1ph 3hp, mag cont.		1799.*
BMS302 20 In. Planer, 1ph 5hp, 3hp 5hp, mag		2149.*
BMS303 24 In. Planer, 3hp 7.5hp mag cont.		3695.*
BMS308 15 In. Planer, 1ph 3hp, mag cont.		899.*
BMS310 18 In. Planer, 1ph 5hp mag cont.		1899.*
BMS400 2 Speed Shaper, 1ph 2.5hp mag controls, rev.		1099.*
BMS401 Spindle Shaper, 3 speed 3hp 1ph, mags		1999.*
BMS502 Dust Collector, 2hp.		395.**
BMS600 14 In. Bandsaw, 3/4hp, encl. std.		350.**
BMS601 18 In. Bandsaw, 2hp open stand		699.**

Buy Two Machines and Get Eight Piece Lathe Tool Set with Wood Box

\*FREE Television  
\*\*FREE Radio/Clock/Telephone Freight Prepaid/Lower Prices for Pickup in Tallahassee/One Year Warranty

Get Our "NEW" Catalog with Every Purchase or Send \$3 for Catalog

**FREE FREIGHT — POWERMATIC —**

66 Table Saw w/ Biesemeyer	SALE	1775. Frt Pd*
26 Shaper		1750. Frt Pd**
60 Jointer		1399. Frt Pd*
180 Planer, 1ph 5hp, NO KRG		4599. Frt Pd*
81 Bandsaw		2599. Frt Pd*

\*FREE 8 Piece Lathe Tool Set with Wood Box  
\*\*FREE Ogee Shaper Cutter— \$115 VALUE



BMS200 8 In. Jointer, 1ph 1.5hp, mag cont. SALE 749.\*\*

**We Discount and Honor ALL freud SPECIALS**

**BRATTON MACHINERY & SUPPLY**  
1015 Commercial St. Box 20408FW Tallahassee, FL 32316  
Nat Wats 1-800-874-8160  
FL Wats 1-800-342-2641, 904-222-4842  
VISA/MasterCard (subject to 3% surcharge)

**LEASE PURCHASE PLANS WITH TAX CREDITS AVAILABLE**

**HARPSICHORDS & FORTEPIANOS**

Build it yourself from one of our kits or let our experienced craftsmen build it for you.

Three Centuries of Harpsichord Making by Frank Hubbard (\$30 postpaid)

For brochure send \$1.00 to **HUBBARD HARPSICHORDS INCORPORATED** 144-W Moody Street, Waltham, MA 02154 (617) 894-3238

**CABINET MAKERS!** **ITS NEW!**

Save time **Comput-o-disc** automatic cut list

EUROPEAN DESIGN KITCHEN

DIAL YOUR SIZE & CUT LIST APPEARS AUTOMATICALLY

ONLY \$12.95 introductory offer

make extra profit!

- 5 MINUTE CUT LIST
- SAVE DAYS PER JOB
- EXACT SIZES

**Comput-o-disc**  
P.O. Box 292421  
Ft. Laud., Fla. 33329

**Wood Products from The Victorian Age**

Over 350 mouldings, headblocks, baseblocks, casings and wainscot of authentic Victorian designs are illustrated in our 32 page catalog.

For Catalog and Price Sheet send \$3.00 to:

**SILVERTON VICTORIAN MILL WORKS**  
Box 850-13  
Silverton, CO 81433  
303-387-5716

**PROTECT YOUR EYES**

- Designed for craftsmen
- Goggle-like fit
- Ratchet hinge ensures perfect fit
- Exceptional Style
- One size fits all
- All side protection
- Comfortable
- Exceeds Z87.1 and CSA standards
- Made in U.S.A.
- Thoughtful gift

**\$9.95 Delivered**

Money back guarantee - You must be pleased Check, Money Order, Mastercard, Visa

Write us for a free Head to Toe Safety Catalog

**KENCO SAFETY PRODUCTS DIV**  
78 Glasco Turnpike P.O. Box 385 Woodstock, N.Y. 12498  
IN NY STATE (914) 679-5246 OUT OF STATE 1-800-341-4103

## BOSCH Power Tools

Jig saws  
only \$135.00



Model 1581VS

NO.	TOOL	SALE
1582VS	Orbit. Action Mob Hdle Jig Saw	\$128.00
3238VS	Unv. Shank Mult. Orbit. Jig Saw	83.00
1601	1 hp Router	104.00
1602	1½ hp Router	129.00
1604	1¾ hp Router	146.00
1606	D-Handle, 1¾ hp Router	163.00
90300	Fixed Base Router, ¾ hp	350.00
90303	Plunge Base Router, ¾ hp	472.50
90085	¾ hp Router	91.00
32700	3x21 Dustless Belt Sander	122.00
1272	3"x24" Belt Sander	159.00
1272D	3"x24" Belt Sander w/Dust Collector	169.00
1273	4"x24" Belt Sander	169.00
1273D	4"x24" Belt Sander w/Dust Collector	179.00
1921VSRK	3/8" Ver. Spd. Screwdriver	\$129.00
1920VSRK	3/8" Cordless Reversing Drill	99.00
1920RK	3/8" Cordless Reversing Drill	85.00
3268	Heat Gun	48.00
1158VSR	3/8" Ver. Spd. Rev. Drill	54.00
1651	New Bosch 7¼" Cir. Saw, 13 amp	89.00

CALL TOLL FREE 1-800-525-0750  
In Colorado 1-800-523-6285  
Denver 355-2391

AVIATION/INDUSTRIAL SUPPLY  
P.O. Box 39159 • Denver, CO 80238  
TOOLS FREIGHT PAID

My Ebac  
LD82  
paid for itself in  
just 3 months!

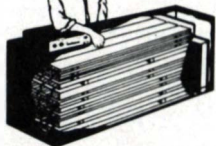

## YES YOU CAN KILN DRY YOUR OWN LUMBER...

...As little as 100 BF per month for pennies a board foot!  
Let EBAC, the World Leader, show you how with an...

### EBAC LD82 WOOD DRYING KILN

- Simple to operate — plug it in and turn it on!
- Dry lumber — 6%-8% — when you need it!
- Increase your profits — buy green wood & dry it yourself!
- Quiet and efficient — your TV probably uses more electricity!
- Rapid payback — usually within 1-6 months!

What are you waiting for? For less than \$1,300, you could be kiln drying your own lumber and pocketing the kiln dried premium! Find out why 450 of your friends in the U.S. and Canada — most with no wood drying experience — own EBAC DRY KILNS. GET THE FACTS — CALL EBAC, or write, for more information and a no obligation lumber drying proposal. — YOU'LL BE GLAD YOU DID!



**EBAC LUMBER DRYERS**  
8726 E. 33rd St., Dept. F., Indianapolis, IN 46226  
317-897-2100 / 1-800-433-9011

— LARGER SYSTEMS AVAILABLE —

# 1,010 good reasons why you should use DML cutting tools

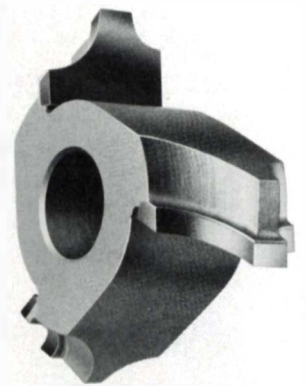
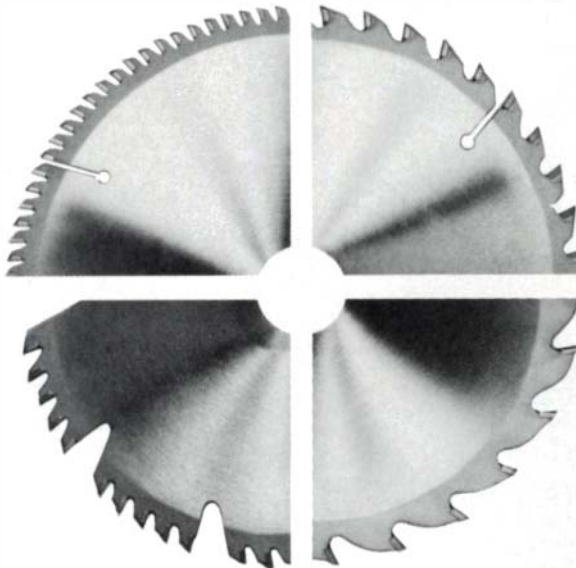

### 1 through 1,002: The tools themselves

When you choose DML saws, router bits, and shaper cutters, you've selected an almost unbelievable line of 1,002 different cutting tools, each engineered for a specific cutting task. Crosscutting. Ripping. Trimming. General purpose. Combination cutting. Routing. Molding. Shaping. For solid wood. Plywood. Hardboard. Asbestos wallboard. Plastics. Nonferrous metals. And more. Carbide tipped or high speed steel. Virtually any cutting tool you could need. For virtually any portable or fixed equipment you could run.

### 1,003: Industrial quality

You'll be using the best in American workmanship. Each DML tool is crafted with the utmost care — and with the most current equipment — from top grade tool steel. Precision balanced, finished to industrial standards. And diamond honed to specific designs based on the ultimate intended cutting purposes. DML doesn't settle for less. Neither should you.

### 1,004 through 1,010: New tools

DML's entire line of cutting tools is constantly expanding. Recent additions include Radi-All® and Miter-All™; abrasive blades and other new products are now in development. DML also offers you the ability to design and manufacture custom tooling to meet specific needs.

For diversity of selection, for industrial quality, for custom-tool capabilities...DML. The only reasonable choice.

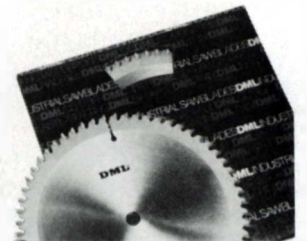

**DML**  
Cutting everything but corners

A SUBSIDIARY OF VERMONT AMERICAN CORPORATION

For more information about DML's complete line of cutting tools, fill out and mail to:

DML, Inc.  
1350 S. 15th Street  
Louisville, KY 40210

Dept. FW

NAME \_\_\_\_\_

ADDRESS \_\_\_\_\_

CITY \_\_\_\_\_ STATE \_\_\_\_\_ ZIP \_\_\_\_\_

# DELTA 10" Contractor's Saw \$100 Rebate

## 34-410A CONTRACTOR SAW

• Large 40" x 27" table with extension wings • 24" rip capacity R or L of blade • Lifetime-lubricated ball bearing construction • Jet Lock self-aligning rip fence • See-thru blade guard • Up-front controls • UL listed

Retail ..... \$1,073  
Our Price ..... \$679  
Rebate ..... \$100

Your Final Cost **\$579**



**FREE FREIGHT**

OFFER EXPIRES JUNE 30  
\$55.70 Carbide Dado and insert \$30 with saw

### FULL LINE DELTA DISTRIBUTOR

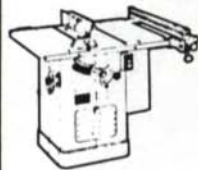

**UNISAW**  
Call for competitive Pricing

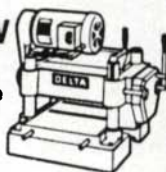

22-651  
13" Planer  
**\$999**

\$114.30 Replacement blades \$60 w/planer. Ask for Special Stand Prices.

46-541S  
**12" LATHE**  
**\$1389**



INCLUDES: Super chuck, 8 piece turning tool set, & 2 instruction books.

40-601  
**18" SCROLL SAW**  
**\$899**



50-180  
**Dust Collector**  
**\$399** LESS 55 GAL. DRUM  
2 H.P. AVAILABLE

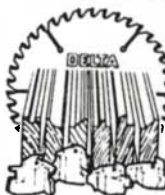

**BLADES & CUTTERS**  
UP TO  
**50% OFF**

FACTORY AUTHORIZED SERVICE

### FULL LINE DISTRIBUTORS OF:

**BIESEMEYER**

**BLACK & DECKER**

**BOSCH**

**DELTA**

**FREEBORN**



"Jorgensen"

**Makita**

**Milwaukee**

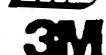

**PORTER-CABLE**



**POWERMATIC**

**a c m e**

*Electric*

**TOOL CRIB OF THE NORTH SINCE 1948**

LIMITED TIME OFFER FREE FREIGHT

CALL TOLL FREE FOR MIKE

**1-800-358-3096**



# NOW! REDUCE THE RISK AT YOUR TABLE SAW (OR ANY OTHER MACHINE)

SUPPORT YOUR WORK  
PIECE AT ALL TIMES



## ROLLER TABLE

Rock Solid Support

- adjustable
- portable
- use at any machine



PEDESTAL ROLLER

OUTFEED ROLLER

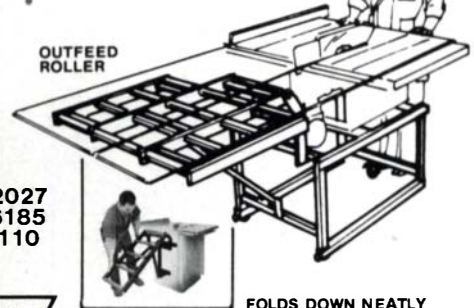

FOLDS DOWN NEATLY

CALL TODAY FOR FREE CATALOG

(800) 624-2027  
(313) 399-6185  
EXT. 110



INNOVATIVE SHOP SOLUTIONS

HTC PRODUCTS, INC., 120 E. HUDSON, ROYAL OAK, MI 48067

# the American Woodworker

— WOODWORKERS —  
Look at the partial list of projects and articles that were published in our last four issues. It is by no means a complete list, but serves as a sample to show you we are a magazine balanced between projects and articles. These are in addition to our six regular feature departments that are in every issue. Check below; you can subscribe for only \$12.00.

### ARTICLES

- The Basics of Steam Bending
- Your First Selling Show
- Woodturning: Developing The Design
- Tips for Successful Handcut Dovetails
- Improving The Quality Of Routed Edges
- Stationary Power Tools
- Setting Jointer Knives
- Carcase Construction
- The Wedged Through Tenon
- The Scraper
- Jointer Knife Setting Gauge
- Commonsense Tool Maintenance
- The Art Of Mother-of-Pearl Inlay
- Picture Frames
- Dust Collection System
- Sam Maloof's Finish
- The Finishing Room
- Router Fixture Design
- Shop Safety
- Woodworking Associations

### PROJECTS

- Small Cherry Drop-Leaf Table
- Dovetail Clocks
- A Plantation Desk
- The Birth Of A Whale Cradle
- High Backed Settle
- Bench-Coffee Table
- Fireplace Bench
- Oak Wash Stand
- Small Tilt-Top Table
- Dry Sink Hutch
- Band Saw Boxes
- Variable Jig For Cutting Tapers
- Happlewhite End Tables
- Chippendale Lowboy
- Dutch Cupboard
- Traditional Chest
- Lap Desk
- Walnut Foot Stool
- Eli Terry Pillar And Scroll Clock
- Tenoning Jig

No matter what level of expertise or interest you have in woodworking, we have something that you will enjoy in every issue. Published quarterly, The American Woodworker is printed oversized (9" x 12") on heavier than usual paper. It is a "collector's type" publication you will want to keep for years to come. Subscribe today for only \$12.00 per year or \$22.00 for two years. (Foreign: \$16.00 for one year, \$26.00 for two years, U.S. funds only.) 100% guaranteed or money refunded on unmailed copies. Subscribe today!

The American Woodworker  
P.O. Box 1408, Dept. FW-8  
Hendersonville, TN 37077-1408  
(615) 822-0857

# The Router Bit System Carbide Tipped



1/2" Shank

3-7/8" Diameter

**P**roduce raised  
panel doors at a price  
you can afford.

The Panel Crafter System consists of two matched router cutters that produce stiles and rails and a third cutter that produces the raised panel. Send for our full catalog of Carbide Router Bits and Shaper Cutters.

MANUFACTURED BY:

**RELIABLE GRINDING**

145 W. Hillcrest Ave., San Bernardino, CA 92408  
(800) 424-9154, within Calif. call (800) 521-8521  
(714) 884-7258



DEALER INQUIRIES INVITED

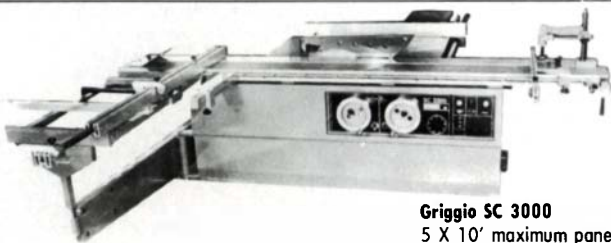

**Griggio SC 3000**  
5 X 10' maximum panel  
Will accept up to  
16" blade (with scoring)

## Trouble cutting large panels or components accurately?

We've got the answer at an unbelievably  
low price.

Woodshop Specialties is a stocking distributor for POWERMATIC, DELTA (formerly Rockwell International) and a full line of other quality stationary woodworking machinery. We also sell parts, deal in reconditioned machinery, and fully service every machine we sell.

When you want complete satisfaction, write or call and ask for owner Mike Shaban.



**WOODSHOP SPECIALTIES**

Cold River Industrial Park • Quality Lane P.O. Box 70  
Rutland, Vermont 05701 • 802-773-3240

**PRO TOOLS INC.** CALL TOLL FREE  
1218 E. Katella (800) 445-TOOL (Outside CA)  
Anaheim, CA 92805 (800) 842-TOOL (Inside CA)

*Largest Power Tool & Accessory House  
On The West Coast*

Freight Prepaid on Orders of \$50.00 or More  
in Continental U.S.A. Errors subject to correction.

### SENCO Nailers & Staplers

K Stapler Narrow Crown	239.50
Senclamp For Miter Joints	329.50
LS II 1" Pin Nailer	249.00
SN I 1 1/2" Finish Nailer	254.00
SFN II B 2 1/2" Finish Nailer	389.00
1/4" H.P. Mini Air Comp	249.00

### FORSTNER BITS Made in W. Germany (Arco)

2120 4 pc. Set (1/4, 3/8, 1)	27.00
2119 Compl. Set (1/4 to 1 1/2)	75.00
All Bits Sold Separately	
Biesemeyer 50" Rip Fence	299.00
Dowl/It Model 1000	24.95
Model 2000	34.95
Ryobi Plunge Router and Freud	
15 pc. Router Bit Set	219.95
15 pc. Router Bit Set	139.95

### BOSCH

1158VSR 3/8" VSR Drill	59.00
1581VS Electronic Jigsaw	129.00
1601 1 hp Router	79.00
1604 1 1/4 hp Router	115.00
1920VSRK Cordless Drill	89.00
1921VSRK Cordless Screwdriver	109.00
1272 3 x 24 Belt Sander	159.00
1272D 3 x 24 Belt Sdr. w/Bag	169.00
1273 4 x 24 Belt Sander	169.00
1273D 4 x 24 Belt Sdr. w/Bag	179.00

### HITACHI

DRL10K 3/8" Cless Driver Drill w/case	93.00
TR6 Laminate Trimmer	89.00
TR12 3 hp Plunge Router Kit	169.00
C10FA 10" Miter Saw Kit	269.00
D13V 1/2" VSR Drill	89.50
D10V 3/8" VSR Drill	69.50
W6V 0-4000 Drywall Screwgun	69.00
CR10V VS Orbital Recipro Saw	119.00
C6DA 6 1/2" Cordless Circ. Saw	129.00

### LEIGH

T0514 12" Dovetail Jig, through	136.50
T0514L 24" Dovetail Jig, through	209.50
D1258-12 12" Dovetail Jig, 1/2 blind & through	262.00
D1258-24 24" Dovetail Jig, 1/2 blind & through	339.75

### MILWAUKEE

6539-1 Cordless Screwdriver	59.95
0210-1 3/8" Cless Driver Drill	112.00
6305 6 1/2" Cless Circ. Saw	139.00
0234-1 1/2" Mag Drill	114.00
0228-1 3/8" VSR Drill	94.00
5935 4 x 24 Belt Sander	214.95
6014 1/2 Sheet Sander	114.00
6365 7 1/4" Circular Saw	109.00
6255 Top handle Jigsaw	140.00
6507 Variable Speed Sawzall	124.75
6511 Two speed Sawzall	122.75

### SKIL

551 5 1/2" Circular Saw	74.00
367 6 1/2" Worm Drive	138.00
77 7 1/4" Worm Drive	138.00
825 8 1/4" Worm Drive	169.00
2016-2 3/8" Cless Drill Kit	98.00

### MAKITA

6010SOW 3/8" Cordless Drill	48.00
6012HDW 3/8" Cless S' Driver	99.00
DA3000W 3/8" RA Cless Drill	99.95
DA3000R 3/8" RA Drill	104.00
5081DW 4" Cordless Saw	104.00
804510 Finish Sander	44.00
804530 Finish Sander	49.00
43018V Jigsaw	129.00
4200N 4 1/4" Circular Saw	93.00
19008W Planer	94.00
1100 Planer	184.00
OP3720 3/8" VSR Drill	49.00
9501B Kit 4" Sander/Grinder	59.00
8510LVR 3/8" HD VSR Drill	89.00
38088R Router Kit	89.00
2708 8" Table Saw	219.00
5402A 16" Beam Saw	349.00
9030 1" Belt Sander	129.00
99008 3 x 21 Belt Sdr. w/Bag	123.00
99248 3 x 24 Belt Sander	134.00
992408 3 x 24 Belt Sdr. w/Bag	139.00
Pony #50 3/4" Bar Clamps	8.50 ea.
Occidental Bag Set: Sm. Med. Lg	89.00

### SANDING BELT SPECIALS

Grits 40, 50, 60, 80, 100, 120:	
3 x 21 pkg. of 10	8.00
3 x 24 pkg. of 10	9.00
4 x 24 pkg. of 10	10.00
Belt Cleaning Stick	5.00

### RYOBI

AP-10 10" Surface Planer	399.00
TS2514 10" Miter Saw w/Free	
10" LU85M010	219.95
Finish Sander	39.00
S500A 16" Beam Saw	287.00
W200S 14" Miter Saw	399.00

### ROCKWELL

40-500 Scroll Saw	89.50
28-180 10" Band Saw	129.00
23-880 6" Bench Grinder	54.00
23-880 8" Bench Grinder	89.00
11-950 8" Bench Drill Press	109.00
31-352 1" Sander/Grinder	199.00

WE HAVE 100% OF LINES—1000% OF ITEMS—IN  
STOCK!—ALL ORDERS SHIPPED WITHIN 24 HOURS—  
CHECK, MONEY ORDER, VISA, MASTERCARD  
CAL RESIDENTS—ADD 6% SALES TAX

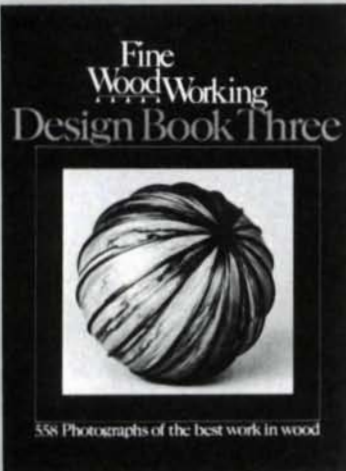

## A decade of inspiration in wood

Three times in the past ten years we've invited readers to send us pictures of their best works in wood. Some 40,000 photos in all have been submitted, most of them superb examples of the woodworker's art. The best are collected in our *Design Books*.

**Design Book Three:** The newest of our *Design Books* offers an inspiring collection of beautifully made toys, beds, cabinets, sculptures and more. Some of the pieces are traditional, most are contemporary—each was selected for its beauty, craftsmanship and individuality. This volume also features a 24-page worldwide Directory of Woodworkers. *216 pages, \$13.95 postpaid Publication #25*

**Design Book Two:** This second volume in our series is a lavish treasury of 1,150 photographs, chosen from among the thousands submitted by our readers in 1979. *288 pages, \$13.95 postpaid Publication #08*

**Biennial Design Book:** Chosen from over 8000 photos sent to our editors in 1977, the striking designs collected in this first volume are sure to send you back to the shop with a wealth of new ideas. *176 pages, \$11.95 postpaid Publication #02*

To order: Please use the insert after page 18 or call toll-free, 1-800-243-7252, and use your credit card.

### THE PHOENIX CLOCK

An Artistically Sculptured Wooden Grandfather Clock Kit

- Compare the artistry and beauty of the Phoenix Clock against similar works.
- An adult kit of unequalled quality and workmanship.
- Machined to tolerance customary in precision metalworking.
- Premium solid and laminated hard maple for dimensional stability and durability.
- All finishing materials supplied to guarantee excellent results.
- All the adjustments found in the finest brass clocks.
- Brackets available for wall mounting or to adapt to several manufacturer's case kits.
- Serial numbers add value for collectors.
- Complete instructions, no previous experience needed, jigs furnished to aid in building and adjustment.



See also p. 23 March 84, p. 93 July 85 and p. 89 Jan. 85 adn. Send \$2.00 for Color Literature NOTE CHANGE OF ADDRESS

#### KASSNER WOODCRAFT, INC.

P.O. Box, 1878  
2700 31st Street  
Tuscaloosa, Ala. 35403  
(205) 752-8153



### Turning into a better craftsman can be as simple as turning the pages of our new catalog.

Our new 244 page catalog is filled not just with pictures of great hand and power tools, but carefully written specs, detailed illustrations and recommendations from craftsmen who've spent much of their lives making, using and testing tools.

You'll know what they look and feel like, and you'll know how they fit your needs.

We believe you're not the average craftsman. So why should we give you an average catalog?



Garrett Wade Co., Dept 115  
161 Ave. of Americas, N.Y., N.Y 10013  
Please send me your 244 page catalog of wood working tools, machinery and accessories. Enclosed \$3.00.

Name \_\_\_\_\_  
Address \_\_\_\_\_  
City \_\_\_\_\_  
State \_\_\_\_\_ Zip \_\_\_\_\_

**LEADER 460**  
PDMTRAS  
**PNEUMATIC PIN ROUTER**

PREPAID PRICE **\$625.00**  
Texas Residents Add 6% Sales Tax

- DOES THE WORK OF TOOLS COSTING TWICE AS MUCH
- UNLIMITED VERSATILITY
- THREE ADJUSTABLE DEPTH STOPS
- LARGE 24X30" WORK SURFACE

Please Call or Write For Information.

**DALLAS WOOD AND TOOL STORE**  
1936 RECORD CROSSING 214 631-5478 DALLAS, TEXAS 75235

### NATIVE AMERICAN HARDWOODS

WALNUT, BUTTERNUT, CHERRY  
CURLY & BIRD'S-EYE MAPLE  
Most Other Domestic Woods

- EXTRA WIDE/EXTRA THICK STOCK
- TURNING SQUARES/BLOCKS
- QUARTERSAWN/BOOKMATCHED LUMBER
- SPALTED LUMBER/BLOCKS
- THIN STOCK NO MINIMUM
- FLOORING/PANELING WHOLESALE & RETAIL

Comprehensive Listing—One Dollar (Refundable)

**NATIVE AMERICAN HARDWOODS LTD.**  
R1, W. VALLEY, N.Y. 14171 • (716) 942-6631

Distinguish Your Fine Workmanship  
With Your Own, Personal

## BRANDING IRON

For Hard and Soft Wood

Available with your:

- \* Initials \* Name—w/wo Address
- \* Logo \* Choice of Wording

Changeable date available for most units  
Call or write for free brochure

FAST SERVICE IS OUR SPECIALTY  
**NOVA TOOL CO.**

4533 Colfax Circle, Dept. FW  
P.O. Box 29341, Lincoln, NE 68529  
(402) 464-0511



GUARANTEED

## WOOD REPAIR

Durham's Rock Hard Water Putty makes lasting repairs in wood. Won't shrink or fall out. Sets quickly, holds tight and can easily be painted. Economical, easy to use. Available at lumber, paint and hardware stores.

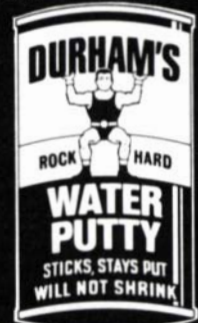

**DONALD DURHAM COMPANY**  
Box 804-FW • Des Moines, IA 50304



# TREND-LINES BEATS ANY AD THIS ISSUE!

## MAKITA TOOLS

1100	3 1/4" Planer Kit	\$ 169.95
1805B	6 1/8" Planer Kit	277.95
19008W	3 1/4" Planer w/case	99.95
2030N	12 1/2" Plnr/Jntr	1445.00
2040	15 5/8" Planer	1235.00
2708W	Table Saw W/Carbide Blade	221.95
3601B	Router	119.95
3612BR	3 HP Router	185.95
4200N	4 3/8" Circular Saw	96.95
4300DW	Cordless Jig Saw	108.95
4301BV	Vr. Sp. Orbital Jig Saw	124.95
5007NB	7 1/4" Circular Saw	99.95
5008NB	8 1/4" Circ. Saw	109.95
50810DW	3 3/8" Cordless Saw	109.95

5402A	16" Circular Saw	314.95
6000R	Uni-Drill	99.95
6010DL	Cordless Drill w/charger light & case	99.95
6010DWK	Cordless Drill w/charger & case	88.95
6010SDW	3/8" Rev. Cordless Drill	49.95
6012HDW	Cordless Drill Kit 2 Sp.	108.95
6510LVR	3/8" Drill—Rev.	84.95
6710DW	Cordless Screwdriver	104.95
6800DBV	Drywall Screwdriver	89.95
9045B	Finishing Sander	99.95
9045N	Dustless Sander	99.95
9207SPB	7" Sander Polisher	139.95
9401	4" x 24" Belt Sndr	162.95
98202	Blade Sharpener	169.95
9900B	3" x 21" Belt Sndr	122.95
9924DB	3" x 24" Belt Sndr	134.95
BO4510	Finishing Sander	49.95
DA3000DW	Cordless Angle Drill	102.45
DA3000R	3/8" VSR Angle Drill	99.95
DP3720	3/8" Reversible Drill	49.95
DP4700	Drill Reversible	99.95
GV5000	Disc Sander	56.95
JR3000V	Recipro Saw	124.95
JV2000	Orbtl. Var. Jig Saw	104.50
LS1000	10" Miter Saw w/vise	229.95

## AEG TOOLS

BSPE60	Orbtl. Top Handle Jig Saw	\$127.95
EH82S	3 1/4" Planer	129.95
EZ501	Cordless Screwdrvr	39.95
EZ502	Cordless Driver w/adj. handle	51.95
EZ505	Cordless Drill/Driver	78.95
FSP60	Orbital Jig Saw	99.95
HBSE75S	3" x 21" Belt Sndr	118.95
PC70	7 1/4" Circular Saw	93.95
RSK600	Orb. Recip. Saw	136.95
SBE401RL	3/8" Hammer Drill	52.95
SCRIIE	Electronic Drywall Driver	74.95
VS130	1/3 Sheet Orbtl. Sander	48.95
VS260	1/2 Sheet Orbtl. Sander	88.95
VSS260	1/2 Sheet Drbtl Sander w/dustbag, rubber sanding plate	118.95

## JORGENSEN BAR CLAMPS (HEAVY DUTY)

No.	Size	Each	Pkg. 6
No. 7224	24"	17.30	15.70 Ea.
No. 7230	30"	18.10	16.45 Ea.
No. 7236	36"	18.70	16.95 Ea.
No. 7248	48"	20.75	18.70 Ea.
No. 7260	60"	22.65	20.55 Ea.
No. 7272	72"	24.55	22.25 Ea.

## JORGENSEN CLAMPS (MED. DUTY)

No. 3712	12"	5.90	5.35 Ea.
No. 3724	24"	7.30	6.60 Ea.
No. 3730	30"	8.20	7.40 Ea.
No. 3736	36"	8.85	7.95 Ea.

## JORGENSEN HAND SCREWS

No. 3/0	3"	8.45	7.60 Ea.
No. 0	4 1/2"	9.90	8.90 Ea.
No. 1	6"	11.30	10.15 Ea.
No. 2	8 1/2"	13.45	12.15 Ea.

## JORGENSEN BAR CLAMPS

No. 4512	12"Open	17.45	15.70 Ea.
No. 4524	24"Open	20.85	18.85 Ea.
No. 4530	30"Open	21.90	19.65 Ea.
No. 4536	36"Open	22.90	20.60 Ea.

## RYOBI TOOLS

AH115	12 1/2" Plnr-Jntr	\$1275.00
AP125	12 1/2" Planer	995.00
AP10	10" Planer	399.95
B7075	3" x 21" Belt Sndr	117.95
BS360NR	Hvy Dty Band Saw	1195.00
BS50N	9 1/4" Band Saw	695.00
JSE-60	Electronic Jigsaw	124.95
L-580	6 1/8" Planer	253.95
R-330	2 HP Router	139.95
R-500	3 HP Plunge Router	162.45
R2500	10" Radial Arm Saw	445.00
RA2500SP	Radial Arm Saw/Kit	525.00
TS-251UB	10" Miter Saw w/ Freud LU85M10 Blade	229.00

## MILWAUKEE TOOLS

0228-1	3/8" VSR Drill	\$ 93.95
0234-1	1/2" VSR Drill	113.95
0375-1	3/8" Rev. Angle Drill	117.95
1107-1	1/2" VSR D Handle	144.95
5660	1 1/2 HP Router	189.95
5680	2 HP Router	219.75
5935	4" x 24" Belt Sndr	214.90
6014	1/2 Sheet Sander	124.95
6255	Vr. Sp. Jigsaw	139.95
6287	H.D. Jigsaw	224.50
6305	6 1/4" Cordless Saw	134.95
6367	7 1/4" Circ. Saw	129.95
6507	Sawzall w/case	139.95
6539-1	Cordless Screwdriver	61.95
6543-1	1/4" Screwdriver	155.50
6749-1	Magnum Screwdriver	139.95
8975	Heat Gun w/scrapers	89.95

## DELTA (ROCKWELL) POWER TOOLS

11-072	32" Radial Drill	\$ 444.95
22-651	13" Planer	999.00
28-243	14" Band Saw	563.90
28-283	3/4 HP Bandsaw	745.00
31-730C	Belt and Disc Sander	1281.00
33-150	Sawbuck	529.00
33-990	10" Radial Arm Saw	474.50
34-410	10" Contractors Saw	699.00
34-761	Unisaw	1450.00
37-220C	6" Jointer	1250.00
37-255	6" Jointer	495.00
37-315C	8" Long-Bed Jointr	1495.00
40-601	Electronic Scroll Saw	895.00
43-122	Wood Shaper	528.95
46-140	11" Lathe	433.95
46-541S	12" Lathe	1399.00

All Prices Include Genuine Delta Motors

## PORTER CABLE

100	7/8 HP Router	\$ 97.95
303	6" Disc Sander	153.95
309	Laminate Trimmer	90.95
314	4 1/2" Trim Saw	124.95
320	Abrasive Planer	90.95
330	Palm Finish Sander	61.95
337	3" x 21" Belt Sander w/bag	133.95
360	3" x 24" Belt Sander w/bag	196.95
362	4" x 24" Belt Sander w/bag	206.95
505	Finishing Sander	122.95
518	3 HP Electronic Router	343.95
587	7 1/4" Circular Saw	139.95
690	1 1/2 HP Router	135.95
695	1 1/2 HP Router/Shaper	194.95
696	Router/Shaper Table only	104.95
3151	7 1/4" Circular Saw	116.95
7548	Orb. Jig Saw	139.95
7648	Orb. Jig Saw w/barrel grip	139.95
9627	2 Sp. Tiger Saw Kit	135.95

## PONY CLAMP FIXTURES

No.	Size	Each	Pkg 6
No. 50	3/4" Pipe Clamp	7.30	6.55 Ea.
No. 52	1/2" Pipe Clamp	6.05	5.60 Ea.
No. 1215	(WEB) 15"	6.80	6.35 Ea.
No. 7456	Clamp Pads	2.95	2.50 Ea.

## JORGENSEN & PONY CLAMPS

No. 3325	3 Way Edging	5.75	5.10 Ea.
No. 1623	3" Hold Down	7.50	6.30 Ea.
No. 3202HT	2" Spring	2.15	1.90 Ea.

**We Honor All Freud Specials**



Free Wooden Case

## New! Freud Tool Sets

TFWC104	4 Pc. Chisel Sets	\$19.95
TFWC106	6 Pc. Chisel Sets	31.75
TFWC110	10 Pc. Chisel Sets	52.95
TFTT108	8 Pc. Lathe Set	53.95
TFCS106	6 Pc. Carving Set	59.50
TFCS112	12 Pc. Carving Set	111.50

## BLACK AND DECKER INDUSTRIAL TOOLS

1179	3/8" Var. Sp. Drill	\$ 69.95
1575	3/8" VSR Scruddrill®	99.95
1703	10" Miter Saw	199.95
3051	7 1/4" Wormdriver Saw	139.95
3103	2 sp. Cut Saw kit	99.95
3105	Var. Sp. Cut Saw kit	109.95
3107	Var. Sp. Orbital Cut	129.25
3265	Laminate Trimmer	145.65
3310	1 1/2 HP Router	129.95
3370-10	3 1/4" Planer	99.95
4010	Palm Sander	49.95
4247	4 1/2" Disc Sander/Grinder	69.95
6750	Heat Gun	59.95
9425	Compound Miter Saw	119.95

## HITACHI TOOLS

CB75F	14 1/2" Band Saw	\$1517.80
CJ65VA	Electronic Jigsaw	157.95
CR10V	Reciprocating Saw	123.95
C6DA	6 1/4" Circular Saw	134.95
C12Y	12" Table Saw	1307.25
DRC-10	Cordless Screwdriver	94.45
F1000A	Planer/Jointer	1338.75
F2DA	3 1/4" Planer	102.85
P50	6 5/8" Planer	283.45
P100F	12" Planer	1013.25
SB-75	3" x 21" Belt Sander 2 sp. w/dust bag	134.95
SB8T	3" x 24" Belt Sander 2 sp. w/dust bag	173.25
TR-6	Laminate Trimmer	93.95
TR-8	1 HP Plunge Router	133.30
TR-12	3 HP Plunge Router	175.95

## SUNGOLD X-WEIGHT SANDING BELTS

Sold in packs of 10 only. Outlasts regular belts 2 to 1.

Size	Grit	10 Belts	50 Belts
3" x 21"	120	\$.98 Ea.	.84 Ea.
	100	.98 Ea.	.84 Ea.
	80	1.00 Ea.	.86 Ea.
	60	1.05 Ea.	.92 Ea.
	50	1.07 Ea.	.94 Ea.
3" x 24"	40	1.10 Ea.	.96 Ea.
	120	1.20 Ea.	.93 Ea.
	100	1.20 Ea.	.93 Ea.
	80	1.22 Ea.	.97 Ea.
	60	1.26 Ea.	1.12 Ea.
	50	1.31 Ea.	1.15 Ea.
4" x 24"	40	1.34 Ea.	1.18 Ea.
	120	1.68 Ea.	1.46 Ea.
	100	1.68 Ea.	1.46 Ea.
	80	1.73 Ea.	1.51 Ea.
	60	1.78 Ea.	1.64 Ea.
	50	1.85 Ea.	1.70 Ea.
	40	1.89 Ea.	1.76 Ea.

## SUN GOLD SANDING SHEETS

Grnt	Pk of 100
150, 120, 100	\$21.95
80	23.70
60	28.90
50	32.05
40	38.30

## 9 x 11 Non-Loading Silicon Carbide A WEIGHT

Grnt	Pk of 100
400, 360, 320, 280, 240, 220, 180	\$19.60
150, 120	\$21.95

## FREUD SAW BLADES 10"=5/8" Bore Carbide Tipped 12"=1" Bore.

No.	Size	Leath	Use	Price
LU72M10	10"	40	General	\$33.95
LU73M10	10"	60	Cut-Off	29.95
LU73M12	12"	72	Cut-Off	76.90
LU78M10	10"	80	Plastic	83.50
LU82M10	10"	60	Cut-Off	39.95
LU82M12	12"	72	Cut-Off	85.95
LU84M11	10"	50	Comb.	36.95
LU85M10	10"	80	Cut-Off	59.95
LM72M10	10"	24	Ripping	33.95
DS306	6"	Dado		89.95
DS308	8"	Dado		99.95

If a prepaid price for an identical product in our ad is lower, we match the price and give you a gift certificate worth \$5.00 when purchasing from our catalog. Few restrictions apply.

**Minimum Order \$15.00**

**Freight prepaid in all U.S.A. on orders of \$35.00 or more.**

Note: Under \$35.00 add \$2.50 per order. Extra charge to Alaska and Hawaii on stationary machines. Typographical errors are rare but do occur. Any error is subject to correction by Trend-Lines. This ad expires June 30, 1986.

**FREE CATALOG WITH ORDER OR BY WRITING TO POST OFFICE BOX.**

**SPECIAL SALE TO READERS OF THIS AD: You Must Mention This Ad When Ordering 800-343-3248 (USA) 800-322-6100 (Mass.) 617-864-8882 (Non-Order Calls)**

## TREND-LINES, INC.

375 Beacham St. P.O. Box 6447A Chelsea, MA 02150



or personal check

Open Mon.-Fri., 8 a.m.-5 p.m., 9-5 Sat.

## 30 DAY MONEY BACK GUARANTEE

Examine any item in your home or shop. If it's not what you expected, return it in original condition for a full refund.

Water Danish Oil \$5.70 Qt. TITEBOND WOOD GLUE Natural, Medium, Dark, Black, or Colors. \$5.70 Qt. \$12.95 Gal. \$17.65 Gal.

## FREE WITH ANY ORDER

• 39 1/2" Pocket Tape Measure. (\$3.95 Value)



Also free with any order: • 1 year (3-4 issues) catalog subscription. • Subscription to Woodworking Trends. • Membership to TLC with special offers. • For special prices ask for code FWMJ6.

## 21 PIECE FORSTNER & BRAD POINT SET

• 7 pc. Forstner Bit Set in sturdy wooden case. • 7 pc. Brad point woodbit set in protective pouch. • 7 pc. adjusting collars for woodbit set.



YYFB21W \$49.95

## SUPER SAVINGS ON ALL FREUD BLADES

Free Saw Safe Pusher With Every Blade



FREUD 60 TOOTH INDUSTRIAL CARBIDE CUT-OFF SAW BLADE. LU73M10 \$29.95

## DELTA CONTRACTORS SAW

\$100 REBATE BY MAIL! EXPIRES 6/30/86 RW34410SP \$699.00 With Rebate \$599.00



RYOBI CORDLESS DRIVER/DRILL PACKAGE BD1020RS \$89.95

**GREAT VALUE FROM CANADA**

**DELTA (ROCKWELL)**

\*34-457SXF 3 HP UNISAW (UNIFENCE MODEL) **\$1299<sup>00</sup>**



- All Electrics Are Fully Compatible With U.S. Electrics
- Includes Magnetic Starter

\*22-651 (RC-33) 13" PLANER C/W 2 HP MOTOR AND MANUAL STARTER **\$1099<sup>00</sup>**

FREE STAND INCLUDED IN PRICE!

\*28-540 16" - 3 WHEEL BANDSAW C/W 1/2 HP Motor - Including Mitre Gauge and Rip Fence (Extra Blades 1/4" or 3/8" \$4.95 Each) **\$299<sup>00</sup>**

**ALL ELECTRICS MEET CANADIAN REGULATIONS  
ALL DELTA MACHINES SHIPPED FREIGHT COLLECT PLUS DUTY CHARGES**

**LEIGH DOVETAIL JIGS**

\*1258 - 12" DELUXE MODEL... **\$249<sup>95</sup>**

\*1258 - 24" DELUXE MODEL... **\$299<sup>95</sup>**

CARBIDE ROUTER BITS INCLUDED  
FREIGHT SHIPPED PREPAID

**HOUSE OF TOOLS LTD.**  
131 - 12th AVE. S.E.  
CALGARY, ALBERTA, CANADA T2G 0Z9  
PHONE (403) 269-7365

Better By Design<sup>®</sup>  
**POWERMATIC III**

**MODEL 66, 10" TA SAW**  
3 HP, 1 PH, 230 Volt  
Mag. Control  
YOU PAY.....\$1695  
FREE 8" Adjust. Dado Blade  
For Biesmeyer Fence  
Add \$99



**MODEL 60, 8" JOINTER**  
with stand  
1 1/2 HP, 1 PH, 115 Volt  
Switch  
YOU PAY.....\$1319



**MODEL 26 - SHAPER**  
1/2" & 3/4" Spindles,  
3 HP, 1 PH, 230 Volt  
Mag. Control  
YOU PAY.....\$1750



supplies limited      FOB McMinnville, TN

**BRADY CORP.**  
649 MADISON AVENUE  
P O BOX 326  
ELMIRA N Y 14902 0326  
607-733-6591

Fine  
**Woodworking**

**Slipcases for your back issues**

Bound in dark blue and embossed in gold, each case holds at least 6 issues of *Fine Woodworking* (a year's worth), and costs \$6.95 (\$20 for 3, \$36 for 6). Outside the U.S., add \$2.50 each (U.S. currency, please).

Send your order and payment to:

Jesse Jones Industries  
Dept. FW, P.O. Box 5120,  
Philadelphia, PA 19141.

**NEW! HIGH-PRECISION  
SCROLL SAW  
OUTPERFORMS THEM ALL!**



**30-DAY FREE TRIAL!**

Use this high-precision saw to make hundreds of profitable, unusual items... toys, name-bars, filigree work, clocks, holders...the list is nearly endless! Because the Model 1600 cuts so smoothly, sanding is virtually unnecessary!

**BUILT FOR THE PROS!**

The new Woodmaster Model 1600 gives you a big 16-in. throat capacity, 2-in. cutting depth, a generous, oversize worktable, ball-bearing drive...and much more!

**30-DAY FREE TRIAL!**

Send for Complete Facts! See how you can use the Model 1600 in your own shop for one full month without risk! Easy terms. MAIL COUPON TODAY!

Call Toll-Free 1(800) 251-4888

SEND FOR FREE FACTS TODAY!

**SCROLL SAW FACTS**

Woodmaster Power Tools  
Dept. CE13  
2908 Oak  
Kansas City, MO 64108

YES! Please rush my FREE Information Kit and details on your 30-Day Free Trial Guarantee!

Name \_\_\_\_\_  
Address \_\_\_\_\_  
City \_\_\_\_\_  
State \_\_\_\_\_ Zip \_\_\_\_\_

**EDLCO**  
Appalachian Hardwood Specialists  
Now Serving Craftsmen  
Select from over 21 species  
Imported And Domestic Hardwoods  
Softwoods  
Veneers Shorts Turnings  
Kiln Dried Delivered Prices  
New Catalogue \$2.00  
Write today **EDLCO**  
Box 5373 FW  
Asheville, N.C. 28813  
Phone (704) 255-8765  
Stay In The Woods With Us



**EDUCATIONAL LUMBER CO., INC.**

A good miter is hard to find.



**Now you know where to look!**

**POOTATUCK CORPORATION**  
P.O. Box 24, Dept. FW865  
Windsor, VT 05089 (802) 674-5984

Name \_\_\_\_\_  
Address \_\_\_\_\_  
City/State/Zip \_\_\_\_\_

**RYOBI**

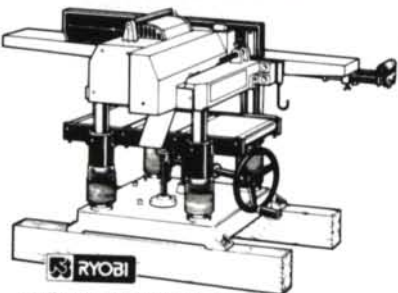

12 1/2" PLANER-JOINTER AH-115

**RYOBI Portable Power Tools & Stationary Woodworking Machines at Super Low Prices!**  
Call toll free for catalog, pricing, technical information, etc.  
**Made for more than weekends!**

**CAPITOL CARBIDE CO.**  
1000 University • St. Paul, MN 55104  
WATTS 1-800-328-8152 • (612) 644-9622

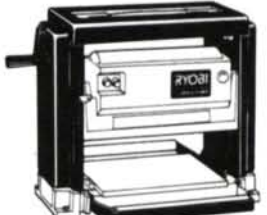

10" PLANER AP-10

# THE DOOR SHOP™

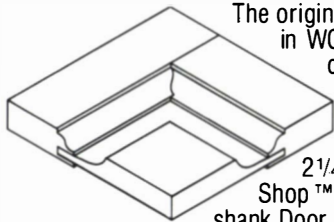

The original Ogee **DOOR SHOP™** as featured in **WOOD MAGAZINE (MAY/JUNE 85)** is complete with stile & rail, slot & panel raising bits for the 1/4" chuck router. Bits are carbide tipped & BB & will make 3/4" thru 2 1/4" thick raised panel doors. Door Shop™ & Manual \$89.50 ppd. The 1/2" shank Door Shop™ now available.

The 35 page **DOOR SHOP™ MANUAL** is clearly written and beautifully illustrated with over 156 detailed drawings covering the complete process of door building. Each section covers proper methods and exact set ups for the router, including how to recognize and correct for errors. There are sections covering Design, Lumber selection, Measuring, Panel Raising, curved & straight Rail and Stile cutting & fitting, Guides, Clamping, Gluing and Finishing. This is the most comprehensive manual out today. When purchasing the Door Shop™ manual for \$5.00 you also receive Zac's 32 page Router bit and Shaper-cutter catalog free. \$5.00 rebated with purchase of our Door Shop™ or Panel Raiser™ bits.

Zac's carbide tipped **PANEL RAISER™** router bits come in 3 styles; Ogee, COVE, & PROVINCIAL. All 1/2" shank bits are 3 1/2" in diam., with BB & give a full 1 1/2" raised panel. \$99.50 @ ppd. All 1/4" shank bits are 2" in diam. & give a 1" or larger raised panel cut. \$65 @ ppd.



TO ORDER  
CALL 800-  
441-0101

IN NY 212-  
947-4496

**ZAC PRODUCTS INC.** 533 West 34th Street NYC, NY 10001

# RIPSTRATE®

**The Finger Saver  
That Saves Work . . . .  
And Improves the Job . . . .**

Most safety devices require frequent adjustment. They usually wind up in a corner, not saving anything at all.

The RIPSTRATE guides the work against the fence. It requires no adjustment. No hands near the blade. No leaning over the saw table. No spoiled stock. NO KICKBACKS. No hassle. Just straight, clean cuts.

No wonder thousands of woodworkers, from amateur and professional craftsmen to large corporations, to government institutions, to colleges, to Air Force bases, now regard the RIPSTRATE as an essential part of their woodworking shops. After all, we are only born with ten fingers.

30 day money back trial. One year guarantee. \$62.50 plus \$3.50 shipping. Check, M.O., Visa or M/C. Free brochure.

Write or call our toll free number.  
**800 421 0256**

**FISHER HILL PRODUCTS**  
1 Fisher Hill  
Fitzwilliam NH 03447

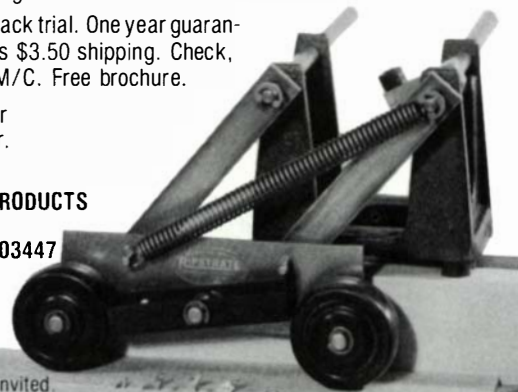

Dealer inquiries invited

## INTRODUCING — NEW BRIDGEWOOD® MACHINES FOR 1986 NATIONALLY ACCLAIMED BRAND NAME PROFESSIONAL MACHINERY

**PIN ROUTER**  
TRACER TYPE - 2HP 1PH



\$1195 FOB YORK, PA  
MODEL PR-120

**SPINDLE SANDER**  
OSCILLATING - 1HP 1PH



\$1195 FOB YORK, PA  
MODEL YL-2000

**SHAPER 3HP 1PH**  
1/2"-3/4"-1" SPINDLE



\$1195 FOB YORK, PA  
MODEL BW3S

**WIDE-BELT SANDERS**  
25" & 37" WIDTHS  
10HP/15HP 3PH



\$5650 (25") FOB YORK, PA  
\$8750 (37") FOB YORK, PA

**BRIDGEWOOD® WOODWORKING MACHINERY IS CAREFULLY CHOSEN BY OUR STAFF OF PROFESSIONALS. EXTENSIVE FAMILY EXPERIENCE IN WOODWORKING FROM THE "OLD COUNTRY" IS PASSED ON FROM GENERATION TO GENERATION ASSURING YOU, OUR VALUED CUSTOMER, THE BENEFIT OF THIS PRICELESS ACCUMULATED TECHNICAL KNOWLEDGE.**

SEND \$1.00 FOR FULL LINE CATALOG OF BRIDGEWOOD® WOODWORKING MACHINERY AND **WMC®** METALWORKING MACHINERY. YOU CAN BUY WITH CONFIDENCE WHEN YOU BUY FROM WILKE.

**INSIST ON AUTHENTIC, GENUINE BRIDGEWOOD® MACHINES — ACCEPT NO SUBSTITUTES!**

# WILKE MACHINERY CO. INC.

120 DERRY COURT 717  
YORK, PA 17402, U.S.A. 846 2800

A FULL LINE, FULL SERVICE MACHINERY CO. - NOT A POST OFFICE BOX OR 800 NUMBER - YOU CAN TRUST WILKE - A FAMILY OWNED AND OPERATED COMPANY - WE KNOW MACHINERY - HOW IT WORKS & HOW TO FIX IT.

# ELEKTRA BECKUM



THE PERFECT  
COMBINATION

## HC260 JOINTER/PLANER 'and' SPA1000 DUST EXTRACTOR

- Hardened 40" tables
- Width of jointer and planer 10 1/4"
- Max. thickening depth 6 1/2"
- 63 cuts per inch
- 2.4 HP, 220V
- 2.4 HP, 110V
- 4.2 HP, 220V
- A clean work environment
- 765 cfm suction capacity
- 4" x 98" heavy duty hose
- Use any standard trash bag
- 3/4 HP motor 110/1/60

\$1250.00  
\$1295.00  
\$1375.00

**\$450.00**

Suggested list price  
FOB Somerdale, NJ



Send \$1.00 for full color catalog to:  
ELEKTRA BECKUM USA DEPT HCS  
PO BOX 24, SOMERDALE, NJ 08083  
Call for your local dealer: 1-800-223-8600  
See these machines demonstrated at:  
Kansas City May 2-4  
Dallas May 2-4

# A CHANDLER & CO



## CABINET MAKERS WORK BENCHES

We hand build each work bench from well-seasoned Northern Hard Maple.

If you require a very substantial bench of the highest quality, that will last a life time write or 'phone for details.

6005 Milwee # 709 Houston, Texas, 77092  
**(713) 683 8455**

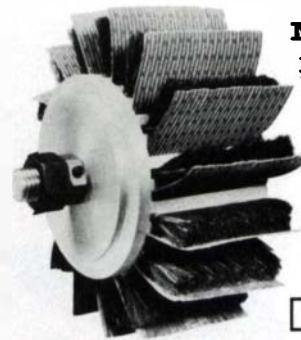

## NEW, SELF-FEEDING Model #B-12 Brush Head

replaces hand sanding on all types of shaped surfaces including mouldings, furniture, and carvings.

Write for brochure and price list.

**Sand-Rite MFG. COMPANY**

1611 NORTH SHEFFIELD AVENUE • CHICAGO, ILL. 60614 • 312/642-7287

WORLD'S SMALLEST SHAPER CUTTERS  
FOR MAKING RAISED PANEL DOORS  
3 WING CARBIDE TIPPED, 1/2" BORE  
"CUSTOM-MADE" FOR YOUR 1/2" ROCKWELL,  
CRAFTSMAN OR EVEN SHOPSMITH MACHINE

### A. RAISED PANEL CUTTERS



R 1

1/2" Bore, 4 1/4" Dia.  
for 3/4" Panel, Extra  
Thick 3MM Carbide,  
3 Styles Available  
Only \$72 ea.



R 2



R 3



### B. 2 CUTTER RAIL AND STILE SET



1/2" Bore, 2 3/4" Dia.  
For 5/8"-7/8" Material  
Only \$145 per set

Please add \$3 for Shipping per order. We also have Door Sets for 3/4" Shapers and 1/2" Routers. Please Call For Details.

### MANNY'S WOODWORKER'S PLACE

602 S. Broadway, Lexington, KY. 40508  
Hours: 10 - 5:30 Mon.-Sat.  
VISA, MasterCard, Checks, COD (\$3)  
Ask for free sales brochure.

### ORDER TOLL FREE

1-800-243-0713  
in KY call  
606-255-5444

# LASER WOOD!

Engrave/Cut fine details in  
Wood, Plastic, Glass, etc.

WE DO CUSTOM LASER ENGRAVING  
MANUFACTURE AND SELL LASER ENGRAVERS

For Brochure and Sample - call or write:



**Laser Machining, Inc.**

P. O. Box 219 Somerset, Wisconsin 54025  
Phone (715) 247-3285

One Source For

QUALITY  
Furniture & House  
HARDWARE

Stock or Made To Order

Call or write for your Free  
Mini-Catalog of Quality House  
and Furniture Hardware Or  
send \$5.00 for our complete 108  
page Catalog, now including  
many new Victorian Products.

**BALL and BALL**

436 W. Lincoln Hwy.  
Exton, PA 19341  
(215) 363-7330

## Wood Moisture Meters

Pocket-Size  
MINI  
LIGNO  
\$110

Only



High quality moisture tester for the serious hobbyist or the professional woodworker:

- Moisture range 6-20%, indicates 1% steps
- Battery safe on/off switch between pins
- Portable with protective cap over pins
- Rugged case in high impact plastic
- Handy shape for convenient use
- For lumber, veneer, fiberbrds

Call toll free 800-227-2105

Free brochures on line of moisture meters ( range 4-30%, 4-60%) and accessories to monitor air and kiln drying available.

Incl. Case, Batteries, and Pins for 7/16" and 7/8" Measuring Depth. Size: 1" x 2 1/4" x 5 1/2"

**Lignomat**  
USA LTD

P. O. Box 30145 fw  
Portland, OR 97230

Tel: 800-227-2105  
503-257-8957

The best prices in the country for Amana's professional line of carbide tipped saw blades with extra large carbide tips. Try it!! You will like it!!

Catalog No.	Diameter	Teeth	Use	Sale
GP-450 ATB	10	24	Ripping	\$24.75
FC-550 ATB	10	40	General	\$26.00
FC-560 ATB	9	60	Cut-off	\$33.00
FC-570 ATB	10	60	Cut-off	\$29.00
CS-910 COMB	10	40	Comb	\$27.00
CS-920 COMB	10	50	Comb	\$31.00
PC-670 TCG	10	60	Cut-off	\$33.00
FC-520 ATB	7 1/4	40	Fine Cutting	\$20.65
DS-610	8	18	Dado Set 3	\$89.00

### • Woodmere Saw & Tool •

1840 Newbridge Rd., Bellmore, NY 11710

Call 516/785-2800

# The Sawmill

(800) 345-3103 • NO MINIMUM ORDER

## EXOTIC AND DOMESTIC HARDWOODS

BUBINGA	ROSEWOODS	CHERRY	WENGE	1/8", 1/4", 1/2"
EBONIES	MAHOGANIES	WALNUT	ZEBRA	4/4, 6/4, 8/4
PADAUK	KINGWOOD	MAPLE	BOCOTE	Surfaced
SHEDUA	ZIRICOTE	MORADO	& MORE	or Rough

CUSTOM CUTTING, RESAWING, & ABRASIVE PLANING

WHOLESALE & RETAIL INQUIRIES WELCOME

ASK FOR: "TELEWOODS" PA RESIDENTS CALL (215) 759-2837

A DIVISION OF THE MARTIN GUITAR COMPANY, NAZARETH, PA 18064

## The Oily Wood Solution

G2 Epoxy is specially formulated to bond to cocobolo, rosewood, teak, oak, and cedar. Also to metals, glass and most plastics. G2 is a flexible, gap-filling, superior adhesive.

Try G2. Order the 375ml kit (includes resin and hardener, protective gloves, stir sticks, mixing cups and product literature) for just \$12.95 postpaid. CALL TODAY.



IFC epoxies, including G2, Cold Cure, and 5 Cure, are distributed exclusively in the U.S. by:

**HEADLAND INTERNATIONAL, INC.**

2020-124th Ave. N.E., #C-102  
Bellevue, WA 98005 (206) 885-0622

Trade inquiries welcome.

# Magna-Set

FAST, EASY TO USE

Patent Pending

ACCURATELY  
RESET JOINTER  
KNIVES IN  
10 MINUTES!

- Magnetically holds knives in perfect position
- Steel, Brass & permanent magnet construction
- Life-time guarantee

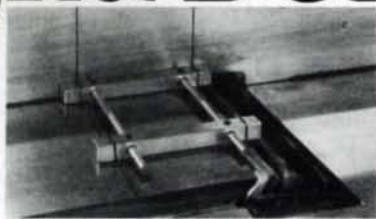

Adjustable, fits any size jointer  
**\$39.95** plus \$2.50 post. & hand.

QUEST INDUSTRIES, P.O. BOX 7768, MURRAY, UT 84107 801-973-0896

## DELTA 10" CONTRACTOR'S SAW

#34-410 - Saw, Stand, Wings Complete

#62-042 - 1 1/2 H.P. Motor

LIST \$1073.00

NOW \$688.00

Less Factory Rebate \$100.00



\*All Previous Sales Excluded.  
Offer Expires June 30, 1986.

YOUR END COST

**\$588.00**

### 13" PLANER

#22-651

Model 22-651  
Shown with  
Accessory Stand



LIST \$1729.00  
**\$998.00**

### MOTORIZED MITER BOX

#34-010



LIST \$231.00  
**\$159.00**

### 12" LATHE

#46-5415

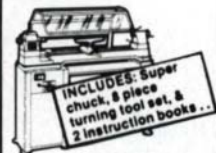

LIST \$2771.00

**\$1399.00**  
Only A Few Left—  
While They Last!

EAST OF THE MISSISSIPPI—FREE FREIGHT  
WEST OF THE MISSISSIPPI—FREIGHT ALLOWANCE

**PHILIPPS BROS. SUPPLY, INC.**

Construction and Industrial Supplies

2525 KENSINGTON AVE. • BUFFALO, NY 14226 • 716 839-4800

CALL TOLL FREE: 1-800/544-4466

IN N.Y.S.: 1-800/238-4466



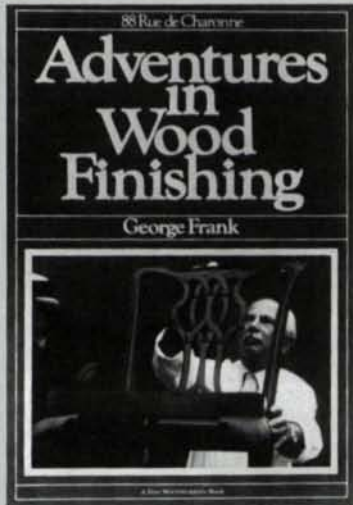

## A lifetime of trade secrets

Few people know wood finishing the way George Frank does. As one of Europe's most sought-after craftsmen during the 1920s and 1930s, he tackled an incredible range of finishing jobs for an equally incredible array of customers. In one case, he produced a colorless dining room set for a French baron; for the Royal Court of Egypt he found a way to flawlessly fake a whole room full of Louis XIV chairs.

To meet these and other challenges, Frank developed a vast repertoire of finishing techniques, refining old methods, inventing new ones and experimenting with everything from a blow-torch to peroxide bleach. In this book he shares his discoveries and secrets—from the old-timers' recipes for dyes and stains to the culmination of Frank's own search for the perfect wax; from a mirror finish that shines to an "antique" finish that fools even the experts.

Along with the colorful stories that fill his book, Frank tells you everything you need to know to create beautiful finishes in the old manner.

*Hardcover, 128 pages  
\$10.95 postpaid  
Publication #14*

To order: Please use the insert after page 18 or call toll-free, 1-800-243-7252, and use your credit card.

**Cascade Precision Tool Co.**  
Box 848, Mercer Island, WA 98040

OFFERING PREMIUM QUALITY S BRAND CARBIDE TIPPED ROUTER BITS AND SHAPER CUTTERS

FREE 1/4" DOVETAIL WHEN YOU ORDER THIS SET OF CARBIDE-TIPPED ROUTER BITS INCLUDING 3/4" RABBIT, 3/2" OGEE, 1/2" COVE, 1/2" ROUND-OVER, 1/2" AND 1/4" STRAIGHT BITS WITH EXTRA BEARING FOR BEADING.  
1/4" SHANK SET \$64.95 PPD. 1/2" SHANK SET \$69.95 PPD.

CARBIDE TIPPED 3 PIECE ROUTER BIT SET WITH 1/2" SHANK AND 3/2" O.D. PANEL RAISER AVAILABLE IN 5 PROFILES BELOW. RAUSTYLE CUTTERS AVAILABLE IN ROUND-OVER, OGEE AND TRADITIONAL PROFILES \$179.95

SWING-PANEL RAISERS IN 5 PROFILES 3mm (1/4") CARBIDE \$69.95 ea.  
4 3/4" O.D. WITH 3/4" BORE & 1/2" BUSHING OR 5 1/2" O.D. WITH 1 1/4" BORE & 1" BUSHING

5° FACE CUT    15° FACE CUT    CONCAVE    12° FACE & QTR RD    CONVEX

HEAVY DUTY SHAPER CUTTERS, 3/4" BORE WITH 1/2" BUSHING from \$29.95

6-PIECE CABINET SETS 3/4" BORE WITH 1/2" BUSHING from \$149

S BRAND "MAGNUM LINE" SHAPER CUTTERS - CABINET/DOOR SETS  
4 Wing • 1 1/2" Bore (1" Bushing) • 4"-4 1/2" Diameter • 3mm (1/4") thick carbide  
AVAILABLE AT AFFORDABLE PRICES

ORDER BY PHONE WITH VISA/MC OR SEND MO. CHECK, VISA/MC NUMBER, EXP. DATE, PHONE NUMBER, CATALOG \$1 - FEATURING OVER 200 CARBIDE TIPPED ROUTER BITS AND SHAPER CUTTERS.

DEALER INQUIRIES INVITED    SATISFACTION GUARANTEED ORDER TOLL FREE 1-(800) 235-0272  
IN WASHINGTON CALL 1-206-236-0272 CHARGE YOUR ORDER 10 AM-7 PM Monday thru rough Saturday

MADE IN U.S.A.    NEW! POWER-FEED

### DRUM SANDER

30-DAY FREE TRIAL!

12 in. and 26 in. models

FREE DETAILS

**A Finish Sander... A Thickness Sander**  
You can use this high-tolerance machine for light dimensioning as well as the finest finish work. Because stock is power-fed at a uniform rate, you'll achieve results impossible to duplicate with hand methods or hand-held sanders. Dimensions remain exact... no more low spots, waves or cross grain marks!

#### Improves Results!

Use the Woodmaster to dimension and finish-sand cabinet pieces, resawn stock, paneling, grandfather clocks, toys, tabletops, knees, burlis, crotches, and much, much more! You'll soon find it's one of the most valuable tools in your shop!

#### 30-Day FREE TRIAL

Send for Complete Facts! See how you can use the Woodmaster Drum Sander in your own shop for 30 days completely without risk! Easy terms.

Call Toll-Free Today 1(800) 251-4888

Woodmaster Tools, Dept. DS15, 2908 Oak Kansas City, MO 64108

YES! Please rush my FREE Information Kit and details on your 30-Day Free Trial Guarantee.

Name \_\_\_\_\_  
Address \_\_\_\_\_  
City \_\_\_\_\_  
State \_\_\_\_\_ Zip \_\_\_\_\_

## MAKE TOYS & WOOD PROJECTS

7 CAR TRAIN  
\$6—Plan only.  
\$27.50—Plan & turned parts (92 parts in all!).  
Visa & M/C

62" long

100's of plans, kits, colored & unfinished hardwood parts for toys, crafts & furniture; plus tools, wood, finishes & supplies. Bulk prices available. Color catalog subscription \$1. (614)484-4363

Cherry Tree Toys, Box 369-19, Belmont, OH 43716

## FROG'S CATALOG!

108 PAGES HAND WOODWORKING TOOLS & BOOKS

FREE!

MAIL: FROG TOOL CO. LTD., DEPT. FW2  
P.O. Box 8325, Chicago, IL 60680  
West of Rockies  
P.O. Box 938, Ojai, CA 93023  
Showroom: 700 W. Jackson Blvd., (Chgo.)  
Phone (312)648-1270

## Imported European Hardware

3820 Schiff Drive  
Las Vegas, Nevada 89103  
(702) 871-0722  
SEND \$1.00 FOR CATALOG

FWW

## TOP QUALITY AT LOW, LOW PRICES

10 - 40" Planers  
Wider Belt Sanders  
Plus Full Line.  
We Sell to Dealers

Incredible 3 Year Warranty  
Why Accept Less?  
Don't Take Risks  
Buy from the Midwest's #1 Planer Store

FREE FREIGHT Continental USA  
30 Days to Return for Cash Refund

### PRO SHOP

POWER TOOLS

309 N. Rte. 83, Elmhurst, IL 60126  
(312)832-3803

**BAND SAW BLADES**  
WELDED TO YOUR EXACT LENGTH

WIDTHS	TEETH	PRICE/INCH
1/8" thru 5/8"	3 thru 32	\$.05

**COMPLETE BAND SAW BLADE LINE INCLUDING SAW MILL BLADES**  
TO FIGURE PRICE:  
Inch Length x Price/Inch + \$1.85 Weld Charge

**MINIMUM ORDER \$10.00.** Add \$2.50 per order for packing and shipping. MasterCard and VISA accepted.

TO ORDER Phone or write to:  
**BUCKEYE SAW COMPANY**  
P.O. Box 14794, Cinti., OH 45214  
1-800-543-8664 (Except Ohio)  
1-513-621-2159 (In Ohio)

## A NEW TOOL!



Just set your blade, accujoint will index your work exactly!

PERFECT EVERY TIME

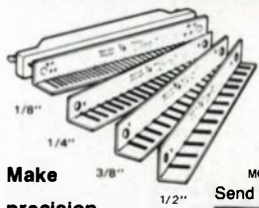

Only **\$39.95**

□ PLUS \$2 (in U.S.)  
Shipping & Handling  
Mass. residents add 5% tax

**MONEY BACK GUARANTEE**  
Send Check or Money Order

Make precision finger joints on your table saw!

Morse Design  
P.O. Box 195  
Boston, MA 02123

## over 20 different Hardwoods!

**Direct Mill Savings**  
Domestic and exotic. Plus pressure-sensitive veneers, carving knives and tools, clamps, buttons and pins and glues.

Send for FREE New Catalog

American Woodcrafters

1025 South Roosevelt  
Piqua, OH 45356

Phone 513-773-7414 Ext. 291

## Wood-Mizer® Portable Bandsaw Mill

One Man Operation  
Capacities to 32" Dia. x 32' Long  
More Lumber Per Log  
Safe - Precise

Three Models Available

For catalogs on our complete product lines, send \$1.00 to:

Wood-Mizer® Products  
Dept. Z15  
8180 W. 10th St.  
Indpls, IN 46224  
(317) 271-1542



Name \_\_\_\_\_  
Address \_\_\_\_\_  
City \_\_\_\_\_ State \_\_\_\_\_ Zip \_\_\_\_\_

## DELTA 10" Contractor's Saw for \$599. You Can't Get More Value In A Table Saw Than This.

Delta's 10" Contractor's Saw has a powerful 1 1/2 HP motor, full 3 1/8" depth of cut, large massive table, exclusive Jet-Lock, Micro-Set® rip fence, 25" rip capacity and, of course, the smooth and easy operation you expect from all Delta Machines.

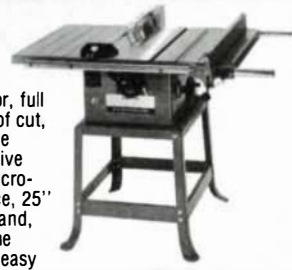

At 265 pounds, this saw is not like most other open-stand table saws. It is a massive precision tool. The complete package includes the saw, a steel combination blade, miter-gauge, stand and motor. We have added a FREE adjustable dado and table insert to give you added flexibility.

Our price includes freight to anywhere in the 48 states.  
You get a \$100 rebate directly from Delta  
33-410S Delta 10" Contractor's Saw with FREE adjustable dado and table insert  
List \$1,128.86 SALE \$699.00  
Your cost after rebate \$599.00

### Woodworker's Supply

5604 Alameda, NE • Dept., FWW  
Albuquerque, NM 87113  
Toll-Free: 1-800-645-9292 VISA/MC

## UNLOCK YOUR CREATIVITY ...

### WITH THE RBI HAWK PRECISION SCROLL SAW



Make 100's of projects . . . toys, name cut-outs, inlays, scallops, puzzles . . . to sell, gift-giving. Cuts wood, metal and plastic. The answer to crafts-persons' prayers!

Hawk 20" Model

Send Today for free information kit!

rbi 1801 Vine Street  
Harrisonville, MO 64701

□ YES. Tell me about your 30-day "In The Shop" Guarantee of Satisfaction!

Name \_\_\_\_\_  
Street \_\_\_\_\_  
City \_\_\_\_\_  
State \_\_\_\_\_ Zip \_\_\_\_\_  
© 1986 RBI, Inc. (please print) S-23

## LENEAVE-QUALITY

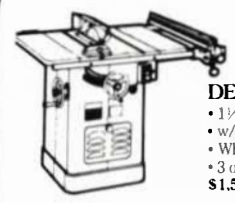

**DELTA "UNISAW"**  
• 1 1/2 HP \$1,199.00 +FT.  
• w/carbide blade  
• While supply lasts  
• 3 or 5HP models  
\$1,535.00

**15" PLANER**  
• Model 315  
• 3HP motor  
• Cast iron construction  
• Magnetic controls  
• 1 year warranty  
• Dust hood  
• Table extensions  
• Anti Kickback  
• \$795.00



**15" PLANER PRICE BREAKTHROUGH**  
• Model 310 15" Planer  
• Powerful 3HP motor  
• Cast iron construction  
• Magnetic switch  
• 1 year warranty  
• Outstanding quality  
• \$725.00

### SP-101 Cabinet Shop Shaper

• 3HP single phase  
• 5HP triple phase  
• 2 reversible speeds  
• 2 spindles, 1", 3/4", 1/2" and 1/4" opt.  
• Router bit collets available  
• Large table 28" x 40"  
• 1 year warranty  
• Extra heavy duty  
List \$1,600.00  
Sale \$1,175.00  
Free Freight

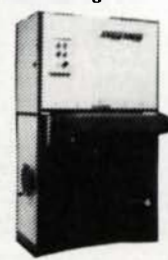

**SDM Wide Belt Sanders**  
• Platen head  
• Dual motors  
• Heavy cast iron & steel plate construction  
• 10 & 15HP  
• Best buy in the industry!  
• 25" List \$7950.00  
Sale \$5,595.00  
• 37" List \$12,000.00  
Sale \$8,750.00  
Free freight

### CT-200 8" Cabinet Shop Jointer

• Heavy cast iron construction  
• 2HP Single phase  
• 9"x67" bed  
• 3 knife cutterhead  
• Dual tilt fence  
• Magnetic controls  
• List \$1,350.00  
Sale \$895.00  
Free freight  
• 6" jointer unit \$325.00



- 14" 1HP band saw \$269.00
- Belt-disc sander \$250.00
- Home shop shapers \$295.00
- 20" planers from \$1,975.00
- R.B.I. scroll saws
- Dewalt saws
- Porter-Cable power tools

**LENEAVE SUPPLY**  
305 W. Morehead St.  
Charlotte, NC 28202  
(704) 376-7421

# CLASSIFIED

The CLASSIFIED rate is \$5.00 per word, minimum ad 15 words. All payments must accompany orders; all are non-commissionable. The WOOD & TOOL EXCHANGE and SITUATIONS WANTED are for private use by individuals only; the rate is \$7 per line. Minimum 3 lines, maximum 6 lines, limit 2 insertions per year. Allow 30 letters or spaces per line, including name and address. DISPLAY CLASSIFIED rates on request. Send to: *Fine Woodworking*, Advertising Dept., Box 355, Newtown, CT 06470. Deadline for the July/August issue is April 25th, for the September/October issue, June 25th.

## Busn. Opportunities

**IF YOU HAVE A PRODUCT** or product/idea, we can manufacture, promote and market it paying you a royalty. Proven track record. Craftmark, Box 6308, Marietta, GA 30065.

**FOR SALE IN BRITISH COLUMBIA.** Established woodworking business and giftware product line. Block building, 1/2 acre industrial park, machinery, trademark, accounts, \$105,000 Canadian dollars plus inventory. Reply to Box 1962, Salmon Arm, B.C., Canada V0E 2T0.

**WANTED: NEW WOODWORKING TOOLS** to sell through our national mail-order catalog. Woodcraft Supply Corp., Merchandise Department, 41 Atlantic Ave., Woburn, MA 01888.

**WANTED!!** Professional woodworking tools, precision made quality and guaranteed. To be sold by us, as your exclusive distributor in Kansas. Call toll free 1-800-341-0062. In Kansas call 1-316-262-8485. Brush and Board-Hardwoods, 923 E. Gilbert, Wichita, KS 67211.

**CUSTOM CABINET SHOP** in beautiful Boulder, Colorado. 1985 gross sales, 150K. 3,000 square feet, shop and office. Fully-equipped, ready-to-run. \$35K-45K depending on terms. PO Box 9002 #311, Boulder, CO 80301.

**HARDWOOD BUSINESS.** Successful Washington state location, \$100,000+ gross, established market, excellent inventory-exotic/domestic-equipment. Will train qualified buyer. 1604 Larrabee Ave., Bellingham, WA 98225.

**WOODWORKING SHOP,** tools, materials, designs, business, inventory, van, pick-up, 3BR home, 2 1/2 acres. Indiana. \$35,000 annual, 20% down, 10% contract, \$32,000 gross. Furniture, R #1, Box 174, Lyons, IN 47443.

**CUSTOM CABINET SHOP,** specializing in commercial contracts. Near Fort Collins, CO, a rapidly growing area. Grossing \$80,000, asking \$40,000. Write, Castlewood, Box 163, Timnath, CO 80547.

**DEALER  
INQUIRIES INVITED**



We are a direct importer stocking all quality hand tools needed for a woodworking tool store or specialty department. Resale only—no enduser sales.

Robert Larson Company, Inc.  
82 Dorman Avenue  
San Francisco, CA 94124 (415) 821-1021

## Instruction

**WOODWORKING,** design, marketing, low tuition. Located in Smokey Mountains. Production Crafts, Haywood Technical College, Clyde, NC 28721.

**WENDELL CASTLE SCHOOL.** College of Furniture Design and Woodworking. For catalog: 18 Maple St., Scottsville, NY 14546. (716) 889-1521.

**APPRENTICE WITH A MASTER CRAFTSMAN.** A unique inshop experience. Woodworking, furniture design, textiles, ceramics, jewelry, glass, printmaking. Flexible, individual, equitable fee structure. Baulines Craftsman's Guild, Schoonmaker Point, Sausalito, CA 94965. (415) 331-8520.

**PRIVATE TURNING LESSONS.** \$200 per day. Gablecraft, #308, 7125 SW 47th St., Miami, FL 33155. (305) 662-6091.

**TOUCHSTONE CENTER FOR CRAFTS - ROBERT MEADOW.** "Japanese Joinery" Weekend Workshop, July 19 and 20. Also, one-week woodworking classes. Inquiries: Pioneer Crafts Council, PO Box 2141-W, 79 South St., Uniontown, PA 15401. (412) 438-2811.

**BANDSAW OWNERS.** Learn the rewarding technique of making small, unique specialty boxes from solid blocks of wood. Fully illustrated instructions of 15 profitable designs (see displays in former issues). Send \$10 to Box-Art, Dept., FW, Box 8069, Woodridge, IL 60517.

**LEARN FINE FURNITURE MAKING** with master craftsman in professional and teaching workshop. One vacancy remains Oct. '86. Situated beautiful historic area. Apply for prospectus to Christopher Faulkner, Ashridge Workshops, Dartington, Totnes, Devon, TQ9 6EW England.

**LEARN TO TURN.** Two-day concentrated course in all aspects of lathe. Workshop located in converted 18th-century spring house. Individualized instruction. Reading and Lancaster nearby. Send for free brochure. James L. Cox Woodworking School, R.D.1, Box 126, Honey Brook, PA 19344. (215) 273-3840. We use and sell the Myford English lathe.

**PROFESSIONAL TRAINING PROGRAMS** in woodworking, furniture design and architectural woodworking. Nationally accredited, financial aid, housing, job placement. Write: New England Technical Institute, 750 Massachusetts St., Manchester, NH 03103. (603) 669-1231.

**APPRENTICE** with high standards of craftsmanship and commitment. Shaping, sanding, various lamination processes. Exchange four days on for one day on your own learning piece. Send resume to Jere Osgood, RFD 2, Box 178, Wilton, NH 03086.

**ONE-YEAR COLLEGE CERTIFICATE PROGRAM** in woodworking. Write: Elizabeth Bradbury, Woodworking Dir., Jamestown Community College Artisan Center, Jamestown, NY 14701. (716) 484-9920.

**LEARN WOODEN BOAT BUILDING AND DESIGN.** Two full-time residential programs that offer intensive training in a creative but disciplined environment. Equal opportunity enrollment. V.A. approved. The Landing School, Box 1490F, Kennebunkport, ME 04046. (207) 985-7976.

**APPRENTICESHIP** in prominent studio/workshop/showroom. Individual supervision designing and building a full range of furniture from solid walnut/rosewoods using intricate wood joints and pegs - the very finest hand work. Tuition. Jeffrey Greene Design Studio, New Hope, PA. (215) 862-5530 call, don't write, Monday-Friday 9:30 to 4:00.

**RUSS ZIMMERMAN  
TURNERS' WORKSHOPS**  
Turn Better With Personal Instruction.

ZIMMERMAN TURNING LETTER: 9 Comprehensive issues, 220 pages, \$22 ppd. 1986 Subscription: \$9 ppd. SOREY TOOLS, ETC. 44¢ in stamps for brochure, or free with Turning Letter

 MYFORD  
MLA-36" & 42"

RFD 3, BOX 242, PUTNEY, VT 05346

**VIDEOS-FIRST TIME AVAILABLE!** 3-tape series on the router featuring Bob Rosendahl, noted lecturer and author of *The Router*. Tape #1-Router Basics; Tape #2-Table Mounting Your Router; Tape #3-Router Jigs and Accessories. \$39.95 each, all three, \$109.95. See Bob Rosendahl at all Woodworking World Shows. To order write Woodworking Association of North America, PO Box 706, Plymouth, NH 03264, or call (603) 536-3876 for MC/VISA.

**WoodenBoat School**

*Idyllic surroundings • the finest instructors = an exhilarating experience for amateurs and pros alike. For a complete catalog of 140 3-week courses in boatbuilding, seamanship, and related crafts.*

WoodenBoat School  
P.O. Box 78F Brooklin, ME 04616  
1-800-225-5205 (Maine 1-800-225-5800)

## Help Wanted

**CABINETMAKER:** Excellent opportunity for experienced woodworker in well-equipped shop located in New Jersey. Must be able to produce extremely high-end work. Top salary and benefits. Call (201) 442-4023.

**WOODWORKERS/CABINETMAKERS,** min. 3 yrs. experience for custom architectural casework shop. Design ability preferred. Benefits. Minimum begin salary \$17,500 plus OT. General Manager, 116 S. Forbes Rd., Lexington, KY 40505.

**PLUMBER/WOODWORKER.** Journeyman plumber with custom woodworking experience. 358 N. Fifth East, River-ton, WY 92501. (307) 856-6206.

## Situations Wanted

Dedicated woodworker (30) 10 yrs. exp., seeks employment in quality cabinet shop. Have tools, portfolio, resume. Relocating to New England area. Chris Goethe, Rt. 2 GN22, Riverton, WY 82501. (307) 856-0713.

I am an investor, business manager, woodworker looking for woodworking inventions, ideas, or businesses to buy or invest in or joint venture. Write Rick Bermann, PO Box 13037, Cleveland, OH 44115.

Wood finisher seeks challenging job in Connecticut area. Call Jim Young, (203) 599-2705.

College grad., taught two yrs in Japan, seeks apprenticeship to learn quality woodworking techniques in homebuilding and remodeling. Write to Larry H., PO Box 519A, Holland, MI 49423.

Woodworker with 1 year each at Wendell Castle School and Leeds Design seeks work in the Pacific Northwest. 3 years previous experience. Resume and portfolio. Karl Nielsen, PO Box 133, Scottsville, NY 14546.

Enthusiastic married man, 25, seeks position with firm, interested in technical woodworking. 5 yrs. experience with major furniture company in R&D department. D. Green, RR1, Arcadia, WI 54612. (608) 323-3758 evs.

## Travel

**TOUR OF SWITZERLAND** for woodworkers and woodcarvers led by famous author Wayne Barton (*FWW* #55) and Gottlieb Brandli, Swiss cabinetmaker. Fabulous tour of Switzerland's most famous and interesting woodworking/carving areas and most spectacular scenery. For more information Woodworking Association of North America, PO Box 706, Plymouth, NH 03264. (603) 536-3876.

## Accessories

**STAINLESS STEEL AND BRASS** screws and bolts. Small quantities. Catalog, \$1, refundable. Elwick, Dept. 583, 230 Woods Lane, Somerdale, NJ 08083.

**THE FINE GOLD LEAF PEOPLE™,** genuine, imitation sheets, rolls, supplies, and texts. U.S.: Three Cross St., Suffern, NY 10901-4601. Canada: 454 Lawrence West, Toronto, Ont. M5M 1C4.

**MASTER SANDER.** Quickly transform Sears, Belsaw, RBI planers into power feed sander. \$69.95. Owens Tool, PO Box 35186A, Kansas City, MO 64134. 1-800-346-3026, Ext. 2907.

**MUSIC BOX MOVEMENTS.** Reuge and Sankyo. 12 styles. Hundreds of melodies, accessories. Catalog, \$1 (refundable). Unicorn Studios, PO Box 370EA, Seymour, TN 37865.

**FILTER BAG FABRIC** for dust collection systems, (80-in. width, \$10/yard ppd.), bag and system design information, filter bags, \$40 ppd; custom bag quotes. Barter Enterprises, Box 102B, Prospect Harbor, ME 04669.

## PEPPER & COFFEE MILL WORKS

European quality for America's awakening taste  
For illustrated price list write:  
**Don Snyder Imports**  
P.O. Box 207, Comptche, CA 95427  
(707) 937-0300

## HINGES

50 sizes and shapes/cast bronze only  
send stamped self-addressed envelope for flyer and prices  
Custom Work Available

**ROSTAND-R.I. Inc.**  
P.O. Box 737, Chepachet, R.I. 02814

**WEST SYSTEM™** Epoxy Products, well-known for their quality and durability, have been developed to meet the requirements of today's high strength structures. Our experienced technical staff is available to assist you with your questions.



Gougeon Brothers, Inc.  
708F Martin Street  
Bay City, MI 48706  
517/684-7288  
\* Trademark of Gougeon Brothers, Inc., U.S.A.

**The Beall Tool Co.**



Introducing the Beall Wood-threader, a new and better way to cut threads in ANY kind of wood. This patented device attached to your router allows you to make perfect 1/2", 3/4" and 1" threads.

For more information write:  
541 Swans Road, N.E., Newark, Ohio 43055  
614-345-5045

**DUST COLLECTION INNOVATIONS**

...The source for dust collection plumbing...

- Y PIPE
- DAMPNER VALVES
- REDUCERS
- MACHINE HOOKUP



**WOOD WORKING PRODUCTS**

2634 Mineral Point Rd.  
Friday Harbor, WA 98250  
(206) 378-5618  
★ SEND FOR FREE BROCHURE ★

## Finishes

**SPRAY**—without mess or overspray. Incredible APOLLOSPRAY gives finest finish. Lacquers, enamels, urethanes etc. Portable. No compressor. Easy to use/clean/maintain. Save on materials. Used worldwide since 1966. Excellent for woodworking/cabinet shop. Information-brochure. East (914) 764-8448. West (714) 546-6217.



**POLYURETHANE COATINGS.** Everything you need to know, from boat bottoms to brass, colors, primers and clear. 12-page booklet, \$3. Satisfaction guaranteed. Detco, Box 1246, Newport Beach, CA 92663. (714) 631-8480.

**Swedish Wood**  
Dyes. Beautiful, brilliant colors. Inexpensive, non-toxic. \$5 for 3 samples. Professionally used. T.H.&A., P.O. Box 6004, Dept. FW, Rockford, IL 61125

**Miscellaneous**

**COMPUTER OWNERS!** Program makes bidding custom work easy! C-64, Apple, IBM. \$29.95. Visa, MC, check: BID!, Box 218, Brookston, IN 47923. (317) 563-3504.

**BRANDING IRONS.** Fast delivery, free literature. Call/write 800-237-8400, Ext. 720. BrandMark, Dept. F, 462 Carthage, Beavercreek, OH 45385. (513) 426-6843.

**BRANDING IRONS.** Names, signatures, logos, any size, design. Norcraft Custom Brands, Box 277F, So. Easton, MA 02375. Telephone (617) 238-2163 anytime.

**BRANDING IRONS** for craftsmen. Logo design. Send your ideas for quote. Heat Mark Co., Rt. 6, Box 828, Mooresville, NC 28115.

**CUSTOM BRANDING IRONS**  
DRILL PRESS or HANDHELD  
250 to 800 watts  
SEND \$1.00 FOR BROCHURE  
ENGRAVING ARTS (07) 984-8203  
P.O. Box 787  
Laytonville, CA 95454



**Fine Woodworking Slipcases**

These durable, dark blue cases protect your back issues and help keep order on your book-shelf. Each case holds at least 6 issues of the magazine and costs \$6.95 (\$20 for three, \$36 for six). Outside the U.S., add \$2.50 each (U.S. currency only).

Send order and payment to: Jesse Jones Industries, Dept. FWW, P.O. Box 5120, Philadelphia, PA 19141.

**Musical Supplies**

**LUTHIERS' SUPPLIES:** Imported tonewood, tools, varnishes, books, plans, parts, accessories, strings, cases, for violins, violas, cellos, basses and guitars. Assemble-yourself violin and guitar kits. Catalog, \$50, includes 10% discount certificate. International Violin Company, Ltd., Dept. WF, 4026 W. Belvedere Ave., Baltimore, MD 21215.

**VIOLIN, GUITAR, banjo, mandolin-making materials, accessories, books.** Catalog, \$1. International Luthiers Supply, Box 580397, Tulsa, OK 74158,

**REPAIR GUITARS?** Free 80-page catalog packed with tools and hard-to-find parts for guitars, banjos and mandolins. Stewart-MacDonald, Box 900F, Athens, OH 45701. (614) 592-3021.

**Plans & Kits**

**WATERBEDS AND BEDROOM FURNITURE CATALOG** of plans, \$2.75. Over 50 beautiful selections! Kraemer Furniture Designs, PO Box 33, 1350 Main St., Plain, WI 53577.

**WHITTLERS—CARVERS**  
Whittling kits with our famous 3-D scale models, pre-cut wood blanks and carving knives. Also "Strong Silent Type" materials.  
Send stamp for FREE brochure.



WOOD IS GOOD CO. FW  
BOX 2470, Santa Cruz, CA 95063

**PINOCCHIO DOLL**  
Excellent Money Maker  
Two Feet Tall  
Full Size, Pattern  
**\$8.95**  
Lloyd & Mary's Wood Creations  
7200 Cherry Brook  
San Antonio, TX 78238



**DEMONSTRATION MECHANISMS**—Precut parts kits for cams, eccentrics, scotch yokes, etc. Illustrated data sheet. SASE to Craftworks, Box 804, Soquel, CA 95073.

**UNIQUE OAK CHAIR, plans, \$1.** Kits available. Randy Ross, RR 4, Box 399A, Butler, MO 64730.

**Publications**

**LEARN FROM EXPERTS**  
Assemble beautiful varied woods for new projects in woodturning  
**POLYCHROMATIC ASSEMBLY FOR WOODTURNING.**  
113 pp. Spiral bound. Includes plans and projects.  
\$15.95 ppd. Order today or call toll free  
1-800-345-4447 (CA 209-227-2901).  
Linden Publishing  
3845 N. Blackstone, Fresno, CA 93726

**THE HOME SHOP Machinist**  
A bi-monthly magazine with plans/instructions for metal-working projects you can build. \$18.50 per year. Check or charge card—call anytime.



**THE HOME SHOP Machinist**  
800-824-7888 Operator 660 or write  
The Home Shop Machinist, Box 1810-D2  
Traverse City MI 49685  
MONEY-BACK GUARANTEE

**CLAMPS MAKE THEM YOURSELF**  
Complete detailed instructions with detailed drawings to show you how to make your own clamps & save 80% of retail price.  
20 page book \$5.00  
EDWARD HERKNER  
1211 E. Franklin, Boise, ID 83712



**Shop Space**

**WELL-EQUIPPED WOODWORKING SHOP** available to share. Experienced craftsmen only. Contact David Flatt, 72 Berry St., Brooklyn, NY 11211. (718) 388-2500.

**Tools**

**RESTORED MACHINERY** - Finest wood-working machines ever made. Oliver, Yates, Northfield. Bandsaws, table saws, wood lathes, etc. Puget Sound Machinery. (206) 627-0802.

**SHAPER CUTTERS, save 50%, buy direct** from manufacturer. Free offer. Corob, 53 Westwood, Shrewsbury, MA 01545.

**WOODEN HAND PLANES.** Take pride in these beautiful yet truly professional tools. I'll send you an informative booklet on how to choose, use and care for these fine tools. Send \$2; Dusty Splinters, PO Box 3204, Flushing, NY 11386. (718) 366-4525.

**BEST FOR LESS.** Woodworking machinery combinations. Henry Wiegand Corp., since 1924, PO Box 831, Claremont, NH 03743.

**TOOLS—ANTIQUE AND USED—STANLEY.** Quality, older hand tools for collectors and woodworkers. Current illustrated list, \$1.25. Subscription, \$5/yr., 5 lists. Bob Kaune, 511 W. 11th, Port Angeles, WA 98362. (206) 452-2292.

**SPRING SPECIALS.** Porter-Cable 690 router, \$119; 330 sander, \$52.50; 505 sander, \$102.50; 360 dustless sander, \$165. Pony 3/4-in. pipe clamps, \$7 each. Please call or write for our other low prices. Woodworker's Equipment and Supply, 566 Danbury Rd., New Milford, CT 06776. (203) 354-2219.

**OLD TOOLS FOR WOODWORKERS** and collectors. Large variety and supply of quality old tools on hand. Send \$5 for our next pictured catalog offering approximately 400 tools for sale. Bud Steere, 110F Glenwood Dr., N. Kingstown, RI 02852.

**NEW WOODWORKING CLAMP.** Ideal for edge joining, butcher blocks, and so forth. Only glue required. Fast/easy. Prohibits bowing. Pat. pend. Free information, Mark Products, Box 46143, Dept. AC4, Bedford, OH 44146.

**WOODTURNERS! CANADA'S SOURCE** for Henry Taylor Tools, the Multistar Chuck and Conover Lathe is Treen Heritage Ltd., Box 280, Merrickville, Ont., K0G 1N0. (613) 269-4251. Catalog, \$1.

**JOINERS, SHAPERS, SAWS.** Top quality. Low price. Free info. Owens Tool, PO Box 35186A, Kansas City, MO 64134. 1-800-346-3026, ext. 2907.

**SUPER PRICES ON DELTA CARBIDE TIP BLADES AND SHAPER CUTTERS.** Send \$1 for catalog, includes many other fine accessories for your shop. Satisfaction guaranteed. Visa and MasterCard accepted. Keim Lumber Co., Charm, OH 44617. (216) 893-2251. Ohio, (800) 362-6682. Mon.-Thurs. 7:30-5:00; Friday, 7:30-8:00; Saturday, 7:30-11:30 a.m. Closed Sundays.

**SPRING SPECIALS: SAMCO WOOD LATHES 1HP, 1PH,** with stand for \$575, FOB Philadelphia, PA. Dewalt 6-in. and 8-in. hollow ground dado sets with a 3/4 in. bore and a 1/8 in. width of cut. The 6-in. sets are \$19.99 and the 8-in. sets are \$29.99 delivered to your home. Also on special this month is the Delta #46-140 1/2-in. wood lathe with open stand and 1/2HP motor for \$399 or the Delta #37-290 4-in. jointer with open stand and 1/2HP motor for \$399 delivered. Carpenters Machinery is also your General Machinery outlet. So do it now! Write to Carpenters Machinery Company, 212 N. 11th St., Philadelphia, PA 19107. Attn: Wm. Murphy.

**ENGLISH ANTIQUE CAST STEEL WOODWORKING CHISELS.** Ibbotson, Ward, Mathieson, Marples, Sorby, Addis, etc. Individual chisels and sets. Pattern-makers paring chisels, carving, mortise, flat firmers and firmer gouges. Finest quality, clean, ready-to-sharpen, and guaranteed. Picture catalog, \$1. Heritage Chisels, RR1 Box 41, York, ME 03909. (207) 363-7924.

**JAPANESE TOOLS SINCE 1888.** Free catalog. New location. Tashiro's, 1435 South Jackson, Seattle, WA 98144. (206) 322-2671.

**OHIO WOODWORKERS—INCA, Freud, Foredom—hand tools, books, and more.** Woodcrafters Supply Co., 20 Arcadia, Columbus, OH 43202. (614) 262-8095.

**VIRUTEX 0-81, \$295. Biscuits, \$27 ppd.** Authorized dealer for INCA, Konig, Sand-Rite, Lignomat, Freud, Leigh. We use these machines daily in our custom furniture shop. Financing, leasing available. Precision Woodworking Machines, Route 7A, Manchester Village, VT 05254. (802) 362-1985.

**SEATTLE**  
You'll find a large selection of the best woodworking tools at:  
**The Wooden Boat Shop**  
1007 NE Boat St., Seattle, WA 98105  
(206) 634-3600  
9 AM-5:30 PM weekdays  
9 AM-5:00 PM Saturday

**Over 300 Router Bits**  
Over 300 Different Carbide Router Bits and 150 Carbide Tipped Saw Blades. From 7" to 16", designed and manufactured for the professional woodworking trade. Our quality and prices are unbeatable. Send \$2.00 for illustrated catalog.

**Nimrod Tools**  
P.O. Box 54  
Cedarhurst, N.Y. 11516

**Toolhaus CORPORATION™**  
MC • VISA • COD (617) 449-4756  
50 Brook Rd., Needham, MA 02194  
Add \$2 Shipping to order.

**\$69.99** **NOBEX 202**  
Swedish Miter XTRA BLADES—  
\$7.45  
12TPI, 18TPI, 24TPI

**JIG SAW BLADES REVERSE CUTTING**  
5/\$4

**HAND SCREW KITS** 16"-\$10.95  
14"-\$8.95 10"-\$5.25 8"-\$4.95 6"-\$4.25  
2 ea. handles, threaded rods, nuts & pins. no Jaws

**Woodworkers Super Catalog**  
Three pounds, 704 pages of tools, materials & machines, 60,000 items, valuable reference, Name Brands Discounted, call for our price before buying any machine Ph.607-729-6511  
Send \$5 or credit card to get your catalog  
**McKILLIGAN SUPPLY**  
FWC 586, Johnson City, N.Y. 13790

*We now carry*  
**Ashley Iles**  
London Pattern Chisels and Gouges  
Send for our free catalog.  
P.C. English Enterprises, Inc. Dept. FW6  
906 Lafayette Blvd., P.O. Box 7937  
Fredericksburg, VA 22404 (703) 371-1306

Versatile and accurate INCA power tools are now available in Canada through Lee Valley Tools. Write for information to:  
**INCA**  
Lee Valley Tools Ltd.  
Dept. FW52  
2680 Queensview Drive  
Ottawa, Ontario  
Canada K2B 8H6  
613-596-0350  
or come in to one of our stores for a demonstration. Stores are located in Ottawa, Toronto and Vancouver. Machines available include 10" table saw, shaper, 20" bandsaw, 10 1/2" bandsaw, 8 1/2" jointer with optional thickener, and automatic planer.  
**Lee Valley TOOLS LTD**

**Whittling and Carving Tools and Supplies**  
New catalog—60¢. American and foreign made quality tools.  
**WARREN TOOL CO., INC.**  
Rt. 1, Box 14-AF, Rhinebeck, NY 12572 (914) 876-7817



**HOCK** HANDMADE KNIVES

FOR YOUR COMMITMENT TO QUALITY

18650 MITCHELL CREEK DRIVE, FORT BRAGG, CA 95437

**ELU**

Woodworking machines, accessories, parts and service.

Exclusive U.S. Distributor - **E.B.D., Inc.**

1939 E. Aurora Rd., Twinsburg, OH 44087

Call for Dealer in your area. (216) 425-3137

**EXPERT WELDED RECONSTRUCTION ENTIRELY OF CAST IRON**

STRAIGHTNESS RETAINED

DAVID BRADSTREET Phone: (208) 273-9958

708 South Bank Rd. Oakville, WA 98668

### Toy Plans/Kits

**MAKE WOODEN TOYS—PROJECTS.** 100's plans, kits, hardwood parts, (toy, craft, furniture), tools, wood, supplies. Color catalog, \$1. (614) 484-4363. Cherry Tree Toys, Belmont, OH 43718-0369.

**CLASSIC WOODEN TOYS, plans, parts, wheels.** Catalog, \$1. Wood Classics, Box 389F, Everson, WA 98247.

**Make Peanut Butter Toys**

Plans, Hardwood Parts, Catalog \$1. Peanut Butter Toys, Granite Road, Ossipee NH 03864

**CREATE AN HEIRLOOM**

with **TOY DESIGNS**

CATALOG OF PATTERNS & TOYMAKERS SUPPLIES \$150 (U.S. dollars)

**TOY DESIGNS, P.O. BOX 441F, Newton, Iowa 50208**

### Wood Parts

**DOWELS - PLUGS - PEGS**

Largest & finest selection Oak, Walnut, Hickory, Maple, Cherry, Mahogany, Teak, even Treated Dowels. Quantity discounts.

**MIDWEST DOWEL WORKS, INC.**

4631 Hutchinson Road Cincinnati, Ohio 45248 (513) 574-8488

Catalog on request \$1.00

### Wood

**EXOTIC AND DOMESTIC HARDWOODS, veneer, marine plywood, Baltic birch, basswood to 4" thick.** 90 woods in stock. Northwest Lumber Co., 5035 Lafayette Rd., Indianapolis, IN 46254. (317) 293-1100.

**EXOTICS.** Lumber, logs, squares. Direct importer. Blackwood, tulipwood, cocobolo, Brazilian rosewood, bocote, pink ivory, kingwood, ebonyes. Desert ironwood, quilted and burl maple, lilac burls, lignum (plane sole blanks available), other species. SASE for list. SJW, 650 St. John, Pasadena, CA 91105. (818) 441-1067.

**CHESTNUT SPECIALISTS.** Custom milled. Woods of Heavenly Valley, Plymouth, CT 06782. (203) 283-4209 after 8 p.m.

**HARDWOOD PLYWOODS.** Ash, Baltic birch, red, white or natural birch, cherry, mahogany, maple, knotty pine, red oak, white oak, walnut, teak. All items 1/4 in. and 1/2 in. thickness. Sheet sizes 4x8, 2x8, 4x4, 2x4 or precision cut (1/8 in. tolerance) to any size, paying for what you order. Edging for all species in hardwood veneer strips or hardwood molding 1/4 in. by 1/4 in. Sheets of hardwood veneer with polyester backing. Wholesale quantity discounts. Call (617) 666-1340 for quotations. Shipping in USA via UPS or a common carrier. Boulter Plywood Corp., 24 Broadway, Somerville, MA 02145.

**EAST MOUNTAIN HARDWOODS, Rte. 7, Box 31H, Sheffield, MA 01257.** Select oak, cherry, maple, ash, butternut, walnut, mahogany, tulip, pine, plank flooring, butcher block, hardwood plywood. Custom milling. Toll Free, Mass. 1-800-551-5028; Northeast, 1-800-521-2019.

**HARDWOODS FROM HONDURAS.** Special: \$5 rosewood. Mahogany, cedar, roseta, teak (additional species available). 4/4 and 8/4 surfaced and rough-sawn. Large widths and lengths available. Exquisite hand-carved interior and exterior doors. Hardwood flooring and molding available. Also hardwoods from Africa and Brazil by special request. Rancho Bonita Hardwoods, 6200 San Miguel Rd., Bonita, CA 92002. (619) 267-7975.

**KENTUCKY HARDWOODS, Box 127, Fredville, KY 41430.** Custom sawn red/white oak. Walnut, various hardwoods, turning squares, kiln-dried and planed.

**COCOBOLO, BOCOTE, LIGNUM VITAE,** western yew, sitka spruce, cedar (red and yellow). A & C Hutt Enterprises Ltd., 15861 32nd Ave., Surrey, B.C. V4B 4Z5. (604) 536-7778.

**GENUINE WALNUT FLOORING,** moldings, and boards. Flooring is tongue and groove, 3/4 inch, in custom widths. This is the same beautiful walnut used in furniture with interlating character markings. Write Tom McMillan, Frank Purcell Walnut Lumber Company, Inc., PO Box 5115, Kansas City, KS 66119.

**OSAGE ORANGE—**the American exotic—beautiful saffron color with red streaks. Available in logs, boards, turning squares. Special offer! 50 lb. box shorts and turning sections, \$49.95 plus shipping. Reliance Industries, Inc., PO Box 129, Richland, IA 52585. (319) 456-6030.

Sawmill Kiln

Hardwoods Exotics

**Willard Brothers Woodcutters**

300 Basin Rd., Trenton, N.J. 08619

Call (609) 890-1990

**CONSTANTINE'S**

**Wood Center of Florida**

Exotic woods in veneers, lumber. Hard-to-find woodworking tools, hdwe. specialties, wood finishes. Catalog at store. Come on in.

1040 E. Oakland Pl. Blvd. 305-Ft. Lauderdale, FL. 33334 561-1716

**Quarter Sawn White Oak**

Precision Band Sawn. Extra Wide Stock. EXOTIC AND DOMESTIC LUMBER

Personalized Service — (215) 775-0400

RD#3, Box 303, Mohnton, PA 19540

**TALARICO HARDWOODS**

**KILN-DRIED HARDWOOD LUMBER—**exceptional! Red/white oak, cherry, mahogany, poplar, white ash, black walnut. Write for price list. Fine Hardwoods, Inc., PO Box 2120, Wilton, NY 12866. (518) 587-8641.

**ATTENTION: FLORIDA WOODWORKERS**

We have Florida's largest selection of exotic and native hard and soft woods, table slabs, veneers, etc. for the professional and novice. Send SSAA for list.

**HENEGAN'S WOOD SHED**

7760 Southern Blvd. (FW) West Palm Beach, FL 33411

Call (305) 793-1687

**Unicorn Universal Woods Ltd.**

SPECIALTY FOREIGN & DOMESTIC HARDWOODS-SOFTWOODS-VENEERS

Mail Orders

Write for 'New' Price List-Still Free

4190 Steeles Ave. W. Unit 4 Woodbridge, Ont., Canada, L4L 3S8

416-861-2308

**America's Importer of Honduras Rosewood**

DOMESTICS/IMPORTS/EXOTICS

FIGURED MAPLE/PADOUK

**Black Mountain Hardwoods**

PO Box 3525, Portland, Me. 04104

(207) 772-3352

**WESTERN PENNSYLVANIA WOODWORKERS**

50 Domestic & Imported Woods

Veneers • Finishes • Mouldings • Hardware

Carving Stock • Inlays & Bandings

Plans • Books • Magazines • Quality Tools

Call or Visit Our Store

**WOODCRAFTERS' SUPPLY**

7703 Perry Hwy. (Rt. 19)

Pittsburgh, Pa. 15237 (412) 367-4330

**EBONY, CURLY MAPLE, ROSEWOOD, MAHOGANY, & MOTHER OF PEARL**

FOR MUSICAL INSTRUMENTS.

POOL CUES, KNIFE HANDLES

For Price List EXOTIC WOODS CO.

Box 32, Dept. FW

Haddon Hts., NJ 08035 609/546-2903

**LONGSTOCK LUMBER & VENEER**

FINEST GRADES OF DOMESTIC & EXOTIC LUMBER & VENEERS

WRITE FOR FREE BROCHURE OR CALL:

440 PHILLIP ST. UNIT 21

WATERLOO, ONT. CANADA N2L 5R9

519-746-0941

**VENEER**

★ HIGHEST QUALITY ★ FULLLENGTH

★ LARGE SELECTION

★ LOWEST PRICES

"Let us show you why we're North America's fastest growing veneer supplier."

RETAILOR WHOLESALE

*certainly wood*

Write for free brochure or call.

11753 Big Tree Road, East Aurora, N.Y. 14052

(716) 655-0206

**GILMER WOOD CO.**

503 • 292-4182

**Rare & Exotic Woods**

- in logs, planks & squares
- over 50 species in stock
- also cutlery, turning & musical instrument woods

10426 NW Laidlaw Rd., Portland, OR 97229

**California Woodworkers-Restorers**

Your source for: *exot c veneers, hardwoods, inlays, tools, hardware, moldings, craft books, finishes, cane, etc.*

Exclusive suppl er of **Constantines of New York, quality products.**

**Constantines Wood Products, Inc.**

5318 W. 144th St., Lawndale, CA. 90260

(L.A. area) 213-643-9484

### WOOD & TOOL EXCHANGE

Limited to use by individuals only

#### For Sale

Antique wooden planes for sale. \$1 for list. Rick Rubin, W. 1421 16th, Spokane, WA 99203. (509) 624-9354.

Red oak FAS, AD 3 yrs. in barn, 3-8" wide. \$1.60/ft. rough; \$1.75/ft. S2S. Minimum, 100 ft. J. Houck, Temple, NH. (603) 878-2385.

Two Rockwell model 13 planers with bases, 3HP, 3PH motors. Never used, \$2,500 each. (305) 752-6456 evenings.

Old woodworking tools. Stanley and others. Send SASE for list. John Wells, 1162 Grizzly Park, Berkeley, CA 94708.

5 ft. dia. by 9 ft. V-crochted walnut log and stump. 1/2 log cut into crotch figured slabs full length/width by 2 1/2 in. thick. Will custom saw remainder of log and stump. \$4/bd. ft. Larry Conti, (206) 692-2831. Bremerton, WA.

Delta/Rockwell 12-in. gap bed lathes with stand and safety shield. Like new. \$725. (717) 245-2423.

Two Delta/Rockwell 12-in. disc sanders, no motor \$285; one with motor \$400; both excellent. Parts for stroke sander \$300 made by Devine. J. Bergama, RD 2 Box 921, Bethel, VT 05032. (802) 234-9673.

Yates 12-in. jointer, 4 blade, 5HP, SP. Bandsaw, 36-in. SP or 3PH. Chas. M. Hitchcock, Rt. 1, Box 231A, Newport Center, VT 05857.

Spalted maple lumber, squares and bowl blanks. Showpiece quality. AD. \$2.50/bd. ft. and up, FOB. 3/bd. ft. sample, \$10 ppd. L. Mullins, Box 342, Baileys Harbor, WI 54202. (414) 854-4470 for information.

Fiddleback koa guitar sets cut from koa stumps. Exceptional figure and colors. Also quartersawn stumpwood slabs. D. Degenhart, PO Box 291, Lake Montezuma, AZ 86342.

Hegner Multimax-2 with lots of blades, patterns and lettering, \$625 plus shipping. Record combination plane, \$85. Dovetail plane, \$55. Scrub plane, \$25. Don Johnson (312) 289-9756.

3PH, 5HP motor for Powermatic 66 saw. Used one year. Excellent condition, \$350. (215) 582-4800

Quality, prime white oak, kiln-dried, rough, 2,500 bd. ft., 2 1/2 in. thick by 10 ft. lengths. Call (216) 673-6736. F. Corso, PO Box 75, Brady Lake, OH 44211, near exit 13 on Ohio Turnpike.

South Bend Model A lathe 9 in. by 30 in. between centers. Motor, bench and accessories. Excellent. \$1,250. SASE for list of parts. Don Thibault, 12 Fuller Dr., Hudson, NH 03051.

20-in. woodplaner, 15-year-old Parks; knife attachment; can ship. (203) 633-2383 wk. days; (203) 649-7098 nights. \$3,000.

Spindle sanders: State \$1,125; Boice Crane, \$950. Knife grinder for 18-in. Delta planer, \$400. Lee Backulich, (614) 471-7782 evs.

**CALL US FOR PRICES ON POWERMATIC AND DELTA MACHINES**



We offer Powermatic 10" Table Saw, Model 66 Complete with: 48" Rails Single Phase 3 H.P. 230v Magnetic controls New Post-track fence

**\$1595 FOB McMinnville, TN.**  
For Biesemeyer fence add \$99.  
Model 26 shapers from \$1650.  
Miss. residents add 6% tax.

Before you buy, call us toll-free (800) 821-2750. Ask for Tools Dept. In Miss. (800) 321-8107.

**SPECIAL NET PRICES**  
Prepaid in U.S.A on Freud carbide tipped blades and cutters

LU73M010-10" x 60T Gen. Purpose ATB	\$ 35.00
LU72M010-10" x 40T Gen. Purpose ATB	34.00
LU85M010-10" x 80T Super Saw ATB	62.00
LU84M011-10" x 50T Combination 4 & R	37.00
EC-090 Cabinet Moulding Set	182.00
EC-091 Cove & Bead Set	182.00
EC-260 3/4 stock, Stile & Rail Set	159.00
EC-202, EC-209, EC-210, EC-211, EC-212 or EC-213 Raised Panel Cutters	79.00

**Addkison**  
HARDWARE CO. INC.

(601) 354-3756  
126 E. Amite St., PO Box 102, Jackson, MS 39205

**We Will Beat ANY Advertiser Price in this Magazine plus Free Tools or Accessories with Every Order**

**Buffalo Imported**  
6 x 48 Belt & Disc sander only  
6" Jointer only  
8" Jointer only  
14" Wood Bandsaw shaper



**4.5 Amp Magnum Hole-Shooter**

All ball and roller bearing. Trigger speed control with reversing switch. Exclusive brush cartridge system lets you change brushes in less than 1 minute.



**6012HDW 2-Speed Cordless Drill w/Batteries & Case**

List \$178

Quality Investment  
**DELTA 10" CONTRACTORS' SAW**



**MODEL 34-410**

\*Large 40" x 27" table with extension wings \*24 hp capacity R or L of blade \*Lifetime-lubricated ball bearing construction \*Jet Lock self-aligning rip fence \*See-thru blade guard \*Up-front controls \*UL listed

**Imported**

**MODEL 0234-1**

**with FREE RYOBI JIGSAW**



**RYOBI 10" PLANER**

**RYOBI BAND SAW**

The wide 4" belt operates at 1148 R.P.M. for fast stock removal. Powerful 8.5 amp motor for heavy-duty production use. Well balanced for control. Ball and needle bearing construction for long life. Double insulated.

**MODEL 9401**

**We Carry**

Delta, Rockwell, Milwaukee, Porter Cable, Makita, Ryobi, Skill, Bosch, B&D, Cutawl, Freud, Walker, Turner Part etc.



(215) 627-0178  
(215) 925-6139  
(215) 238-9577

**SWANGER BROTHERS**  
METAL AND WOOD WORKING  
116 N. 3rd Street, Philadelphia, PA 19106

**NOTE:** Due to the fact that we don't have an 800 number we will give you twice the amount of your call in merchandise.

**step up to Makita Power Tools**

FULL LINE DISTRIBUTOR

**8" LONGBED JOINTER**  
Model 2020, 59" bed - 4-3/8" x 31-1/2" fence.  
List \$1700  
**NOW \$899**

**12" PLANER/JOINTER**  
Model 2030 - 2 hp  
Single ph - 115V  
List \$1980  
**NOW \$1195**

**FREE FREIGHT - LIMITED OFFER**

**12" PLANER/JOINTER**  
Model 2030N - 2 hp - 7000 RPM - List \$2160  
**NOW \$1339**

**15-5/8" PLANER**  
Model 2040 - 2 hp - single ph - 115V - List \$1780  
**NOW \$1149**

FACTORY AUTHORIZED SERVICE

**acme Electric**

**TOOL CRIB OF THE NORTH SINCE 1948**

CALL TOLL FREE FOR MIKE  
**1-800-358-3096**

**22 1/2° OCTAGON GAUGE**



TO SET MITER TO SAW BLADE FOR 22 1/2° CUT. HARDENED ALUMINUM GAUGE HAS OCTAGON FORMULAS AND 14" RULER SCREENED ON. ALSO SCREW CHECKER AND INFORMATION.

**\$7.95** Plus \$2.00 Handling and Shipping

California residents add 6% sales tax. Send check or money order to:

**LYON ELECTRIC COMPANY, INC.**  
P.O. BOX 81303 SAN DIEGO, CA 92138

**HORTON BRASSES**

Nooks Hill Road, P.O. Box 120F  
Cromwell, CT 06416  
(203) 635-4400



Mfrs. of  
**Fine Hardware for Over 50 Years**  
Send \$2.00 for a catalogue

**LIKE OWNING YOUR OWN LUMBER-YARD!**

**NEW SOLID STATE ELECTRONIC CONTROLS!**

**FREE 30-DAY TRIAL**

Just a twist of the dial gives you from 70 to over 1,000 cuts-per-inch!

**Made in U.S.A.**

**Makes you money... saves you money!**

New 4-in-1 power-feed shop planes, molds, joints, sands! Quickly converts low-cost rough lumber into high-value finished stock! Turns out perfect picture frame, quarter-round, casing, tongue & groove...all popular patterns...any custom design. Planes or joints without change-over. Converts in just minutes to a powerfeed drum sanding machine! This one low-cost power-feed shop opens up a truly astonishing range of products you can make and sell. Find out how you can try this versatile tool in your own shop on our 30-day Free Trial! Easy terms.

**PHONE TOLL-FREE 1-800-251-4888**

**SEND FOR FREE FACTS TODAY**

Woodmaster Tools, Inc.  
Dept. PE38, 2908 Oak  
Kansas City, MO 64108

**YES!** Please rush my FREE Information Kit and details on your 30-Day Free Trial Guarantee.

Name \_\_\_\_\_  
Address \_\_\_\_\_  
City/State \_\_\_\_\_ Zip \_\_\_\_\_



Listings are free, but restricted to bappenings of direct interest to woodworkers. Our July/Aug. issue will list events between June 15 and Sept. 15; deadline May 1. Our Sept./Oct. issue will list events between Aug. 15 and Nov. 15; deadline July 1.

**CALIFORNIA: Workshops**—Woodworking for women, beginners and advanced, traditional furnituremaking, focus on handtools. Contact Debey Zito, 103 Wool St., San Francisco, 94110. (415) 648-6861.

**Conference**—Art, culture, future: American Craft '86, June 4-7. Oakland Museum, Kaiser Convention Center, Laney College. Registration deadline May 15. Contact ACC Conference project office, PO Box 30756, Oakland, 94604.

**Juried show**—California State Fair - California Works, all media. Entry deadline May 30. Fair dates Aug. 15-Sept. 1. For prospectus and entry form write California State Fair, California Works, PO Box 15649, Sacramento, 95852 (916) 924-2015.

**COLORADO: Workshops**—Furniture design, Peter Korn, June 16-27; furniture construction, Art Carpenter, June 30-July 11; style, James Krenov, July 14-25; chairs, John Nyquist; veneering, Silas Kopf; furniture, Sam Maloof, July 26-27; furniture techniques, Tage Frid. Anderson Ranch Arts Center, Box 5598, Snowmass Village, 81615. (303) 923-3181.

**Juried exhibition**—Sanctify Through Beauty, through June 20. Mizel Museum of Judaica, 560 South Monaco Parkway, Denver, 80224: (303) 333-4156.

**CONNECTICUT: Workshops/exhibition**—Numerous classes, through June 1. Northeast birdcarving II, through May 18. Brookfield Craft Center, Inc., PO Box 122, Brookfield, 06804. (203) 775-4526.

**Classes**—Numerous classes, Jun. 22-Aug. 31 Brookfield Craft Center, Brookfield/SoNo Craft Complex. Contact Brookfield Craft Center, Inc., PO Box 122, Brookfield, 06804 (203) 775-4526.

**Juried exhibition**—29th Annual Crafts, sponsored by Guilford Handcrafts, Inc., July 17-19. Contact 29th Annual Guilford Handcrafts Expo, PO Box 221, 411 Church St., Guilford, 06437. (203) 453-5947.

**Exhibition**—53rd annual spring conference, May 6-7. Central Conn. State University, New Britain. Contact Cheryl A. Reynolds, (203) 526-9303.

**Juried show**—10th annual SONO arts celebration, Aug. 2-3. Entry deadline June 15. Contact Paula Mae Green, SONO Arts Celebration, Box 2222, Norwalk, 06852. (203) 853-6155.

**Juried exhibition**—18th Annual Celebration of American Crafts, Nov. 10-Dec. 23. Invitational, deadline July 15. Write Roz Schwartz, Creative Arts Workshop, 80 Audubon St., New Haven, 06511.

**DELAWARE: Exhibition**—14th Annual Crafts Fair at the Delaware Art Museum, June 7. Registration deadline May 23. Delaware Art Museum, 2301 Kentmere Pkwy., Wilmington, 19806. For registration form and information contact Lial A. Jones (302) 571-9594.

**DISTRICT OF COLUMBIA: Juried exhibition**—1986 Washington Craft Show, Apr. 18-20. Departmental Auditorium, 1301 Constitution Ave. NW, Washington. (202) 357-4000.

**Symposium**—Living with Wood, Apr. 19. Speakers: Paul Bertorelli, Wendell Castle, David Ellsworth. Carmichael Auditorium National Museum of American History, Constitution Ave. at 13th St. NW., Washington. Contact Judith Coady, (202) 686-5262.

**Exhibition**—Masterpieces of Time: Clocks by Wendell Castle, through May 4. Renwick Gallery, National Museum of American Art, Smithsonian Institution, Pennsylvania Ave. at 17th St. NW, Washington.

**FLORIDA: Workshop/exhibition**—David Ellsworth, May 21-25. Spotlight '86, May 23-June 22. University Gallery. Contact Ray Ferguson, College of Education, University of Florida, Gainesville, 32611.

**Exhibition**—Woodsculpture, Mark Lindquist, May 2-31. Netsy Gallery, 3107 Grand Ave., Coconut Grove, 33133.

**ILLINOIS: Seminars**—Table saw, routers, finishing, May 12-17. Woodworking Lab, Still Hall 103, Northern Illinois University, DeKalb, 60115. (815) 753-1457.

**Juried exhibition**—7th annual Fountain Square Arts Festival, June 28-29. Contact Evanston Chamber of Commerce, 807 Davis St., Evanston, 60201. (312) 328-1500.

**Workshops/demonstrations**—Tools, carving, finishing, techniques, through Apr. 26. The Hardwood Connection, 420 Oak St., DeKalb, 60115. (815) 758-6009.

**Workshops**—Furniture conservation, July 7-25. Campbell Center, PO Box 66, Mount Carroll, 61053. (815) 244-1173.

**INDIANA: Juried show**—Wood furniture, modern, classic, traditional, Sept. 1-Oct. 12. Entry deadline May 15. Chesterton Art Gallery, 115 South 4th St., Chesterton. Contact Marsha Demkovich, Chesterton Art Gallery, PO Box 783, Chesterton, 46304. (219) 926-3041.

**Juried exhibition**—Madison Chautauqua of the Arts, Sept. 27-28. Deadline July 1. Vine St. near Lanier Mansion, Madison Chautauqua of the Arts, c/o Dixie McDonough, 1119 West Main St., Madison, 47250.

**Seminar**—Furniture and cabinet manufacturing, June 9-12. Registration limited. Purdue University Campus, West Lafayette. Contact Dr. Daniel Cassens or Vicki Taylor, Dept. of Forestry and Natural Resources, Purdue Univ., West Lafayette, 47907. (317) 494-3633 or 494-3644.

**IOWA: Workshop**—Furniture construction, July 21-Aug. 1. Contact Northeast Iowa Technical Institute, Box 400, Calmar, 52132. (319) 562-3263.

**KANSAS: Juried exhibition**—Topeka crafts competition 10, through May 4. Gallery of Fine Arts Topeka Public Library, 1515 W. 10th, Topeka, 66604. (913) 233-2040.

**Juried show**—2nd annual Lenexa, 3-dimensional art, May 2-4. Sar-Ko-Par Park (87th St. Pkwy at Lackman Rd.), Lenexa. Contact William H. Nicks, Jr., Show Director, City of Lenexa, PO Box 14888, 12350 West 87th St. Pkwy, Lenexa, 66215.

**KENTUCKY: Show**—Sponsored by High Country Crafters, Inc., May 9-11. Heritage Hall, Lexington Center, Lexington. Contact High Country Crafters, 29 Haywood St., Asheville, N.C. 28801. (704) 254-0070.

**Juried exhibition**—Kentucky Guild of Artists and Craftsman's 25th anniversary, July 25-27. Water Tower, Louisville. Contact KGAC 25th Anniversary, Water Tower Art Assoc., 3005 Upper River Rd., Louisville, 40207. (502) 896-2146.

**Exhibition**—National wood invitational, sculptured and turned wood, May 19-June 12. LoHo Gallery, 414 Baxter Ave., Louisville, 40204.

**Symposium**—Woodturning/joinery, Sanford Hill, Eral Kindel, Jim Hall; June 5-7. Contact Jim Hall CPO 758, Berea College, Ind. Arts Dept., Berea, 40404. Office: (606) 986-9341, ext. 347; home: (606) 686-8083.

**MARYLAND: Juried shows**—11th annual spring arts and crafts, Apr. 18-20. Montgomery County Fairgrounds, Montgomery. 9th annual spring crafts festival, May 2-4.

## THE WOODWORKING SHOW

machinery  
tools—supplies



**SEE THE WIDEST VARIETY OF WOODWORKING PRODUCTS ALL UNDER ONE ROOF**

— 100 EXHIBITS —  
MACHINERY • POWER & HAND TOOLS • SUPPLIES

★ FREE Workshops ★ Door Prizes

Seminars by James Krenov—Ian Kirby—Michael Dunbar and other Master Craftsmen

**May 2-3-4, 1986**  
Arlington (Texas) Conv Ctr.

**Sept. 26-27-28, 1986**  
Michigan Exposition & Fairgrounds

**Nov. 21-22-23, 1986**  
San Jose Conv. & Cultural Ctr.

**Oct. 10-11-12, 1986**  
Minneapolis Auditorium & Conv. Hall

**Oct. 31-Nov. 2, 1986**  
Seattle Center

**Bring this ad and save \$1 OFF the regular admission price of \$5.**

**1-800-826-8257**  
Call for further information

**MAKITA • PORTER CABLE • ROCKWELL • BOSCH • LION**

**HILLER HARDWARE CO.**  
**DELTA BLADE GUARANTEE**  
"TRY ONE FOR 30 DAYS — IF YOU DON'T LIKE IT FOR ANY REASON, SEND IT BACK FOR A FULL REFUND."

**50% OFF ▲ DELTA 10" CARBIDE BLADES**

MODEL#	DESCRIPTION	DELTA LIST	HILLER PRICE
35-617	10x50 Tooth Combination "Your First Blade To Buy"	78.25	39.12
35-612	10x24 Tooth ATB General Purpose Rip/Crosscut	68.10	34.05
35-619	10x60 Tooth (-6° Hook)*	94.10	47.05
35-625	10x80 Tooth (-6° Hook)*	123.05	61.50

\*Delta Negative (-6°) hook angle blades are designed for use on radial arm saws and mitre boxes where cutting action is contrary to work feed. Super smooth cutting - helps take the "BIND" out of your radial arm saw - great for plastics and non-ferrous metals too!!!  
A REVOLUTIONARY BLADE (available 8", 9", 10" & 12").

(NOTE: THESE PRICES INCLUDE DELTA COUPON DISCOUNT)

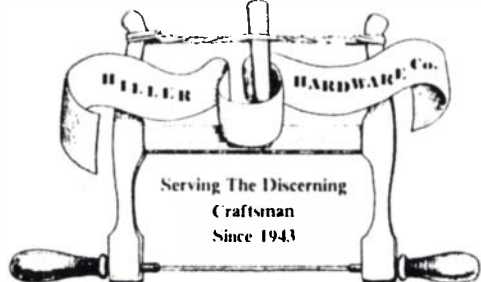

Serving The Discerning  
Craftsman  
Since 1943

**1411 ASSEMBLY STREET, P.O. BOX 1762  
COLUMBIA, S.C. 29202-1762  
803-779-3131 EXT. 10**

● WRITE FOR NEW FALL-WINTER CATALOG  
● VISA, MASTERCARD ACCEPTED

**HEGNER • STANLEY • GREENLEE • HENCKELS • MERIT**

# WOODWORKER'S CATALOG



There are over 3,000 money-saving reasons why woodworkers rely on Constantine.

3,000 woodwork items—to help you **Build-Restore-Repair-Refinish!** Over 200 different woods... 150 veneers... 500 plans... cabinet hardware... 96 How-To Books... 118 carving tools and chisels... 76 inlay designs... and lots more for **One Stop, Right-Price Shopping** without leaving home!

**CONSTANTINE** Est. 1812  
2065M Eastchester Road, Bronx, NY 10461

Professional Discounts Available  
116 Page Catalog—Only \$1.00  
\$2.00 refunded on 1st order.

## MEMPHIS HARDWOODS OF LITTLE ROCK NASHVILLE

### "FINE WOODS & TOOLS"

Over 60 species of Hardwoods. Both Native & Exotic.  
Quality Hand & Power Tools. Veneer. Plywood. Books.  
Carving Blanks. Turning Squares. Bits & Blades.

**SPECIAL** While Supplies Last, **DELTA SCROLL SAW**  
#40-601. PREPAID PRICE - \$950.00

DELTA MAKITA RYOBI HITACHI PORTER-CABLE INCA FREUD A.M.I.

The Complete Woodcraft Supply Store! HM

A Division Of Cockroft Lumber Company - COLCO  
1-800-321-5239  
BOX 12449 MEMPHIS, TN 38182-0449

# PARKS OUTSTANDING NEW MODEL 98 12" THICKNESS PLANER

## MADE IN AMERICA

• Compact • Ready-To-Run

Classic design and construction features: cast iron structure, steel feed and bed rollers, ball bearing cutterhead, micro blade adjustment.

**SPECIAL PARKS FEATURE:**  
"Full Power" 2 H.P. motor permits deep 1/8" cut on widest boards.

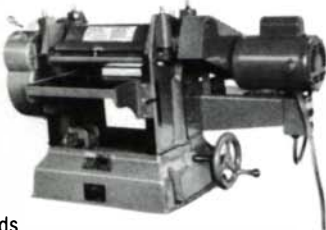

FOR LATEST CATALOG AND PRICES CALL 513-681-1931

**THE PARKS WOODWORKING MACHINE CO.**  
Dept. FW 1501 Knowlton St., P.O. Box 23057, Cincinnati, OH 45223



## Sleeveless DRUM SANDER

NO PRE-MADE SLEEVES TO BUY

**ECONOMICAL** — Simply cut sandpaper from standard size sheets  
**UNIQUE** — Twist of key tightens sandpaper to drum.  
**SPONGE RUBBER** backing insures long wear of sandpaper

**AVAILABLE WITH:**

1/2" Bore with 1/2" or 3/4" shaft	1" x 3" long	\$13.50
1/2-20 RH Thread except 3/4" x 3"	2" x 3" long	\$15.50
3/4" Bore except 3/4" x 3" and 2" x 3"	2 1/2" x 3" long	\$16.00
	3" x 3" long	\$17.50



1" and 2 1/4" Above \$27.00  
Above 4 Drums \$55.00

3/4" x 3" long	\$14.50
2 1/2" x 4 1/2" long	\$21.00
3" x 4 1/2" long	\$22.50
2 1/2" x 6" long	\$25.50
3" x 6" long	\$27.50

Add \$2.50 Per Order For Shipping

**USE ON:**  
Drill Press  
Small Motor  
Lathe, Combo-Tools,  
Radial Saw, 1/4" Drill

## SINGLEY SPECIALTY CO. INC.

P.O. BOX 5087F, GREENSBORO, N.C. 27403  
CALL: (919) 852-8581

# ART CULTURE FUTURE

AMERICAN CRAFT '86

## A NATIONAL CONFERENCE

Sponsored by the American Craft Council. Distinguished speakers, panels, papers, exhibitions, demonstrations and more.

**JUNE 4-7, 1986**

This summer in Oakland, California, 1,000 art, craft, and design professionals will come together to assess the status of the crafts movement in the '80s and the viability of crafts in the coming decades.

Write or call today:

**ACC CONFERENCE**  
P.O. Box 30756  
Oakland, CA 94604  
415-272-0600

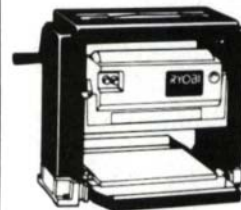

## 10" THICKNESS PLANER

\$399.00 Postpaid

Ryobi's new 10" auto-feed thickness planer is a breakthrough in compact design and affordability. It weighs just 58 lbs., yet handles material up to 10" wide and 5" thick. Exceptionally smooth finish. Powered by rugged 13amp 120v motor. Knife setting gauge allows quick, accurate adjustment of knives. All ball bearing construction. One year warranty.

Spare set of knives . . . \$30.00 Postpaid.

## MAKITA 9820-2 BLADE SHARPENER

\$195.00 Postpaid\*

Sharpens planer and jointer knives with great speed and accuracy. Medium grit Japanese waterstone rotates in gravity-fed bath for safe work on your edge tools.

New **GREEN WHEEL** for 9820-2. 120-grit coarse silicon-carbide wheel re-shapes bevels and grinds out nicks; also sharpens carbide knives . . . \$35.00 Postpaid.

\*SPECIAL thru June 30, 1986 **FREE GREEN WHEEL** with purchase of 9820-2

Optional Accessory Jig (shown in use in photo) for sharpening chisels and plane irons . . . \$12.50 postpaid.



## LAMELLO PLATE JOINTER

\$550.00 Postpaid

Patented design and Swiss precision make the Lamello Top the fastest and most accurate plate jointery tool on the market. Positions instantly for rapid assembly and maximum joint strength. One year warranty.

Lamello Jointing Plates (boxes of 1000) . . . \$27.50 postpaid.  
Specify size 0 (9/16" wide), 10 (3/4" wide) or 20 (15/16" wide).

MC/Visa users outside Georgia  
**ORDER TOLL FREE**  
**(800) 241-6748**  
(Orders Only)

Or send check, money order, or MC/Visa info to Highland Hardware. Prices are postpaid in 48 adjacent U.S. Offers effective through June 30, 1986. SEND \$1.00 for our tool catalog and newsletter subscription (free with order).



1045 N. Highland Ave. NE Dept. F  
Atlanta, GA 30306 (404) 872-4466

Maryland State Fairgrounds. Contact Deann Verdier, Sugarloaf Mountain Works, Inc., Ijamsville, 21754. (301) 831-9191.

**Exhibition**—Artscape '86, juried, outdoor, July 18-20. Mid-Atlantic states. SASE to Crafts, Artscape '86, c/o MACAC, 21 S. Eutaw St., Baltimore, 21201. (301) 396-4575.  
**Juried show**—23rd Annual Havre de Grace Arts & Crafts, Aug. 16-17. Tydings Park. Deadline July 15. Contact Havre de Grace Arts & Crafts Show, PO Box 174, Havre de Grace, 21078. (301) 879-4404.

**MASSACHUSETTS: Workshops/seminars**—Numerous events. Contact The Woodworkers' Store, 2154 Massachusetts Ave., Cambridge. (617) 497-1136.

**Workshops**—Woodworking for high school students, summer sessions. Horizons: The New England Craft Program, 374 Old Montague Rd., North Amherst, 01002. Contact Jane Sinauer, (413) 549-4841.

**Workshops**—Cabinetmaking, May 5-9, finish carpentry, June 2-6, numerous housebuilding. Heartwood School, Johnson Rd., Washington, 01235. (413) 623-6677.

**Show**—Dollhouse and miniatures Aug. 17. Sponsored by The Cape Cod Miniature Society. Dunfee's Hyannis Resort, West End Circle, Hyannis. Contact Angela J. Goodwin, Dealer Co-ordinator, PO Box 98, Kent Rd., So. Harwich, 02661. (617) 432-2840

**Exhibition**—Scent bottle invitational, July 1-Sept. 3. Signature Stores, Inc., Village Market Place, Stevens St., Hyannis, 02601; Dock Square, North St., Boston, 02109. Entry deadline Apr. 1. Contact Gretchen Keyworth, Karen Garland.

**Exhibition**—Small Works in Wood, John Reed Fox, Robert McKeown, Peter Petrochko, Cho Il-Sang, Merryl Saylan, May 9-June 14. The Society of Arts and Crafts, 175 Newbury St., Boston, 02116, (617) 266-1810.

**Demonstration/workshop**—Making a Windsor chair, Apr. 19-20. Harmon Road Hand Woodwork, Peter Murrett, Joiner, Monterey, 01245. (413) 528-3454.

**Juried show**—16th annual craft, May 16-18. Worcester Craft Center, 25 Sagamore Rd., Worcester, 01605. (617) 753-8183.

**Juried show**—7th Annual Fair of Traditional Crafts, Nov. 1 & 2. Application deadline June 1. Contact Frank G. White, Old Sturbridge Village, Old Sturbridge Village, Sturbridge, 01566. (617) 347-3362 ext. 236.

**MINNESOTA: Workshops/seminars**—Numerous events. The Woodworkers' Store, 3025 Lyndale Ave. S., Minneapolis (612) 822-3338.

**Workshop**—Woodcarving, Aug. 3-9. Villa Maria Retreat Center, Villa Maria Workshop, PO Box 37051, Minneapolis, 55431.

**MISSISSIPPI: Juried show**—3rd annual international crafts festival, May 30-June 1. Coast Coliseum, Biloxi. Contact Eileen Za, Gulf Coast Coordinator, 1000 Washington Ave., Ocean Springs, 39564. (601) 875-3900.

**MISSOURI: Show**—Woodworking World - Kansas City, May 2-4. Kansas City Market Center, Executive Park, Kansas City. Contact W.A.N.A., PO Box 706, Plymouth, N.H. 03264. (603) 536-3876.

**MONTANA: Exhibition**—7th annual student/faculty exhibition, May 23-June 1. Contact Steven Voorheis, Primrose Center, 401 West Railroad, Missoula, 59802. (406) 728-5911

**NEW HAMPSHIRE: Workshops**—13th annual violin and bow maker's summer institute, June 9-Aug. 1. Univ. of New Hampshire, Durham. Early registration advised. Contact Summer Violin Institute, Univ. of N.H. Continuing Education, 24 Rosemary Ln., Durham, 03824. (603) 862-1088.

**Tour**—Switzerland, two weeks, guide Wayne Barton. Sponsored by Woodworking Assoc. of North America for woodworkers and woodcarvers. Sept. 30-Oct. 14. Contact W.A.N.A., Box 706, Plymouth, 03264. (603) 536-3876.

**NEW JERSEY: Workshops**—Bending wood, handplanes, carving, making furniture, shoji, joinery and more, July 4-Aug. 29. Peters Valley Crafts Center, Layton, 07851. (201) 948-5200.

**Seminar**—Lathe and woodturning, Palmer Sharpless, Apr. 26. Brookdale Community College, Newman Springs Rd., Lincroft 07738. Contact Dr. Gabriel Longo, (201) 842-1900, Ext. 586.

**NEW YORK: Juried exhibition**—10th Anniversary American Crafts, June 28-29 and July 5-6. Lincoln Center for the Performing Arts, New York City. Contact Brenda Brigham, American Concern for Artistry and Craftsmanship, PO Box 650, Montclair, NJ 07030. (201) 798-0220.

**Juried show**—2nd annual spring fling crafts festival, May 2-4. Nassau Coliseum, Uniondale, L.I. Contact Creative Faires, Ltd., PO Box 1688, Westhampton Beach, N.Y. 11978. (516) 325-1331.

**Juried exhibition**—33rd annual national, sponsored by Mamaroneck Artists Guild, Oct. 24-Nov. 9. Community Unitarian Church, Rosedale Ave., White Plains. Entry deadline Apr. 21. Contact Open Juried Exhibition, Mamaroneck Artists Guild Gallery, 150 Larchmont Ave., Larchmont, 10538.

**Workshops**—Numerous classes through June. The Luthierie, 2449 West Saugerties Rd., Saugerties, 12477. (914) 246-5207.

**Juried exhibition**—9th annual Great Hudson River Revival, June 21-22. Croton Point Park, Croton-on-Hudson. Contact Scott and Neil Rubinstein, Quail Hollow Events, PO Box 825, Woodstock, 12498. (914) 679-8087 or (914) 246-3414.

**Juried show**—Chautauqua Crafts Festival, '86, July 4-6 and Aug. 8-10. Entry deadline May 1. Bestor Plaza, Chautauqua Institution, Chautauqua. Contact Gale Svenson, Chautauqua Crafts Festivals, '86, PO Box 89, Mayville, 14757.

**Juried exhibition**—International Art and Craft Competition, June 24. Entry deadline Apr. 30. 112th Street Gallery, 112th St., New York. Contact Metro Art, PO Box 286-H, Scarsdale, 10583. (914) 699-0969.

**Exhibition**—Objects by graduating seniors of School for American Craftsmen at Rochester School of Technology, April 17-24. Sibley's downtown Ward Gallery, Rochester. (716) 424-6109.

**NORTH CAROLINA: Exhibition/fair**—Buncombe County High School Woodworking classes display, Apr. 30-May 12. Folk Art Center, Blue Ridge Pkwy., Mile Post 382, Asheville. 39th annual guild, July 17-20. Asheville Civic Center, Asheville. Contact Blair White, Southern Handicraft Guild, PO Box 9545, Asheville, 28815. (704) 298-7928.

**Workshops**—Tools, furniture, techniques, design, turning, June 2-Sept. 19. Penland School, Penland, 28765. (704) 765-2359

**Workshops**—Japanese woodworking, July 14-18; Scandinavian woodenware, July 28-Aug. 1; Greenwood chairmaking, Aug. 18-22; White oak basketry with Darryl Wood, Sept. 1-5. Contact Drew Langsner, Country Workshops, 90 Mill Creek Rd., Marshall, 28753. (704) 656-2280.

## SUNHILL

### SDM-37 36" Cabinet Shop Wide Belt Sander

- Single Platen Head
- 37" x 60" belt
- 15 HP main motor
- 1 HP feed motor
- Single phase option Available

LIST - \$12,000

**SALE - \$8,950**

\* We stock a full line of wide belts from 24" to 48" with prices starting at \$5,850



### SP-101 Cabinet Shop Shaper

- \* The most popular model in our complete line of shapers!
- Single phase 2 HP motor
- Precision 1" spindle
- 2 3/8" spindle travel
- 2 reversible speeds
- Options include 3 HP motor, 1/2", 3/4" and 1 1/4" spindles; Collets for router bits

List - \$1600

**SALE - \$1195**



### CT-200 8" Cabinet Shop Jointer

- Single Phase 2 HP motor
- 9" x 67" table
- 6000 RPM
- 3 blade cutterhead
- Wt: 500 lbs.
- Dual Tilt fence

List - \$1350

**SALE - \$895**



### PS-20 20" Planer

- 5 HP motor
- 20" x 8" capacity
- 25' per min. feed rate
- Wt: 730 lbs.

List - \$3,500

**SALE - \$2,450**

### CT-38B 15" Planer

- Powerful 3 HP motor
- 2 speed feed rate
- 3 blade cutterhead
- Stand included
- Wt: 480 lbs.

List - \$1650

**SALE - \$1175**



### TS-10 10" Tilting Arbor Table Saw

- Single or 3 phase
- 3 HP motor, magnetic switch
- Triple V-belt drive
- 5/8" precision arbor
- T-slot table with mitre
- Milled fence with micro-adjust
- Wt: 485 lbs.

List - \$1850

**SALE - \$1357**

All machinery covered by a one year warranty. Call the dealer nearest you for information on our full line of cabinet shop and production equipment.

## SUNHILL

414 Olive Way, Dept. F  
 Times Square Building  
 Seattle, WA 98101  
 (206) 622-5775

### Contact the Dealer in Your Area:

AR (501) 524-6486	IN (219) 353-7551	NY (518) 872-0369
CA (707) 937-4280	IN (219) 825-2006	OH (614) 927-9061
CA (619) 729-2973	KS (316) 942-8475	OH (216) 878-7076
CA (408) 248-3535	KY (502) 898-3740	OR (503) 252-4335
CA (916) 343-5937	LA (504) 738-6063	OR (503) 756-7721
CO (303) 469-8013	MD (301) 340-7377	OR (503) 389-1521
CT (203) 522-8174	MI (313) 773-4406	PA (717) 632-3443
IA (319) 391-2386	MI 800-624-5395	TX (713) 683-8455
IA (319) 232-5434	MN 800-624-5395	TX (214) 826-1752
IA (515) 228-2940	MS (601) 362-9320	UT (801) 262-2020
IA (515) 782-7391	NC (704) 376-7421	WA (206) 775-6304
IL (312) 395-6655	NH (603) 524-8545	WA (206) 423-4242
IL (815) 758-6009		WI 800-472-5680

# PERFECT DOVETAILS IN MINUTES!

**Fool Proof. Simple. Accurate.**

Through-dovetail router templates



**KELLER Dovetails**  
Box 800 F  
Bolin, CA  
94924  
(415) 868-0560

**WOODWORKERS! SAVE up to 44% on the world's finest hand and power tools!**



I travel the world to find the finest woodworking tools at the lowest cost, so you can save and work with the best. Some are available only from me. All have a 90-day money-back guarantee. And if you can find the same product for less at any other mail order company, I'll return the difference you paid plus 10% of the price! Call 1-800-243-1037\* for your catalog TODAY! Both the call and the catalog are FREE! \*In CT, call 797-0772

**The Fine Tool Shops, Inc. Dept FWJ6**  
20 Backus Avenue,  
Box 1262, Danbury, CT 06810

## Full Size Plans



### Oak Ice Box

Easy to build using our full size plan. The hinged top is optional for bar compartment. We also supply hinges, latches & casters. 32 x 17 x 34 high.

**ICE BOX PLAN**  
Plan-337 ..... \$10.50  
**HARDWARE**  
Hinges/latches \$42.00  
Casters (4) \$12.50  
Shipping \$ 3.00  
NY Res. add tax

Ice Box Hardware

Catalog \$1.00—Free with plans. Phone (516) 462-6228  
We accept Visa & MasterCard orders if over \$15.00

ARMOR, Dept. D, Box 445, E. Northport, NY 11731

## MOVING?

Don't miss an issue of *Fine Woodworking*. Just fill out and return this form at least six weeks before you move. Or call 1-800-243-7252 (in CT, 426-8171).

Old Address:

Name \_\_\_\_\_

Address \_\_\_\_\_

City \_\_\_\_\_ State \_\_\_\_\_ Zip \_\_\_\_\_

New Address:

Address \_\_\_\_\_

City \_\_\_\_\_ State \_\_\_\_\_ Zip \_\_\_\_\_

The Taunton Press  
63 South Main Street, Newtown, CT 06470

## 18th Century Furniture Kits

The original, and the largest manufacturer of authentic museum quality reproduction furniture kits in solid cherry, ash and mahogany.



Free Sale Catalog Call 1-800-BARTLEY or in Illinois 634-9510

- CHAIRS
- TABLES
- CHESTS
- LOWBOYS
- and MORE!

*The Bartley Collection, Ltd.*  
747 Oakwood Ave., Dept. FW791  
Lake Forest, IL 60045

*This is a Japanese hand carved ink line (sumitsubo) made of Keyaki wood, with a bamboo brush (sumisashi).*

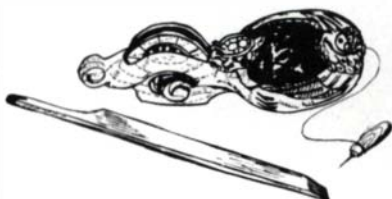

Many sizes, prices range from \$25 to \$150

You can draw a line finer than a piece of hair with it.

Japanese carpenters cut the center of the line with a saw.

We import tools directly from Japanese craftsmen.

New Catalog will be out soon \$3.00



**HIDA JAPANESE TOOL CO.**  
1333 San Pablo Ave.  
Berkeley, CA 94702  
(415) 524-3700

## EXCALIBUR 24 • EXCALIBUR II Make The Precision Decision

To Order Call Toll Free 1-800-387-9789



**EXCALIBUR 24<sup>®</sup>**  
c/w 1/4 Hp Var. Speed Motor & HD Stand

SHIPPED UPS PREPAID  
**\$ 1350.**  
NO OTHER CHARGES

Excalibur 24's are working to exacting standards in industrial and commercial settings in schools and other institutions, and in the homes of dedicated hobbyists across the country.

### Excalibur Precision Scroll Saws At-A-Glance

	Excalibur 24	Excalibur II
Throat . . . . .	24"	19"
Cutting Depth Maximum . . . . .	2 1/2"	2"
Length of Cutting Stroke . . . . .	14"	12"
Cutting Speed . . . . .	6-1800*	1400 Single-800 speed 400 motor*
		6-1800 variable-speed motor*
Worktable adjustment Right . . . . .	30"	45"
Left . . . . .	45"	43"
Worktable Width . . . . .	14"	12"
Worktable Depth . . . . .	24"	17 1/2"
Overall Length . . . . .	33"	37"
Overall Width . . . . .	20"	12"
Overall Height . . . . .	21"	14"
Weight . . . . .	110 lbs	45 lbs
*Rpm (strokes/minute)		

SHIPPED FREIGHT COLLECT  
**\$495.**  
NO OTHER CHARGES

**EXCALIBUR II**  
Less Motor & Switch

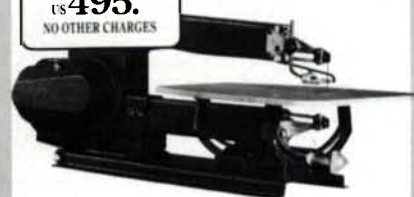

The budget-respecting Excalibur II accepts any motor to become the true craftsman's dream with features unparalleled at its price.

SEND FOR OUR CATALOG OF OTHER FINE WOODWORKING MACHINES



**J. Philip Humfrey International**

3241 Kennedy Road, Unit 7  
Department FW5/6  
Scarborough, Ontario M1V 2J9 (416) 293-8624

I enclose \$1.00 (refundable against purchase). Please rush my catalog.

Name \_\_\_\_\_

Address \_\_\_\_\_

City \_\_\_\_\_ State \_\_\_\_\_ Zip \_\_\_\_\_

**OHIO: Workshop**—Woodbending techniques, William Keyser, May 17-18. Center for Wood Design and Craftsmanship, University of Akron, 150 East Exchange Street, Akron, 44325. (216) 375-7575.

**Workshop**—Equipment Maintenance and Repair, common woodworking machinery and tools, June 9-14. College of Technology at Bowling Green State University, Bowling Green. Contact BGSU Office of Continuing Education, (419) 372-8181.

**Juried exhibition**—Contemporary woodworking, sponsored by Dairy Barn Southeastern Ohio Cultural Arts Center, Athens, Sept. 12-Oct. 12. Entry deadline June 15. Contact American Contemporary Works in Wood, PO Box 747, Athens, 45701. (614) 592-4981.

**OKLAHOMA: Show**—10th annual national woodcarving, July 11-13. Kensington Galleria, 7130 South Lewis, Tulsa. Contact Robert Hughes, 2204 S. 132 E. Ave., Tulsa, 74134. (918) 664-9991, 437-1474.

**OREGON: Workshop**—Bentwood woodworking, Seth Stem, July 7-11. Register early. Oregon School of Arts and Crafts, 8245 SW Barnes Rd., Portland, 97225. (503) 297-5544.

**Show**—Rose Festival Woodcarving Show, May 31-June 8. The World Forestry Center, 4033 S.W. Canyon Rd., Portland, 97221. (503) 228-1367.

**PENNSYLVANIA: Exhibition**—Wharton Esherick, sculpture, furniture, utensils, daily. The Wharton Esherick Museum, PO Box 595, Paoli, 19301. (215) 644-5822.

**Juried show**—8th Annual Longs Park Art and Craft Festival, Aug. 30-Sept. 1. Contact Dick Faulkner, Longs Park Art and Craft Festival, PO Box 5153, Lancaster, 17601.

**Juried exhibition**—Market House '86, 5th annual, sponsored by Conestoga Valley Chapter, Penn. Guild of Craftsmen, May 4-25. Market House Craft Center, Queen and Vine Sts., Lancaster, 17604. (717) 295-1500.

**Juried exhibition**—20th annual sidewalk sale Central Pennsylvania Festival of the Arts., July 10-13. Campus of Penn State, State College. Contact Central Pennsylvania Festival of the Arts, P.O. Box 1023, State College, 16804. (814) 237-3682.

**Show**—14th annual volunteers antiques, May 23-26. Brandywine River Museum, Brandywine Conservancy, PO Box 141, Chadds Ford, 19317. (215) 388-7601.

**Seminars**—Woodfinishing, George Frank, May 9-11; cabinetmaking, Will Tillman, June 21. Olde Mill

Cabinet Shoppe, Box 547A, RD#3, York, 17402. (717) 755-8884.

**Classes**—Basic woodcarving, June 30-July 4. Sawmill Center for the Arts, Cook Forest State Park, Cooksburg. Contact Sawmill Center for the Arts, PO Box 6, Cooksburg, 16301.

**Workshops**—Traditional joinery, handtools, Jasper Brinton, Bob Harrington, Michael Burgoon, May 15-July 17. Contact Brinton Studio, Western Road, RD 2, Phoenixville, 19460. (215) 935-2851.

**Show**—New work, Ed Zucca, May 4-June 21. Snyderman Gallery, 317 South St., Philadelphia, 19147. (215) 238-9576.

**Juried exhibition**—Contemporary crafts, Oct. 4-Nov. 2. Entry deadline June 14. Luckenbach Mill Gallery, Historic Bethlehem, 501 Main St., Bethlehem, 18018. (215) 691-5300.

**Juried exhibitions**—Crafts 20, June '86. Museum of Art, Pennsylvania State University. Sculpture and sculptured object, July 7-Aug. 1. Zollar Gallery, Pennsylvania State University. Entry deadline for both Apr. 10. Send SASE to Sculpture or Crafts 20, Central Pennsylvania Festival of the Arts, Box 1023, State College, 16804.

**Show**—Woodturning, Nick Cook, June 16-21; Japanese Joinery, Robert Meadow, July 19-20; Furniture Design and Construction, Tom Merryman, July 28-Aug. 6. Contact Touchstone Center for Crafts, PCC, PO Box 2141-W, Uniontown, 15401. (412) 438-2811.

**RHODE ISLAND: Show**—Wooden boat show, Aug. 21-24. Newport Yachting Center, Newport. Contact Abby Murphy (401) 846-1600.

**SOUTH DAKOTA: Juried show**—15th annual show, July 12-13. Contact Brookings Summer Arts Festival, Box 555, Brookings, 57006.

**TENNESSEE: Workshops**—Woodcarving, Lockhart; woodturning, Nish, Osolnik, Doyle, Ellsworth, Sakwa; furniture construction, Osgood, June 9-Aug. 15. Arrowmont School of Arts and Crafts, Box 567, Gatlinburg, 37738.

**Exhibition**—Faculty and staff exhibition, mixed media, May 30-Aug. 15. Bob Lochart, Dale Nish, Rude Osolnik, Jere Osgood, Leo Doyle, David Ellsworth, Hap Sakwa. Contact Debbie Johnson, Arrowmont School of Arts and Crafts, Box 567, Gatlinburg, 37738. (615) 436-5860.

**VIRGINIA: Juried show**—Annual hand crafts, Oct. 24-26. Radisson Hotel, Lynchburg. Entry deadline

June 6. Contact Lynchburg Fine Arts Center, 1815 Thomson Dr., Lynchburg, 24501. (804) 846-8451.

**Juried exhibition**—11th annual Richmond Craft Fair, Nov. 7-9. Hand Workshop, 1812 West Main St., Richmond, 23220. Entry deadline June 1. Contact Hand Workshop (804) 353-0094.

**WEST VIRGINIA: Juried exhibition**—Mid-Atlantic woodworking, functional, sculptural, Jun. 22-Aug. 24. Oglebay Institute, Stifel Fine Arts Center, 1330 National Rd., Wheeling, 26003. (302) 242-7700.

**WISCONSIN: Class**—Lumber drying, Paul Bois, Apr. 23-24. Richardson Brother's Co., Sheboygan Falls. Contact Paul Bois, 27 Mondale Ct., Madison, 53705. (608) 238-7097.

**BRITISH COLUMBIA: Exhibition**—Explorations in Wood, May 2-29. McPherson Playhouse, Victoria. Contact Vancouver Island Woodworkers Guild, PO Box 6584, Station C, Victoria, V8P 5N7. George Dufour, (604) 387-0376.

**Show**—Freeform woodturning, functional, sculptural, Jason Marlow, July 2-Aug. 29. Seymour Art Gallery, 1204 Caledonia Ave., North Vancouver V7G 2A6. (604) 929-7981.

**ONTARIO: Exhibition**—Summer Treasures; Summer Pleasures III, woodcarvings by Daniel Griffith, Jun. 21-Aug. 30. Heritage Crafts, Sheridan Mews, 182-186 King St. West, Brockville, Ontario K6V 5Y4.

**Show**—Annual May show, May 10-11. Sheridan College, School of Crafts & Design, Lorne Park Campus, 1460 S. Sheridan Way, Mississauga, Ontario. (416) 274-3685.

**Classes**—Series for new and experienced craftspeople, Jun. 30-Aug. 8. Sheridan College School of Crafts & Design, Lorne Park Campus, 1460 S. Sheridan Way, Mississauga, Ontario, L5H 1Z7. Contact Betty Kantor (416) 274-3685.

**SASKATCHEWAN: Conference**—Make a Chair from a Tree, John D. Alexander; Totem carving, Keith Matheson; sculpture, Prairie Sculptures Association, Aug. 8, 9, 10. Contact Saskatchewan Craft Council, Box 7408, Saskatoon, Saskatchewan S7K 4J3. (306) 653-3616.

**AUSTRALIA: Seminar**—2nd international woodturning, Brisbane, June 7-9. Contact John Anderson, 14 Bilsand St., Tarragindi 4121, Queensland.

## Full-Size FURNITURE PLAN 18th Century PINE CRADLE

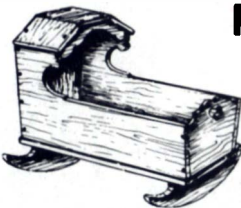

Authentic 18th Century design. All joints hand-pegged like the original. 36" long by 29 1/4" high. Perfect for fireplace wood, magazines. Baby, too! A woodworker's delight!

Order plan #120 .. \$8.00

CATALOG  
180 diff., full-size prof.  
furniture plans—\$2.00  
(catalog free with order)

FURNITURE DESIGNS, Dept. KP-56  
1425 Sherman Ave., Evanston, Ill. 60201

"IF YOU BUY A  
**GENERAL**  
WOODWORKING  
MACHINE  
SOMEWHERE  
ELSE YOU'LL  
PROBABLY PAY  
TOO MUCH."  
J. Philip Humfrey

Every General machine receives and is shipped with Humfrey's all-points inspection report.

CALL TOLL FREE 1-800-387-9789

#350 10" Table Saw <b>\$1345.</b> US FREIGHT COLLECT	#1180-1 6" Jointer <b>\$765.</b> US FREIGHT COLLECT
3 HP motor, Magnetic switch	1 HP motor, Manual switch
#160-2 Variable Speed Lathe <b>\$1095.</b> US FREIGHT COLLECT	#490-1 15" Bandsaw c/w Base <b>\$845.</b> US FREIGHT COLLECT
1 HP motor, Manual switch	1 HP motor, Manual switch

SIMILAR SAVINGS ON OTHER GENERAL MACHINES

J. Philip Humfrey Ltd.

We sell more General year after year - the reason is value - we satisfy our customers!

VISA CATALOG \$2.00 (Refundable from order) MasterCard

## Brand Your Work

Personalize your wood and leather products or handicrafts with the easy to use Craftmark™ Branding Tool. Choose from four branding marks: Logo-Maker's-Owner's-Custom

For more information write:  
**Wall Lenk Corporation** Department F 58  
P.O. Box 3349, Kinston, North Carolina 28502-3349

## FREE Tool Catalog

### Quality Products For Woodworkers

Send today for your FREE copy of our new colorful catalog. It's fully illustrated with the finest quality tools, supplies, books, components, hardware, and much more. Satisfaction Guaranteed. Write today for your FREE catalog.

**WOODCRAFT SUPPLY CORP.**  
Dept. FW56  
41 Atlantic Avenue, Box 4000  
Woburn, Massachusetts 01888

## RECAINE for fun and profit

Recane or re-rush heirloom chairs - for yourself or for others as a profitable hobby - with our full line of materials & instruction books.

Since 1934 America's largest selection of caning & basketry materials & supplies -

- Superior quality weaving cane & machine woven cane
- Flat, oval & round reeds
- Fibre & genuine rush
- Danish seat cord
- Raffia, rattan, seagrass
- Hoops & handles

Illustrated catalog with complete how-to-do-it information, prices, order form: \$1 (refundable with 1st order)

## CANE & BASKET SUPPLY CO.

1283 S. Cochran, Dept. FW, Los Angeles, CA 90019



# QUALITY PLUS BIG SAVINGS!



**Makita**  
Mitre Box with  
dustbag and vise  
LS1000  
LIST \$348.00  
**SALE**  
**\$209.95**

## Makita

Order No.	Description	LIST	SALE
2030*	12" planer/jointer	1980	1395
1805B	6" planer	416	265
1900BW	3" planer kit	154	90
2040*	15" planer	1780	1179
1100	3" planer kit	278	160
6800DBV	Drywall driver	123	89
5007NB	7" circular saw	158	100
JR3000V	Recipro saw	178	120
5402A	16" circular saw	468	315
3700B	Laminate trimmer	124	85
3612BR	Plunge router	286	180
6510LVR	3/8" VSR drill	114	69
6012HDW	Cordless drill kit	178	100
DP3720	3/8" VSR drill	88	55
DP4700	1/2" VSR drill	154	95
9030	1 1/8" x 21" belt sander	185	125
9401	4" x 24" belt sander	279	160
9501	4" sander/grinder kit	119	87
9900B	3" x 21" belt sander	198	120
9924B	3" x 24" belt sander	204	135
9924DB	3" x 24" dustless belt sander	214	135
B04510	Finishing sander	79	44
9045N	Dustless finishing sander	156	105

## Metabo

Order No.	Description	LIST	SALE
EP564	VS barrel-jig saw	239	186

## BLACK & DECKER

Order No.	Description	LIST	SALE
3157	VS orbital jigsaw	178	120
3051	7/16" worm drive saw	232	140
3052	8 3/4" worm drive saw	247	170
3102	2-speed cut saw	156	93
3107	Cut-Saw*	188	130
2034	2500 rpm drywall Scrugun*	123	82
2037	4000 rpm drywall Scrugun*	146	91
3030	7 1/4" circular saw	159	99
3047	7 1/4" circular saw	232	150
3048	8 1/4" circular saw	246	159
4008	Palm grip sander	76	50
4247	4 1/2" grinder	105	68
1179	3/8" VSR Holgun* drill	116	70
1311	1/2" VSR Holgun* drill	157	104
1920	Reversible cordless drill	160	115
1980	reversible adjustable clutch cordless drill	179	129

## VIRUTEX

Order No.	Description	LIST	SALE
081	Plate jointer	335	299
Plate #0		31	28
Plate #10		32	28
Plate #20		33	28
AU93	Veneer hand trimmer	20	18
U78	Veneer sheet trimmer	140	130

## RYOBI

Order No.	Description	LIST	SALE
TS-251U	10" mitre saw with carbide blade	411	230
XZ300	Vise, holder, bag kit for TS-251U	20	20
TS380	14" mitre saw	550	375
AP-10	10" portable thickness planer	659	425

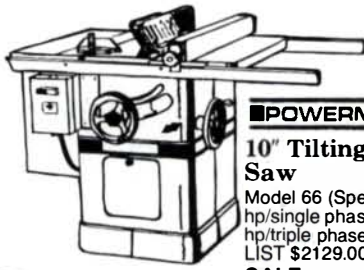

## POWERMATIC

### 10" Tilting Arbor Saw

Model 66 (Specify either 3 hp/single phase or 5 hp/triple phase motor)  
LIST \$2129.00  
**SALE**  
**\$1825.00**

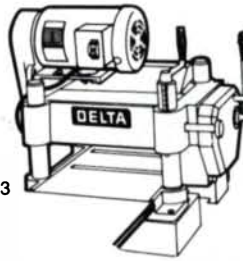

**DELTA**  
RC-33 13" Planer  
22-651  
LIST \$1729.00  
**SALE**  
**\$995.00**

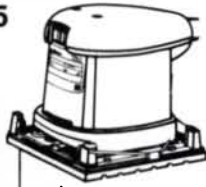

**BLACK & DECKER**  
Palm Grip Sander  
4008  
LIST \$76.00  
**SALE**  
**\$50.00**

## DELTA Super Savings!

Order No.	Description	LIST	SALE
46-541*	Wood lathe with accessory package	2771	1399
46-140*	11" wood lathe	551	430
34-150	UNIFEEDER stockfeeder	574	199
34-155	Unifence adapter kit for 34-150	50	20
43-150	Shaper adapter kit for 34-150	199	95
34-781*	10" UNISAW 1 1/2 hp	1784	1499
34-782*	10" UNISAW 3 hp	2081	1850
34-783*	10" UNISAW 5 hp	2081	1850
34-784*	10" UNISAW 5 hp	2081	1850
34-172	Tenon attachment for UNISAW	215	169
34-010S	9" mitre saw	231	170
15-091*	15" floor model drill press	486	375
15-231*	15" step-pulley drill press	1101	940
15-331*	15" V* drill press	1243	1062
23-650	6" bench grinder	173	139
23-750	7" bench grinder	283	240
23-850	8" bench grinder	330	282
28-243/62-142*	1/2 hp bandsaw	717	562
28-243/62-246*	3/4 hp bandsaw	818	645
28-283*	3/4 hp bandsaw	933	699
22-651*	RC-33 13" planer	1729	995
50-651*	Stand for RC-33	276	225
22-460*	20" planer 7 1/2 hp	4667	3990
22-461*	20" planer 5 hp	4667	3990
22-600*	24" planer 7 1/2 hp	6496	5554
22-602*	24" planer	10990	9310
22-610*	24" planer	6700	5725
33-150*	Sawbuck* frame & trim saw	707	519
31-730/52-611*	Finisher	1384	1180
33-890*	12" radial arm saw	1367	1050
33-990*	10" radial arm saw	606	469
34-621/52-493*	9" builder's saw	710	539
34-410/62-042*	10" contractor's saw	1032	699
34-429*	10" tilting arbor saw	1193	899
34-790*	14" tilting arbor saw	3933	3365
34-889*	10" scoring saw 3 hp	2950	2595
34-890*	10" scoring saw 5 hp	2950	2595
34-794*	14" panel saw	6109	5225
37-420*	16" precision jointer	4657	3980
37-220/50-290/62-247*	6" jointer	1139	975
37-220/52-891*	6" jointer	1292	1105
37-315/49-054*	8" jointer	1583	1355
40-601*	Electronic scroll saw	1074	859
50-180*	1 hp dust collector	463	369
50-181*	2 hp dust collector	658	550
43-122*	LD wood shaper	680	519
43-375*	2-speed shaper with 1/2" and 3/4" spindles	2111	1805
43-385*	2-speed shaper with 1" spindle	2111	1805
43-561*	Overarm router	2525	2158
43-780*	5-speed shaper 7.5hp	3655	2950
43-781*	5-speed shaper 5 hp	3655	2950

**CALL FOR SPECIAL PRICES ON ALL DELTA CUTTERS**

## \$100 Rebate on Delta 10" Contractor's Saw

34-410/62-042\*  
LIST \$1032.00

**SALE**  
**\$699.00**

**SALE WITH REBATE**  
**\$599.00**

## freud

Order No.	Description	LIST	SALE
LU82M010	10" x 60th general purpose TCG	86	40
LU72M010	10" x 40th general purpose ATB	69	34
LU81M010	10" x 40th general purpose TCG	69	36
LU85M010	10" x 80th super saw ATB	111	65
LU84M011	10" x 50th combination 4&R	62	39
LM72M010	10" x 24th straight line	64	39
LU85M009	9" x 72th super saw ATB	102	64
EC001	Door lip cutter	62	42
EC005	Roman ogee cutter	58	39
EC031	Rev. glue joint	60	40
EC032	Wedge tongue cutter	68	43
EC033	Wedge groove	68	43
EC034	Lock mitre set (for 3/4" spindle)	120	80
EC044	1/4 & 1/2" quait round	72	48
EC101	1/8" radius convex	50	34
EC103	5/8" radius convex	61	41
EC104	5/16" radius convex	68	46
EC105	3/8" radius convex	74	50
EC120	1/8" radius concave	54	36
EC121	3/16" radius concave	58	39
EC123	5/16" radius concave	66	44
EC124	3/8" radius concave	70	47
EC140	1/4" straight edge	44	30
EC141	3/8" straight edge	48	35
EC142	1/2" straight edge	52	38
EC143	5/8" straight edge	56	36
EC144	3/4" straight edge	60	40
EC146	1" straight edge	64	43
EC202	5/8" stock raised panel	122	82
EC209	3/4" stock raised panel	122	82
EC210	3/4" stock raised panel	122	82
EC211	3/4" stock raised panel	122	82
EC212	3/4" stock raised panel	122	82
EC213	3/4" stock raised panel	122	82
EC219	3/4" stock raised panel	122	82
EC240	Drawer lock cutter	64	43
EC260	3/4" stock stile & rail	246	164
EC266	1" stock stile & rail	280	187
EC270	1 3/8" stock stile & rail	280	187
EC274	1 3/4" stock stile & rail	280	187

NOTE: All saws and Dado have 5/8" bore.  
ATB = Alternate Top Bevel  
4&R = 4 Teeth & 1 Raker Tooth  
C.T. = Carbide Tipped

## GRIGGIO

Order No. Description  
SCI-3200\* Sliding panel saw

**CALL FOR COMPLETE GRIGGIO CATALOG**

## POWERMATIC

Order No.	Description	LIST	SALE
1660750TS*	10" tilting arbor saw 5 hp	2129	1825
1660760TS*	10" tilting arbor saw 3 hp	2129	1825
1680170TS*	12" tilting arbor saw 5 hp	2815	2395
1280100*	Shaper	2025	1799
1260050*	Shaper	2025	1799
1500040*	6" jointer	1188	999
1610040*	8" jointer	1870	1775
1610050*	8" jointer	1620	1499

## PORTER+CABLE

Order No.	Description	LIST	SALE
9627	Tiger saw	194	132
9629	VS electronic tiger saw		
	VS sander	194	142
7348	Bayonet saw	163	114
7548	Top-Handle jig saw	199	136
7648	Barrel-Grip jigsaw	199	139
314	4.5 amp saw	180	126
315-1	13 amp saw	166	108
346-1	12 amp saw	162	113
368-1	13 amp saw	177	123
587	14.5 amp saw	199	139
336	3x21 belt sander	180	128
337	3x21 belt sander dustless	190	133
360	3x24 belt sander dustless	280	196
361	3x24 belt sander	260	182
362	4x24 belt sander dustless	295	201
363	4x24 belt sander	280	196
503	3x24 worm gear dustless	510	357
504	3x24 worm gear	495	346
330	Finish sander	87	54
505	Finish sander	175	113
100	7/8 hp router	141	96
536	1 1/2 hp router	300	210
630	1 hp router	150	105
690	1 1/2 hp router	194	132
691	1 1/2 HP Router D-handle	218	153
537	1 1/2 hp router	315	220
518	Speedtronic router	490	343
520	3 hp router	460	314
513	HD lock mortiser	952	708
5009	Mortise & tenoning jig	50	35
9118	Porta-Plane kit	299	204
9652	Versa-Plane kit	419	293
319	Laminate trimmer	215	145
309	Laminate trimmer	130	91
310	Laminate trimmer	190	133
312	Laminate trimmer	205	143
9725	2-speed Porta-Band kit	405	277
9728	2-speed Porta-Band kit	499	341
695	Shaper table with motor	278	190
	Shaper table	150	103
696	VSR drywall driver	153	104
7540	Drywall driver	158	108
821	3/8" VSR drill	130	78
686	3/8" HD VSR drill	165	122
7514	1/2" drill	169	115
7511	3/8" pistol drill	164	112
97850	1/2" VSR drill kit	201	137

## W.S. JENKS & Son

738 7th Street NW  
Washington DC 20001

2024 West Virginia Ave. NE  
Washington DC 20002

(202) 737-7490



While Supplies Last

## FREE FREIGHT ON ALL PORTABLE MODELS!

Items marked with \* are considered non-portable. Call for prices on shipping.

TOLL FREE ORDER LINE 1-800-638-6405  
MASTERCARD · VISA · AMERICAN EXPRESS

**American Furniture in the Metropolitan Museum of Art, Late Colonial Period: The Queen Anne and Chippendale Styles** by Morrison H. Heckscher. *Published by The Metropolitan Museum of Art (5th Avenue at 82nd Street, New York, N.Y. 10028) and Random House, New York, 1985. \$45.00; hardbound, 383 pp.*

This is volume two in a series, published before the others no doubt because the Met thinks it will be the most popular (volume one will concern William and Mary; volume three will cover Federal). If all goes well with these three, there is a hint in the preface that a book on Victorian furniture may follow. Judging from the photos in this book, the Met collection is sumptuous and superb. This series will be an important one.

*American Furniture* is essentially a lavish catalog. Divided by furniture type—seating and sleeping furniture, tables, stands and screens, and so on—it presents 213 pieces. A photograph of each is accompanied by anything from a dozen to one-hundred rather dry lines of comment on the piece and its maker, followed by summaries of its provenance, construction and condition. A section of photos at the back of the book compares details of various similar pieces.

The introduction points out that trying to categorize American furniture into Queen Anne, Chippendale, or the hybrid “transitional” is frustrating and somewhat misguided. The English styles were interpreted differently in Philadelphia than they were in Boston, and the Colonies related more to the influence from overseas than to each other’s interpretations. The book often emphasizes these regional preferences, and I found the perspective, as well as the direct talk about when each center was most important, illuminating.

The Met’s book, however, does not have the compelling magic of *New England Furniture, the Colonial Era* by Brock Jobe and Myrna Kaye (reviewed in *FWW* #52, and available from the Society for the Preservation of New England Antiquities, in Boston). The many bonuses in the Jobe/Kaye book—the line drawings of molding profiles, photos of construction details, a truly engaging text—make it an outstanding effort that deserves imitation. In contrast, this book’s dry scholarship and superabundance of provenance is solid meat for professionals involved with period furniture, but for a woodworker it’s stuffing without gravy.

The 371 photographs (47 in color), most by Richard Cheek, are glorious, but I wish they’d gone a little further. For example, in addition to a number of details of desk interiors, carved finials, shells and pediments in the back of the book, there are 35 close-ups of different feet, mostly claw-and-ball. These will help collectors, but they would have been of much more interest and use if they had been shown in profile as well as head-on. Admittedly, it’s unfair to criticize this book on such grounds—after all, the furniture *is* exquisite and woodworkers aren’t the intended audience. But I found little things like that disappointing.

—Jim Cummins

**The Bark Canoes and Skin Boats of North America** by Edwin Tappan Adney and Howard I. Chapelle. *Smithsonian Institution Press, P.O. Box 4866, Hampden Station, Baltimore, Md. 21211; 1983. \$24.00 ppd.; hardbound, 242 pp.*

When Edwin Tappan Adney ran out of money in 1887 after three years at the Art Students League of New York, he decided to take a short vacation. He headed for Woodstock, New Brunswick. There he fell in with Peter Joe, a Malecite Indian who lived in a temporary camp nearby. Joe’s life so interested the 19-year-old Ohioan that he turned to learning and recording the Indian’s handicrafts. In 1889 Adney and Peter Joe each built a birchbark canoe. Adney followed and

recorded the Indian’s every step of construction, and published the results in Harper’s *Young People* magazine in 1890. As far as is known, these are the earliest detailed building instructions for a birchbark canoe. For the rest of his life, Adney assembled material, built models, and traipsed to Indian reservations to interview Indians on canoe types and construction.

Ten years before his death, Adney deposited over 100 models and a portion of his papers in the Mariners’ Museum, Newport News, Va. After his death in 1950, Adney’s son placed the rest of his papers about canoes with the museum.

Howard I. Chapelle, Curator of Transportation at The Smithsonian, naval architect and author of the classic volume on wood boat construction, *Boatbuilding*, took Adney’s unorganized notes and sketches and put this book together. Chapelle added a section on the skin boats of the Arctic, the kayak and the umiak.

The result is a fascinating and richly detailed look at a nearly lost handicraft. This sophisticated product of stone-age technology had evolved over an unknown number of generations into a highly efficient means of inland and coastal waterway transportation. The basic construction was used by different tribes all across the North American continent, but with variations to suit local conditions and availability of material.

The first Europeans in the New World were impressed by the speed, light weight, strength, and load-carrying capacity in shallow water of the bark canoe and quickly adopted the canoe for their own use. By 1750, the French had set up a canoe factory near Montreal that produced twenty 36-ft. canoes a year.

The bark canoes that the first Europeans saw were built with stone tools. The birch, elm, spruce, hickory and other barks were sewn with the root of black spruce; Northern white cedar was used for ribs, gunwales and sheathing. The cedar sheathing was formed by immersion in hot water, and the seams were waterproofed with spruce gum, the resin obtained from either the black or white spruce tree. A large measure of patience and experience, along with the knowledge of the working qualities of the materials and great skill with the available tools went into each canoe.

Possibly the arctic skin boats were even more sophisticated primitive watercraft than the canoes. Given the very limited materials available, the extreme climate and the open water and ice conditions in which they operated, they were marvels of the efficient use of material for their function.

Structurally, the canoe was a bark envelope with the wood sheathing and ribs secured by outward pressure against the bark. Remove the bark and the wood structure would mostly collapse. On the other hand, the kayak used a rigid frame over which the non-structural watertight skin envelope was loosely secured.

This book will tell you how to build these craft, what tools and materials were used, and how they were prepared for incorporation in the boat. Also discussed are the changes in construction and materials that took place as European products were introduced. Included is a chapter on the large fur-trading canoes, their development and use, how they were packed and portaged, and how they disappeared so completely that there are no remains left to study. Rare period photographs and excellent detailed drawings supplement the well-done text.

The book is properly manufactured with good-quality paper, binding and printing. If this subject grabs you at all, you will want this book.

—Roger Barnes

*Jim Cummins is an associate editor for Fine Woodworking. Roger Barnes is design director for the Taunton Press*

PROFESSIONAL QUALITY

PATENTED AND MADE IN U.S.A.

**DOWEL CRAFTER**

**THE ONLY GUARANTEED SELF-ALIGNING DOWELING JIG**

ABSOLUTE ACCURACY ASSURED. No measuring needed. Drill one or a pair of holes with only one setting and one mark. Dowel pins will always line up with flush joints. Adjustable hole spacing from 3/4" to 2" for 4 popular size dowels. Fast and easy to use. Comes equipped for optional use in your bench vise for HANDS-FREE operation.

**\$45.50** + 2.50 POSTAGE & HANDLING

CALL OR WRITE

**THE DOWEL CRAFT COMPANY**  
2542 Tartan Drive, Santa Clara, CA 95051  
Phone: (408) 246-4914 Send Check, M.D.

NEW

DEALER INQUIRIES INVITED

TEAK • EBONY • MILLWORK • DRY KILN FACILITY • BASSWOOD •

POPLAR • OAK • MAPLE • ASH • MAHOAGANY

PADOUK • BIRCH • CHERRY • WALNUT



**YUKON LUMBER CO.**

520 W. 22nd St. • Norfolk, Virginia 23517 • (804) 625-7131

Furniture and Cabinet Woods      Custom Millwork  
Boatbuilding Lumber                  Exotic Hardwoods

COCOBOLO • BUBINGA • PURPLEHEART • ROSEWOOD • WENGE •

**THE TOOL SHED** a division of BOSHCO, INC.

The Shophelper anti-kickback hold down guide. Will fit any table saw, shaper, jointer, handsaw etc. OSHA approved

Reg. \$79.50      **SALE \$69.50**

**Biesemeyer Fence Model 50.**



**Pin Router, Cast iron table, includes 3/4" motor power motor (most powerful hand held router motor on the market) with optional base can be used as hand held. Foot pedal pneumatically controls router.**

Reg. \$299      **SALE \$278**

Other models available at similar savings.

Reg. \$1140      **SALE \$999**

617-667-1911

42 Manning Rd., Billerica, MA 01821 in MA 1-800-442-4438

**What's a JOINT-MATIC 4200?**

A Joint-Matic 4200 is the unique system in joinery that is so advanced in design and simplicity that set up time has been all but eliminated.

Now in minutes make precision Mortise, Tenon, Sliding and Through Dovetails, Box Finger Joints and much much more.

For Your Brochure, Please Send \$2.00 to:

**Strong TOOL DESIGN**

20425 Beatrice  
Dept. FW • Livonia, MI 48152



**TOOL CITY**

**BEATS ANY AD PRICE THIS ISSUE**

**FREIGHT PREPAID (USA)**

**MAKITA**

ALL MAKITA TOOLS  
30-45% OFF • PHONE FOR PRICE

**HITACHI**

All Hitachi Tools  
30-45% OFF • PHONE FOR PRICE

**MILWAUKEE**

ALL MILWAUKEE POWER TOOLS  
25-40% OFF • PHONE FOR PRICE

**PORTER CABLE**

ALL PORTER CABLE POWER TOOLS  
25-45% OFF • PHONE FOR PRICE

**BOSCH**

ALL BOSCH POWER TOOLS  
25-45% OFF • PHONE FOR PRICE

**RYOBI**

ALL RYOBI TOOLS  
25-45% OFF • PHONE FOR PRICE

**AEG**

ALL AEG POWER TOOLS  
30-45% OFF • PHONE FOR PRICE

**SENCO**

All Senco Nailguns & Fasteners  
BIG DISCOUNTS • PHONE FOR PRICE

**BIESEMAYER RIP FENCES**

28" HOMESHOP \$189. 40" HOMESHOP \$199.  
52" HOMESHOP \$239. 52" COMMERCIAL \$289.  
BLADE FINDER \$119. ANGLE FINDER \$119.  
Call for other Biesemeyer Products

**FREUD**

SAW BLADE SPECIALS  
FREUD SAW BLADES 10" = 1/2"

No.	size	teeth	use	list	sale
LU72m10	10"	40	general	\$68.58	\$34.50
LU73m10	10"	60	cut-off	79.65	35.00
LU73m12	12"	72	cut-off	113.35	76.00
LU78m10	10"	80	plastic	117.02	83.50
LU82m10	10"	60	cut-off	86.40	44.00
LU82m12	12"	72	cut-off	123.36	85.95
LU84m11	10"	50	comb	74.51	37.00
LU85m10	10"	80	cut-off	110.88	62.00
LU72m10	10"	24	ripping	68.58	35.00
DS306	6"		Dado	139.00	94.00
DS308	8"		Dado	179.00	107.00

WE CARRY EVERY ITEM FREUD MAKES!  
CALL FOR BIG DISCOUNTS!

**FREUD RAISED PANEL BIT SALE**  
Reg. \$129. SALE your choice \$89.00  
EC202, EC209, EC210, EC211, EC212, EC213  
For 3/4" Stock 3/4" Bore with 1/2" bushings.

**CARBIDE TIPPED**  
6pc complete stile & rail set for 3/4" stock, 3/4" bore with 1/2" bushing.

**FREUD 15pc router bit set.** Complete with wooden case, retail price is well over \$300. ON SALE NOW \$139.

**ALL FREUD ROUTER BITS & SHAPER CUTTERS 25% OFF**

**TOOL CITY**

14136 E. FIRESTONE BLVD.  
SANTA FE SPRINGS, CA. 90670  
#5 FRY AT VALLEY VIEW EXIT  
Open Monday-Saturday 8:00 am-5:30 pm  
WE SHIP IT FAST!

OUTSIDE CA 1-800-423-7899  
INSIDE CA 1-800-826-7819  
METRO LA 213-802-1236

or personal check

**BANDSAW BLADES**  
1/2" to 3/4" WIDTHS  
5\* per INCH and a \$1.85 weld charge per blade. Because we ship prepaid, minimum order is 5 blades.

**HITACHI PLUNGE ROUTER SALE**  
Both come with \$60 worth of accessories  
HP MDL# LIST SALE  
1 TR8 \$206 \$119  
3 TR12 \$299 \$169

**RYOBI 10" Miter Saw With FREUD LU85 10X80T Teflon Blade.**  
Last Month of This Sale!  
Reg. 439. SALE 209.00  
Accessory Kit \$20.

**HITACHI F1000-A 12" planer 6 1/2" jointer combination.** 15 amp 2.7 HP 26 feet/min. list \$2100. SALE \$1239. ppd. P-100-F 12" PLANER SALE \$949. ppd.

FREE WITH ANY ORDER  
#1 PREPAID FREIGHT  
#2 2-YR SUBSCRIPTION TO TOOL CITY CATALOG

**RYOBI PLANER \$399.00**

**FREUD RAISED PANEL BIT SALE**  
Reg. \$129. SALE your choice \$89.00  
EC202, EC209, EC210, EC211, EC212, EC213  
For 3/4" Stock 3/4" Bore with 1/2" bushings.

**CARBIDE TIPPED**  
6pc complete stile & rail set for 3/4" stock, 3/4" bore with 1/2" bushing.

**FREUD 15pc router bit set.** Complete with wooden case, retail price is well over \$300. ON SALE NOW \$139.

**ALL FREUD ROUTER BITS & SHAPER CUTTERS 25% OFF**

**TOOL CITY**

14136 E. FIRESTONE BLVD.  
SANTA FE SPRINGS, CA. 90670  
#5 FRY AT VALLEY VIEW EXIT  
Open Monday-Saturday 8:00 am-5:30 pm  
WE SHIP IT FAST!

OUTSIDE CA 1-800-423-7899  
INSIDE CA 1-800-826-7819  
METRO LA 213-802-1236

or personal check

## The Tree Circus of Axel Erlandson

The woodworker's craft usually begins when the life of a tree ends. But when Axel Erlandson decided to make a chair he certainly didn't start with felled lumber. Instead, he grew it in his own backyard along with dozens of other living-tree sculptures which comprise the unique life work of a most unusual woodworker.

Born into a Swedish family that emigrated to the United States in 1885 and later started a farm in California's central valley, young Erlandson was a quick learning, patient, altruistic man with a natural gift for growing trees. After teaching himself surveying, and designing a drainage system that turned his desolate hardpan and blow-sand farm into arable land, he started his own tree nursery. He honed his horticultural skills by raising and selling cypress, cedar, pine and locust to local farmers to be used as windbreaks.

Erlandson noticed that certain trees, especially sycamores, possessed the remarkable ability to self-graft. The process, called inosculation, takes place when two branches grow against each other and, rocked by the wind, rub together until the green cambial layers beneath the bark come into contact and spontaneously grow together. Intrigued, Erlandson decided to try to bend and graft trees artificially.

His first experiments began about 1925. Planting four sycamores in a square six feet on a side, Erlandson allowed the saplings to grow to a height of eight feet. Then, using a scaffolding as a form, he gently bent them toward one another. After they reached the center, he bent them upward, pared off the bark on adja-



*Alex Erlandson's daughter Wilma was photographed with this Tree Circus con-tortionist sometime in the 1940s.*

cent surfaces, and cloth-taped them together in a process known as approach grafting. The four trees subsequently grew together at the top and so became one tree with four separate root systems. This organic pergola he called his "four-legged giant."

Once started, Erlandson expanded his repertoire of techniques as he tackled more complicated designs. He practiced interweaving the stalks or branches of a tree, encouraging grafts at the intersec-

tions. With this method, known as "pleaching," he created a huge cage-like silo structure out of eighteen separate trees. By splitting a branch lengthwise and bending the halves away from each other, he discovered he could easily make two branches out of one. Bends could be gradual, twisting, or angular, for which a wedge was cut out of a limb and the faces of the notch brought together and grafted. Not having been formally trained in horticulture, Axel had the gift of ignorance—he explored and innovated techniques without the constraints of orthodoxy.

Erlandson trained his saplings to form two-dimensional designs by strapping them down on a flat board. He created three-dimensional forms with jury-rigged supports serving as tie points for curves or changes of angle. Most of the training braces were minimal and rickety. As the tree grew larger and stronger, it tended to support itself anyway. Sometimes, when braces were left in place too long and became imbedded, they could be sawed off and the bark allowed to grow and cover up the stubs. A tree eventually hid all sign of Erlandson's manipulations, keeping the exact methods used in his organic joinery a mystery.

Erlandson had very few failures: hardly any due to shortcomings in technique. A particular form had to be more than just visually pleasing though, since living trees cannot be designed for their structure alone, like furniture can. They have their own laws of fluid dynamics and each branch lives only so long as it contributes to the livelihood of the tree. The flow of sap—a tree's vital blood—tends to take the path of least resistance and to abandon all other routes. Erlandson discovered that the growth and form of a tree could be

## Design Book photo tips

In judging the past three Design Books, we've found that many entries were rejected not because the work didn't measure up but because the photos were of poor quality. You'll improve your chances of getting into *Design Book Four*, as well as other slide-judged competitions, by following a few simple photographic guidelines.

Consider hiring a professional to photograph your work. Sure, it'll cost more, but the quality is likely to be better than you can produce yourself. And remember that the fee covers the photographer's expensive paraphernalia—lights, stands, lenses, backdrops—as well as his or her expertise.

If you take your own photos, you may be able to rent equipment from a local photo supply store. Be sure to use a color film matched to the type of lighting you're us-

ing. Tungsten lights (some photofloods and room lights) will require tungsten film. Strobe (flash) or available daylight requires daylight film—ask at a photo store if you're unsure of correct light/film match. Generally, the slower the film's ASA rating, the better. High speed films (ASA 400 and up) produce undesirable grain.

Keep the background simple. Photographer's seamless paper is, most often, the best choice, but some objects might photograph well in front of an uncluttered wall. Don't use a sheet, bedspread, wrinkled paper or any other backdrop that will visually compete with the subject.

Watch for harsh lighting and dark shadows. Direct sunlight, photofloods or camera-mounted direct flash will likely produce unpleasantly bright highlights or unwanted shadows. It's usually better to diffuse the light in some way. Daylight through a northern window, for example, is prefer-

able to direct sunlight. Similarly, photofloods and flash units should be diffused either through translucent screens or by bouncing them off reflective surfaces or photographic umbrellas.

Compose carefully to show the object from the best viewpoint. Straight-on composition works sometimes but, more often, views from slightly above and/or to one side best reveal a wooden object's true shape. A straight-on shot of a table, for example, might reduce it to a stark line supported by two rather than four legs.

Have your slides developed by a reliable company, then package them carefully for submission. Heavy gauge plastic sleeves with individual pockets are ideal—the slides are immediately visible and the sleeves are easy to file. We request that you use these for the *Design Book*. We will not accept cellophane or paper envelopes and cardboard or plastic slide boxes.



## Learn from a master craftsman.

Six years ago, TAGE FRID began work on a three-book series that would give woodworkers the information they needed to make fine furniture. The project is now complete, and like so much of FRID's work, it's a classic. *Each book is \$18.95 postpaid.*

**Book 1: Joinery:** FRID shows you how to make all the joints useful to cabinetmakers—from the simple tongue and groove to more complicated dovetails and multiple spline miters. *Publication #09*

**Book 2: Shaping, Veneering, Finishing:** FRID goes on to show you how to bend, carve, turn and inlay wood, how to work with plywood and veneer, and how to finish the pieces you make. He covers both fundamental skills and techniques complicated enough to challenge the most experienced craftsman. *Publication #19*

### NEW

**Book 3: Furnituremaking:** In this long-awaited conclusion to his series, FRID shows you how to make some marvelous furniture of his own design. He offers photos, instructions and complete working drawings for 18 pieces, including eight tables, his well-known workbench, his distinctive three-legged stool and much more. All the designs reflect FRID's belief that even the finest furniture is meant to be used. *Publication #43*

### Special Series Price

*All three books for just \$44.95 postpaid. Publication #90*

To order: Please use the insert after page 18 or call toll-free, 1-800-243-7252, and use your credit card.

## THE FINISHING TOUCH!!

as easy as 1-2-3  
with SEALACELL  
Penetrating Oil Wood Finish  
Wipe On - Dries Dust Free  
Small Kit - \$12.95  
Large Kit - \$19.95

VISA CALL TOLL FREE 1-800-341-0062 M.C.  
IN KANSAS 1-316-262-8485

We Ship Lumber - Continental USA  
CHOOSE FROM 40 SPECIES  
**Brush & Board  
HARDWOODS**  
923 E. Gilbert - Wichita, KS

## POWERMATIC

MODEL 66 - 10" TA SAW

5 H.P. 3 Phase or  
3 H.P. Single Phase  
48" Rails, Ext. Wings



**\$1569.00** FOB McMinnville

Order No. 1660760  
Biesemeyer Fence \$125 Extra  
#26 Shaper \$1,625

**WORKBENCH TOOL CO.**  
2833 Perry St.  
Madison, Wisconsin 53713  
1-800-792-3505 Ext. 233



THE SOURCE

AP-10

10"

PORTABLE

PLANER

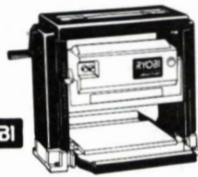

**\$369** Delivered

Send \$3.00 for the most COMPLETE catalog of  
fine hand tools & cabinet makers supplies !!!!!  
(refunded with first order)

7305 Boudnot Drive

Springfield, VA 22150

CALL TOLL FREE 800-452-9999 IN VA. 800-468-1778

## QUALITY MACHINERY!! - EXCELLENT PRICES!!

BUY FROM A LEADING IMPORTER.  
1 YR. WARRANTY-RETURN WITHIN 30 DAYS  
IF NOT SATISFIED.

<b>BANDSAWS:</b>	<b>JOINTERS:</b>	<b>TABLESAWS:</b>
14" - 28"	6" - 12"	10" - 14"
<b>\$275 - \$2695</b>	<b>\$295 - \$1650</b>	<b>\$325 - \$2295</b>
<b>PLANERS:</b>	<b>SHAPERS:</b>	<b>SANDERS:</b>
15" - 24"	1/2" - 2"	6" - 36"
<b>\$750 - \$2500</b>	<b>\$275 - \$2895</b>	<b>\$195 - \$8500</b>

**BIESEMEYER 50" COMMERCIAL  
SYSTEM - \$275**

We also carry many more machines not listed ie: Scoring  
Saws, Dust Collectors, Lathes, etc. Call and ask for details.

## ANDREU INDUSTRIES

22 69 23rd STREET ASTORIA, NEW YORK 11105

**(718) 278-9528**

MC / VISA

24 HOURS /  
7 DAYS A WEEK



# Your home workshop can PAY-OFF

# BIG...

Earn Extra Income  
Right At  
Home.

START  
YOUR OWN  
MONEY  
MAKING  
BUSINESS!

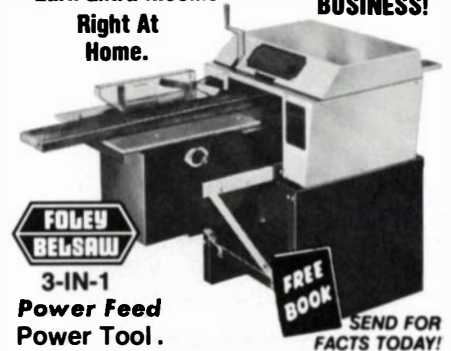

**Power Feed  
Power Tool.**

SEND FOR  
FACTS TODAY!

## Planer Molder Saw

**Three power tools in one —  
a real money-maker for you!**

The Planer/Molder/Saw is a versatile piece of machinery. It turns out profitable precision molding, trim, flooring, furniture . . . in all popular patterns. Rips, planes, molds separately . . . or all at once. Used by individual home craftsman, cabinet and picture framing shops, lumber yards, contractors and carpenters.

Never before has there been a three-way, heavy-duty woodworker that does so many jobs for so little cost. Saws to width, planes to desired thickness, and molds to any choice of patterns. Cuts any molding pattern you desire. Provides trouble-free performance. And is so simple to operate even beginners can use it!

**30-Day FREE Trial!** SEND FOR  
EXCITING FACTS  
NO OBLIGATION—NO SALESMAN WILL CALL

**RUSH COUPON  
TODAY!**

FOLEY-BELSAW CO.  
90819 FIELD BLDG.  
KANSAS CITY, MO. 64111

**FOLEY-BELSAW** **FREE BOOK**

Foley-Belsaw Co.  
90819 Field Bldg.  
Kansas City, Mo. 64111

YES, please send me the FREE Booklet that gives me complete facts about your Planer-Molder-Saw and full details on how I can qualify for a 30-Day Free Trial right in my own shop. I understand there is No Obligation and that No Salesman will call.

Name \_\_\_\_\_

Address \_\_\_\_\_

City \_\_\_\_\_

State \_\_\_\_\_ Zip \_\_\_\_\_

carefully controlled by handicapping branches that were growing too quickly.

In almost 40 years of patient work, Erlandson created a wonderland of fantastic trees in the shapes of ladders, spiral stairways, hub-and-spoke back chairs, a small cathedral, single and double hearts, a gothic archway, and innumerable free-form loop-the-loops, curlicues, and geometric patterns. He shaped sycamores, eucalyptus, redwoods, poplars, ashes, willows, birches, alders, cork oaks, box elders, mulberries, apples and loquats, all with dramatic success.

Unfortunately, for the trees, Erlandson was a better craftsman than a promoter. He had no interest at all in worldly enterprises. It was almost entirely due to the efforts of his wife, Leona, that Erlandson's masterwork achieved any commercial attention whatsoever. She conceived the idea of setting up the trees as a roadside attraction near Santa Cruz, Calif., and collecting 30 cents a head from people who pulled off the highway to see the

"Tree Circus," as the collection had come to be called.

The greatest publicity came when *Ripley's Believe it or Not* featured drawings of the trees ten times in an eleven year period. By the time *Life Magazine* did a story on the Tree Circus in January 1957, Erlandson had over 70 healthy specimens.

But luck withered away for the arboretum and Erlandson who, due to failing health and finances, was forced to sell his property and lifework in 1964 for a mere \$12,000. That same year, 79-year-old Axel Erlandson died.

The next 22 years were dismal for the Tree Circus, many of the trees perished from simple neglect and lack of water. Speculators came and went, most notably one who tried, unsuccessfully, to sell twelve of the trees to Disney World for the outrageous sum of three million dollars!

Perhaps the Circus' only friend during this period was a local architect named Mark Primack who dedicated himself to protecting and preserving the trees. Pri-

mack initiated legal and political action to stop a developer's bulldozer, organized fund raising events, and even rallied a troop of "guerilla gardeners" one dry summer morning to surreptitiously give the trees critically needed watering and attention.

As in fairytales, there is a happy end to this story. Last winter, supermarket-chain and nursery owner Michael Bonfante purchased and moved 28 of the best trees to a sort of botanical garden and park in the neighboring Gilroy hills. Eventually, he hopes to build a restaurant and have a narrow-gauge railroad transport visitors through the park on their way to eat. The dead trees were donated to the Santa Cruz City Museum, where they will be put on display.

It's somehow reassuring to know that the living creations of a man who once told children that he "talked to the trees" to get them to grow like they did, will live on to share their magic with future generations. —Sandor Nagyszalanczy

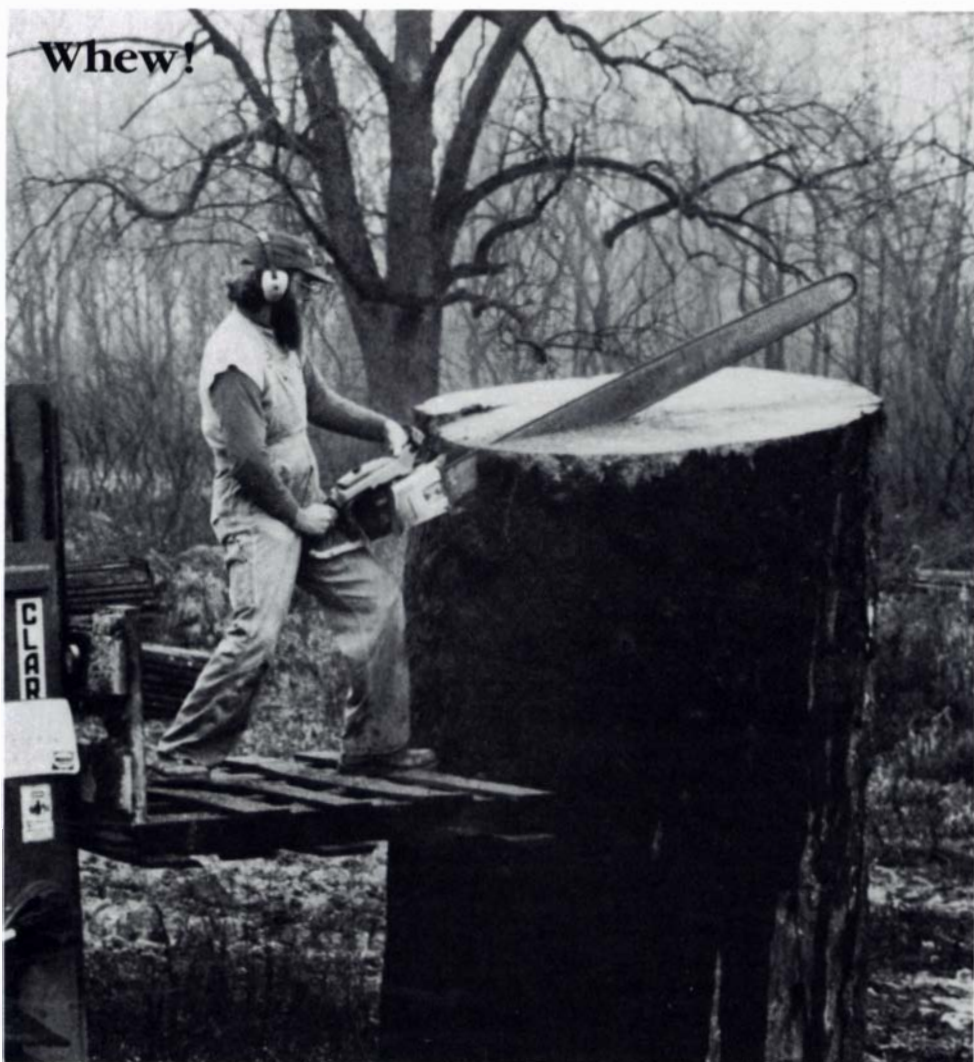

At some 6 ft. in diameter and 8 ft. long, this bubinga log tips the Doyle scale at about 4,800 bd. ft. So it can fit on the bandmill at The Sawmill in Nazareth, Pa., sawyer Bill Hall rips it through the heart with a Stihl 070 chainsaw and a 60-in. bar. "A 4-ft. log is fine. I like to cut those," says Hall. "But this gets to be too much." —Scott Landis

## Don Newell 1922-1986

Don Newell, consulting editor of *Fine Woodworking*, died last February after a long illness. Newell, of Farmington, Mich., was a finishes chemist who specialized in paints and varnishes. In addition to writing articles for the magazine and answering countless finishing questions in the Q & A column, Newell was invaluable as a behind-the-scenes consultant.

Over the years, Newell developed a considerable following among *FWW* readers; his contributions will be missed. Newell wrote two books on wood finishing: *Gunstock Finishing and Care* (1975, Stackpole Books, Harrisburg, Pa.), and *Fine Woodfinishing*, to be published in mid-1986 by Prentice Hall Press, 1 Gulf and Western Plaza, New York, N.Y. 10023.

## Build it cheaper and better yourself!

I always love those inspiring stories about the innovative woodworker who, with an old washing machine motor, a pair of pillow blocks that "just happen to be lying around the shop," and an old shaft and pulley, manages to cobble together some contraption that will "beat the daylight's outta one of them factory-built machines."

A few years ago I read a story like that in *Fine Woodworking*, in which a fellow described his low-tech drum sander. If I remember correctly, that sander cost him about \$20. Being nowhere near solvent enough to afford a planer, I figured by beefing-up his design I could make my-

# STONE MOUNTAIN

**POWER TOOL CORPORATION**  
6460 Buford Hwy. Doraville GA 30340  
(404) 446-8390

**TS-251U \$153.00 PPD**  
Accessory Kit \$15.00

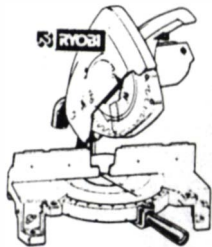

Blade diameter 10"  
Arbor 5/8"  
Input 120V, AC, 12.5A  
RPM 5,000  
Max cutting capacity  
at 90° HxW 3 1/8x4 3/4"  
at 45° HxW 3 1/8x4 3/8"

**AP-10 \$359.00 PPD**  
Extra Blades \$25.00

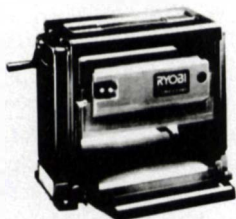

Input 120V, AC, 13A  
No Ld Spd 8000 rpm  
Planing feed rate 26ft/min

Mail & Phone Orders/MC Visa Check MO

## GENERAL



Saw Shown  
With Optional  
Motor Cover

- 350-1 10" Table Saw**  
3 HP. 1 ph. 230V Motor Magnetic Control \$1,395.00 ppd.  
1 1/2 HP. 115/230V 1 ph. Motor & Switch 1,175.00 ppd.  
**160-2 Var. Speed Lathe 1 HP.**  
115/230 1,140.00 ppd.  
**260-1 Var. Speed Lathe 1 HP.**  
115/230 Mag. Control 1,950.00 ppd.  
**1180-1 6" Jointer 1 HP. 1 ph.**  
115/230V Motor 785.00 ppd.  
**480 8" Jointer 1 1/2 HP. 1 ph.**  
115/230V Motor 1,440.00 ppd.  
**490-1 15" Band Saw w/base**  
1 HP. 115/230V Motor 895.00 ppd.  
**34-01 15" Floor Model Drill press**  
1/2 HP. Motor 495.00 ppd.  
**130-1 14" Planer 3 HP. 1 ph. 230V**  
Motor Magnetic Control 2,600.00 ppd.



4050 Williston Rd.  
So. Burlington, VT 05401 802-863-9036  
Freight included. Except Alaska & Hawaii

# Great Products - Great Prices!

## Don't Buy Powermatic until you've talked to us!

Model 66 10" Table Saw Call  
Model 26 Heavy Duty Shaper Call  
Model 60 8" Long Bed Jointer Call

We carry the entire line of Powermatic working machinery. Please call for the best prices available on these fine tools. FOB Factory.

## Introducing Mini-Max!

The Xylophile's Co. is proud to offer the Mini-Max line of woodworking machinery. Made to exacting specifications, we feel these tools represent the best value available to the advanced craftsman today. Please call or write for information on the complete line of Mini-Max machinery.

Listed below are specs on two Mini-Max machines. Examine these and see if you don't agree with us.

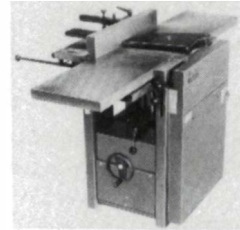

**FS-35 Jointer-Planer**  
Table Width 13 1/2"  
Table Length 63"  
Weight 719 lbs.  
3 HP, 1 PH or 3 PH Motor  
Magnetic Controls  
Cast Iron  
**\$2095.00** Freight Collect

## MACHINERY

2030N MAKITA jointer/planer CALL  
2040 MAKITA 15-5/8 planer CALL  
F1000-A HITACHI jointer/planer CALL  
P100F HITACHI 12" planer CALL  
CB75F HITACHI bandsaw CALL  
HC260 ELEKTRA BECKUM jtr/plnr CALL  
TF100 ELEKTRA BECKUM shaper CALL  
SP1000 ELEKTRA BECKUM dust clr. CALL  
M/MX-2 HEGNER precision saw CALL

**S45 Bandsaw**  
18" Throat Depth  
10.8" Resaw Capacity  
330 lbs.  
1.5 HP Motor  
Table Tilts to 45°  
Cast Iron  
**\$1049.00** Freight Collect



Prices Valid thru June 30, 1986.

## MAKITA

B04510	4" finishing sander	\$ 47.00
DP3720	3/8" var/rev. drill	49.00
1100	3/4" planer kit	164.00
1900BW	3/4" planer kit	94.00
1805	6 1/2" planer kit	264.00
2708	8 1/4" table saw	209.00
LS1000	10" miter saw	229.00
3612BR	3HP plunge router	177.00
GUIDES	for 3612BR	20.00
3601B	1/2" router	119.00
3608BK	3/4" router	86.00
3700B	1/4" trimmer	83.00
4301BV	orbital jig saw	127.00
5007NB	7 1/4" circular saw	98.00
5008NB	8" circular saw	109.00
5201NA	10 1/4" circular saw	220.00
5204	16" circular saw	369.00
6000R	3/8" clutch-drill	105.00
6000LR	low speed uni-drill	119.00
6010DWK	3/8" cordless drill	89.00
6012HDW	3/8" cordless clutch drill	109.00
6510LVR	3/8" low speed drill	69.00
9900B	3 x 21 belt sander	119.00
9924DB	3 x 24 belt sander	129.00
9401	4 x 24 belt sander	159.00
9045N	1/2 sheet finish sander	104.00
9820-2	blade sharpener	159.00
DP4700	1/2" var/rev. drill	92.00
6010SDW	3/8" cordless drill	49.00

## MAKITA 8" JOINTER!! HALF-PRICE!!



Model 2020

**\$925.00**

### SPECIFICATIONS:

8" wide; 60" long; 2 HP. 110V motor; rack and pinion fence adjustment; both infeed and outfeed tables adjustable.

We have obtained a limited supply of Makita's new 8" jointer at an incredible price. This machine lists at \$1700, but we are offering them for \$925 (includes freight), nearly a 50% savings.

Don't miss this opportunity to own an 8" long-bed jointer at a fantastic savings. Remember, quantities are limited.

This offer expires June 30, 1986.

## MISC.

Biesemeyer fences	Call
" bladefinders	115.00
Watco Gal.	17.00
Shophelper	75.00
Jorgensen 3/4" pipe clamps	\$40/6

## FREUD

WC-104	4 pc chisel set	\$ 20.00
WC-106	6 pc chisel set	28.00
WC-110	10 pc. chisel set	48.00
CS-106	6 pc. carving set	57.00
CS-112	12 pc. carving set	107.00
CM-100	carver's mallet	8.95
TT-108	8 pc. turning set	52.00

### SAWBLADES

LM72M	10", 24t, flat top rip	34.00
LU73M	10", 60t. ATB cutoff	34.00
LU84M	10", 50t. smooth comb	36.00
SET	ALL THREE ABOVE	103.00
LU82M	10", 60t. triple chip	42.00
LU85M	10", 80t. super blade	59.00
DS306	6", dado 1/4"-13/16"	92.00
DS308	8", dado 1/4"-13/16"	102.00

ROUTER BIT SET 15 Piece 134.00  
Carbide Set with Wooden Box

### SHAPER CUTTER SALE

Economy Raised Panel Cutters 79.00  
EC-260 3/4" Cabinet Door Set 184.50  
EC-270, EC-274 Door Sets 210.00

We carry the entire line of Freud Shaper cutters and route bits at discounts up to 30%. Please call for prices on these items.

## RECORD

<b>BENCH PLANES</b>		
04	Smooth Plane	\$34.00
05	Jack Plane	40.00
07	Jointer Plane	60.00
Set of Three Above 129.00		

### VISES

52 E/D	52.00
52 1/2 E/D	78.00
53E	84.00

**ORDER TOLL FREE**  
**1-800-354-9083**  
IN KENTUCKY CALL  
**(606) 254-9823**

138  
THE  
**Xylophile's**  
COMPANY  
138 E. Loudon Avenue • Lexington, KY 40505



MAIL ORDERS: Simply enclose your check or money order with a note describing the item(s) desired. Ky. residents please add 5% sales tax. We will ship right away.



on orders of \$35 or more **PRICES INCLUDE SHIPPING** otherwise please add \$1.95 shipping  
TO THE CONTINENTAL U.S.  
EXCEPT AS NOTED ABOVE

self what would amount to a low-tech abrasive planer. I looked around my shop for those old pillow blocks, but found none. When I went to buy a pair of them, I discovered they cost \$25 each.

The old shaft that I couldn't find cost about \$15 from a machine shop: a couple of dollars for the material, about that much again to cut it to length, and \$10 for the keyway in one end. I was also informed that I didn't really want a pulley for my machine, I really wanted a *sheave* and a *bushing*. The article hadn't said anything about all this. The nice fellow at the machine shop (the one who gave me the deal on the shaft) fixed me up with a sheave, bushing and belt for only \$22. My \$20 sander was getting kind of expensive.

After I got the whole thing together, I found it had some problems: The dust was terrible, those abrasive strips you wrap around the drum were not that easy to come by, and the drum itself—plywood circles turned round by means of heavy-grit sandpaper put under the drum after assembly—never got quite round. Somehow we got along without the abrasive planer. . . .

Around this time, my partner and I began following a raging debate in the pages of *Fine Woodworking* about 3-phase motors. Having recently acquired a number of these ancient industrial motors, we decided to go the 3-phase route. There are several possible solutions to the problem of converting single-phase current to 3-phase. The most obvious—just go buy a converter—we ruled out immediately. It was too expensive and we had that do-it-yourself spirit. All you had to do, it seemed, was get

one motor going and that lets you generate the third leg of current to get your other motors going. Sounded simple.

After we tried the method where you get that first motor going with your foot, we decided to get subtle and go for some running capacitors instead. We also decided to invest \$130 in a used 10-HP motor to make sure our converter could handle those 5-HP motors on the jointer and radial-arm saw. Finally, after re-reading all the available information and being told we were crazy by the personnel at the local electrical supply house, we wired up the capacitors so that we could let off their switch when the motor doing the converting got going. Unfortunately, this switch was a push-on/push-off type. When we let off the switch, the capacitors kept running, a terrible noise came from the 10-HP motor and the shop rapidly filled up with black smoke. Fortunately, the capacitors were only ruined and didn't explode and a local salvage man relieved us of the burned-out motor. A few months later we got another large motor, more capacitors and figured out the switch. The jointer and radial-arm saw work just fine now.

My next build-it-yourself shouldn't really count as one since it was a kit—this time for a shaper. After looking at ads for every make of ½-in. spindle shaper, the kit for \$69 seemed like the best buy. I happen to live near the kit manufacturer, so I went to see their demonstration model, which looked acceptable. I bought the quill and fence for \$69. But then I needed a switch and cord. And then the motor and another pulley and a belt, and finally, the cutters.

Some \$240 later, plus the time and materials to build the cabinet, I have a serviceable shaper—it cost a little more than the cast-iron imports, but I made it myself.

Most recently, I got disgusted with the ripping capacity of our light-duty tablesaw and figured, once again, "How hard can it be to build my own?" This time I actually had one of the parts lying around: a mandrel that looked like it would be perfect for a saw. The shaft, however, was bent and that made the blade wobble. So, I bought another mandrel, and it wobbled too. What I needed, I realized, was a couple of pillow blocks and a shaft with some threads turned on the end. But this time, I thought, I have some pillow blocks just lying around because I bought them for the drum sander I never use. I robbed the sander of its bearings and, for a mere \$80, I got the shaft made up (yep, same machine shop—this woodworker learns no new tricks. . .) and bought a pulley and belt. Tired of being underpowered, I wired up one of my 3-phase, 3-HP motors to my new saw and switched it on and off with an old fuse box. If I ever figure out how to get the fence parallel to the blade, I'll start doing some serious ripping.

But wait, the best is yet to come. I have this great idea for a small molder. I'll just get some more pillow blocks and a shaft, and figure out a way to make the table move up and down, and then just work out a few more problems like hold-downs and power feed. Just think how much I'll save, and heck, it can't be that hard to build a little molder. . . .

—Roy Day, St. Louis, Mo.

## Product review

**Parks jointer/planer**, Parks Woodworking Machinery Co., 1501 Knowlton St., Cincinnati, Ohio 45223.

Some time ago we needed a planer at the Art Academy of Cincinnati, where I'm the shop technician. We had a jointer, but no room for a planer, so a combination machine made sense. On the basis of Jim Rome's comparison of combination jointer/planers (*FWW* #43, pp. 42-48), I looked seriously at the Makita, Inca and Hitachi machines. However, since I live in Cincinnati, the home of the Parks Woodworking Machinery Co. for almost 100 years, I decided to take a look at their Model 11 jointer/planer. Despite costing from \$600 to \$1,000 more than the others, I liked it so much that I bought one for the shop.

Parks developed the Model 11 from their workhorse, the Model 95 12-in. by 4-in.

*The Parks Model 11 jointer/planer is a sturdy, reliable spacesaver, ideal for a small, heavily used workshop.*



thickness planer. They mounted the jointer tables right on top, creating an over-under type of machine. What sold me on the Parks is that, although it is designed for small-shop use, it is a production tool, capable of planing or jointing up to ⅜ in. off a full 12-in. width of virtually any type of wood all day long for years and years.

Virtually unchanged since its introduction in 1948, the Model 11 has a heavy, well-ribbed cast-iron frame and cast and machined tables. The three-knife cutterhead (one more knife than the competition) generates 75 cuts per inch at a feed rate of 16 ft. per minute. Cutterhead knife slots are fitted with "micro-adjusting screws" that raise and lower each knife, which eases set-up.

Parks offers a wide range of motors, from a 1½-HP, 115/230-volt, single-phase motor, up to a 3-HP, 220/440-volt, 3-phase. My 2-HP, 220-volt, 3-phase motor operates very quietly and takes a full width, ⅜-in. deep cut off hardwood (oak, walnut, cherry and maple, so far) without bogging down. Op-





# THE THREE WAYS MR. SAWDUST CAN SERVE YOU BEST!

Our 800-number is YOURS!

For the answers to *any* woodworking, tool, or shop problem, PHONE US. Want an opinion *before* you buy a new or used machine? Want to know the *best* radial saw to buy? Take advantage of the mistakes we've *already* made. We want to help you.

## The Mr. Sawdust Guarantee

With every product we sell, you have 30 days to prove your complete satisfaction in your own shop and a 5-year warranty on the product itself. We work to *your* advantage at all times. No questions asked!

## 1. My All-New MR. SAWDUST BLADE is now only \$79.50 (or less) — and the Dampener is FREE!



MR. SAWDUST 1 for Your Radial Saw	MR. SAWDUST 2 for Your Table Saw
10", 60T .. \$79.50 (5" Dampener Free!)	10", 40T .. \$79.50 (5" Dampener Free!)
9", 60T .... 76.00 (4" Dampener Free!)	9", 40T .... 76.00 (4" Dampener Free!)
8", 60T .... 72.50 (4" Dampener Free!)	8", 40T .... 72.50 (4" Dampener Free!)

Also available: LARGER-size blades. Plus Mr. Sawdust 8" Dado — Only \$175.00. (Shipping: \$2.50 for any of the above.)

One blade makes ALL cuts — PERFECT cuts — in any God-made or man-made wood. (Or plastic.) Gives you *years* of precision cutting. ORDER YOURS ... TODAY! Your first cut will show you *why* my blade is the most desired among our serious woodworkers!

## 2. NOW SHIPPING! My New-Twist Shaper Cutters for Radial-Arm Saws!



Over 70 profiles! LOW Cost! A revolution in shaping for the serious woodworker!

## PHONE FOR YOUR FREE SHOP POSTER ... NOW!

TOLL FREE: 1-800-932-0051  
In NJ: 201-850-3501

(Complete with full-size profiles, prices and new Shaper/Dado Guard info.)

## 3. My MR. SAWDUST SHAPER/DADO GUARD! For Sears or DeWalt Radial-Arm Saws!

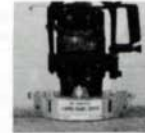

### ◀ HORIZONTAL!

Massive rim adjusts to surface of material. Required SAFETY for shaping, rabbeting or slotting with 8" dado or saw blade.

### 45°-TILT POSITION! ▶

Hold-down shoes ride on material! A new kind of SAFETY when molding with New Twist cutters. V-grooving with dado, bevel-ripping with 8" blade.



### ◀ 90°-"RIP" POSITION!

Hold-down shoes eliminate radial-saw's worst hazard: *Lifting the material!* Essential for SAFE molding, ploughing and ripping. DON'T TRUST TO LUCK!

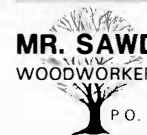

## MR. SAWDUST, INC.

WOODWORKERS INVESTING IN WOODWORKERS

P.O. Box 4, Schooley's Mountain, N.J. 07870

## INDEX TO ADVERTISERS

ACC Conference	101	Dowel Craft	107	Kirby Studios	8	Sand-Rite	92
Acme Electric	86, 99	Dupli-Carver	83	Kuster	21	The Sawmill	93
Adams Wood Products	22	Ebac Lumber Dryers	85	Kwikot Equipment	17	Sawhelper	28
Addison Hardware	99	Econ-Abrasives	11	Robert Larson Co.	25	Seven Corners	82
Allen Specialty Hardware	22	Educational Lumber	90	Laser Machining	92	Silverton Victorian Mlws	84
Amana Tool	7	Elektra Beckum U.S.A.	92	Leeds Design Workshops	9	Singley Specialty	101
American Woodcrafters	95	Fine Tool Shops	103	Leigh Industries	25	Sisco Supply	111
The American Woodworker	86	Fisher Hill Products	91	LeNeave Supply	95	The Source	109
AMI	24	Floral Glass & Mirror	11	Lignomat USA	93	Sperber Tool Works	83
Andreou Industries	109	Foley-Belsaw Co.	109	Lignum Press	9	Sterling Equipment	5
Armor Products	103	Forrest Mfg. Co.	28	Lyon Electric	99	Stone Mountain	111
Arrowmont School	8	Freeborn Tool Company	25	Manny's Woodworker's Place	92	Strong Tool Design	107
Ashman Technical	21	Freud	2	Mason & Sullivan	22	Sunhill	102
Aviation/Industrial Supply	85	Frog Tool	94	Miami University	8	Swanger Brothers	99
Ball & Ball	92	Furniture Designs	104	MLCS	18	The Taunton Press	19, 20
The Bartley Collection	103	Furmima Industrial Carbide	22	Model Expo	13	Tool City	107
Berea Hardwoods	18	Garrett Wade	88	Morse Design	95	Tool Shed	107
Brady Corp.	90	Grizzly Imports	29, 115	Mr. Sawdust	113	Eli Townsend & Son	13
Bratton Machinery & Supply	84	Hamilton Electric	5	Native American Hrdwds	88	Trend-Lines	89
Brush & Board Hardwoods	109	Hardwoods of Memphis	101	Nicolaysen Art Museum	5	Vega Enterprises	18
Buckeye Saw	95	Headland Intl.	93	Nova Tool	88	Versatile Saw	21
Bucks County Comm. Coll.	9	Hida Japanese Tool	103	Nyle Corp.	22	Wall Lenk	104
Calculated Industries	83	Highland Hardware	101	Oregon School	8	Wertz Do-It Center	24
California College	9	Hiller Hardware	100	Paralok	5	Wetzler Clamp	83
Cane & Basket Supply Co.	104	Home Lumber	18	Parks Woodworking Machine	101	Wilke Machinery	91
Capitol Carbide	90	Horton Brasses	99	Paxton Hardware	83	Wood-Mizer	95
Cascade Precision Tool	94	Hot Tools	5	Penland School	9	Woodcraft	104
M. Chandler & Co.	92	House of Tools	90	Philipps Bros. Supply	93	Woodmaster Power Tools	90
Cherry Tree Toys	94	HTC Products	86	Pootatuck	90	Woodmere Saw & Tool	93
Classified	96, 97, 98	Hubbard Harpsichords	84	Primrose Center	9	Woodshop Specialties	87
Colonial Saw	13	J. Philip Humfrey	103, 104	Pro Shop	94	Woodworking Designs	17
Comput-O-Disk	84	Imported European Hardware	94	Pro Tools	87	Woodworker's Supply	15, 95
Maurice L. Condon	25	Industrial Abrasives	24	Quest Industries	93	Woodworking Show	100
Constantine	101	Intl. Woodworking Equip.	13	RBI	95	Woodworking World	9
Craftwoods	22	W.S. Jenks & Son	105	Reliable Grinding	87	Worcester Craft Center	8
Dallas Wood & Tool Store	88	Jesse Jones Ind.	90	Reproduction Hardwoods	83	Workbench Tool	109
Deft	22	Kassner Woodcraft	88	Ring Master	83	Xylophile's Co.	21, 111
Delmhorst Instrument	18	Keller Dovetails	103	Roger A. Reed, Inc.	17	Yukon Lumber	107
Delta	27	Kenco Safety Products	84	Ryobi	23	ZAC Products	91
DML	85	Kingstown Tool	24				
Donald Durham Co.	88						

erating the planer is a dream because of the power and accuracy. Feed rolls are solid machined steel; the infeed roller is fluted. Feed rolls and pressure bar are spring loaded, and there are bed rollers—an advantage when planing rough stock. The thickness gauge is easy to read and there's a handle to stop the feed rollers.

The jointer has some design flaws, however. The tables are only 33 in. long overall, which means that taking the crown out of a long edge requires a lot of eyeballing. The tables are also mounted in a way that makes adding extensions difficult. Free-standing rollers, therefore, are needed to handle long boards. There's no depth-of-cut gauge, raising and lowering the infeed table is awkward, and it's not always dead parallel with the outfeed table afterward, so I usually leave it set to take a 1/32-in. cut.

The cast-iron fence tilts, slides and is accurate, but is attached only to the infeed table so it flexes at the outfeed end. The knife guard is manually operated—loosen a handle, slide the guard over, then tighten the handle—and I had to fabricate a guard to cover the knives exposed behind the fence. Against these drawbacks, however, is the jointer's 12-in. capacity—face-jointing wide boards is easy.

Chips are a problem. Planer chips fly out the top and jointer chips fall onto the planer table. I made a hood for a vacuum collector for the planer; a box placed on the planer tables does the trick for the jointer chips.

The Model 11 includes the basic machine, floor stand, belt guard, pulleys, belts and motor. Its price varies from about \$2,200 to \$2,400, depending on the type of motor and starter you select. (Parks also sells just the basic machine for \$1,660.) The price doesn't include shipping, which is F.O.B. Cincinnati. Machines can be ordered through dealers as a non-stock purchase, or directly from Parks. The machine isn't cheap, but if you want to face-plane and thickness stacks of wide, rough-cut wood with ease and accuracy (and if you're willing to fool around with jointing long edges) or if you simply like old-fashioned machines built to last a lifetime or two, consider the Parks.

—Jeff Thomas-Arnold, Cincinnati, Ohio

## It can happen to you . . .

*A while back reader Ken Knowles of Dallas, Texas, sent us a clipping from the November 14, 1985, Dallas Morning News. It was, to say the least, compelling reading. So much so that we got permission from the Morning News to reprint reporter Pat Gordon's account here.*

Neoma Patterson figured her chances of survival were nil when she saw her left arm—severed by a radial-arm saw—lying on a table in front of her.

But the 56-year-old nurse, alone at home at the time, kept her head and in doing so saved her life . . . and her arm.

"I knew I was going to die," said Mrs. Patterson. "I didn't feel anything when my sleeve got caught, but I looked and there was my arm on the table and blood was spurting everywhere. I said, 'Please, Lord, help me put my mind in order so I can get help.'"

Mrs. Patterson had taken advantage of an extra day off from her job as a doctor's nurse to work on a combination greenhouse and birdhouse, which she and her husband are building near their rural home in Parker County. She was cutting 2x4s when an unbuttoned sleeve on her flannel shirt became caught in the sawblade. Her arm was severed just below the elbow.

"I took my shirttail and wrapped my arm in it," Mrs. Patterson recalled of the Nov. 5 accident. "Blood was flying everywhere, so I took my right index finger and punched it into the artery."

Cradling her severed arm, she walked about 50 yards to her house. She kicked the telephone receiver to the floor, knelt and released the artery long enough to dial "O."

Afraid that the operator would refuse to make an emergency call for her, Mrs. Patterson pleaded, "Ma'am, please don't get tacky with me. I have severed my left arm completely and I'm bleeding to death. I need an ambulance bad."

"I didn't hear anything, but silence," Mrs. Patterson continued. "I thought, 'Lord, she's cut me off.' Then, the sweet-

est voice I ever heard said, 'I've dispensed the ambulance. It will be there right away.'"

Even then, Mrs. Patterson worried that she wouldn't survive. She left the telephone to sit on her patio and wait. Death, she said, seemed likely to arrive before help.

"I talked continuously out loud," Mrs. Patterson said. "I knew if I hushed, I'd die."

Her voice broke frequently from tears as she recalled the accident. The memory, she said, was more frightening than the reality.

"There was no time to think about it then," said the mother of two grown children. "Everything had to be in place or I wouldn't be here today."

Mrs. Patterson credits "guidance from above" for her life.

Doctors credit her strong will. Her perseverance definitely saved her arm, said Dr. Luiz Toledo, a hand specialist who coordinated the arm-reattachment surgery.

"Fortunately, she knew how to take care of it (the injury)," Toledo said. "Things worked out good for her. She's a very strong person."

Although her arm isn't functional yet, surgeons believe it will be. Toledo said Mrs. Patterson should be able to move her hand in about four months and regain feeling in her fingertips in about a year.

Mrs. Patterson has no doubt that she will eventually return to her hobby as a carpenter. She grew up using the radial-arm saw, which belonged to her dad, she said.

"My son says I won't ever use it again. He cut off the controls (after the accident)," she said. "When my left hand works again, I'm sure I'll use the saw again. But the next time, I won't be wearing a loose-fitting shirt."

*Mrs. Patterson told us in February that she was doing well. Unable to feel or move her arm yet, she is in therapy three times a week and the doctors say she should be able to use the arm within three years. She is woodworking again, though without the radial-arm saw, and she has completed the greenhouse and birdhouse.*

## Bandsaw banter

The bandsaw is probably the least understood and most abused tool in the shop. We receive more questions and complaints about bandsaws than any other machine: They won't resaw or even cut a straight line. They bog down, shed blades, shimmy around the floor and bob their heads like a strutting pigeon.

We would like to hear from readers,

both professional and amateur, on the subject. What make of bandsaw do you have, and what do you use it for? Does it live up to your expectations? Do you have any favorite tricks? Would you recommend your machine to a friend? Later this year we'll publish a look at the modern bandsaw, from tiny three-wheelers up to 20-in. powerhouses, and we will include the results of this informal reader survey at that time. □

### Notes and Comment

*What's new in woodworking in your area? Notes and Comment buys brief articles about interesting events, shows and people and welcomes all manner of commentary. Send manuscript, if possible with color slides or black-and-white photos (preferably with negatives), to Notes and Comment, Fine Woodworking, Box 355, Newtown, Conn. 06470.*

# PRICE BREAKTHROUGH!!

We have negotiated a huge purchase of high quality Jointers, Tablesaws and Slow Speed Grinders with the factories overseas and have discounted them to a point where we are making very little money! The reason? To introduce ourselves to customers who have not yet dealt with us and to impress upon people out there that you do get quality for low prices. We use past customers as references (that shows our confidence in our products) and we carry a full stock of replacement parts right here in our Bellingham warehouse. In fact, our parts department is so extensive and efficient that in many cases we can supply an imported replacement part faster than a U.S. supplier selling a U.S. made product. Try us — we'll surprise you with courtesy and efficiency and we ship real fast — usually the same day.



## THE ULTIMATE 6" JOINTER!

NEW & IMPROVED MODEL

CHECK OUT THESE INCREDIBLE FEATURES:

- ★ 3 Blade, all ball-bearing cutterhead
- ★ Maximum depth of cut is 1/2"
- ★ 1 H.P. Single Phase, all ball bearing motor
- ★ Super heavy duty, center mounted fence is 4" x 29 1/4"
- ★ Table size is the longest in the industry — 7 x 47"
- ★ Tables are precision ground, cast iron
- ★ Both infeed and outfeed tables have quick adjustment levers making changes in table height an absolute breeze
- ★ Steel stand has built-in chip chute
- ★ Shipping weight is a hefty 280 lbs.

REGULARLY PRICED AT A LOW \$325.00

**MODEL G1182 — PRICED BEYOND BELIEF — ONLY \$295.00 F.O.B. BELLINGHAM!**

## 10" HEAVY DUTY TABLESAW!

The most essential machine in woodworking, this is another best seller that has exciting features.

- ★ Precision ground cast iron table and wings
- ★ Table size is 41" x 27" set up with wings
- ★ Motor size is 1 1/2" H.P. single phase
- ★ Rip fence quick locks front and back and has micro-knob for fine adjustment
- ★ Table has T-slots for miter gauge
- ★ Miter gauge, regular insert and dado insert included
- ★ Weighs a solid 235 lbs.

REGULARLY PRICED AT \$325.00

**MODEL G1022 — ANOTHER INCREDIBLE PRICE  
ONLY \$295.00 F.O.B. BELLINGHAM!**



**CALL US FOR DISCOUNTED FREIGHT RATES ON ABOVE 2 ITEMS.**



## SLOW SPEED GRINDERS

This excellent unit comes with two stones: one 10" x 2" stone that turns at only 60 R.P.M. (partly submerged in water) and one smaller stone 4 1/2 x 3/4" that turns around 3000 R.P.M.

**A MUST FOR EVERY SHOP**

REGULARLY \$129.50

**NOW ONLY \$99.50 PREPAID TO YOU**

 **IMPORTS, INC.**

THIS OFFER IS  
SUBJECT TO  
WITHDRAWAL AT  
ANY TIME.



GLADLY ACCEPTED

P.O. BOX 2069, BELLINGHAM, WA 98227 • PHONE (206) 647-0801 • SEVERAL LINES!



## THE TREE CIRCUS

Unlike most of us, Axel Erlandson preferred to do his woodworking with live trees. For almost 40 years, Erlandson bent, grafted, split, bound and coaxed trees into extraordinary shapes. When he died, in 1964, Erlandson's roadside tree circus near Santa Cruz, Calif., contained more than 70 specimens, a few of which are shown here. Though many of the trees died of neglect in the decades after Erlandson's death, 28 have recently found a home in a nearby botanical garden and park. For more on Erlandson (who is shown above sitting in one of his creations), his techniques and his creations, see p. 108.